







Assembly Instruction

ITEM NO. 8235GY/SS-3

SOFA

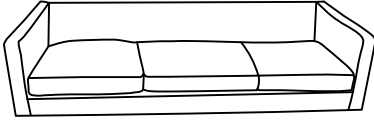
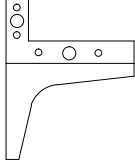
NOTE: Do not use power tools for assembly. Power tools increase the risk of over tightening which lead to splitting or cracking the wood.

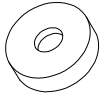
PARTS LIST

NO.	DRAWING	QTY	DESCRIPTION
A		3	BACK CUSHION
B		1	SEAT
C		4	METAL LEG
D		8	BOLT (3/5' *1-1/5')
E		8	WASHER (4/5' *4/5')
F		1	ALLEN KEY (1-1/5' *3-1/5')
G		1	PLASTIC CENTER SUPPORT LEG

Please follow the drawings below to assemble the item.

Step 1: Legs are stored in the non woven bag at the bottom of love seat, please take out for assembly.

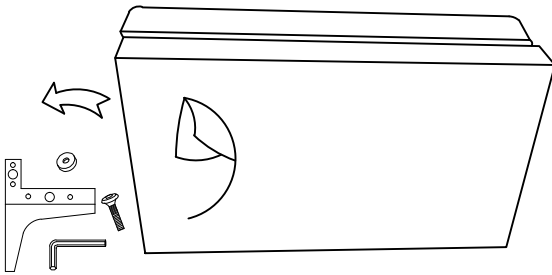

Step 2. Align the legs onto the pre-drilled holes at the bottom of the unit, insert bolts and washers then tighten with Allen Key.

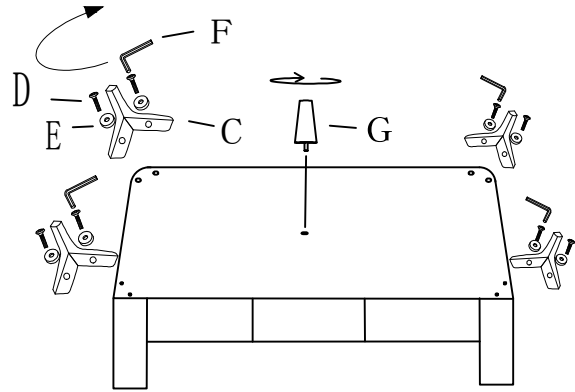

Step 3. Attach the back cushion onto the back rest and fix in the position properly.

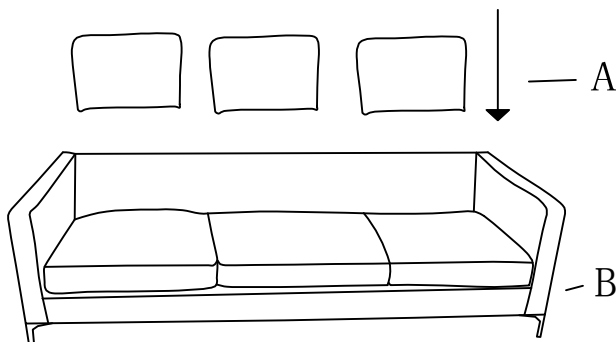

Step 4. Completed.

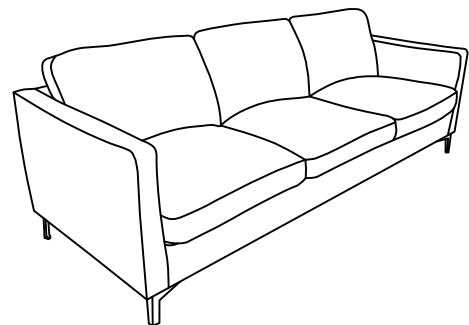

CARE INSTRUCTION FOR 100% POLYESTER FURNITURE:

- Avoid exposing furniture directly to sunlight or heating and air conditioning outlets. Exposure to sunlight or heating and air conditioning outlets will fade/damage 100% Polyester .
- Wipe gently with a damp soft cloth to remove dust, dirt and any grime buildup.
- Wipe the 100% Polyester with professional cleanser.



For items use on wooden floor, hard surfaces or carpets, it is recommended to Install protective pads under all legs and supports to avoid/prevent from damages/scratches and discoloration.