



FUEL INJECTION PERFORMANCE KIT

**FIPK**

GENERATION II™

## INSTALLATION INSTRUCTIONS

### 57-3050

#### CHEVROLET / GMC / CADILLAC

Silverado/Sierra Classic 1500  
 2007 V8-4.8L, 5.3L  
 Silverado/Sierra Classic 1500  
 2007 V8-6.0L  
 Silverado Classic SS  
 2007 V8-6.0L  
 Sierra Denali Classic  
 2007 V8-6.0L  
 Silverado/Sierra  
 2005-06 V8-4.8L, 5.3L  
 Silverado SS  
 2005-06 V8-6.0L  
 Tahoe/Yukon  
 2005-06 V8-4.8L, 5.3L  
 Suburban/Yukon XL  
 2005-06 V8-5.3L  
 Yukon Denali / Denali XL  
 2005-06 V8-6.0L  
 Sierra Denali  
 2005-06 V8-6.0L  
 Avalanche  
 2005-06 V8-5.3L  
 Escalade  
 2005-06 V8-5.3L  
 Escalade  
 2006 V8-6.0L  
 Escalade EXT/ESV  
 2005 V8-6.0L

NOTE: This kit was not designed to fit vehicles with a body lift.

#### TO START:

1. Turn the ignition OFF and disconnect the vehicle's negative battery cable.

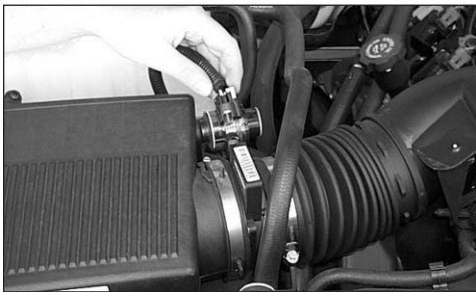

2. Disconnect the mass air sensor electrician connection.



3. Loosen the hose clamps at the throttle body and at the mass air sensor, then remove the factory intake tube as shown.



4) Pull firmly upwards to release the air cleaner assembly from the mounting tray grommets, then remove the assembly.  
NOTE: K&N recommends that customers do not discard factory air intake.

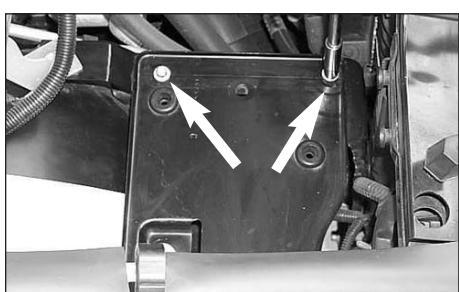

5. Loosen and remove the two air cleaner mounting tray bolts as shown.

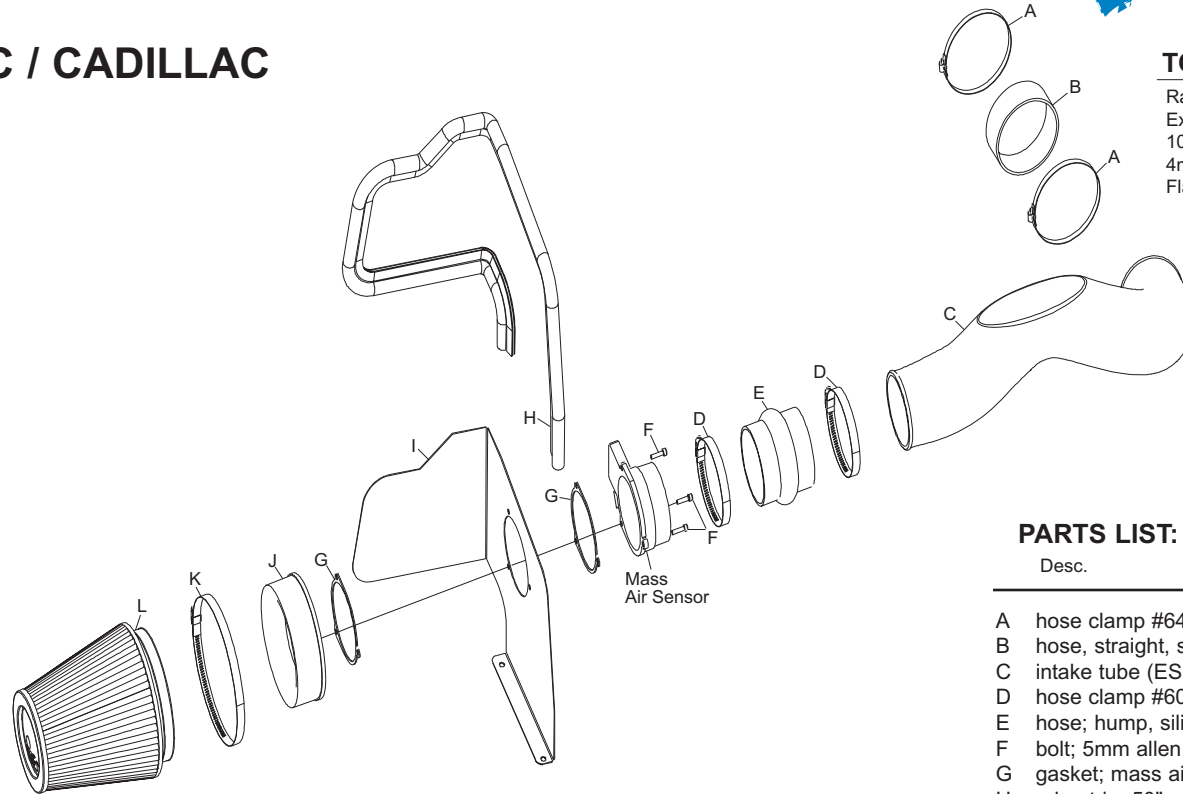

#### TOOLS NEEDED:

Ratchet  
 Extension  
 10mm Socket  
 4mm Allen Wrench  
 Flat Blade Screw Driver

#### PARTS LIST:

Desc.	Qty.	Part #
A hose clamp #64	2	08648
B hose, straight, silicone	1	08625
C intake tube (ES)	1	087160
D hose clamp #60	2	08628
E hose; hump, silicone	1	08176
F bolt; 5mm allen	3	08320
G gasket; mass air sensor	2	09033
H edge trim 50"	1	102481
I heat shield	1	07451
J adapter #240	1	08783
K hose clamp #104	1	08697
L air filter	1	RF-1041

NOTE: FAILURE TO FOLLOW INSTALLATION INSTRUCTIONS AND NOT USING THE PROVIDED HARDWARE MAY DAMAGE THE INTAKE TUBE, THROTTLE BODY AND ENGINE.



6. Loosen the hose clamp and remove the mass air sensor from the air cleaner.

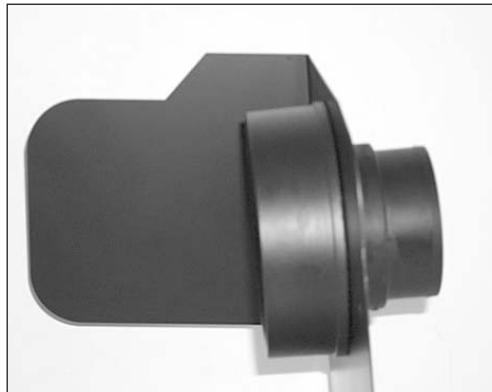

7. Assemble the mass air adapter, heat shield, gaskets and the mass air sensor as shown above.



8. Apply the trim seal to the heat shield assembly as shown.

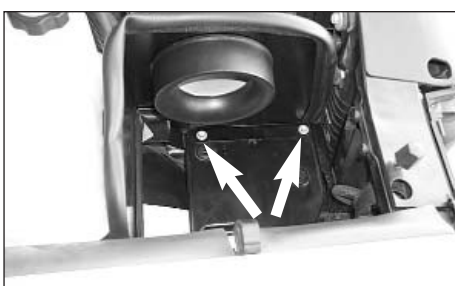

9. Install and mount the heat shield assembly to the air cleaner mounting tray using the bolts removed in step 5.



10. Install the silicone hose (08625) and hose clamps onto the throttle body as shown.



11. Install the silicone hump hose (08176) and hose clamps onto the K&N intake tube as shown.



12. Install the K&N intake tube onto the mass air sensor, then secure the other end onto the throttle body as shown.

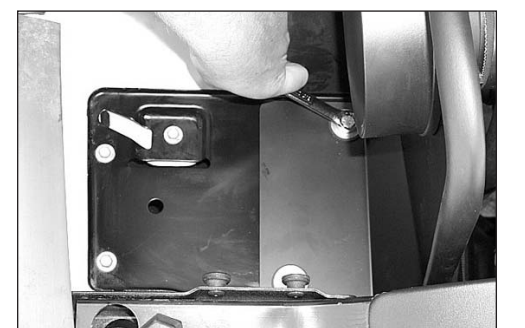

13. Adjust the heat shield and intake tube for best fit, then tighten the two hex bolts as shown.

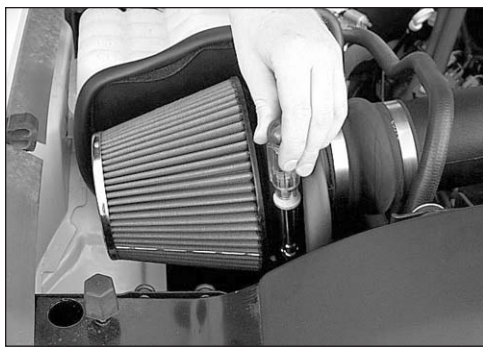

14. Install the K&N air filter onto the heat shield assembly as shown.

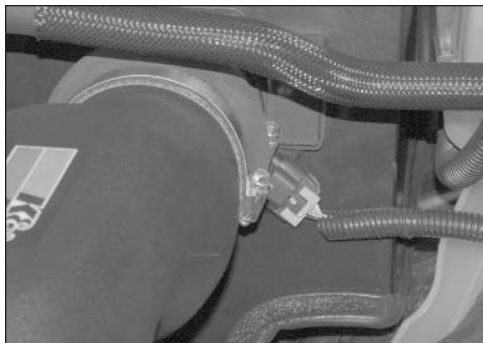

15. Reconnect the mass air sensor electrical connection as shown.



16. Reconnect the vehicle's negative battery cable. Double check to make sure everything is tight and properly positioned before starting the vehicle.

17. The C.A.R.B. exemption sticker, (attached), must be visible under the hood so that an emissions inspector can see it when the vehicle is required to be tested for emissions. California requires testing every two years, other states may vary.

18. It will be necessary for all FIPK's to be checked periodically for realignment, clearance and tightening of all connections. Failure to follow the above instructions or proper maintenance may void warranty.

#### ROAD TESTING:

1. Start the engine with the transmission in neutral or park, and the parking brake engaged. Listen for air leaks or odd noises. For air leaks secure hoses and connections. For odd noises, find cause and repair before proceeding. This kit will function identically to the factory system except for being louder and much more responsive.

2. Test drive the vehicle. Listen for odd noises or rattles and fix as necessary.

3. If road test is fine, you can now enjoy the added power and performance from your kit.

4. K&N suggests checking the air filter element periodically for excessive dirt build-up. When the element becomes covered in dirt (or once a year), service it according to the instructions on the Recharger service kit, part number 99-5050 or 99-5000.