

Application Scope

- Courtyard lighting.
- Small household lighting system.
- Street lighting.
- Portable solar power.
- All small power electrical devices & small PV

Electrical Characteristics

● Characteristics	35W
● Open-Circuit Voltage(Voc)	22.0V
● Optimum Circuit Voltage(Vmp)	17.5V
● Short-Circuit Current(Isc)	2.15A
● Optimum Circuit Current(Imp)	2.00A
● Maximum Power at STC(Pmax)	35W
● Module Efficiency	11.56%
● Operating Temperature	-40℃ to +85℃
● Maximum System Voltage	1000V DC
● Power tolerance	±3%
● STC: Irradiance 1000W/ m ² , Module temperature 25℃, AM=1.5	



Size

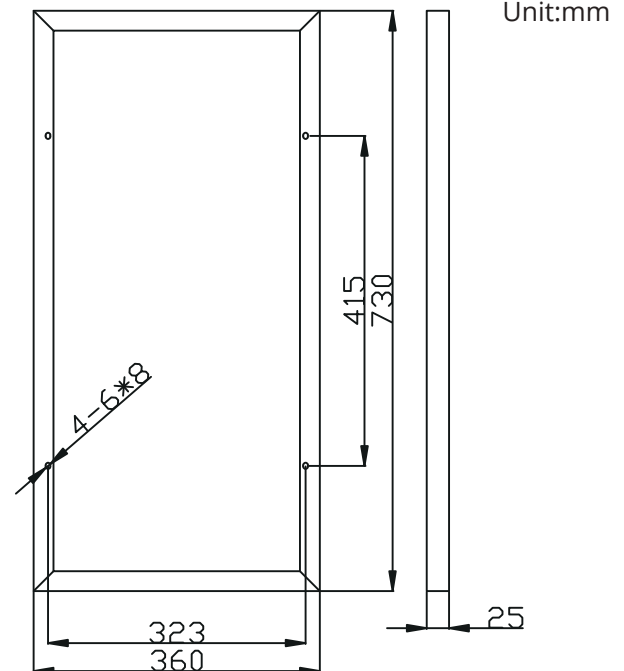

Mechanical Characteristics

● Type of cell	Poly-crystalline 125 x 125 mm (5 inches)
● Dimensions	730x360x25mm (28.7x14.2x1 inches)
● Weight	4.1Kg(9 lbs)
● Front Glass	Low-Iron Tempered Glass
● Frame	Aluminum Alloy
● Encapsulation	Glass/EVA/Cells/EVA/TPT
● Relative Humidity	0 to 100%
● Resistance	227g steel ball fall down from 1m height and 60m/s wind
● Snow load parameters	2400Pa

Temperature Coefficients

● Nominal Operating Cell Temperature(NOCT)	45℃±5℃
● Temperature Coefficient of Pmax	-0.45%/℃
● Temperature Coefficient of Voc	-0.35%/℃
● Temperature Coefficient of Isc	+0.05%/℃
● Maximum Series Fuse/current rating	10A

Power Your Green Life!

ACOPOWER Solar Panel Installation Manual

General provision

⚠ a. Installation should only be performed by qualified personnel. Each module is supplied with connectors used for system electrical connections. For the convenience of installation, ACOPOWER can provide customized cables as client required. Installers should assume all risks of injury that might occur during installation.

b. Inappropriate transport and installation may break the module and void the warranty.

Ready to work

To set up the mounting bracket of solar panel depends on its size. The bracket fixing hole must be on the basis of the pitch of hole of the solar panel module. The installation tools include: appropriate fasteners (screws, nuts) and the other installation tools.

Installation Photovoltaic Module

Grounding installation :

a. For Grounding installation, please use "Solar Panel Single Arm Universal Pole Mounting Kit" to install according to the installation instructions guide.

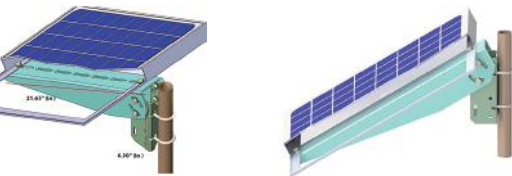

b. For simple installation, please use facile fixative bracket to set up. It is easy to adjust the angle. This installation can be set up on the floor or the wall.



c. For rooftop installation, please choose "Solar Panel Mounting Z Bracket" to install on the roof and RV, Boats and other systems

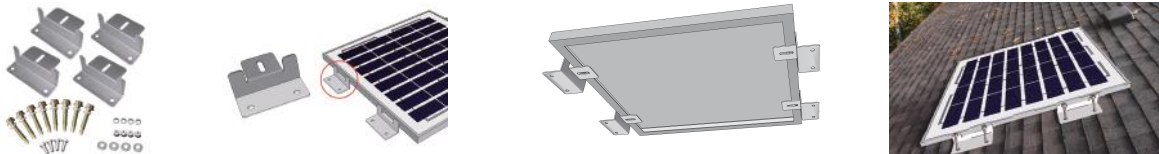

Solar panel connection

The length of the cable that connected with the solar panel junction box is 1M (39.37 INCH) , which should be noted the polarity of the output. The standard wiring polarity is "face terminal box: left" - "right" + , also the polarity can be viewed on the wiring. After installation of each solar panel, series and parallel connection must be set up based on design requirements of voltage and current. Series connection is "-" and "+", "-" and "+" operator ,increased the charging voltage, FIG:(a). Parallel connection is "-" and "-" connected, "+" and "+" increased the charging current, FIG:(b). To use a different connection, solar panel can charge battery for 12V, 24V 36V 48V through the solar charge controller

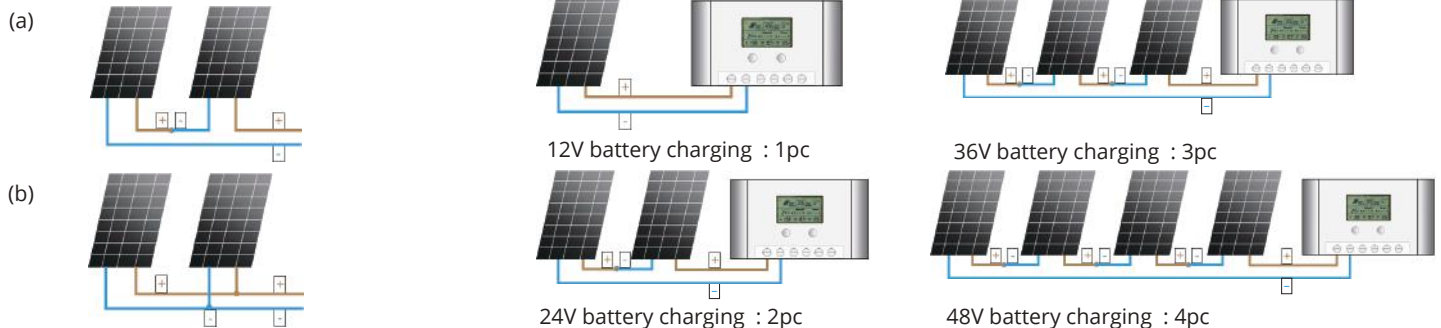

The installation angle can be adjustable according to different geographical location, mostly associated with latitude.

ACOPOWER Team has solar design experts can provide professional and free design! Email :tech@acosolar.com