



70-Pint Dehumidifier

User Guide

Thank you for purchasing the Ivation 70 Pint Dehumidifier. This User Guide is intended to provide you with guidelines to ensure that operation of this product is safe and does not pose risk to the user. Any use that does not conform to the guidelines described in this User Guide may void the limited warranty.

Please read all directions before using the product and retain this guide for reference. This product is intended for household use only.

This product is covered by a limited one-year warranty. Coverage is subject to limits and exclusions. See warranty for details.

This dehumidifier is Energy Star rated for quality assurance (www.energystar.gov).

European Disposal Instructions

When using this product in European countries, follow the instructions below:

DISPOSAL: Do not dispose this product as unsorted municipal waste. Collection of such waste separately for special treatment is necessary. Disposal of this appliance in domestic household waste is prohibited. For proper disposal, there are several possibilities:

- A) Each municipality has established collection systems, where electronic waste can be disposed of free of charge to the user.
- B) When buying a new product, the retailer will take back the old product free of charge.
- C) The manufacturer will take back the old appliance for disposal free of charge to the user.
- D) As old products contain valuable resources, they can be sold to scrap metal dealers.

Unauthorized disposal of waste in forests and other natural land endangers public health when hazardous substances leak into the ground water and infiltrate the food chain.



CAUTION!

- This appliance is not intended for use by persons (including children) with reduced physical, sensory or mental capabilities or lack of experience and knowledge, unless they have been given supervision or instruction concerning use of the appliance by a person responsible for their safety.
- Do not let children play with or operate the product. Cleaning and maintenance should not be performed by children without supervision.
- Do not operate the appliance if the power supply cord is damaged.
- This appliance must be installed in accordance with national wiring regulations.
- Operation should take place at least three feet (one meter) from combustible materials.
- Contact an authorized service technician for repair or maintenance of this unit.



Safety Precautions

To prevent injury to the user or others as well as property damage, the following instructions must be followed. Incorrect operation due to ignoring of instructions may cause harm or damage.







The seriousness is classified by the following indications:

-  **WARNING:** This symbol indicates the possibility of death or serious injury.
-  **CAUTION:** This symbol indicates the possibility of injury or damage to property.









Meanings of symbols used in this manual are as shown below.

-  Never do this.
-  Always do this.

Warning

-  **Do not exceed the power rating of the outlet or connection device.**
This may cause electric shock or fire due to excess heat generation.
-  **Do not modify power cord length or share the outlet with other appliances.**
This may cause electric shock or fire due to heat generation.
-  **Disconnect the power if strange sounds, smell, or smoke comes from it.**
This may cause electric shock or fire due to excess heat generation.
-  **Do not use the machine near flammable gas or combustibles, such as gasoline, benzene, thinner, etc.**
This may cause an explosion or fire.
-  **Do not operate or stop the unit by switching on or off the electrical power.**
This may cause electric shock or fire due to heat generation.
-  **Do not insert or pull out plug with wet hands.**
This may cause electric shock.
-  **Never try to take apart or repair the unit yourself.**
This may cause failure of machine or electric shock.
-  **Do not drink or use the water drained from the unit.**
This contains contaminants and could make you sick.
-  **Do not use a damaged or unspecified power cord.**
This may cause electric shock or fire.
-  **Do not place the unit near a heat source.**
Plastic parts may melt and cause a fire.
-  **Before cleaning, turn off the power and unplug the unit.**
This may cause electrical shock or injury.
-  **Do not remove water reservoir during operation.**
This may cause electric shock.

Caution

-  **Do not cover or obstruct the intake or exhaust openings.**
A lack of airflow can lead to overheating or fire.
-  **Always insert the filters securely. Clean filter once every two weeks.**
Operation without filters may cause failure of appliance.
-  **Do not place heavy objects on the power cord and take care so that the cord is not compressed.**
This presents a danger of fire or electric shock.
-  **Do not use in areas where chemicals are handled.**
This will cause the unit deterioration due to chemicals and solvents dissolved in the air.
-  **Do not place flower vases or other water containers on top of the unit.**
Water may spill inside the unit, causing insulation failure and electrical shock or fire.
-  **Never insert fingers or other foreign objects into grills or openings. Take special care to warn children of these dangers.**
It may cause electric shock or failure of appliance.
-  **Care should be taken when using the unit in a room with the following persons:**
Infants, children, elderly people, and people not sensitive to humidity.
-  **If water enters the unit, turn the unit off and disconnect the power. Contact a qualified service technician.**
This may cause failure of appliance or accident.
-  **Do not climb up on or sit on the unit.**
You may be injured if you fall or if the unit falls over.

Electrical Information

- The manufacture's nameplate is located on the rear panel of the unit and contains electrical and other technical data specific to this unit.
- Be sure the unit is properly grounded. To minimize shock and fire hazards, proper grounding is important.
- The power cord is equipped with a three-prong grounding plug for protection against shock hazards.
- Your unit must be used in a properly grounded wall outlet. If the wall outlet you intend to use is not adequately grounded or protected by a time delay fuse or circuit breaker, have a qualified electrician install the proper outlet.
- Ensure the outlet is accessible after the unit installation.
- **Do not use extension cords or an adapter plugs with this unit.** However, if it is necessary to use an extension cord, use an approved dehumidifier extension cord only (available at most local hardware stores).
- To avoid the possibility of personal injury, always disconnect the power supply to the unit, before installing and/or servicing.

Understanding the Control Panel

The control panel may differ slightly from the illustration below.

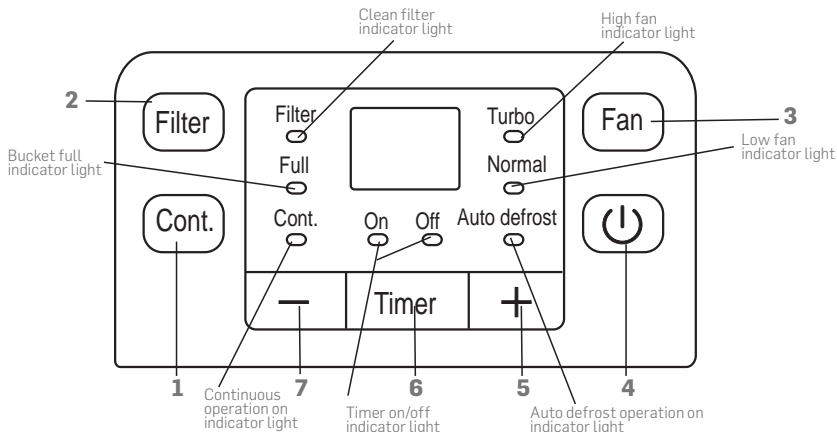

Control buttons

When the button is pushed to change operation modes, the unit will make a beeping sound to indicate that it is changing modes.

- 1 Continue Button**
Press to activate the continuous dehumidifying operation.
- 2 Filter Button**
The Check Filter feature is a reminder to clean the Air Filter for more efficient operation. The Filter light will illuminate after 250 hours of operation. To reset after cleaning the filter, press the Filter button and the light will go off.
- 3 Fan Button**
This button controls the fan speed. Press to select either High or Normal fan speed. Set the fan control to High for maximum moisture removal. When the humidity has been reduced and quieter operation is preferred, set the fan control to Normal.
- 4 Power Button**
Press to turn the dehumidifier on and off.

Humidity Set Control Buttons

5, 7 Up/Down Buttons

TIMER Set Control Buttons

Use the Up/Down buttons to set the Auto start and Auto stop time from 0.0 to 24.

The humidity level can be set within a range of 35%RH (Relative Humidity) to 85%RH (Relative Humidity) in 5% increments.

For drier air, press the \ominus button and set to a lower percent value (%).
For moister air, press the \oplus button and set a higher percent value (%).

6 Timer Button

Press to initiate the Auto start and Auto stop feature, in conjunction with the \oplus and \ominus buttons. Display: Shows the set % humidity level from 35% to 85% or auto start/stop time (0~24) while setting, then shows the actual ($\pm 5\%$ accuracy) room % humidity level in a range of RH (Relative Humidity) to 90%RH (Relative Humidity).

Error Codes and Protection Code:

- AS** Humidity sensor error: Unplug the unit and plug it in again. If error repeats, call for service.
- ES** Temperature sensor error: Unplug the unit and plug it in again. If error repeats, call for service.
- P2** Reservoir is full or reservoir is not in right position: Empty the reservoir and replace it in the right position.

Additional Features

Full Light: Glows when the reservoir is ready to be emptied, when the reservoir has been removed or has not been replaced in the proper position.

Auto Shut Off: The dehumidifier shuts off automatically after 30 seconds when the reservoir is full, or when the reservoir is removed or not replaced in the proper position. When the set humidity level is reached, the unit will also shut off automatically. For some models, the fan motor will continue operating.



Auto Defrost: When frost builds up on the evaporator coils, the compressor will cycle off and the fan will continue to run until the frost disappears.

Three (3) Minute Restart Delay: After the unit has stopped, it cannot restart within the first three (3) minutes. Operation will automatically start again after three (3) minutes.

Check Filter Feature: The system starts to count down the time once the fan motor operates. The Check Filter feature can only be activated when the total operation time reaches 250 hours or more. The Reset Light (Clean Filter indicator) flashes once per second if the filter requires cleaning. Press the Filter button and the Reset light (Clean Filter indicator light) will turn off.

Auto-Restart: If the unit shuts off unexpectedly due to a power outage, it will restart with the previous function setting automatically when the power resumes.

Setting the Timer

- When the power is on, press the Timer button. The Timer Off indicator light will illuminate. This indicates that the Auto Stop function is initiated. Press it again and the Timer On indicator light will illuminate. This indicates that Auto Start is initiated.
- When the power is off, press the Timer button. The Timer On indicator light will illuminate. This indicates that the Auto Start function is initiated. Press it again and the Timer Off indicator light will illuminate. This indicates that Auto Stop is initiated.
- Press or hold the UP  or DOWN  buttons to change the Auto time by 0.5 hour increments up to ten (10) hours, and at one (1) hour increments up to 24 hours. The control will count down the remaining time until start.
- The selected time will register in five (5) seconds and the system will automatically revert to display the previous humidity setting.
- When the Auto Start and Auto Stop times are set within the same program sequence, the Timer On/Off indicator lights illuminate together identifying both On and Off times are now programmed.
- Turning the unit On or Off at any time or adjusting the timer setting to 0.0 will cancel the Auto Start/Stop function.
- When LED display window displays the code P2, the Auto Start/Stop function will also be canceled.

Identification of Parts

The unit appearance may differ slightly from the illustration below.

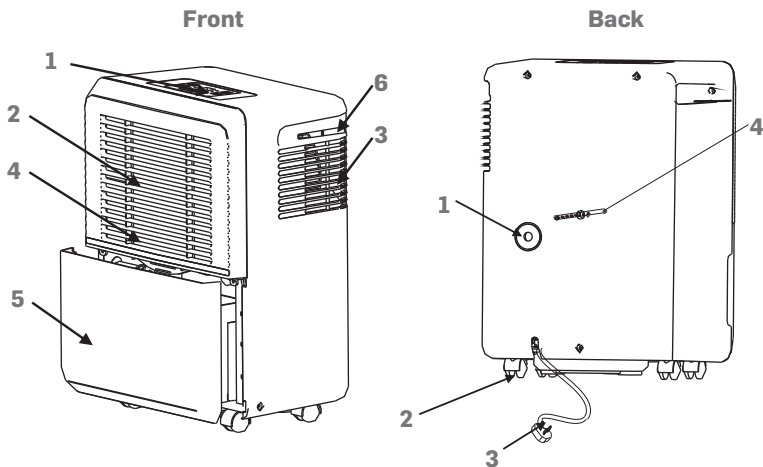

Front

1. Control Panel
2. Air Intake Vent
3. Air Outlet Vent
4. Air Filter (behind vent)
5. Water Reservoir
6. Handle (on both sides)

Back

1. Drain Hose Outlet
2. Caster
3. Power Cord and Plug
4. Band (for storing unit)

Drain Hose (1 pc.)

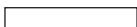

Adaptor (1 pc.)

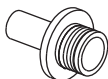

Screw (2 Pcs.)



Positioning the Unit

A dehumidifier operating in a basement will have little or no effect in drying an adjacent enclosed storage area, such as a closet, unless there is adequate circulation of air in and out of the area.

- Do not use outdoors.
- This dehumidifier is intended for indoor residential applications only. This unit should not be used for commercial or industrial applications.
- Place the dehumidifier on a smooth, level floor strong enough to support the unit with a full reservoir of water.
- Allow at least 8" (20cm) of air space on all sides of the unit for good air circulation.
- Place the unit in an area where the temperature will not fall below 41°F (5°C). The coils can become covered with frost at temperatures below 41°F (5°C), which may reduce performance.
- Place the unit away from a clothes dryer, heater or radiator.
- Use the unit to prevent moisture damage anywhere books or valuables are stored.
- Use the dehumidifier in a basement to help prevent moisture damage.
- The dehumidifier must be operated in an enclosed area to be most effective.
- Close all doors, windows and other outside entrances or openings in the room.

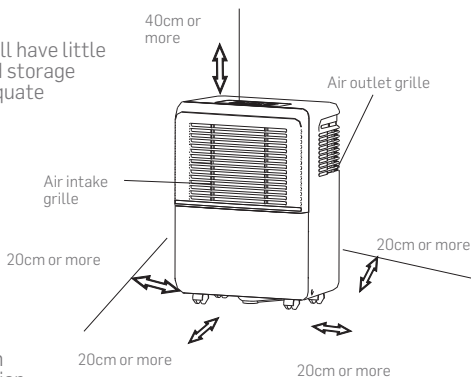

Casters

- Casters move freely.
- Do not force casters to move over carpet, or move the unit with water in the reservoir. (The unit may tip over and spill water.)

General Operation

- When first using the dehumidifier, operate continuously for 24 hours.
- This unit is designed to operate with a working environment between 41°F (5°C) and 95°F (35°C).
- If the unit has been switched off and needs to be switched on again quickly, allow approximately three (3) minutes for operation to resume.
- Do not connect the dehumidifier to a multiple socket outlet that is also being used for other electrical appliances.
- Select a suitable location. Make sure you have easy access to an electrical outlet.
- Plug the unit into an electrical socket-outlet with earth (grounded) connection.
- Make sure the water reservoir is correctly fitted otherwise the unit will not operate properly.
- Do not move the unit when the water reservoir is full or nearly full. The unit may tip over.

Removing Collected Water

There are two ways to remove collected water.

1. Using the reservoir

- When the unit is Off, if the reservoir is full, the unit will beep eight (8) times, the Full indicator light will flash, and the digital display will show P2.
- When the unit is On, if the reservoir is full, the compressor turns off and the fan turns off after 30 seconds to dry the water in the condenser. Then the unit will beep eight (8) times, the Full indicator light will flash, the digital display shows P2.
- Slowly remove the reservoir. Grip the left and right handles securely, and carefully slide out straight so water does not spill. Do not rest it on the floor because the bottom of the reservoir is uneven. It will fall and cause the water to spill.
- Discard water and replace the reservoir. The reservoir must be in place securely for the dehumidifier to operate.
- The machine will re-start when the reservoir is restored in its correct position.

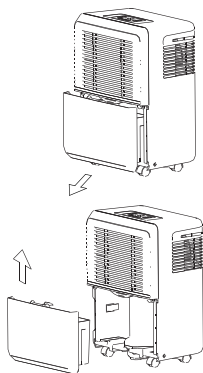

NOTES:

- When you remove the reservoir, do not touch any parts inside of the unit. Doing so may damage the product.
- Be sure to slide the reservoir gently all the way into the unit. Banging the reservoir against anything or failing to secure it may cause the unit not to operate.
- When the reservoir is removed, if water remains in the unit, it must be dried.

2. Continuous draining

- Water can be automatically emptied into a floor drain by attaching the unit with a water hose (1/2" ID, not included) with a female threaded end (ID:M=1, not included).
- Install the drain hose onto the adaptor (See illustration).
- Remove the plastic cover from the back drain outlet of the unit and set aside, remove reservoir, then insert the drain hose through the drain outlet of the unit and securely press it into the connector on the front of the unit. (See illustration)
- Tighten the adaptor and the unit by using two screws (placed in the reservoir).
- Install the female threaded end of the water hose into the adaptor (See illustration), then lead the water hose to the floor drain or a suitable drainage facility.
- Make sure the hose is secure so there are no leaks.
- Direct the hose toward drain, making sure that there are no kinks to stop water flow.
- Place the end of the hose into the drain and make sure the end of the hose is level or positioned in a downward direction to let the water flow smoothly. Do not raise the hose above the floor.
- Place the reservoir back in the unit and make sure that it is correctly secured.
- Select the desired humidity setting and fan speed on the unit for continuous draining to start.

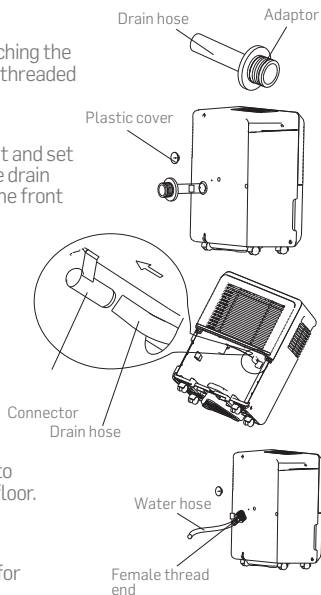

NOTE: When the continuous drain feature is not being used, remove the drain hose from outlet.

Care and Cleaning

Turn the dehumidifier off and remove the plug from the wall outlet before cleaning.

1. Clean the vent and case

- Use water and a mild detergent. Do not use bleach or abrasives.
- Do not splash water directly onto the main unit. Doing so may cause an electric shock, cause the insulation to deteriorate, or cause the unit to rust.
- The air intake and outlet vents get soiled easily, so use a vacuum attachment or brush to clean.

2. Clean the reservoir

- Every few weeks, clean the reservoir to prevent growth of mold, mildew and bacteria. Partially fill the reservoir with clean water and add a little mild detergent. Swish it around in the reservoir, empty and rinse.

NOTE: Do not clean the reservoir in a dishwasher.

3. Clean the air filter

- Remove the filter every two weeks based on normal operating conditions.
- Remove the filter from the top of the unit (See illustration), or remove the reservoir and then pull filter downward (See illustration).
- Wash the filter with clean water and let air dry.
- Re-install the filter and replace reservoir.

CAUTION: DO NOT operate the dehumidifier without a filter because dirt and lint will clog it, reducing performance.

4. When Not Using Unit for Long Periods of Time

- After turning off the unit, wait one day before emptying the reservoir so that any moisture trapped in the unit will drip into the reservoir.
- Clean the main unit, water reservoir and air filter.
- Wrap the cord and bundle it with the band (See illustration).
- Cover the unit with a plastic bag.
- Store the unit upright in a dry, well-ventilated place.

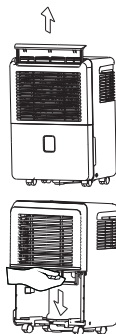

Troubleshooting Guide

Unit does not start

- Make sure the dehumidifier's plug is secured entirely into the outlet.
- Check your home fuse/circuit breaker box.
- Dehumidifier has reached its preset level or reservoir is full.
- Water reservoir is not in the proper position.

Dehumidifier does not dry the air as it should

- Allow enough time to remove the moisture.
- Make sure there are no curtains, blinds or furniture blocking the front or back of the dehumidifier.
- The humidity control may not be set low enough.
- Check that all doors, windows and other openings are securely closed.
- Room temperature is too low, below 41°F (5°C).
- There is a kerosene heater or something giving off water vapor in the room.

The unit makes a loud noise when operating

- The air filter is clogged.
- The unit is tilted instead of upright as it should be.
- The floor surface is not level.

Frost appears on the Coils

- This is normal. The dehumidifier has an Auto defrost feature.

Water on floor

- Hose or connection may be loose.
- The reservoir is being used to collect water, but the rear drain plug is removed.

ES, AS, P2 and EC appear in the display

- These are error codes and protection code. See the CONTROL BUTTONS ON THE DEHUMIDIFIER section.

This product is covered by a limited one-year warranty. Coverage is subject to limits and exclusions. See warranty for details.

Customer Service:

info@myivation.com

866-849-3049

Distributed by
C&A Marketing, Inc.
114 Tived Lane East
Edison, NJ 08837 USA

Europe: C&A Europe
167 Hermitage Road
Crusader Industrial Estate
London N4 1LZ
United Kingdom

info@myivaton.com

Made in China
Ivation is a trademark of C&A IP
Holdings, LLC
©2016 All rights reserved