

INSTRUCTION MANUAL

Remote Meter: MT50



Thank you very much for selecting our product!

This manual offers important information and suggestions with respect to installation, use and troubleshooting, etc. Please read this manual carefully before using the product.

Remote Meter

MT50

Remote meter (Model MT50) is available to connect with solar controller LSxxxxB(P), VSxxxxBN and TracerxxxxBN(P).

Contents

1 Important Safety Instructions	1
2 General Information	2
2.1 Features	2
2.2 Main functions	3
2.3 Recommendations.....	3
3 Installation.....	4
4 Product Features	8
5 Operation.....	12
5.1 Buttons	12
5.2 Main menu	13
5.3 Real-time monitoring	14
5.4 Device information	16
5.5 Test operation.....	16
5.6 Control parameter.....	17
5.7 Load setting	21
5.8 Device parameter	24
5.9 Device password.....	25
5.10 Factory reset	25
5.11 Failure information	26
5.12 Meter parameter	27
6 Technical Specifications	28

1 Important Safety Instructions

SAVE THESE INSTRUCTIONS:

This manual contains important safety, installation and operating instructions for the Remote Meter.

General safety information

- Please inspect the MT50 thoroughly after it is delivered. If any damage is seen, please notify the shipping company or our company immediately. A photo of the damage may be helpful.
- Read all instructions and cautions in the manual before starting the installation.
- Keep the MT50 away from rain, exposure, severe dust, vibrations, corrosive gas and intense electromagnetic interference.
- Do not allow water to enter remote meter.
- There are no user serviceable parts inside the controller. Do not disassemble or attempt to repair it.

2 General Information

2.1 Features

The new-generation remote display unit MT50 for LSxxxxB(P), VSxxxxBN and TracerxxxxBN(P) controllers is an associated display device which supports both the latest communication protocol and the voltage technology standard of solar controllers. The products have many excellent functions:

- Automatic identify and display the type, model and relevant parameter data of controllers;
- Real-time display the operational data and working status of the connection devices in digital, graphic and textual forms by a large-screen multifunction LCD;
- Direct, convenient and rapid operation of six navigation function keys;
- Both data and power flowing on the same lead, no need for external power;
- Real-time data monitoring and remote load switchover of the controllers, and data browse and modification of device parameters, charge control parameters and load control parameters;
- Real-time display and acoustic alarm of failure information of the connection devices;
- Longer communication distance based on RS485.

2.2 Main functions

Functions like the real-time monitoring of the operational data and working status of a controller, the browse and modification of charge/discharge control parameters, the setting of device parameters and load control parameters and the restoration of factory defaults, based on LCD display and functional key operation.

2.3 Recommendations

- Please confirm that MT50 is only allowed to connect with our LSxxxxB(P), VSxxxxBN and TracerxxxxBN(P) series controllers before purchase;
- Please do not install MT50 in a situation with strong electromagnetic interference.

3 Installation

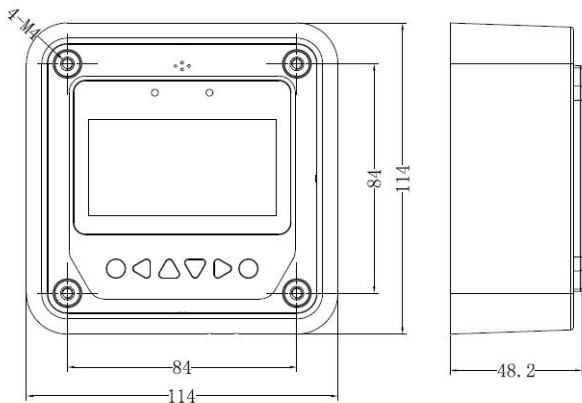

Frame Mount Dimensions(mm)

Mechanical parameter	Parameter
Overall dimension	114 x 114 x 32.7mm 4.49 x 4.49 x 1.29inches
Mounting dimension	88.6x 88.6mm 3.49 x 3.49inches
Terminal	Φ4.3

Wall installation steps:

Step1: Locate and drill screw holes based on the Frame Mounting dimension of the base, and erect the plastic expansion bolts;

Step 2: Use four ST4.2x32 self-tapping screws to fix the Frame;

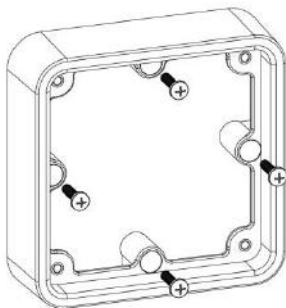

Frame Mounting

Step 3: Use four M4x8 pan head screws to mount MT50 Surface on the Frame;

Step 4: Mount the four associated screw plugs into the screw holes.

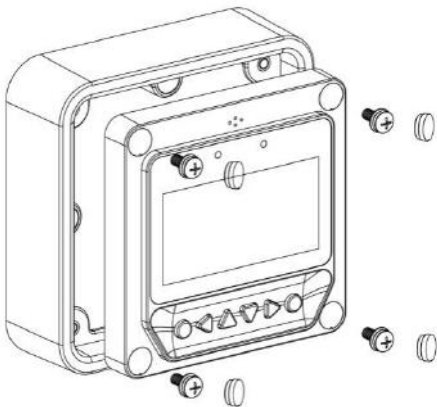

Surface Mounting

Steps of surface mounting:

Step 1: Locate and drill screw holes based on the installation size of the Surface;

Step 2: Use four M4x8 cross recessed pan head screws with M4 nuts to mount MT50 Surface onto the panel;

Step 3: Mount the four associated white screw plugs into the screw holes.

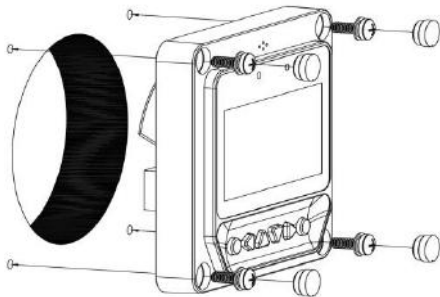

Surface mounting

Notice: Take full consideration of the plugging/unplugging space of the communication cable and the length of the cable during installation to see if they are appropriate.

4 Product Features

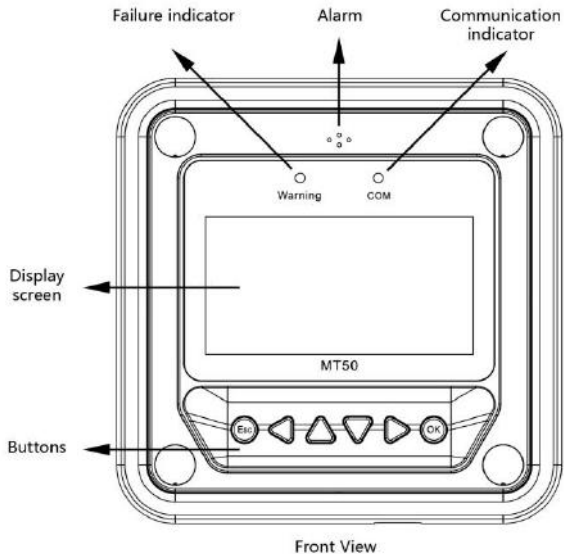

RS485 communication and power interface

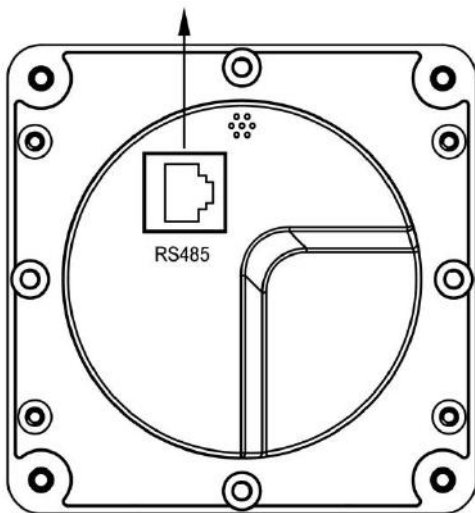

Rear View

Failure indicator

Failure indicator flashes in case of failure of the connection devices. For failure information please check the Controller Manual.

Alarm

Fault audible alarm, could be activated or deactivated.

Communication indicator

Indicate communication status when MT50 is connected with the controller.

Display screen

Man-machine interaction operation interface.

Buttons

The Meter buttons includes four navigation buttons and two operational buttons. See the specific directions in the Operational Manual.

RJ45 communication and power interfaces

Communication and power supply cable interfaces, used for communication connection with controllers.

Note: Please use the communication plug which is marked with “MT” to connect MT50

Monitoring screen

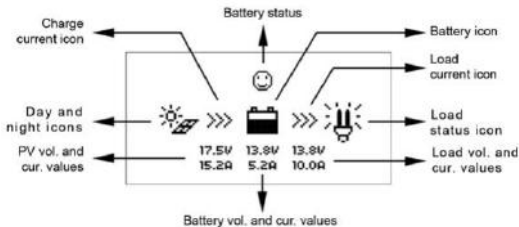

Day and night icons

☾-Night, ☀️- Day: The threshold voltage is 1V. Higher than 1V is daytime.

Charge current icon

The icon is dynamically if there is charge current.

Battery icon

The battery capacity is dynamically displayed

Note: When the battery is in over discharge status, the icon displayed is“  ”.

Battery status icons

😊-Normal voltage, 😐-Under voltage, 😞-Over discharge.

Load current icon

The icon is dynamically if there is discharge current.

Load status icon

💡- Load On, ⏻- Load Off.

5 Operation



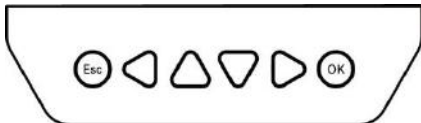

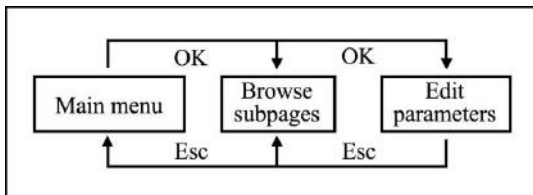

5.1 Buttons



The buttons are respectively (from left to right) "ESC", "Left", "Up", "Down", "Right" and "OK" buttons, the operation is described in the schematic operation diagram below:



Schematic operation diagram

The default entry page is the browse mode. Pressing  button and inputting the correct password to enter the modification mode;  and  buttons could be used to move the cursor,  and  buttons could be used to modify the parameter values when the cursor is located at the current place;  and  buttons could be finally used to respectively confirm and cancel the modification of the control parameters.

5.2 Main menu

“Up” and “Down” buttons are respectively used to move the cursor to select the menu items, “OK” and “ESC” buttons are respectively used to enter or exit the corresponding pages of the menu items.





1. Monitoring
2. Device Info.
3. Test Operation
4. Control Para.

5. Load Set
6. Device Para
7. Device PSW.
8. Factory Reset

9. Failure Info.
10. Meter Para.

5.3 Real-time monitoring

There are 14 pages under real-time monitoring. Please check it as below:

		
		
17.5V	13.8V	13.8V
15.2A	5.2A	10.0A

LS101240EPLI
Jan-01-2013
02:34:33

Char. Energy	
Day:	0.00kwh
Mon:	0.00kwh
Total:	0.00kwh





DisCh. Energy	
Day:	0.00kwh
Mon:	0.00kwh
Total:	0.00kwh

Battery	
Vol:	0.0V
Cur:	0.0A

Battery	
Temp.:	22.4°C
Max. Vol:	12.7V
Min. Vol:	12.7V

Battery	
Charge:	NoCharge
Enege:	Normal
Fault:	No

<p style="text-align: center;">PV</p> <p>Vol: 0.0V</p> <p>Cur: 0.0A</p> <p>Power: 0.0W</p>	<p style="text-align: center;">PV</p> <p>Sta.: Disconnect</p> <p>Fault: No</p> <p>Char.: DCC</p>
<p style="text-align: center;">Controller</p> <p>Temp.: 25.0°C</p> <p>Sta.: Normal</p>	
<p style="text-align: center;">Load</p> <p>Vol: 0.0v</p> <p>Cur: 0.0A</p> <p>Power: 0.0W</p>	<p style="text-align: center;">Load</p> <p>Sta.: OFF</p> <p>Fault: No</p>
<p style="text-align: center;">Load Mode Information</p>	<p style="text-align: center;">Load Mode Information</p>



Operational tips:  and  buttons are respectively used to turn the browse page upward and downward, while  and  buttons are respectively used to turn the interfaces left and right.

5.4 Device information

The product model, parameters and SN code of the controllers are displayed below:

LS101240EPLI	
Rate.Vol:	12V
Char.Cur:	10.0A
Disc.Cur:	2.6A





LS101240EPLI
SN:0002201301200045

Operational tips:  and  buttons are respectively used to turn the browse page upward and downward.

5.5 Test operation

Load switch test operation is conducted on the connection solar controller to see if the load output is normal. The test operation does not affect the working settings under actual load, which means that the solar controller will exit from the test mode when exiting the operational interface of the test.

Test Operation
LS101240EPLI: OFF

Operational tips: Enter the page and input correct password; use  and  buttons to modify the On/Off status values, while use  and  buttons respectively to confirm and cancel the test operation.

5.6 Control parameter

Browse and modification operations are conducted over the control parameters of solar charge controller. See the scope of parameter modification in control parameters table, and the page of control parameters in the diagram below:

1	Batt. Type Sealed Batt. AH 200AH	2	Temp Comp.Coeff -3mv/°C/2V Rated Voltage 12V	3	Over Volt. Disc 16.0V Charge Limit 15.0V
4	Ooer Volt. Rec. 15.0V Eugal. Charge 14.6V	5	Boost Charge 14.4V Float Charge 13.8V	6	Boost Rec. 13.2V Low Volt. Rect. 12.6V
7	Under Volt. Rect 12.2V Under Volt. Warn 12.0V	8	Low Volt. Disc 11.1V Discharge Limit 10.6V	9	Equalize Time 120min Boost Time 120min

Control parameters table

Parameters	Default	Range
Battery type	Sealed	Sealed/Gel/Flooded/User
Battery Ah	200Ah	1~9999Ah
Temperature compensation coefficient	-3mv/°C/2V	0~-9mv
Rated voltage	Auto	Auto/12V/24V/36V/48V

Battery voltage parameters

(Parameters is in 12V system at 25°C , please use X 2 in 24V, X 3 in 36 V, and X 4 in 48 V system)

Battery charging setting	Sealed	Gel	Flooded	User
Over voltage disconnect voltage	16.0V	16.0V	16.0V	9~17V
Charging limit voltage	15.0V	15.0V	15.0V	9~17V
Over voltage reconnect voltage	15.0V	15.0V	15.0V	9~17V
Equalize charging voltage	14.6V	—	14.8V	9~17V
Boost charging voltage	14.4V	14.2V	14.6V	9~17V
Float charging voltage	13.8V	13.8V	13.8V	9~17V
Boost reconnect charging voltage	13.2V	13.2V	13.2V	9~17V
Low voltage reconnect voltage	12.6V	12.6V	12.6V	9~17V
Under voltage warning reconnect voltage	12.2V	12.2V	12.2V	9~17V
Under voltage warning voltage	12.0V	12.0V	12.0V	9~17V
Low voltage disconnect voltage	11.1V	11.1V	11.1V	9~17V
Discharging limit voltage	10.6V	10.6V	10.6V	9~17V
Equalize duration	180min	—	180min	0~180min
Boost duration	180min	180min	180min	10~180min.

Note: Battery voltage setting please in strict accordance with:

1. Over Voltage Disconnect Voltage > Charging Limit Voltage ≥ Equalize Charging Voltage ≥ Boost Charging Voltage ≥ Float Charging Voltage > Boost Reconnect Charging Voltage;
2. Over Voltage Disconnect Voltage > Over Voltage Reconnect Voltage ;
3. Low Voltage Reconnect Voltage > Low Voltage Disconnect Voltage ≥ Discharging Limit Voltage;
4. Under Voltage Warning Reconnect Voltage > Under Voltage Warning Voltage ≥ Discharging Limit Voltage;
5. Boost Reconnect Charging Voltage > Low Voltage Disconnect Voltage

5.7 Load setting

The page of load setting could be used to set the four load working modes of the connection solar controller (Manual, Light on/off, Light on+timer, Time control)

<input checked="" type="checkbox"/> Manual Control <input type="checkbox"/> Light On/off <input type="checkbox"/> Light On+Timer <input type="checkbox"/> Time Control	Manual Control Default : ON	
<input type="checkbox"/> Manual Control <input checked="" type="checkbox"/> Light On/off <input type="checkbox"/> Light On+Timer <input type="checkbox"/> Time Control	Light On/Off On 05.0V DeT 10M Off 06.0V DeT 10M	
<input type="checkbox"/> Manual Control <input type="checkbox"/> Light On/off <input checked="" type="checkbox"/> Light On+Timer <input type="checkbox"/> Time Control	Light On+Timer On 05.0V DeT 10M Off 06.0V DeT 10M NightTime10H:00M	Light On+Timer OnTime1 01H:00M OnTime2 01H:00M
<input type="checkbox"/> Manual Control <input type="checkbox"/> Light On/off <input type="checkbox"/> Light On+Timer <input checked="" type="checkbox"/> Time Control	Time Control <input checked="" type="checkbox"/> Time1 OnTime 10:00:00 OffTime 19:00:00	Time Control <input type="checkbox"/> Time2 OnTime 19:00:00 OffTime 19:00:00

① Manual control

Mode	Introductions
On	Load is on all the time if battery capacity is enough and no abnormal conditions happen.
Off	Load is Off all the time.

② Light On/Off

Light On voltage(Night threshold)	When input voltage of solar module is lower than Light On voltage, it automatically turns on load output if battery capacity is enough and no abnormal conditions happen.
Light Off voltage(Day threshold)	When input voltage of solar module is higher than Light Off voltage, it automatically turns off load output.
Delay time	The confirmation time for Light signal. During the period, if light signal voltage continues matching Light On/Off voltage, it will carry out corresponding actions(The time adjustment range:0~99mins).

③ Light On+ timer

Working time 1 (T1)	Load working period after light control turns on load	Any of the working time is set as "0", it means this time will stop working. The real working time of T2 depends on the Night time, and the length of T1, T2.
Working time 2 (T2)	Load working period before light control turns off load	
Night time	Total night time controller get from calculation ($\geq 3h$)	

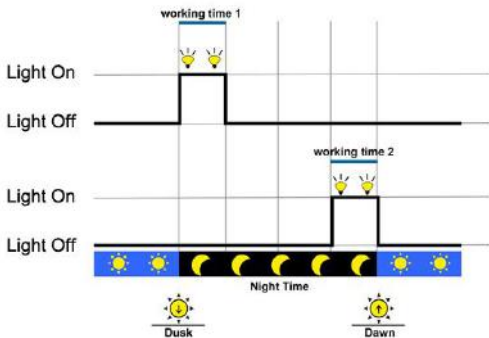

④Time control

Working time1 (T1)	Control on/off time of load through real-time clock mode.	Working time 1 is the compulsory load working time interval. Working time 2 is an optional.
Working time2 (T2)	Realize the dual timer function of the load control through real-time clock mode.	

5.8 Device parameter

The software version information of solar charge controller could be checked via the page of device parameters, and device data like device ID, device LCD backlight time and device clock could be checked and modified. The page of device parameter in the diagram below:

Device Parameter Ver: V01.00+V02.10 ID: 001	Device Parameter Bklight:60S Jan-01-2013 00:01:39
---	--

Note: the bigger the ID value of the connection device, the longer the Meter communication identification interval (the maximum interval<6 minutes).

Type	Notes
Ver	Solar charger controller software and hardware version numbers.
ID	Solar charger controller communication ID numbers.
Bklight	Solar charger controller LCD backlight working time.
Month-Day-Year H:M:S	Solar charger controller internal clock.

5.9 Device password

The password of the solar charge controller could be modified via the page of device password; the device password is a 6-digit figure which is required before entering the modification mode of “Control parameter”, “Load setting”, “Device parameter”, “Device password”, “Factory reset” pages. The page of device password in the diagram below:

Device PSW OriPsw:xxxxxx NewPsw:xxxxxx
--

Note: Solar charge controller default password is”000000”

5.10 Factory reset

The default parameter values of solar charge controller could be restored via the Factory reset page, which means the “Control parameter”, “Load setting”, “Charge mode” and “Device password” of the devices could be restored to the factory defaults (the factory default password of the devices is “000000”).

Factory Reset Yes No

5.11 Failure information

The current failure information of the solar charge controller could be checked via the Failure information page (a maximum of 15 failure messages could be displayed); when the failures of solar charge controller are eliminated, the corresponding failure information will also be automatically eliminated.

Failure Info
1.Over voltage
2.Over load
3.Short circuit

Failure information	Details
Load MOS-Short	The MOSFET of load driver is short.
Load Circuit	The load circuit is short.
Load O. cur.	The load circuit is over current.
Input O. cur.	PV input current is over rate.
RPP Short	The MOSFET of reverse polarity protection is short.
RPP Break	The MOSFET of reverse polarity protection is break.
Char.MOS-Short	The MOSFET of charge driver is short.
Input O. Cur.	Input current is over rate.
Disc.O.O.Ctrl.	Discharge operation is out of control.
Ctrlr O.Temp.	The controller is over temperature.
Comm. Timeout	The communication is timeout.

5.12 Meter parameter

The meter model, software and hardware version, and SN NO. could be checked via Meter parameter page. And the three parameters (Switch pages, Backlight, Audible alarm) could be browsed and modified as well.

Meter Para. Taye: MT50 Ver: V1.00+V1.00 SN:
--

Meter Para. Sw-Pages:000S Bklight:020S AudiAlam: OFF

Note: When the set up is accomplished, the auto switch page cannot become effective until ten minutes later.

Parameters	Default	Range	Remark
Sw-Pages	0	0~120S	The automatic switchover inverter for real-time <u>monitoring page</u>
BKlight	20	0~999S	LCD backlight time
AudiAlam	OFF	ON/OFF	Turn ON /OFF the acoustic alarm function in case of failure on solar charge controller

6 Technical Specifications

Electrical Parameter

Self-consumption	Backlight and acoustic alarm ON<65mA
	Backlight ON<23mA
	Backlight OFF<15mA

Mechanical Parameter

Faceplate dimensions	98x98 mm
Frame dimensions	114x114 mm
Connector type	RJ45
Meter cable	Standard 2m,Max 50 m
Meter weight	Simple package: 0.23 Kg Standard package:0.32 Kg

Environmental Parameter

Ambient temperature	-20℃~+70℃
---------------------	-----------

Definitions of interface pins

Pin No.	Definition
1	Power+5~12V input
2	Power+5~12V input
3	RS485-B
4	RS485-B
5	RS485-A
6	RS485-A
7	GND
8	GND

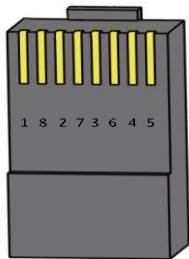

Data cable pin definitions

REMOTE METER DIMENSIONS (mm)

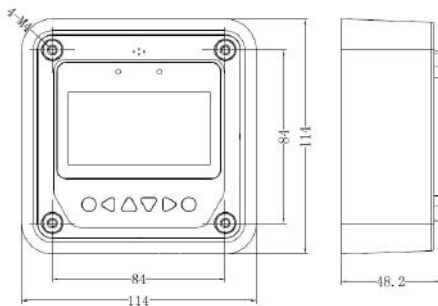
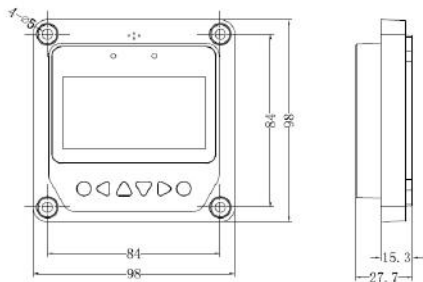

Any changes without prior notice! Version number: V2.0



USA Sales: 4120 Valley Blvd, Ste B, Walnut, CA 91789, USA

Tel: +1-626-575 8822/7722 Fax: +1-626-800 2255

Web: www.ACOPowe.com

Email: sales@acopower.com