

## Stereo Turntable System

### Operating Instructions

---

Getting Started

---

Listening to a Vinyl Record

---

Recording a Vinyl Record

---

Maintenance

---

Additional Information

## Owner's Record

The model number and serial numbers are located at the rear. Record these numbers in the spaces provided below. Refer to these numbers whenever you call upon your Sony dealer regarding this product.

Model No. PS-HX500

Serial No. \_\_\_\_\_

## WARNING

To reduce the risk of fire or electric shock, do not expose this apparatus to rain or moisture.

The AC adaptor is for use in dry, indoor locations.

To reduce the risk of fire, do not cover the ventilation opening of the appliance with newspapers, tablecloths, curtains, etc. Do not expose the appliance to naked flame sources (for example, lighted candles).

To reduce the risk of fire or electric shock, do not expose this appliance to dripping or splashing, and do not place objects filled with liquids, such as vases, on the appliance.

Do not install the appliance in a confined space, such as a bookcase or built-in cabinet.

The AC adaptor must not be covered over by anything and should only be used in an ambient temperature of up to 40 °C (104 °F).

The unit is not disconnected from the mains as long as it is connected to the AC outlet, even if the unit itself has been turned off.

As the main plug of AC power adaptor is used to disconnect the AC power adaptor from the mains, connect it to an easily accessible AC outlet.

Should you notice an abnormality in it, disconnect it from the AC outlet immediately.

The AC adaptor is not available for repair and its use should be terminated immediately when the AC adaptor is found damaged or defective.

CAUTION : RISK OF ELECTRIC SHOCK  
DRY LOCATION USE ONLY

### Polarity of DC output of the AC adaptor



### Notice for the customers in the U.S.A.

#### NOTE:

This equipment has been tested and found to comply with the limits for a Class B digital device, pursuant to Part 15 of the FCC Rules. These limits are designed to provide reasonable protection against harmful interference in a residential installation. This equipment generates, uses and can radiate radio frequency energy and, if not installed and used in accordance with the instructions, may cause harmful interference to radio communications. However, there is no guarantee that interference will not occur in a particular installation. If this equipment does cause harmful interference to radio or television reception, which can be determined by turning the equipment off and on, the user is encouraged to try to correct the interference by one or more of the following measures:

- Reorient or relocate the receiving antenna.
- Increase the separation between the equipment and receiver.
- Connect the equipment into an outlet on a circuit different from that to which the receiver is connected.
- Consult the dealer or an experienced radio/TV technician for help.

### CAUTION

You are cautioned that any changes or modifications not expressly approved in this manual could void your authority to operate this equipment.

If you have any questions about this product, you may call:

Sony Customer Information Services Center  
1-800-222-7669

or <http://www.sony.com/>

#### Declaration of Conformity

Trade Name : SONY

Model Name : PS-HX500

Responsible Party : Sony Electronics Inc.

Address : 16535 Via Esprillo, San Diego, CA  
92127 USA

Telephone No. : 858-942-2230

This device complies with Part 15 of the FCC Rules. Operation is subject to the following two conditions. (1) This device may not cause harmful interference, and (2) this device must accept any interference received, including interference that may cause undesired operation.

Properly shielded and grounded cables and connectors must be used for connection to host computers and/or peripherals in order to meet FCC emission limits.

#### **Notice for customers: the following information is only applicable to equipment sold in countries applying EU directives.**

This product has been manufactured by or on behalf of Sony Corporation, 1-7-1 Konan Minato-ku Tokyo, 108-0075 Japan. Inquiries related to product compliance based on European Union legislation shall be addressed to the authorized representative, Sony Belgium, bijkantoor van Sony Europe Limited, Da Vincilaan 7-D1, 1935 Zaventem, Belgium. For any service or guarantee matters, please refer to the addresses provided in the separate service or guarantee documents.

#### **For the customers in Europe**



**Disposal of Old Electrical & Electronic Equipment (Applicable in the European Union and other European countries with separate collection systems)**

This symbol on the product or on its packaging indicates that this product shall not be treated as household waste. Instead it shall be handed over to the applicable collection point for the recycling of electrical and electronic equipment. By ensuring this product is disposed of correctly, you will help prevent potential negative consequences for

the environment and human health, which could otherwise be caused by inappropriate waste handling of this product. The recycling of materials will help to conserve natural resources. For more detailed information about recycling of this product, please contact your local Civic Office, your household waste disposal service or the shop where you purchased the product.

The validity of the CE marking is restricted to only those countries where it is legally enforced, mainly in the countries EEA (European Economic Area).

This equipment has been tested and found to comply with the limits set out in the EMC regulation using a connection cable shorter than 3 meters (10 feet).

## Features

PS-HX500 is a stereo turntable system designed for analog playback of vinyl records. By connecting a computer to the turntable, you can use the recording application exclusively designed for this turntable product to record audio tracks of the vinyl record as high resolution audio sources.

You can play recorded high resolution audio sources either by transferring the recorded high resolution audio sources to a compatible audio device or by using computer software that supports high resolution audio playback.

### Using your turntable for the first time

You first need to assemble your turntable. Thoroughly read the instructions in this manual and assemble the turntable. (See page 9.)

### Listening to a vinyl record

Your turntable does not have a built-in speaker. To listen to a vinyl record, you need to connect an audio device, such as a stereo system or an amplifier, to the turntable with the supplied PHONO cables and play the vinyl record. (See page 14.)

### Recording audio tracks onto a computer

You need to connect a computer to your turntable via the USB port and install the Hi-Res Audio Recorder application to the computer. (See page 18.)

#### Note

Your turntable is not an analog record player designed for DJ (Disk Jockey) use. Stopping or reversing the rotation of the vinyl record by hand will cause malfunctions.

## About Manuals



### Operating Instructions (this manual)

Describes basic operations of your turntable, including assembling the turntable, playing and recording a vinyl record, as well as maintenance of the system, obtaining consumable components, and troubleshooting.



### Hi-Res Audio Recorder Help (online manual)

Describes operations of the Hi-Res Audio Recorder application for recording audio tracks of a vinyl record onto a computer. To view the Help, visit <http://rd1.sony.net/help/ha/hrar/>.



#### Note

To use the Hi-Res Audio Recorder application, you need to connect to the Internet and download and install the application onto a computer.

# Table of Contents

Owner's Record .....	2
Features .....	4
About Manuals .....	4
Parts and Controls .....	6

---

## Getting Started

Unpacking.....	8
Assembling the Turntable.....	9
Attaching the Dust Cover.....	13

---

## Listening to a Vinyl Record

Connecting an Audio Device.....	14
Playing a Vinyl Record.....	15

---

## Recording a Vinyl Record

Recording Audio Tracks onto a Computer.....	18
--	----

---

## Maintenance

Cleaning the Stylus.....	20
Replacing the Stylus.....	20
Replacing the Drive Belt.....	21
Cleaning the Dust Cover and the Turntable Body .....	21

---

## Additional Information

Precautions.....	22
Troubleshooting .....	22
Repair Services .....	24
Specifications .....	25
Customer Support Websites .....	26
Index .....	26

# Parts and Controls

## Front

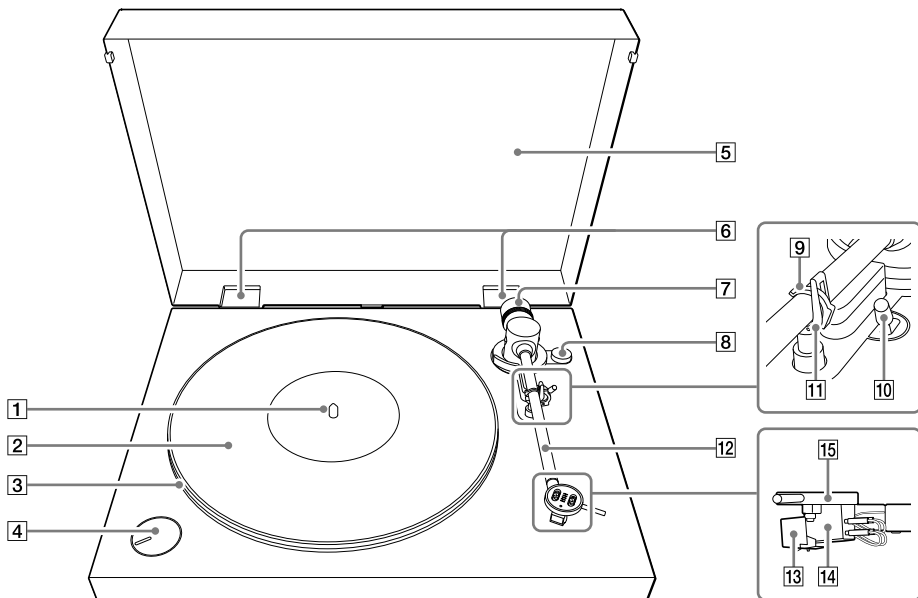

**1** Spindle (page 9)

**2** Rubber mat (page 8, 10)

**3** Platter (page 8, 9)

Place the platter on the spindle while you are assembling your turntable. It has a drive belt wound around on the back side.

**4** SPEED/POWER rotary switch knob (page 16, 19)

Rotate the knob to turn on/off your turntable or select the rotation speed appropriate to the vinyl record to play.

**5** Dust cover (page 8, 13)

**6** Dust cover hinges (page 8, 13)

**7** Counterweight (page 8, 11)

Rotate the counterweight to adjust the tone arm balance and the stylus pressure after you have assembled your turntable.

**8** Anti-skating knob (page 10, 12)

Rotate this knob to adjust the anti-skating force after you have assembled your turntable.

**9** Tone arm lock (page 11, 16, 17)

Lock the tone arm to protect it against physical shock when you do not intend to play a vinyl record.

**10** Tone arm lifter lever (page 16)

Use this lever to raise or lower the tone arm. The tone arm descends slowly.

**11** Tone arm rest (page 11, 17)

Place the tone arm here while you are not playing a vinyl record.

**12** Tone arm (page 10, 16, 17)

**13** Stylus (page 20)

### Note

The stylus is a high precision component. Handle it with care to avoid damage.

**14** Cartridge body (page 20)

**15** Headshell (page 16)

# Rear

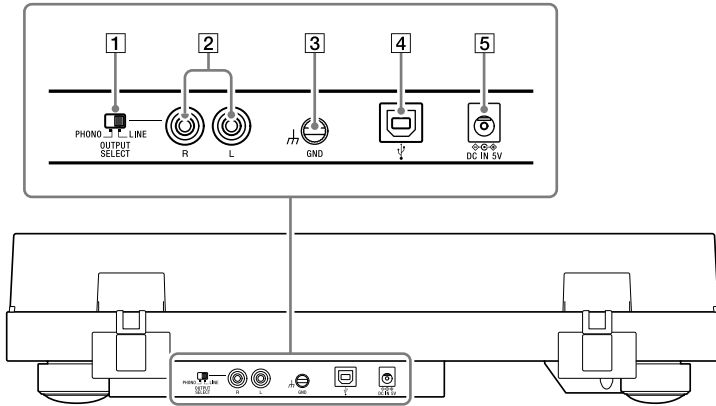

**1** PHONO/LINE switch (page 14)

Use this switch to select the audio output type appropriate to your connected audio device, such as a stereo system or an amplifier.

**2** Audio output (page 14)

**3**  $\hbar$  Grounding terminal (page 14)

**4**  $\Psi$  USB port (Type B) (page 19)

Use this port to connect a computer for recording.

**5**  $\diamond\text{e}\diamond$  DC IN (page 15)

# Getting Started

## Unpacking

Make sure that you have all of the supplied accessories listed below. If you find anything missing, contact your dealer or the customer support website. (See page 26.)

- Platter (with drive belt) (1)

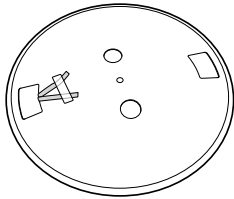

- Rubber mat (1)

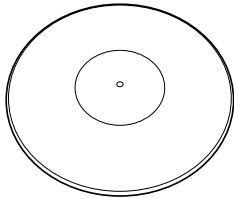

- Dust cover (1)

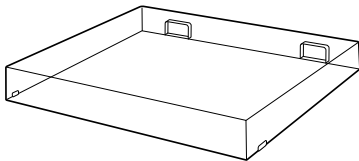

- Counterweight (1) \*



- 45 rpm adaptor (1) \*

Place the adaptor on the spindle for playing a 17 cm (7 inch) vinyl record.



- Dust cover hinges (2) \*

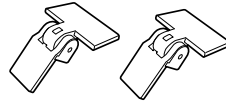

- AC adaptor (1)

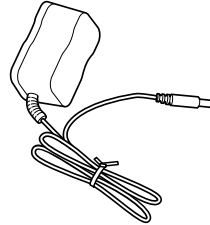

- PHONO cables with grounding wires (1)

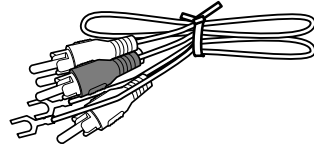

- USB cable (1)

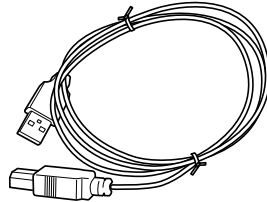

- Operating Instructions (this manual)

\* The counterweight, 45 rpm adaptor, and dust cover hinges are attached to a side surface of your turntable's packaging material.

### Note

Keep the packaging materials in case you need to transport your turntable for repair.



# Assembling the Turntable

## Note

Do not connect your turntable to a power outlet with the AC adaptor until you are finished with assembly.

## Precautions on placement

- Place the unit on a level surface.
- Avoid placing the unit near electrical appliances (such as a television, hair dryer, or fluorescent lamp) which may cause hum or noise.
- Place the unit where it will not be subject to any vibration, such as from speakers, slamming of doors, etc.
- Keep the unit away from direct sunlight, extremes of temperature, and excessive dust and moisture.
- Keep the unit away from electronic devices that may emit radio waves or electromagnetic noise.

## Attaching the platter

- 1 Place the platter on the spindle.  
Keep the platter level while placing it on the spindle.

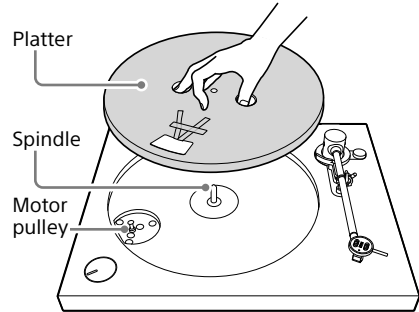

## Note

Hold the platter firmly so as not to drop the platter as it may cause personal injuries or damage to your turntable.

- 2 Turn the platter to the position where you can see the motor pulley through the rectangular hole with the tips of the red ribbon taped on the platter.

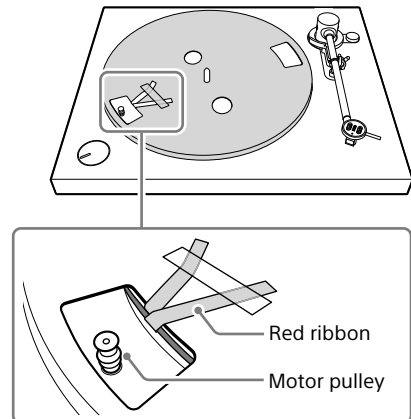

- 3** Peel off the adhesive tape, pull and hold the red ribbon, and then hook the drive belt around the motor pulley.

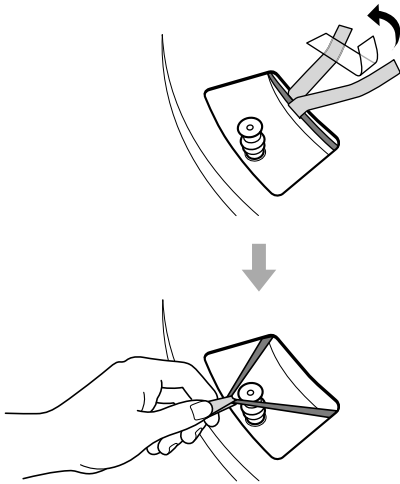

**Note**

- Do not twist the drive belt.
- Be sure to remove it once you have hooked the drive belt around the motor pulley.

- 4** Place the rubber mat onto the platter.

**Note**

Make sure that the chamfered side of the rubber mat faces upward. The back side of the rubber is indicated by the SONY imprint.

## Adjusting the tone arm balance

Adjust the tone arm balance to keep the tone arm horizontally balanced (zero balance) so that proper stylus pressure is exerted on the vinyl record.

- 1** Remove the stylus protective cover.

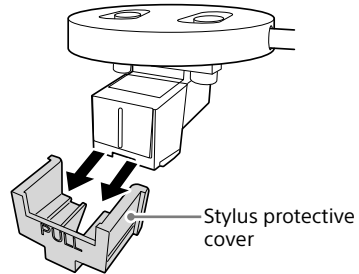

**Note**

Remove the stylus protective cover with care so as not to damage the stylus.

- 2** Make sure that the gauge number "0" on the anti-skating knob is aligned with the reference line.

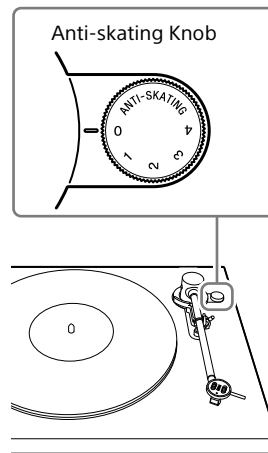

- 3** Attach the counterweight onto the back of the tone arm.

Slightly push in the counterweight and rotate in the direction of the arrow until the face of the gauge ring comes close to the white line on the tone arm.

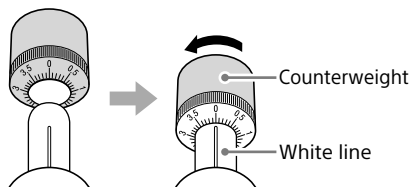

**Tip**

You can rotate the counterweight clockwise to move it outward or counterclockwise (in the direction of the black arrow above) to move it inward.

- 4** Unlock the tone arm lock and raise the tone arm from the tone arm rest.

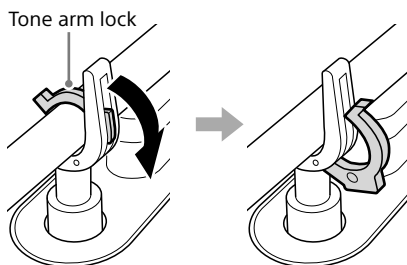

- 5** Rotate the counterweight clockwise or counterclockwise until the tone arm is horizontally balanced.

You may find it easier to adjust the tone arm balance that you rotate the counterweight a little at a time and take your hands off to see if the tone arm is horizontally balanced.

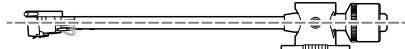

**Note**

Keep the tip of the stylus untouched with the rubber mat or the platter while adjusting the tone arm balance.

- 6** Put the tone arm back onto the tone arm rest.

## Adjusting the stylus pressure and the anti-skating force

Once the tone arm is horizontally balanced, adjust the stylus pressure and the anti-skating force.

- 1 Rotate only the gauge ring on the counterweight to bring the gauge number "0" on the ring into alignment with the white line on the tone arm.

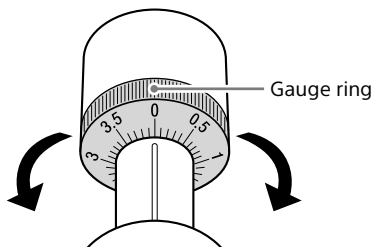

### Note

Do not rotate the counterweight along with the gauge ring.

- 2 Rotate the counterweight counterclockwise to bring the gauge number "3" on the gauge ring into alignment with the white line on the tone arm.

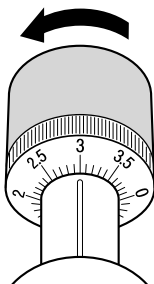

### Tip

An appropriate stylus pressure value is recommended for every cartridge. To protect the stylus and the record against damage,

adjust the stylus pressure to the recommended value. On your turntable, set the stylus pressure to "3."

- 3 Rotate the anti-skating knob to bring the gauge number "3" into alignment with the reference line.

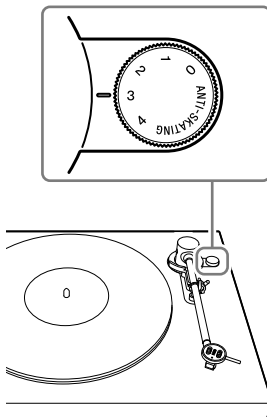

### Tip

- The anti-skating adjustment is required to apply proper anti-skating force that cancels out the inward force produced by the spinning platter while a vinyl record is being played.
- You need to set the anti-skating force to the same value as the stylus pressure you set in step 2.

# Attaching the Dust Cover

## Note on carrying this product

When you carry this product, make sure that you firmly hold the bottom of the product as illustrated below. Inappropriate holding may cause you to drop the product, resulting in malfunctions or injuries.

- 1 Insert the supplied dust cover hinges to the hinge pockets on the dust cover.

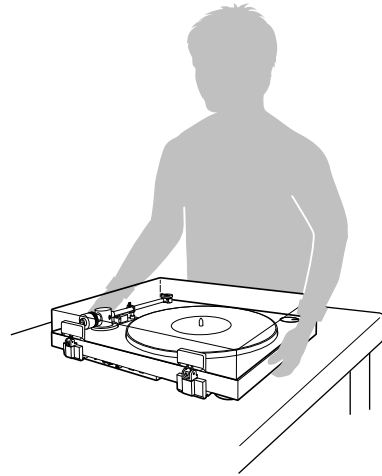
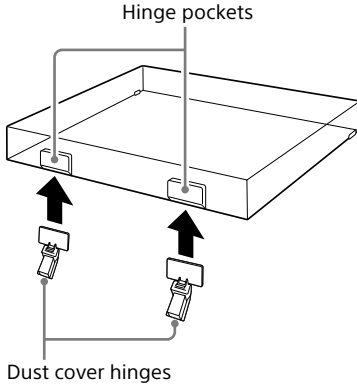

- 2 Align the attached hinges with the hinge pockets on the rear of your turntable and push in the dust cover.

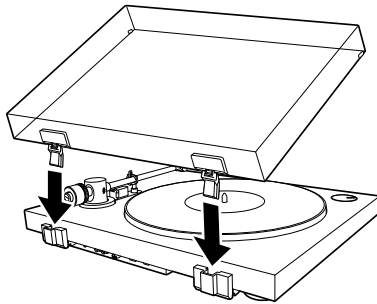

**Tip**

To remove the dust cover from the turntable, fully open the dust cover, grasp both sides near the bottom of the cover, and then gently pull it out in the upward direction.

# Listening to a Vinyl Record

## Connecting an Audio Device

### Note

- Be sure to turn off the audio device, such as a stereo system or an amplifier, before connection.
- Be sure to make all the connections before you connect the AC adaptor to a power outlet.

- 1 Make sure that the PHONO/LINE switch on the rear of your turntable is set to LINE.

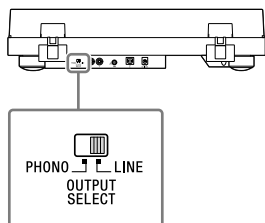

### Tip

If you want to use the PHONO input jacks on your audio device for connection, set the PHONO/LINE switch to PHONO. This, however, will significantly lower the audio output level.

- 2 Connect the supplied PHONO cables to the AUX or analog input jacks on the audio device.

Plug the white plug of the cable to the white (L) jack and the red plug to the red (R) jack.

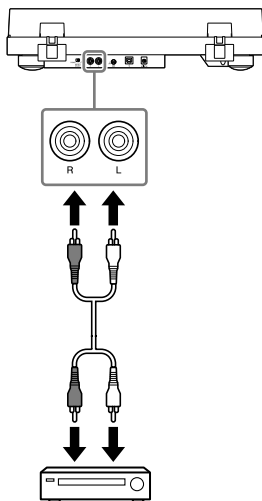

### Note

Be sure to insert the plugs firmly into the jacks. Loose connection will cause playback noises.

### Tip

Your audio devices may have the grounding terminal near the PHONO input jacks. Connecting the grounding terminals on the turntable and the audio device with a grounding wire may reduce playback noises.

### 3 Connect the AC adaptor.

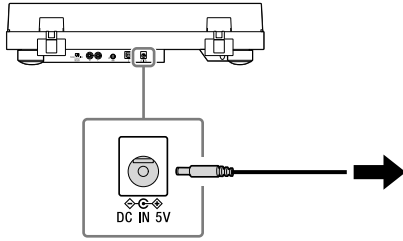

#### Note

To avoid noise interference, place the AC adaptor body away from your turntable as far as possible.

## Playing a Vinyl Record

#### Note

Before you play a vinyl record, turn down the volume of the connected audio device (an amplifier, speakers, etc.) to avoid a possible loud crackling noise. The crackling noise made by the stylus coming into contact with the vinyl record could damage the audio device. Wait until the stylus is completely placed on the vinyl record, and then turn up the volume.

### 1 Place a vinyl record onto the platter.

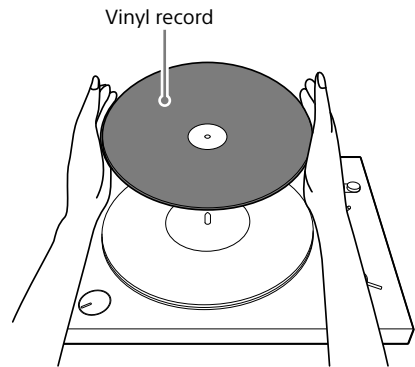

#### Note

Place only one vinyl record on the platter at a time.

#### To play a 17 cm (7 inch) vinyl record

Place the supplied 45 rpm adaptor on the spindle.

- 2** Rotate the SPEED/POWER rotary switch knob to select the rotation speed appropriate to the vinyl record.

The platter starts turning.

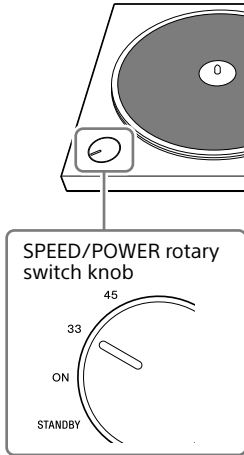

**Tip**

The rotation speed is usually printed on the center label of the vinyl record or the record jacket.

- 3** Unlock the tone arm lock and push the tone arm lifter lever toward the back of the turntable.

The tone arm slowly ascends.

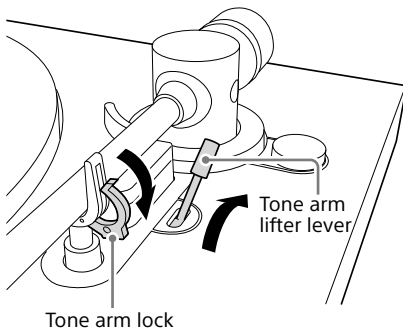

- 4** Move the tone arm to the position over the desired track.

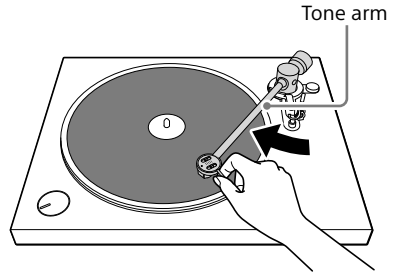

**Note**

To move the tone arm, gently hold the headshell.

- 5** Pull the tone arm lifter lever toward the front of the turntable.

The tone arm slowly descends and playback starts.

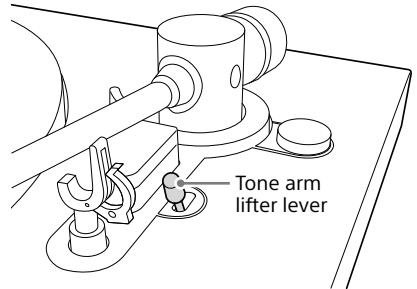

To stop the playback before it finishes, push the tone arm lifter lever toward the back of the turntable.

The tone arm slowly ascends and the playback stops.

**Note**

- When closing the dust cover, close it slowly to avoid making physical force that may cause the stylus to skip.
- During playback, keep your hands away from the tone arm and the turning vinyl record.
- During playback, do not stop the rotation of the platter by hand.



**Tip**

Using the tone arm lifter lever prevents scratches on the vinyl record and ensures smooth playback.

## When playback is finished

- 1** Push the tone arm lifter lever toward the back of the turntable.
- 2** Move the tone arm back to the tone arm rest.
- 3** Pull the tone arm lifter lever toward the front of the turntable and secure the tone arm with the tone arm lock.
- 4** Rotate the SPEED/POWER rotary switch knob to select "STANDBY."  
The platter stops turning and the turntable turns off.

## Recording a Vinyl Record

### Recording Audio Tracks onto a Computer

You can connect your turntable and a computer with the supplied USB cable and use the Hi-Res Audio Recorder application to record audio tracks of a vinyl record onto the computer. The Hi-Res Audio Recorder application is a recording application exclusively designed for this turntable product.

For information on how to use the Hi-Res Audio Recorder application, refer to the Hi-Res Audio Recorder help at: <http://rd1.sony.net/help/ha/hrar/>

#### Note

- To record audio tracks of a vinyl record onto a computer, you need to install the Hi-Res Audio Recorder application on the computer. With the computer that does not have the application installed, you cannot record audio tracks when it is connected to your turntable.
- To download the Hi-Res Audio Recorder application, you need a computer with Internet connection.
- The Hi-Res Audio Recorder application is merely a recording application. It is not capable of playback.
- The USB output signals can be used only for recording, not for playback.

#### Tip

To transfer high-resolution audio sources recorded on a computer to another audio device for playback, you need an audio device that supports high resolution audio playback.

### System requirements

#### Windows

Operating systems:

Windows 7 (32/64 bit)

Windows 8 (32/64 bit)

Windows 8.1 (32/64 bit)

Windows 10 (32/64 bit)

(The latest service pack is required.)

CPU: Intel Core2 Processor 1.6 GHz or higher

Memory: 1 GB or larger

Screen resolution: 1024 x 768 or higher

#### Mac

Operating systems:

Mac OS X 10.9

Mac OS X 10.10

Mac OS X 10.11

Screen resolution: 1024 x 768 or higher

Any operating systems other than the listed ones are not supported.

#### Note

This application is not assured to work successfully:

- on every computer with one of the listed operating systems
- on a homemade computer
- on a computer with a user-upgraded operating system
- on a multi-boot computer
- with the power-saving features of the computer: System Suspend or Sleep (Standby)

### 1 Download and install the Hi-Res Audio Recorder application onto the computer.

For detailed instructions, visit the website designated to your area of residency.

#### For customers in Europe:

Access <http://www.sony.eu/support>, switch to the website for your country, and then search for "Hi-Res Audio Recorder."

#### For customers in the U.S.A.:

Access <http://esupport.sony.com/> and search for "Hi-Res Audio Recorder."

#### For customers in Canada:

Access <http://esupport.sony.com/CA/> and search for "Hi-Res Audio Recorder."

#### For customers in other countries/ regions:

Access <http://www.sony-asia.com/support> and search for "Hi-Res Audio Recorder."

#### Note

If the latest Windows updates are not applied, the application may not be installed successfully. Start Windows Update and install the latest updates before you install the Hi-Res Audio Recorder application.

- 2** Connect a computer to your turntable.

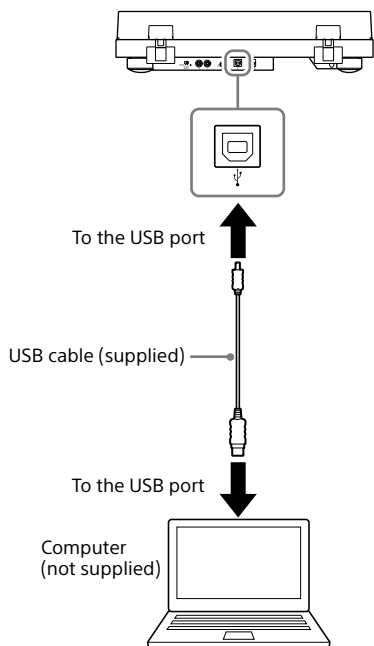

- 3** Rotate the SPEED/POWER rotary switch knob to select "ON" to turn on the turntable.

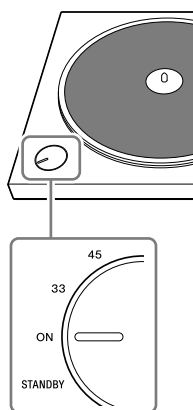

- 4** Use the Hi-Res Audio Recorder application to record audio tracks onto the computer.

For detailed instructions on using the Hi-Res Audio Recorder application and transferring audio tracks to a high resolution audio device, refer to the Hi-Res Audio Recorder Help at <http://rd1.sony.net/help/ha/hrar/>.

**Note**

- Be sure to use only the supplied USB cable when connecting a computer to your turntable. Do not use a USB hub or a USB extension cable for connection.
- Be sure to insert the USB cable plug straight and all the way into the USB port. Do not force it obliquely into the port as it may cause malfunctions.
- When you do not intend to record audio tracks onto a computer, it is recommended that you disconnect the USB cable from your turntable. With a computer connected to the turntable via the USB port, playback with the connected audio device may cause noises.
- When a computer is connected to your turntable with a USB cable for recording, regardless of the PHONO/LINE switch selection on the back of the turntable, playing a vinyl record sends audio data optimized by the turntable's equalizer to the USB port on the computer.

## Maintenance

### Cleaning the Stylus

The stylus is a high precision component. Handle it with care to avoid damage. Use a commercial cleaning product for cleaning the stylus.

### Replacing the Stylus

The stylus may become worn out, damaged, or dirty beyond cleaning depending on your use case. In such a case, replace the stylus.

To obtain a spare stylus, contact your dealer or the customer support website. (See page 26.)

#### Note

Be sure to attach the stylus protective cover before you replace the stylus so as not to harm your fingertips or damage the stylus.

#### To remove the stylus

1 Turn off your turntable and the connected audio device and unplug the AC adaptor from the power outlet.

2 Attach the stylus protective cover to the stylus.

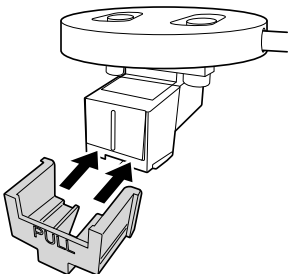

3 Hold the cartridge body (1) with one hand, grasp the stylus with the other, and then pull the stylus in the direction of the arrow to remove it from the cartridge body.

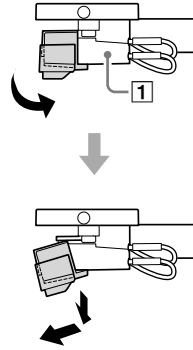

#### To attach the stylus

1 Attach the stylus protective cover to the spare stylus.

2 Hold the cartridge body (1) with one hand and then insert the tab on the spare stylus into the receptacle on the cartridge body.

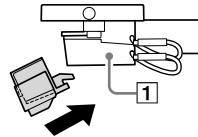

3 Push the stylus in the direction of the arrow until it clicks into place.

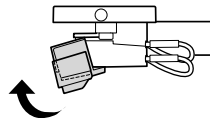

## Replacing the Drive Belt

The drive belt will wear or may even break over time. In such a case, replace it with a new one.

To obtain a spare drive belt, contact your dealer or the customer support website. (See page 26.)

- 1 Turn off your turntable and the connected audio device and unplug the AC adaptor from the power outlet.

- 2 Remove the rubber mat.

- 3 Unhook the drive belt from the motor pulley.

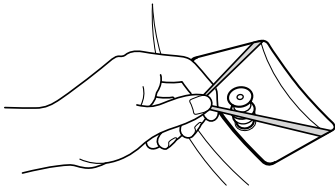

- 4 Put your finger and thumb into the platter's round holes to hold the platter and remove the platter.

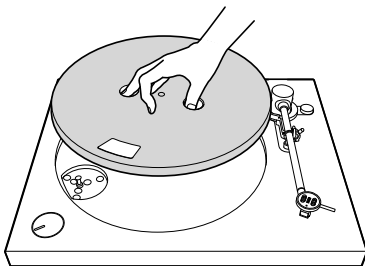

- 5 Turn the platter upside down and remove the drive belt.

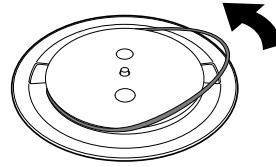

- 6 Wind a new drive belt around the platter while keeping it untwisted. Follow the steps in "Assembling the Turntable" to finish assembly. (See page 9.)

### Note

Spare drive belts do not have the red indication ribbon attached.

## Cleaning the Dust Cover and the Turntable Body

Use a dry, soft cloth to clean the dust cover and the turntable body.

When it is hard to wipe off the soil, use a cloth moistened with a mild detergent solution. Do not use any chemical solution, such as alcohol, benzene, or paint thinner, that damages the finish.

## Additional Information

### Precautions

#### On safety

- Before operating the unit, check that the operating voltage of your unit is identical with that of your local power supply.
- Should any solid object or liquid fall into the cabinet, unplug the unit and have it checked by qualified personnel before operating it any further.
- Unplug the unit from the wall outlet if it is not to be used for an extended period of time. To disconnect the cord, pull it out by the plug.  
Never pull the cord itself.

#### On repacking

Keep the carton and packing materials. They provide an ideal container to transport the unit. If you have any question or problem concerning your unit that is not covered in this manual, please consult your nearest Sony dealer.

#### Note on recording

The recorded music is limited to private use only. Use of the music beyond this limit requires permission of the copyright holders.

### Trademarks

- IBM and PC/AT are registered trademarks of International Business Machines Corporation.
- Microsoft, Windows and Windows Media are either trademarks or registered trademarks of Microsoft Corporation in the United States and/or other countries.
- Mac, Mac OS and OS X are trademarks of Apple Inc., registered in the U.S. and other countries.
- ASIO is a trademark of Steinberg Media Technologies GmbH.
- DSD is a registered trademark of Sony Corporation.
- All other trademarks and registered trademarks are trademarks or registered trademarks of their respective holders. In this manual, ™ and ® marks are not specified.

## Troubleshooting

When you find your turntable not working properly, first review the following suggestions before you consider requesting for repair. If they do not help solving your problem, contact your dealer or the customer support website. (See page 26.)

### Vinyl record playback

You hear no sounds from the computer or audio device connected via the USB port.

- ➔ To listen to a vinyl record, you need to connect an audio device with the supplied PHONO cables. (See page 8.)
- ➔ Use the USB port to connect a computer for recording audio tracks with the Hi-Res Audio Recorder application exclusively designed for this turntable product. You cannot use the USB port for connection with an audio device.

The tone arm skips, skates, or stays on the same track.

- ➔ The counterweight is not properly adjusted. When you adjust the stylus pressure, rotate the counterweight, not the gauge ring. (See page 12.)
- ➔ The platter is not positioned level. Place your turntable on a level surface.
- ➔ The vinyl record is dusty or scratched. Clean the surface with a commercial record cleaning product or replace the vinyl record.

You experience sound problems.

- ➔ If the dirty stylus is causing frequent noises, clean the stylus with a commercial stylus cleaning product. If the stylus is worn out, replace the stylus. (See page 20.)
- ➔ The drive belt may be worn out. Replace the drive belt. (See page 21.)
- ➔ If the dusty vinyl record is causing frequent noises, clean the surface with a commercial record cleaning product.
- ➔ Make sure that the stylus pressure and the anti-skating force are properly set. (See page 12.)
- ➔ The stylus is worn out. Replace it with a new one. (See page 20.)

---

### You hear rumbling or low-frequency howling noises\*.

- ➔ Your turntable is placed too close to speakers. Move the turntable away from the speakers.

\* This phenomenon, called "acoustic feedback," occurs when vibrations that travel through the air or solid objects (such as shelves, a cabinet, or the floor) from speakers are picked up by the stylus, amplified and reproduced through the speakers.

---

### You hear noises.

- ➔ Make sure that the PHONO/LINE switch on the rear of your turntable is set to LINE. If the PHONO/LINE switch is set to PHONO when the turntable is connected to any other input jacks than the PHONO input jacks on the audio device, you may hear playback noises. When the PHONO/LINE switch is set to LINE, do not connect the turntable to the PHONO input jacks on the audio device.
  - ➔ Make sure that a computer is NOT connected to your turntable with a USB cable. With a computer connected to the turntable via the USB port, playback with the connected audio device may cause noises.
- 

### The sound pitch is too high or low.

- ➔ A wrong rotation speed is selected. Check the center label of the vinyl record or the record jacket for the rotation speed and select the appropriate one. Rotate the SPEED/POWER rotary switch knob to select "33" for 33 1/3 rpm records or "45" for 45 rpm records.
  - ➔ The drive belt may be twisted or worn out. Untwist the drive belt. (See page 21.)
- 

### The sound pitch fluctuates.

- ➔ Make sure that the stylus pressure and the anti-skating force are properly set. (See page 12.)
  - ➔ The stylus is worn out. Replace it with a new one. (See page 20.)
- 

### The drive belt is worn out or broken.

- ➔ Replace the drive belt. (See page 21.) To obtain a spare drive belt, contact your dealer or the customer support website. (See page 26.)
- 

### The platter does not turn.

- ➔ Make sure that the AC adaptor is firmly connected to a power outlet and the DC IN on your turntable.
  - ➔ Make sure that the drive belt is completely hooked around the motor pulley. (See page 10.)
- 

---

### Playback sound is too low in volume or distorted.

- ➔ Make sure that the PHONO/LINE switch selection on your turntable matches the type of the input jacks on the audio device used for connection with the turntable. (See page 14.)
- 

## Software installation

---

### You cannot install the Hi-Res Audio Recorder application onto a computer.

- ➔ Visit our support website for detailed instructions on downloading and installing the application.  
**For customers in Europe:**  
Access <http://www.sony.eu/support>, switch to the website for your country, and then search for "Hi-Res Audio Recorder."  
**For customers in the U.S.A.:**  
Access <http://esupport.sony.com/> and search for "Hi-Res Audio Recorder."  
**For customers in Canada:**  
Access <http://esupport.sony.com/CA/> and search for "Hi-Res Audio Recorder."  
**For customers in other countries/regions:**  
Access <http://www.sony-asia.com/support> and search for "Hi-Res Audio Recorder."
- ➔ Make sure that the computer has Internet connection.

---

## Repair Services

When you find your turntable not working properly, first review the suggestions listed in “Troubleshooting” to find out if your problem needs repair.

If the suggestions do not help solving the problem, contact your dealer or the customer support website. (See page 26.)

Spare components retention period:  
Sony retains functional turntable components for repair (components required to maintain the turntable functions) for at least eight years after discontinuation of the product, as instructed by the Ministry of Economy, Trade and Industry of Japan, and will provide repair services during this retention period. Depending on the component that needs repair, however, repair services may still be provided beyond the retention period. For more information, contact the customer support website. (See page 26.)

Before you contact your dealer or the customer support website (See page 26.), you are advised to have the following information at hand:

- Model number: PS-HX500
- Serial number on the back of your turntable:
- Description of the defect(s): Please describe as much as you can.
- Date of your purchase:
- Your dealer name:

If the stylus or the drive belt is damaged or worn out due to improper use, repair services will be provided at your expense.



# Specifications

## Motor and Platter

<b>Drive system</b>	Belt-drive
<b>Motor</b>	DC motor
<b>Platter</b>	296 mm dia. (aluminum die-cast)
<b>Speeds</b>	33 1/3 and 45 rpm, 2 speed
<b>Wow and flutter</b>	0.1% (WRMS)
<b>S/N ratio</b>	More than 50 dB (DIN-B) with the supplied cartridge

## Tone Arm

<b>Type</b>	Straight arm
<b>Effective arm length</b>	221 mm

## USB Connectivity

<b>Output port</b>	USB Type B
	USB 2.0

## Cartridge

<b>Type</b>	MM
<b>Stylus pressure</b>	3 g
<b>Output level</b>	2.5 mV

## General

<b>Power supply</b>	DC 5 V 2.0 A (AC adaptor)
<b>Power consumption</b>	3 W
<b>Dimensions</b>	430 x 104 x 366 mm (16 7/8 x 4 1/8 x 14 3/8 in) (width/height/depth)
<b>Weight</b>	Approx. 5.4 kg (11.9 lb 19.5 oz)

## AC adaptor

<b>Input</b>	AC 100-240 V 0.35 A 50/60 Hz
<b>Output</b>	DC 5 V 2.0 A

Design and specifications are subject to change without notice.

---

## Customer Support Websites

For information about purchasing spare components, accessories, and other support services, visit the customer support website designated to your area of residency.

### For customers in Europe:

<http://www.sony.eu/support>

### For customers in the U.S.A.:

<http://esupport.sony.com/US>

### For customers in Canada:

<http://esupport.sony.com/CA/>

### For customers in other countries/ regions:

Access <http://www.sony-asia.com/support> and search for "Hi-Res Audio Recorder."

---

## Index

45 rpm adaptor .....	8, 15
AC adaptor .....	8, 15
adjusting .....	10, 12
anti-skating knob.....	6, 10, 12
audio output .....	7, 14
cartridge body .....	6, 20
counterweight .....	6, 8, 11
customer support websites.....	26
DC IN .....	7, 15
dust cover hinges .....	6, 8, 13
gauge ring.....	12
grounding terminal.....	7, 14
headshell.....	6, 16
Hi-Res Audio Recorder application .....	4, 18, 19, 23
install.....	4, 18, 23
motor pulley.....	9, 10, 21
noise.....	9, 22, 23
PHONO cables.....	8, 14
PHONO/LINE switch.....	7, 14
platter.....	6, 8, 9, 23
repair services .....	24
rotation speed.....	16
rubber mat .....	6, 8, 10
SPEED/POWER rotary switch knob .....	6, 16, 17, 19
spindle .....	6, 9
stylus pressure .....	12
tone arm.....	6, 10, 11, 16, 17, 22
tone arm lifter lever .....	6, 16, 17
tone arm lock.....	6, 11, 16, 17
trademarks .....	22
USB cable .....	8, 19
USB port .....	7, 19, 22





\* 4 5 8 5 8 3 4 1 3 \* (1)