

# Microwave Solo Oven Instruction

---

EM131A5C-BS



# TOSHIBA



# Welcome to the world of **TOSHIBA**

BEFORE OPERATING THIS PRODUCT,  
READ, UNDERSTAND, AND FOLLOW THESE INSTRUCTIONS.  
BE SURE TO SAVE THIS BOOKLIST FOR FUTURE REFERENCE

## **CONTENTS**

**PRECAUTIONS TO AVOID POSSIBLE EXPOSURE TO EXCESSIVE  
MICROWAVE ENERGY**

**IMPORTANT SAFETY INSTRUCTIONS**

**GROUNDING INSTRUCTIONS**

---

**UTENSILS**

**SETTING UP YOUR OVEN**

---

**OPERATION**

**MAINTENANCE**

# **PRECAUTIONS TO AVOID POSSIBLE EXPOSURE TO EXCESSIVE MICROWAVE ENERGY**

---



1. Do not attempt to operate this oven with the door open since this can result in harmful exposure to microwave energy. It is important not to defeat or tamper with the safety interlocks.
2. Do not place any object between the oven front face and the door or allow soil or cleaner residue to accumulate on sealing surfaces.
3. Do not operate the oven if it is damaged. It is particularly important that the oven door closes properly and that there is no damage to the:
  - a. DOOR (bent)
  - b. HINGES AND LATCHES (broken or loosened)
  - c. DOOR SEALS AND SEALING SURFACE
4. The oven should not be adjusted or repaired by anyone except properly qualified service personnel.

## **Specifications**

Model:	EM131A5C-BS
Rated Voltage:	120V~ 60Hz
Rated Input Power(Microwave):	1550W
Rated Output Power(Microwave):	1100W
Oven Capacity:	1.2 cu.ft.
Turntable Diameter:	Ø12.4 inch
External Dimensions:	20.51X17.14X12.83 inch
Net Weight:	Approx. 34.6 Lbs

# IMPORTANT SAFETY INSTRUCTIONS WARNING

---



**To reduce the risk of burns, electric shock, fire, injury to persons or exposure to excessive microwave oven energy when using your appliance, follow basic safety precautions, including the following:**

1. Read all instructions before using the appliance.
2. Read and follow the specific: " PRECAUTIONS TO AVOID POSSIBLE EXPOSURE TO EXCESSIVE MICROWAVE ENERGY" found on page 2.
3. As with most cooking appliances, close supervision is necessary to reduce the risk of a fire in the oven cavity.
4. To reduce the risk of fire in the oven cavity:
  - a. Do not overcook food. Carefully attend the appliance when paper, plastic, or other combustible materials are placed inside the oven to facilitate cooking.
  - b. Remove wire twist-ties and metal handles from paper or plastic containers/ bags before placing them in the oven.
  - c. If materials inside the oven ignite, keep the oven door closed. Turn the oven off, and unplug the appliance. Disconnect the power cord, shut off power at the fuse or circuit breaker panel.
  - d. Do not use the cavity for storage purposes. Do not leave paper products, cooking utensils, or food in the cavity when not in use.
5. This oven must be grounded. Connect only to properly grounded outlet. See "GROUNDING INSTRUCTIONS" found on page 6.
6. Install or locate this oven only in accordance with the installation instructions provided.
7. Some products such as whole eggs and sealed containers-for example, closed glass jars-are able to explode and should not be heated in the oven.

# IMPORTANT SAFETY INSTRUCTIONS WARNING

---



8. Use this appliance only for its intended uses as described in this manual. Do not use corrosive chemicals or vapors in this appliance. This oven is specifically designed to heat or cook or dry food. It is not designed for industrial or laboratory use.
9. As with any appliance, close supervision is necessary when used by children.
10. Do not operate this oven if it has a damaged cord or plug, if it is not working properly or if it has been damaged or dropped.
11. This microwave should be serviced only by qualified service personnel. Contact nearest authorized service facility for examination, repair or adjustment.
12. Do not cover or block any openings on the oven.
13. Do not store or use this appliance outdoors.
14. Do not use this oven near water, for example, near a kitchen sink, in a wetbasement, near a swimming pool, or similar locations.
15. Do not immerse cord or plug in water.
16. Keep cord away from heated surfaces.
17. Do not let cord hang over edge of table or counter.
18. When cleaning surfaces of door and oven that comes together on closing the door, use only mild, nonabrasive soaps or detergents applied with a sponge or soft cloth.
19. This appliance is for private household use only.

# IMPORTANT SAFETY INSTRUCTIONS WARNING

---



20. Liquids, such as water, coffee, or tea are able to be overheated beyond the boiling point without appearing to be boiling. Visible bubbling or boiling when the container is removed from the microwave oven is not always present. THIS COULD RESULT IN VERY HOT LIQUIDS SUDDENLY BOILING OVER WHEN THE CONTAINER IS DISTURBED OR A SPOON OR OTHER UTENSIL IS INSERTED INTO THE LIQUID.
- Do not overheat the liquid.
  - Stir the liquid both before and halfway through heating it.
  - Do not use straight-sided containers with narrow necks.
  - After heating, allow the container to stand in the microwave oven for a short time before removing the container.
  - Use extreme care when inserting a spoon or other utensil into the container.

## SAVE THESE INSTRUCTIONS

# GROUNDING INSTRUCTIONS

---



## DANGER

Electric Shock Hazard

Touching some of the internal components can cause serious personal injury or death. Do not disassemble this appliance.

This appliance must be grounded. In the event of an electrical short circuit, grounding reduces the risk of electric shock by providing an escape wire for the electric current. To protect against electrical shock, this appliance is equipped with a cord having a 3 prong grounding-type plug for insertion into a proper grounding-type receptacle. DO NOT alter the plug for use in a 2-prong receptacle. If the plug will not fit into a receptacle, have the proper receptacle installed by a qualified electrician.

### CAUTION:

Do not insert your fingers into any gaps or holes; it may cause injuries.

---

## WARNING

Improper use of the grounding can result in a risk of electric shock

Three-pronged  
(grounding) plug





# GROUNDING INSTRUCTIONS

---



Consult a qualified electrician or serviceman if the grounding instructions are not completely understood or if doubt exists as to whether the appliance is properly grounded. If it is necessary to use an extension cord, use only a 3-wire extension cord that has a 3-pronged grounding plug, and a 3-slot receptacle that will accept the plug on the appliance. The marked rating of the extension cord shall be equal to or greater than the electrical rating of the appliance.

1. A short power-supply cord is provided to reduce the risks resulting from becoming entangled in or tripping over a longer cord.
2. Longer cord sets or extension cords are available and may be used if care is exercised in their use.
3. If a long cord sets or extension cord is used:
  - a. The marked electrical rating of the cord set or extension cord should be at least as great as the electrical rating of the appliance.
  - b. The extension cord must be a grounding -type 3-wire cord.
  - c. The longer cord should be arranged so that it will not drape over the counter-top or tabletop where it can be pulled on by children or tripped over unintentionally.

# GROUNDING INSTRUCTIONS

---



## RADIO INTERFERENCE

Operation of the microwave oven may cause interference to your radio, TV or similar equipment.

When there is interference, it may be reduced or eliminated by taking the following measures:

- a. Clean door and sealing surface of the oven.
- b. Reorient the receiving antenna of radio or television.
- c. Relocate the microwave oven with respect to the receiver.
- d. Move the microwave oven away from the receiver.
- e. Plug the microwave oven into a different outlet so that microwave oven and receiver are on different branch circuits.

# GROUNDING INSTRUCTIONS

---



## UTENSILS

---

### CAUTION

Electric Shock Hazard

Tightly-closed utensils could explode. Closed containers should be opened and plastic pouches should be pierced before cooking.

See the instructions on "Materials you can use in microwave oven or to be avoided in microwave oven". There may be certain non-metallic utensils that are not safe to use for microwaving. If in doubt, you can test the utensil in question following the procedure below.

## SAVE THESE INSTRUCTIONS HOUSEHOLD INDOOR USE ONLY

### UTENSIL TEST:

1. Fill a microwave-safe container with 1 cup of cold water (250ml) along with the utensil in question.
2. Cook on maximum power for 1 minute.
3. Carefully feel the utensil. If the empty utensil is warm, do not use it for microwave cooking.
4. Do not exceed 1 minute cooking time.

# MATERIALS YOU CAN USE IN MICROWAVE OVEN

UTENSILS	REMARKS
Browning dish	Follow manufacturer's instructions. The bottom of browning dish must be at least 3/16 inch (5mm) above the turntable. Incorrect usage may cause the turntable to break.
Dinnerware	Microwave-safe only. Follow manufacturer's instructions. Do not use cracked or chipped dishes.
Glass jars	Always remove lid. Use only to heat food until just warm. Most glass jars are not heat resistant and may break.
Glassware	Heat-resistant oven glassware only. Make sure there is no metallic trim. Do not use cracked or chipped dishes.
Oven cooking bags	Follow manufacturer's instructions. Do not close with metal tie. Make slits to allow steam to escape.
Paper plates and cups	Use for short-term cooking/warming only. Do not leave oven unattended while cooking.
Paper towels	Use to cover food for reheating and absorbing fat. Use with supervision for a short-term cooking only.
Parchment paper	Use as a cover to prevent splattering or a wrap for steaming.
Plastic	Microwave-safe only. Follow the manufacturer's instructions. Should be labeled "Microwave Safe". Some plastic containers soften, as the food inside gets hot. "Boiling bags" and tightly closed plastic bags should be slit, pierced or vented as directed by package.
Plastic wrap	Microwave-safe only. Use to cover food during cooking to retain moisture. Do not allow plastic wrap to touch food.
Thermometers	Microwave-safe only (meat and candy thermometers).
Wax paper	Use as a cover to prevent splattering and retain moisture.

# MATERIALS TO BE AVOIDED IN MICROWAVE OVEN

UTENSILS	REMARKS
Aluminum tray	May cause arcing. Transfer food into microwave-safe dish.
Food carton with metal handle	May cause arcing. Transfer food into microwave-safe dish.
Metal twist ties	May cause arcing and could cause a fire in the oven.
Paper bags	May cause a fire in the oven.
Plastic foam	Plastic foam may melt or contaminate the liquid inside when exposed to high temperature.
Wood	Wood will dry out when used in the microwave oven and may split or crack.

# SETTING UP YOUR OVEN

## NAMES OF OVEN PARTS AND ACCESSORIES

Remove the oven and all materials from the carton and oven cavity. Your oven comes with the following accessories:

Glass Tray	1
Turntable ring	1
Instruction Manual	1

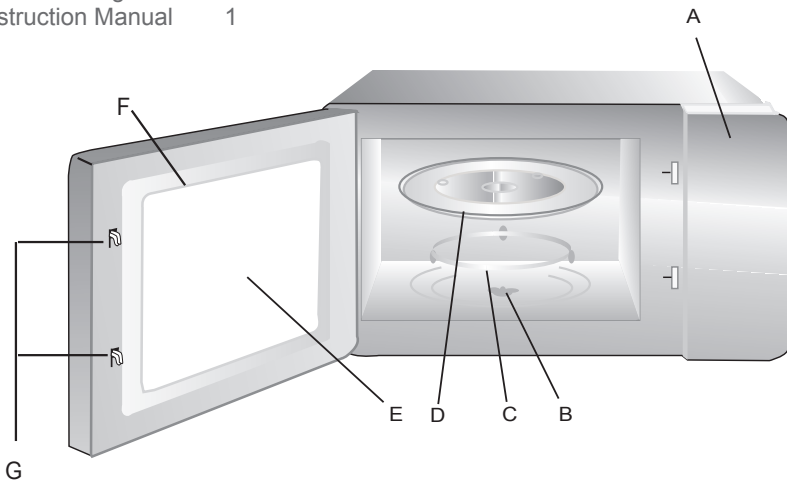

- A. Control panel
- B. Turntable shaft
- C. Turntable ring
- D. Glass tray
- E. Observation window
- F. Oven Door
- G. Safety interlock system

# SETTING UP YOUR OVEN

---

## TURNTABLE INSTALLATION

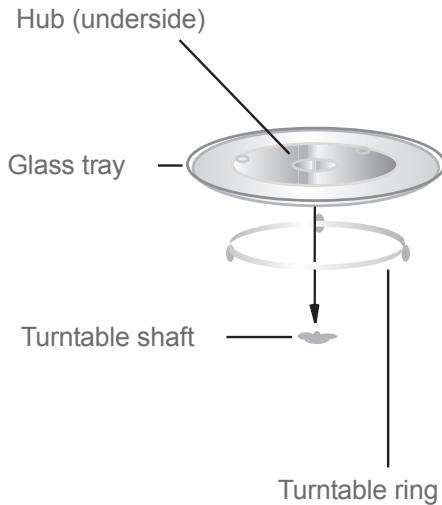

- Never place the glass tray upside down. The glass tray should never be restricted.
- Both glass tray and turntable ring must always be used during cooking.
- All food and containers of food are always placed on the glass tray for cooking.

# SETTING UP YOUR OVEN

## COUNTERTOP INSTALLATION

Remove all packing material and accessories. Examine the oven for any damage such as dents or broken door. Do not install if oven is damaged.

Cabinet: Remove any protective film found on the microwave oven cabinet surface. Do not remove the light brown Mica cover that is attached to the oven cavity to protect the magnetron.

---

## INSTALLATION

1. Select a level surface that provide enough open space for the intake and/or outlet vents.

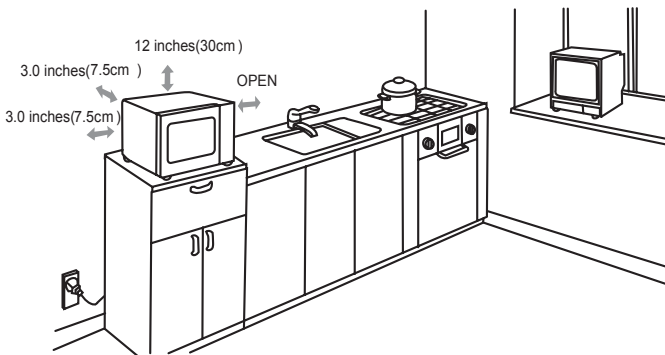

A minimum clearance of 3.0 inches (7.5cm) is required between the oven and any adjacent walls. One side must be open.

- (1) Leave a minimum clearance of 12 inches (30cm) above the oven.
- (2) Do not remove the legs from the bottom of the oven.
- (3) Blocking the intake and/or outlet openings can damage the oven.
- (4) Place the oven as far away from radios and TV as possible.

Operation of microwave oven may cause interference to your radio or TV reception.



# SETTING UP YOUR OVEN

---

## INSTALLATION

2. Plug your oven into a standard household outlet. Be sure the voltage and the frequency is the same as the voltage and the frequency on the rating label.

## WARNING

Do not install oven over a range cooktop or other heat-producing appliance. If installed near or over a heat source, the oven could be damaged and the warranty would be void.



The accessible surface may  
be hot during operation

# OPERATION

## CONTROL PANEL AND FEATURES

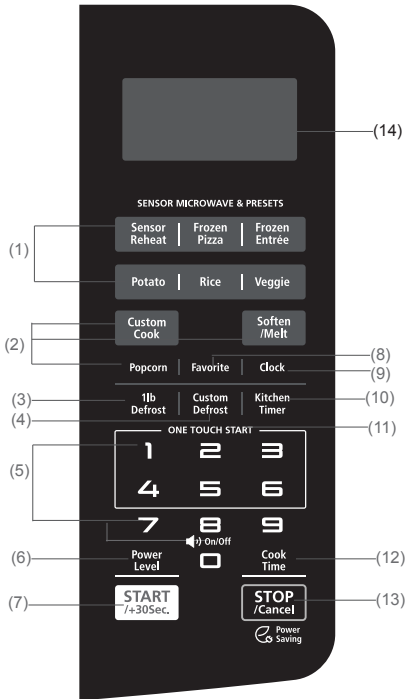

- (1) Quick Touch Presets--- Sensor Menu ( Sensor Reheat, Frozen Pizza, Frozen Entrée, Potato, Rice, Veggie )
- (2) Auto Menu (Custom Cook, Soften/Melt), Popcorn
- (3) Automatically defrosts one pound items
- (4) Custom Defrost: Defrost time calculated by entered weight and category of item
- (5) Number Pads
- (6) Power Level
- (7) START ADD 30 SEC
- (8) Favorite
- (9) Clock
- (10) Kitchen Timer
- (11) ONE TOUCH START Pads (1- 6)
- (12) Cook time
- (13) STOP Cancel Hold 3 sec: Before cooking starts, press to clear all previous settings. During cooking, press once to stop oven; press twice to stop oven and clear all settings.
- (14) Display Window

# OPERATION

## 1. POWER LEVELS

Ten power levels are available.

Press Time Cook , "00:00" will display, then press number pads.

Press Power Level and "PL10" will display. Then press number pads to select a different power level.

In cooking state of microwave, press "Power", the current power will be displayed for 3 seconds.

Example : To cook the food with 50% microwave power for 15 minutes.

a. Press Time Cook , "00:00" will display.

b. Press "1, 5, 0, 0" in order for 15:00 to appear in the display.

c. Press Power Level , then press "5" to select 50% microwave power.

d. Press **START** /+30Sec to start cooking. Buzzer sounds once. The remaining cooking time will display.

Level	10	9	8	7	6	5	4	3	2	1
Power	100%	90%	80%	70%	60%	50%	40%	30%	20%	10%
Display	PL10	PL 9	PL 8	PL 7	PL 6	PL 5	PL 4	PL 3	PL 2	PL 1

## 2. CLOCK SETTING

When the microwave oven is plugged into an outlet, "0:00" will display.

(1) Press Clock once, "00:00" will appear in the display.

(2) Press the number pads to enter the current clock time. For example, if the time is now 10:12, press " 1, 0, 1, 2 " in order.

(3) Press Clock to finish clock setting, " : " will flash and the numbers will appear as a clock time in the display.

### NOTE:

- If the numbers entered are not within the range between 1:00 to 12:59, the setting will not be accepted until valid numbers are entered.
- In the process of setting clock, if the **STOP** /Cancel pad is pressed or if there is no operation within 1 minute, the display will automatically return to the previous clock setting.

# OPERATION

---

## 3. KITCHEN TIMER

- (1) Press Kitchen Timer once, "00:00" will appear in the display.
- (2) Press the number pads to enter the time amount. The maximum amount of time that can be entered is 99 minutes, 99 seconds.
- (3) Press **START** /+30Sec to confirm setting, and the timer will start to count down.
- (4) When the time amount elapses, timer indicator will disappear. The oven will beep 5 times.

### Note:

- The Kitchen Timer setting is different from the Clock setting; it is simply a timer.
- During the Kitchen Timer function, no cooking function can be set into operation.
- Kitchen Timer amount cannot be increased by pressing **START** /+30Sec .
- Pressing **STOP** /Cancel will cancel the Timer countdown.

## 4.MICROWAVE COOK

- (1) Press Cook Time , "00:00" will appear in the display.
- (2) Press number pads to enter the cooking time. The maximum cooking time is 99 minutes,99 seconds.
- (3) Press Power Level, PL10 will flash. Press number pads 0 through 9 to select a different power level if desired. See the POWER LEVEL table above.
- (4) Press **START** /+30Sec to start cooking. The remaining cooking time will display.

Example : To cook the food with 50% microwave power for 15 minutes.



- a. Press Cook Time , "00:00" will display.
- b. Press "1, 5, 0, 0" in order for 15:00 to appear in the display.
- c. Press Power Level , then press "5" to select 50% microwave power.
- d. Press **START** /+30Sec to start cooking. Buzzer sounds once. The remaining cooking time will display.

# OPERATION



## NOTE:

In the process of setting, if the  pad is pressed or if there is no operation within 1 minute, the oven will automatically return to display the clock.

## 5.ONE TOUCH START

- (1) Instant cooking at 100% power level and 1 to 6 minutes cooking time can be started by pressing number pads 1 to 6. Press  to increase the cooking time by 30 seconds with each press. The maximum cooking time is 99 minutes, 99 seconds.
- (2) Instant cooking at 100% power level and 30 seconds cooking time can be started by pressing . Each repeated press will increase cooking time by 30 seconds. The maximum cooking time is 99 minutes, 99 seconds.

## NOTE:

- Time can also be added in 30 second increments by pressing  during Microwave Cooking, Time Defrost and Multi-stage Cooking.
- Time cannot be added by pressing  during Weight Defrost and Kitchen Timer functions.

## 6.CUSTOM DEFROST FUNCTION

- (1) Press **Custom Defrost**, "dEF1" and "DEF." will appear in the display. Press the same pad repeatedly, "dEF2", "dEF3", "dEF1" will display in order.

LED display	dEF1	dEF2	dEF3
Food	Meat	Poultry	Fish

- (2) Press number pads to enter the weight to be defrosted.  
Input the weight range between 0.1 to 6.0 Lbs.  
If the weight input is not between 0.1 to 6.0 Lbs, the input will be invalid. The unit will not work until valid numbers are entered.
- (3) Press  to start defrosting and the cooking time remaining will be displayed. "DEF." indicator will flash.

**Note:** When half of the defrosting time passes, the oven will beep once to remind you to turn over the food. Open the door to pause operation. Turn over food, close door and press  to resume defrost cycle. If you do not open door to pause operation, the oven will continue the defrost cycle without interruption.

# OPERATION

---

## 7.1 LB DEFROST

- (1) Press **1lb Defrost** , "1.0", "DEF." and "Lbs" will appear in the display.
- (2) Press  to start defrosting, "Lbs" will disappear. "DEF." will flash, and the remaining defrost time will display.

## 8.SENSOR MENU ( Sensor Reheat, Frozen Pizza, Frozen Entrée, Potato, Rice, Veggie)

- 1) Press the pad for one of the Sensor Menu functions. An "SC-" number, "Auto" and "SENS." will appear in the display. Example: If "Rice" is pressed, "SC-5" will display.
- 2) Press  to start the sensor cooking process. Once the item has been sensed the remaining cooking time will display. The oven beeps 5 times when cooking is finished.

### Note:

- 1) For best sensor cooking results:
  - a. The room temperature cannot be over 95°F (35°C ).
  - b. The weight of food must be more than 4 Oz (110 g).
  - c. The oven cavity, glass tray and utensils must be dry.
- 2) During cooking:
  - a. The food can be covered, but the cover or lid must be vented with a hole to allow steam to escape.
  - b. Wait until the cooking time is displayed and starts to count down. Opening the door or press  before the cooking time is displayed will cause an error in the sensor cooking process.
  - c. Once the cooking time displays and starts counting down, you can open the door to mix or turn over food.

Example: Potato Sensor Pad

- 1) Press **Potato** pad once, "SC-4", "Auto" and "SENS." will appear in the display.
- 2) Press  to cook.

### Note:

- a. Puncture the surface of each potato several times with the times of a fork.
- b. Place up to 4 potatoes on the glass turntable. Keep at least 1 inch of space between each potato.

# OPERATION

## Example: Sensor Reheat Pad

- 1) After placing food into oven, press **Sensor Reheat** pad and "SC-1" will display.
- 2) Press  to cook. Oven beeps 5 times when cooking is finished.

### Note:

- 1) Food to be avoided in sensor reheating.
  - a. Bread and other dry food, such as biscuits or cake.
  - b. Raw or uncooked food.
  - c. Beverages and frozen food.
- 2) The food can be covered, but the cover or lid must be vented with a hole to allow steam to escape.
- 3) The food temperature must be at least 40°F (5°C) when placing it into the oven for Sensor Heat to work correctly.
- 4) Preparing foods for Sensor Reheat.

Casseroles - Add 2 to 3 tablespoons of liquid, covered with lid or vented plastic wrap. Stir when time appears in the display window.

Canned foods - Empty contents into casserole dish or serving bowl, and cover with vented lid or plastic wrap. After reheating, let food stand for a few minutes.

Plate of food - Arrange food on plate; top with butter, gravy, etc. Cover with vented lid or plastic wrap. After reheating, let food stand for a few minutes.

## Example: VeggieSensor Pad

- 1) Press **Veggie** once, "SC-6" will display, to cook fresh vegetable.  
Press **Veggie** 2 times, "SC-7" will display, to cook frozen vegetable.
- 2) Press  to cook. After the cooking time displays, food can be turned over. Oven beeps 5 times when cooking is finished.

### Sensor menu chart:

Menu button	Sensor Reheat	Frozen Pizza	Frozen Entrée	Potato	Rice	Veggie
Food	Sensor Reheat	Frozen Pizza	Frozen Entrée	Potato	Rice	Fresh/Frozen Vegetable
Food Code	SC-1	SC-2	SC-3	SC-4	SC-5	SC-6/SC-7
Weight/Portion	8~32 oz	6~12 oz	8~32 oz	1~4 potatoes 10 oz each	8.0 oz~16.0 oz	4~16 oz

# OPERATION

---

## 9. POPCORN

- a) Press **Popcorn** repeatedly until the number you wish appears in the display, "1.75", "3.0", "3.5" oz will display in order. And "Auto" and "Oz" will appear in the display.
- b) Press **START** 7/+30Sec. to cook. "Oz" disappears. "Auto" flashes. Oven beeps 5 times when cooking is finished.

## 10. CUSTOM COOK

- a) Press **Custom Cook**, "CC-1" and "Auto" will appear in the display.
- b) Press **Custom Cook** more times, "CC-2, CC-3, CC-4, CC-5" will display in order.
- c) After selecting CC setting, press a number pad to select the weight or portion of food item.
- d) Press **START** 7/+30Sec. to cook, "Auto" flashes in display. Oven beeps 5 times when cooking is finished.

## 11. SOFTEN/MELT

- a). Press **Soften/Melt**, "S-1" will display.
- b) Press **Soften/Melt** more times, "S-2, S-3, S-4, S-5, S-6, S-7" will display in order.
- c) After selecting SC function, press a number pad to select the weight or portion of food item.
- d) Press **START** 7/+30Sec. to cook, "Auto" flashes in display. Oven beeps 5 times when cooking is finished.

## 12. FAVORITE FUNCTION

- (1) Press **Favorite** to program and choose up to three cooking procedures. Each procedure will be indicated by 1, 2 or 3 in the display.
- (2) Press **Favorite** until your desired procedure number appears in the display. Press **START** 7/+30Sec. to begin it. A maximum of two cooking stages can be set for each procedure.
- (3) To program a procedure, follow the steps listed below. Example: Cook food at 80% Power Level for 3 minutes and 20 seconds; save as memory 2.
  - a. Press **Favorite** twice; screen displays 2.
  - b. Press **Cook Time** once, then press "3", "2" and "0" in order.
  - c. Press **Power Level** once, then press "8" for "PL8" to display.
  - d. Press **Favorite** to save the procedure. Oven beeps once.  
Or press **START** 7/+30Sec. directly to start cooking.
- e. To choose the procedure from the memory list, press **Favorite** twice. Screen will display "2". Press **START** 7/+30Sec. to run procedure.



# OPERATION

---

**Note:**The procedure will remain programmed until the oven is unplugged or there is a power failure. If either occurs, the procedure will have to be reprogrammed into the oven.

## Auto Menu Chart:

Menu Button	Food	Display	Weight/portion
Custom Cook	Custom Cook-Bacon	CC-1	2-6 SLICES
	Custom Cook-Frozen roll/Muffin-reheat	CC-2	1-6 PIECES
	Custom Cook-Beverage	CC-3	1-2 CUPS
	Custom Cook-Chicken Pieces	CC-4	0.5-2.0 Lbs
	Custom Cook-Oatmeal(with milk)	CC-5	20/40 Oz
Soften/Melt	Melt-Butter/Margarine	S-1	1-3 STICKS
	Melt-Chocolate	S-2	4/8 Oz
	Melt-Cheese	S-3	8/16 Oz
	Melt-Marshmallows	S-4	5/10 Oz
	Soften-Butter	S-5	1-3 STICKS
	Soften-Ice cream/Frozen juice	S-6	6/12/16 Oz
	Soften-Cream cheese	S-7	3/ 8 Oz

# OPERATION



---

## 13. MULTI-STAGE COOKING

At most 2 stages can be set for cooking. If one stage is Defrost, it will automatically set to be the first stage.

Note: Quick Touch Presets cannot be used in multi-stage cooking.

Example: 80% Power Level for 5 minutes followed by 60% Power Level for 10 minutes; saved as memory 3.

- a. Press **Favorite** 3 times; screen displays 3.
- b. Press **Cook Time** once, then press "5", "0" and "0" to set first stage cook time.
- c. Press **Power Level** once, then press "8" to choose 80% first stage cooking power.
- d. Press **Cook Time** again, then press "1", "0", "0" and "0" to set second stage cook time.
- e. Press **Power Level** again, then press "6" to choose 60% second stage cooking power.
- f. Press  to immediately start multi-stage cooking.
- g. To choose the procedure from the memory list, press **Favorite** three times. Screen will display "3"; press  to run procedure.

Note: If you do not want to save a particular multi-stage program as a procedure, do not press **Favorite** as the first step. Multi-stage cooking will begin the first time.

Press  after programming both stages.

## 14. INQUIRING FUNCTION

- (1) When oven is cooking, press **Clock** for the time of day to appear for three seconds in the display.
- (2) When oven is cooking, press **Power Level** pad for cooking power to appear for three seconds in the display.

## 15. LOCK FUNCTION

To lock the microwave so that it cannot be operated by children or other unintended users, press  pad for 3 seconds. You will hear a long beep.

If the clock has been set, the time of day and "Lock" will appear in the display.

Otherwise, only "Lock" will appear.

To Unlock, press  for three seconds, you will hear a long beep and "Lock" will disappear.

# OPERATION

---

## 16. TURN ON/OFF THE BUZZER SOUND



It is default that the buzzer sounds is open. In waiting state, long pressing on number 8 for 3 seconds, it sounds a long beep, turns off the sound.

When the sounds turn off, long pressing on 8 for 3 seconds, it sounds a long beep and the sound turn off. All the buttons has no beep when they are pressed, including the ending cooking sounds is turn off too.

Note: All models has mute function and energy-saved function.

This function can work under lock function too.

## 17. ENERGY SAVER MODE

- (1) In standby mode, press the "  " once (less than 3 seconds to avoid starting the child lock function )to enter the Energy Saver mode.
- (2) In child-locked mode, press the "  " once (less than 3 seconds) and release to enter the Energy Saver Mode.
- (3) Above operation is the only way to start the Energy Saver mode.
- (4) The Energy Saver mode works only if the door is closed.

## 18. COOKING END REMINDER FUNCTION

The oven will beep five times to alert the user that cooking time has ended. "End" will display.

The time of day will display by opening the door or pressing  pad.

## 19. OTHER SPECIFICATIONS

- (1) When setting cooking function, the function abbreviation appears in the display.
- (2) When oven is cooking or paused (door opened) in the midst of cooking time, the remaining cooking time appears in the display.

# MAINTENANCE

## TROUBLESHOOTING

Check your problem by using the chart below and try the solutions for each problem.

TROUBLE	Possible Cause	Possible Remedy
Oven will not start	<ul style="list-style-type: none"> <li>a. Electrical cord for oven is not plugged in.</li> <li>b. Door is open.</li> <li>c. Wrong operation is set.</li> </ul>	<ul style="list-style-type: none"> <li>a. Plug into the outlet.</li> <li>b. Close the door and try again.</li> <li>c. Check instructions</li> </ul>
Arcing or sparking	<ul style="list-style-type: none"> <li>a. Materials to be avoided in microwave oven were used.</li> <li>b. The oven is operated when empty.</li> <li>c. Spilled food remains in the cavity.</li> </ul>	<ul style="list-style-type: none"> <li>a. Use microwave-safe cookware only.</li> <li>b. Do not operate with oven empty.</li> <li>c. Clean cavity with wet towel.</li> </ul>
Unevenly cooked foods	<ul style="list-style-type: none"> <li>a. Materials to be avoided in microwave oven were used.</li> <li>b. Food is not defrosted completely.</li> <li>c. Cooking time, power level is not suitable.</li> <li>d. Food is not turned or stirred.</li> </ul>	<ul style="list-style-type: none"> <li>a. Use microwave-safe cookware only.</li> <li>b. Completely defrost food.</li> <li>c. Use correct cooking time, power level.</li> <li>d. Turn or stir food.</li> </ul>
Overcooked foods	<p>Cooking time, power level is not suitable.</p>	<p>Use correct cooking time, power level.</p>
Undercooked foods	<ul style="list-style-type: none"> <li>a. Materials to be avoided in microwave oven were used.</li> <li>b. Food is not defrosted completely.</li> <li>c. Oven ventilation ports are restricted.</li> <li>d. Cooking time, power level is not suitable.</li> </ul>	<ul style="list-style-type: none"> <li>a. Use microwave-safe cookware only.</li> <li>b. Completely defrost food.</li> <li>c. Check to see that oven ventilation ports are not restricted.</li> <li>d. Use correct cooking time, power level</li> </ul>
Improper defrosting	<ul style="list-style-type: none"> <li>a. Materials to be avoided in microwave oven were used.</li> <li>b. Cooking time, power level is not suitable.</li> <li>c. Food is not turned or stirred.</li> </ul>	<ul style="list-style-type: none"> <li>a. Use microwave-safe cookware only.</li> <li>b. Use correct cooking time, power level.</li> <li>c. Turn or stir food</li> </ul>
Sensor cooked foods not properly cooked	<ul style="list-style-type: none"> <li>a. Cover or lid on food not vented.</li> <li>b. Door opened before sensor-detected cooking time appears in display.</li> </ul>	<ul style="list-style-type: none"> <li>a. Cover or lid over food must contain vent hole for escaping steam.</li> <li>b. Do not open door to stir or turn food before sensor-detected cooking time appears in display.</li> </ul>

# ONE YEAR LIMITED WARRANTY

This product carries a warranty stating that it will be free from defects in material and workmanship for a period of one year from the date of purchase. This warranty is valid for the original retail purchaser from the date of initial retail purchase and is not transferable. Keep your original sales receipt.

## IMPORTANT:

1. This warranty does not cover damages resulting from accident, misuse or abuse, lack of reasonable care, the affixing of any attachments not provided with the product, loss of parts, or subjecting the appliance to any but the specified voltage. ( Read directions carefully. )
2. This warranty is void if this product is ever used for other than private household purposes.
3. This warranty is void if this product is ever used outside of United States.

If service is required during the warranty period, properly pack your unit. We recommend using the original carton and packing materials.

If additional assistance is needed, please contact customer assistance at:

customercare@us.toshiba-lifestyle.com

855-204-5313

Midea America Corp

5 Sylvan Way,

Parsippany, NJ 07054

**Midea America Corp.** expressly disclaims all responsibility for consequential damages or incidental losses caused by use of the appliance. Some states do not allow this exclusion or limitation of incidental or consequential losses so the foregoing disclaimer may not apply to you. This warranty gives you specific legal rights, and you may also have other rights which may vary from state to state.

The serial number can be found on the back cabinet. We suggest that you record the serial number of your unit in the space below for future reference

Model Number: \_\_\_\_\_

Serial Number: \_\_\_\_\_

## SAVE THIS FOR YOUR RECORDS

Made in China





# **TOSHIBA**

Customer Assistance: 855-204-5313  
Midea America Corp  
5 Sylvan Way, Parsippany, NJ 07054

PN.:16170000A67332