

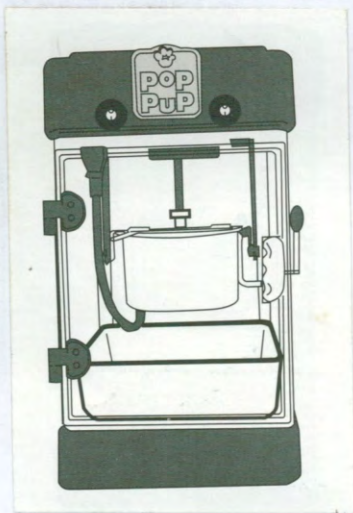

COMPANY

**PopPup Popper
Owner's Manual**



Congratulations! You have purchased one of our best selling popcorn poppers for your home.

We use only the finest grade material and workmanship when manufacturing our poppers. If for any reason our popper doesn't live up to these standards described, please write to us at service@greatnorthernpopcorn.com.

GreatNorthernPopcorn.com

A Complete Selection of Concession Supplies

©2009 DTX International All Rights Reserved

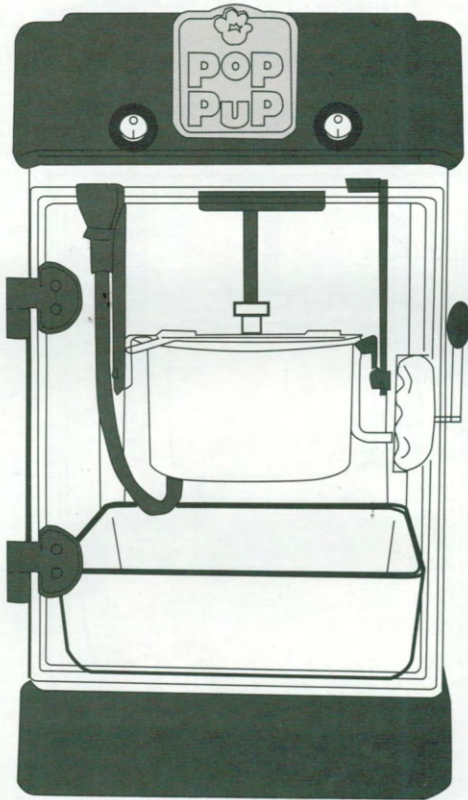

Copyright 2010 DTX International All Rights Reserved

IMPORTANT SAFEGUARDS

When using electrical appliances, basic safety precautions should always be followed including the following:

- **READ ALL INSTRUCTIONS BEFORE USING YOUR POPCORN MACHINE.**
 - Do not touch hot surfaces. *Always* use handles or knobs to operate.
 - To avoid any risk of electrical shock, do not immerse cord or plug in water.
 - Avoid operating this popper near children or adults with disabilities that might cause injury.
 - **Unplug main power cord from outlet while not in use and before cleaning.**
 - Allow hot parts to cool down before moving or cleaning.
 - Do not operate the appliance with a damaged cord or plug, or if the machine is malfunctioning or damaged. Send the unit to the nearest authorized service center for examination and repair. (ONLY technicians should open up the unit.)
 - Using any accessories or attachments not provided or recommended by the manufacturer may result in injury.
 - Do not pop kernels in a dry pot (without oil).
 - Do not immerse the kettle in water.
 - Pot surface are **HOT** and should **NOT** be touched during the popping process or just after use.
 - Allow the unit to cool, then unplug, clean and cover the unit and store in a dry, safe place while not in use.
 - Do not leave the power cord hanging over edge of table or counter or touch hot surfaces.
 - **DO NOT** place the unit on or near a hot gas or electric burner or in a heated oven.
 - Extreme caution must be used when moving any appliance containing hot oil or other hot liquids.
 - Turn ALL switches to "OFF" position before disconnecting power plug from the outlet.
 - Do not use outdoors.
 - Do not use appliance for anything other than the indicated usage.
 - Extreme caution must be used when unloading popcorn, always use oven mitts. Be careful that residual hot oil or water does not come into contact with skin, as burns may occur.
 - Always place the unit over a counter-top so that residual hot oil or water will not cause injury.
 - A popper that is plugged into an outlet should not be left unattended. Misuse of this product may cause burns.
 - This popper will not shut off automatically. To avoid overheating, add corn and oil before operating.
-
- **KEEP OUT OF REACH OF CHILDREN.**
 - **DO NOT CLEAN USING ANY ABRASIVE MATERIAL.**
 - **NEVER FORCE ANY PARTS OR BRACKETS INTO POSITION.**
 - **NO MACHINE OR KETTLE PARTS ARE INTENDED FOR THE DISHWASHER WITH THE EXCEPTION OF THE REMOVABLE PLASTIC POPCORN TRAY AND MEASURING CUPS OR SPOONS.**
 - **DO NOT OPEN THE DOOR DURING THE POPPING PROCESS.**

IMPORTANT SAFEGUARDS

SAVE THESE INSTRUCTIONS

FOR HOUSEHOLD USE ONLY

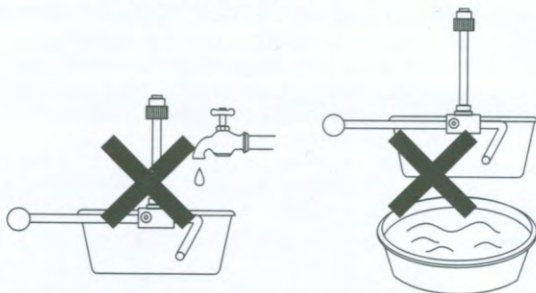

ELECTRICAL CORD

- A short power-supply cord is to be provided to reduce the risk resulting from becoming entangled in or tripping over a longer cord.
- Longer extension cords are available and may be used if care is exercised in their use.
- If a longer extension cord is used:

- The marked electrical rating of the cord or extension cord should be at least as great as the electrical rating of the appliance, and
- If the appliance is a grounded appliance, the extension cord should be a grounding 3-wire cord; and
- The longer cord should be arranged so that it does not drape over the counter-top or table top where it can be pulled on by children or tripped over unintentionally.

SPECIFICATIONS & PARTS

2.5oz PopPup Popper
Model No.: 6074 PopPup Popper
Voltage: 120V AC ~ 60Hz

- Door
- Measures
- Removable dishwasher-safe tray
- Kettle
- Housing

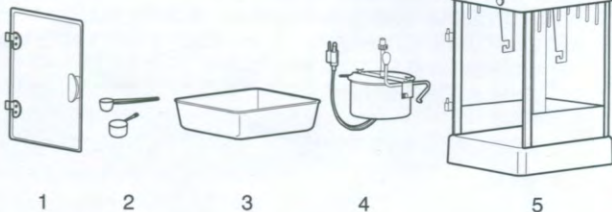

Copyright 2010 DTX International All Rights Reserved

ASSEMBLY INSTRUCTIONS

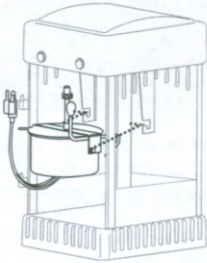

1. Hook the kettle onto the hangar of the main housing.

2. Insert the inside kettle plug into its socket located on the inside top of the housing.

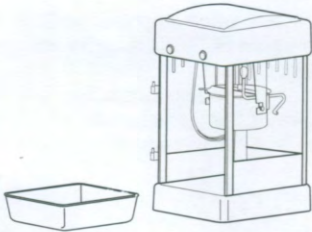
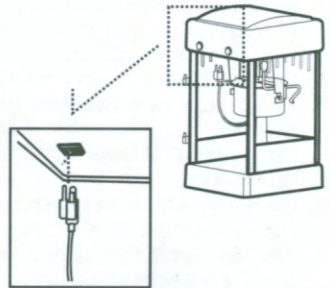

3. Place the removable tray into the housing.

4. Hang the door onto the hinges.

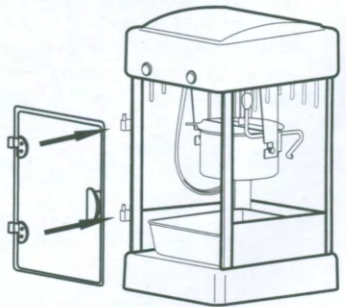

OPERATING PROCEDURES

Please Note: If you are using your popper for the first time, clean the interior of the glass surfaces and wipe the inside of your popper with a clean damp sponge before heat is applied. Please follow these procedures for the best operating results and long machine life.

1. Place the corn popper on a dry, level surface. Protect from rain and other weather elements. Do not install near pool or water. Plug the unit into a suitable grounded electrical outlet. (Please check the electrical specs. Be sure that your power source matches the rating label specified next to the power cord; 120V AC ~ 60Hz).
2. The unit has 2 function switches: Light and Pop.

Light: turns on the light inside the popper housing

Pop: controls power to the motor and kettle heater

3. Make sure that the kettle plug inside the housing is plugged into its housing outlet, then plug the power cord into your household electrical outlet.
4. Plug in the power cord to the popcorn maker.
5. Before adding popcorn or oil make sure that the kettle lid is up; open using the kettle lid tab.
6. Turn the Light and Pop switches to the ON position and allow the machine to preheat for 2-3 minutes.

Please Note: ENGAGING BOTH SWITCHES WILL TURN THE LIGHT, MOTOR AND KETTLE HEATER ON.

7. Once the machine has preheated, turn the Pop switch to the OFF position and add 1 Tablespoon of oil immediately followed by 1/3 cup popcorn (use scoop provided). Close lid immediately.
8. Turn Pop switch to the ON position. The stirrer will engage and the kettle will begin to heat and pop the popcorn.
CAUTION: When adding oil, corn, during the popping process, when emptying kettle or handling machine after popping, machine and kettle and kettle lid will be HOT. We recommend using oven mitts. Use extreme caution to avoid burns and keep children away!
9. Corn should begin to pop after approximately 2 minutes. When you no longer hear any popping, immediately turn the Pop switch to the OFF position and using the kettle handle, empty the remaining popcorn and kernels from the kettle into the removable tray with the rest of the popcorn (use mitts).

Note: Emptying the kettle immediately when popping is done will help to prevent burnt kernels and popcorn from forming in popper.

10. Keep Pop switch in OFF position if not preheating or popping. Keep unit unplugged when not in use.

CLEANING AND MAINTENANCE



CAUTION

- After popping cycle is complete, the popping pot will be very hot. Use extreme care when handling.
- Remember to turn the Pop switch to the OFF position after the finish of the pop cycle.
- Unplug unit when not in use. Use caution not to bump heat lamp bulb or kettle after popping.

- To maintain quality taste and popping conditions in your popper, we recommend that you thoroughly clean the heat pot after using 3 to 4 times or before prolonged periods of storage.
- Turn all switches to the OFF position and unplug the popper from the power source. Allow the popper to thoroughly cool before cleaning.
- Clean all surfaces with a damp cloth. Do not immerse the kettle or any other part of the popper in water.

Caution: Hot kettle! Handle with oven mitts. Keep children at a safe distance from popper during procedure. **DO NOT immerse the kettle in water.**

Order Now - For Immediate Delivery
GreatNorthernPopcorn.com



Any other servicing should be performed by an authorized service.

Copyright 2010 DTX International All Rights Reserved