

INSTRUCTION MANUAL

berger instruments **Level and Transit-Level**

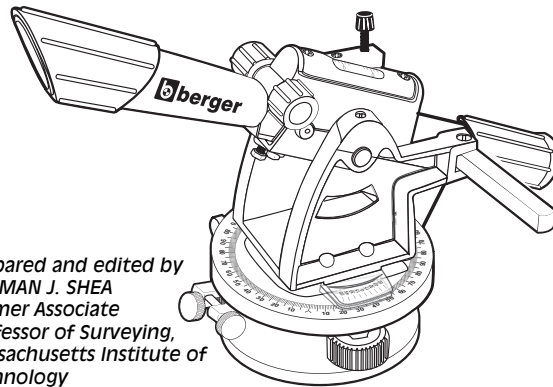

*Prepared and edited by
HERMAN J. SHEA
Former Associate
Professor of Surveying,
Massachusetts Institute of
Technology*

FOR CUSTOMER SERVICE,
PARTS & REPAIR
CALL
815-432-9200

The purpose of this manual is to furnish a basic understanding of your instrument and how it can be used to solve many common building and construction problems.

Your instrument is precision made and capable of numerous applications. Listed in the table of contents are a few representative building, engineering and farming problems.

CONTENTS

1. Setting up the Instrument on the Tripod	4
2. Leveling the Three Screw Instrument	4
3. Bubble Adjustments	5
4. Plate Bubble Adjustment	5
5. Preparing Telescope for Use	6
6. Leveling and Difference of Elevation	6
6.1 Leveling Rods	6
6.2 Inches and Decimal Portions of a Foot	6
6.3 To Measure a Difference in Elevation from One Set-up	7
6.4 To Measure a Difference in Elevation Requiring More Than One Set-up	8
6.5 Elevations or Grades	8
7. Measuring and Laying Out Horizontal Angles	9
7.1 Setting Up Over a Point with Plumb Bob	9
7.2 Measuring Horizontal Angles	9
8. Reading the Vernier	10
8.1 The Horizontal Vernier	10
8.2 The Vertical Vernier	11
9. Special Uses of Transit-Level Instruments	12
9.1 Setting Points in Line	12
9.2 Plumbing	12
10. Slopes and Rates of Grades	13
11. Practical Applications	14
11.1 Grade Line for a Sewer	14
11.2 Batter Boards for a Sewer	14
12. Stadia Distance Measuring	15
13. Care of Instrument	16
14. Warranty	17
15. Adjustment Points	18

IMPORTANT!

READ THIS BEFORE USING THE INSTRUMENT

This quality Berger instrument has been inspected twice for accuracy before leaving the factory. The instrument has also been given the best protection possible against damage during transportation. Even with these precautions, the instrument is subject to rough handling during shipment. To protect yourself against the possibility of using an instrument which is out of adjustment, we suggest that you have the instrument checked by a competent person before using it.

The following test can be performed to check the instrument's accuracy:

Set up the instrument in an area that is as level as possible and which is about 220 feet long. Place two matching level rods (or drive two pieces of strapping into the ground) about 200 feet apart with the faces toward each other. Position and level the instrument so that the distance from the instrument to each rod is the same (measure) (Fig. 1A).

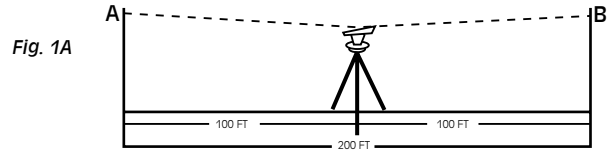
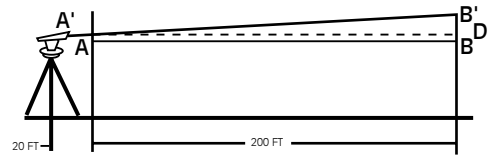

Fig. 1A



Take a reading on each rod with the instrument (or mark each piece of strapping where the crosshair is sighted). Note the difference and record them. Next, move the instrument to another point in line with the two level rods as shown (Fig. 2A). Level the instrument and take readings on the two level rods (or remark the two pieces of strapping with the new crosshair sightings). The differences should be the same ($A - A'$ should equal $B - B'$). The difference between $A - A'$ and $B - B'$ is the instrument error at 200 feet.

Correction of instrument error should be performed by a competent repair technician. The instrument should be rechecked periodically to assure continued accuracy.

1. SETTING UP THE INSTRUMENT ON THE TRIPOD

Your instrument is packed in a carrying case of modern design which affords maximum protection against weather, shock, and vibration. Note how the instrument is stored so it can be replaced in the case in the same position.

Before removing the instrument from its carrying case, set up your tripod in a stable position with the tripod legs tightened securely.

Instrument fastening screw
(under the tripod platform)

Fig. 1

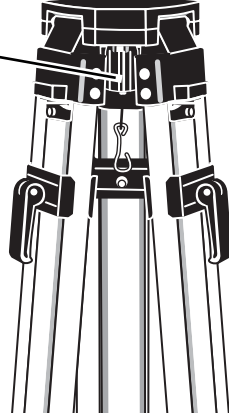

This instrument attaches to the tripod using a 5/8-11 instrument fastening screw. Place the instrument on the tripod and hold in place with one hand. Reach under the tripod head and grab the instrument fastening screw. Push the screw up into the hole in the base of the instrument and tighten until the instrument is secure. (See Fig 1.)

2. LEVELING THE THREE SCREW INSTRUMENT

Instruments utilizing three leveling screws are mounted on the tripod and leveled in the following manner:

Mount the instrument on the tripod. Lock the telescope in place with the lock lever and line up the telescope vial in position #1 as shown (Fig. 2). Then grasp screws A & B so that both thumbs are moving in opposite directions, either toward each other or away from each other. Note that the bubble moves in the same direction as your left thumb. Do not permit the screws to come completely out of their bushings.

Keep about half the length engaged. When the bubble is centered in position #1, turn the instrument and observe the vial in position #2. Now center the bubble in position #2 using only screw C.

Fig. 2

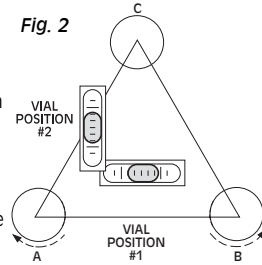

4 • Berger Instruments

Your Berger instrument should now be leveled up, but to be certain, double-check. Rotate the instrument 180° so the vial is reversed. If the bubble will not center when reversed, follow adjustment procedure outlined under "Bubble Adjustments."

NOTE: Bubble adjustments must be correct if proper results are to be obtained using the instrument.

3. BUBBLE ADJUSTMENTS

If the telescope bubble does not remain centered after having leveled the instrument, and reversed the telescope end for end (180°) (as described under the chapters entitled "Leveling the...Instrument") the need for adjustment is indicated. Use a screwdriver.

Fig. 3

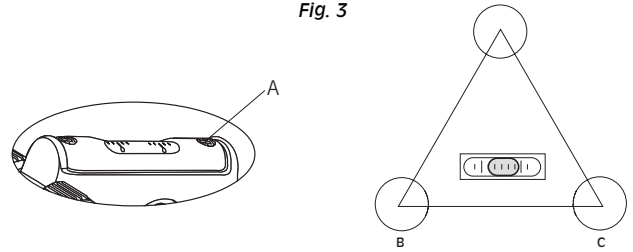

With an adjusting screw "A" facing to the right of the bubble and with telescope directly in line with two of the three leveling screws, note to which side the bubble is off. If to the left, loosen screw "B" very slightly to remove **ONE-HALF** the error. Remove the other half of the error with the two level screws in line with the telescope. If the bubble is still not exactly centered, repeat the procedure.

If bubble is off to the right, tighten screw "A". Otherwise, the procedure is identical (Fig. 3).

4. PLATE BUBBLE ADJUSTMENT

After completing the above adjustment, if your model also has a plate (bottom) bubble, check its adjustment. If off to the left, adjust by loosening right screw and tightening left screw removing ALL the error in this case by bringing bubble to center. If off to right, reverse the procedure. On models equipped with a capstan type screw, use pin and raise or lower screw as required to center bubble.

NOTE: Bubble will always run to the high side. Therefore, lower adjustment if bubble is toward adjusting side, or raise adjustment if bubble is away from adjusting side.

Berger Instruments • 5

5. PREPARING TELESCOPE FOR USE

The telescope magnifies the image many times, so the field of view is limited. Therefore, line up the telescope to your target by sighting along the telescope barrel much as you would aim a rifle. BE SURE THAT HORIZONTAL CLAMP SCREW HAS BEEN LOOSENED BEFORE TRYING TO ROTATE THE INSTRUMENT.

With the object in the field of view, gently tighten any loosened clamps. If the distant object appears indistinct, just rotate the focusing knob located on the top of the telescope until the object appears sharp.

If the telescope bubble is level, the horizontal crosshair will indicate a horizontal or level line of sight. Thus all objects in line with the horizontal crosshair are at the same elevation as the telescope. With a transit-level, if the telescope clamp (alongside the telescope) is loosened and the leveling latch opened, pointing the telescope up and down will indicate a vertical line. This action is used in "plumbing" flagpoles, columns, etc.

You will probably want to practice by repeating the steps described so that you will know the location of the various clamps and screws and be able to handle your instrument automatically.

6. LEVELING & DIFFERENCE OF ELEVATION

Much of your work will probably be concerned with relative heights of objects - the top of a foundation to be truly level or a sewer pipe to have a uniform pitch.

Your instrument, properly leveled, will enable you to determine and maintain a level line.

You will need a graduated rod which can be held in a vertical position. The 8 foot architects rod supplied in the outfit should provide a good length for most jobs and be easy to read.

6.1 Leveling Rods

Two types of level rods are available: **architects'** (graduated in feet, inches, and eighths of an inch), and **engineers'** (graduated in feet, tenths, and hundredths of a foot). Either type is available in 8 foot, 13 foot, or 16 foot lengths.

6.2. Inches and Decimal Portions of a Foot

Leveling and measurements of distances are often carried out in decimal portions of a foot (hundredths), whereas building plans are usually given to carpenters and masons in feet, inches, and fractions of an inch. To convert dimensions, remember that 8 hundredths of an inch (0.08 ft.) is equal, very nearly, to one inch. Also, 1/8 inch is very nearly equal to one hundredth of a foot (0.01 ft.). The table (Fig. 5), "Inches and Eighths to Decimals of a Foot", converts one system to the other.

6 • Berger Instruments

Inches and Eighths to Decimals of a Foot

in.	0	1/8	1/4	3/8	1/2	5/8	3/4	7/8
0	.00	.01	.02	.03	.04	.05	.06	.07
1	.08	.09	.10	.11	.12	.14	.15	.16
2	.17	.18	.19	.20	.21	.22	.23	.24
3	.25	.26	.27	.28	.29	.30	.31	.32
4	.33	.34	.35	.36	.38	.39	.40	.41
5	.42	.43	.44	.45	.46	.47	.48	.49
6	.50	.51	.52	.53	.54	.55	.56	.57
7	.58	.59	.60	.61	.62	.63	.64	.65
8	.67	.68	.69	.70	.71	.72	.73	.74
9	.75	.76	.77	.78	.79	.80	.81	.82
10	.83	.84	.85	.86	.88	.89	.90	.91
11	.92	.93	.94	.95	.96	.97	.98	.99

Examples: From Table: 2 feet, 7-1/8 inches = 2.59 feet.
From Table: 8.38 feet = 8 feet, 4-1/2 inches.

Fig. 5

6.3 To Measure a Difference in Elevation From One Set-up

To find the difference of elevation between two points which can be observed from one position, set up and level your instrument about midway between these points. Be sure that a leveling rod held on both opposite points can be read when your telescope is level. Each point should not be greater than 150 to 200 feet away from the instrument or you may have difficulty reading the rods. The height of the line of sight (horizontal crosshair) above or below each of the points is found by reading the rod.

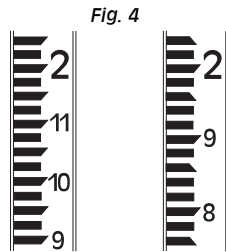

Fig. 4

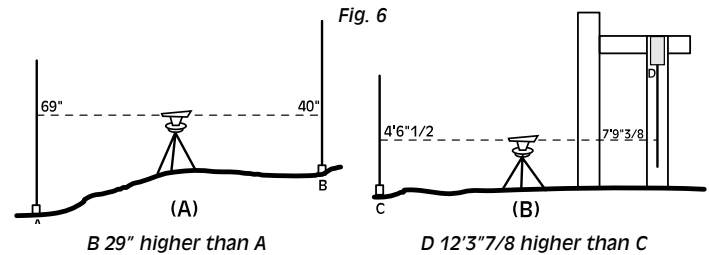

Fig. 6

A line of sight 69 inches above A and 40 inches above B is shown above (Fig 6A). Therefore, B is higher than A by 29 inches.

Suppose one of your points is below the line of sight and the other above (Fig. 6B), C is 4 feet 6-1/2 inches below the line of sight, and point D, the underside of a floor beam is 7 feet 9-3/8 inches above the line of sight (the latter reading having been obtained by holding the rod upside down with the foot of the rod against the beam). D is then higher than C by an amount equal to 4 feet 6-1/2 inches plus 7 feet 9-3/8 inches, or a total of 12 feet 3-7/8 inches.

6.4 To Measure the Difference in Elevation Requiring More Than One Set-up

If two points are either too far apart or at too great a difference of elevation to be observed from one set-up, the procedure shown below is recommended (Fig. 7). This example assumes that you want to find the difference in elevation between points A and D. To make the finding of this difference simple, use the convenient terms **plus (+) sight** and **minus (-) sight** and carry the readings at each set-up as shown.

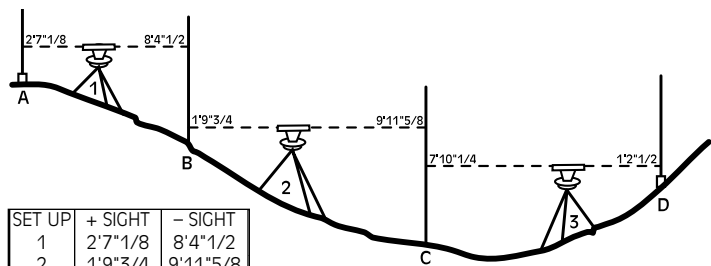

Fig. 7

NOTE: + Sight is rod reading from point to line of sight.
- Sight is rod reading from line of sight to point.

The difference of elevation between D and A is found by taking the difference between the sum of the plus sights and the sum of the minus sights. If the sum of the plus sights is larger, the final point is higher than the starting point. If the sum of the minus sights is larger, the final point is lower than the starting point.

6.5 Elevations or Grades

Many constructions, such as buildings and roadways, are required to be built at specified elevations or grades. To establish these grades, a point of elevation is necessary, often called a benchmark. Your benchmark should be a firm and definite point such as a bolt on a water hydrant, a spike in the root of a tree, a corner of a stone monument, or a chisel square on a ledge, and should be located outside the construction area. For a large job, several benchmarks in convenient locations are helpful. The grades may then be carried directly to the job by using the "difference in elevation" method described in Fig. 6 and Fig. 7. Keep a careful record of your observations in a notebook so that your values may be checked or used in later work.

8 • Berger Instruments

7. MEASURING AND LAYING OUT HORIZONTAL ANGLES

7.1 Setting Up Over a Point With Plumb Bob

To measure or lay out an angle, set the instrument over a point and level it up. Use the plumb bob with about six feet of string. Attach the plumb bob string to the hook under the instrument by means of a large loop fastened by a slipknot and adjust the plumb bob until it is clear of the ground point. By shifting the entire instrument, set the tripod (keeping tripod head as level as possible by estimation) so that the plumb bob appears to be over the ground point. Next, press the legs of the tripod into the ground and lower the plumb bob until its point is about one-quarter inch above the point on the ground. The final centering of the instrument can be made by loosening (about one-half turn) any two **adjacent** (not opposite) leveling screws and slowly shifting the instrument until the plumb bob is directly over the point on the ground. Then retighten the same two leveling screws you loosened and re-level the instrument.

7.2 Measuring Horizontal Angles

To measure horizontal angles such as EFG, (Fig. 8), center and level your instrument over point F in accordance with previous instructions.

Loosen horizontal clamp screw (attached to circle plate); rotate the instrument until point E is nearly in line with the vertical crosshair. Tighten clamp screw. Turn tangent screw until vertical crosshair is on point E. By hand set the horizontal circle to read zero (on some instruments, rotate the circle; on other instruments, set to zero with movable index). Now, loosen horizontal clamp (**do not touch circle or index**) and swing the telescope toward point G until the vertical crosshair is exactly on point G. The horizontal index pointer will have rotated about the horizontal circle by an amount equal to the angle EFG. The horizontal index and horizontal circle are shown (Fig. 10) after measuring a clockwise horizontal angle of 62°. If your instrument is furnished with a vernier instead of an index pointer, you will be able to read the angle closer than a single degree. The use of a vernier is explained later in this manual.

Fig. 8

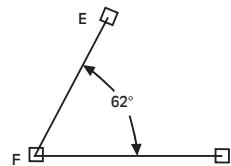
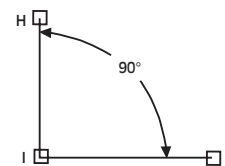

Fig. 9



In layout work, it is frequently necessary to set off an angle, usually 90°. Assume that the 90° angle HJ is to be laid off and points H and I are shown (Fig. 9). Therefore, J is the point you are to set.

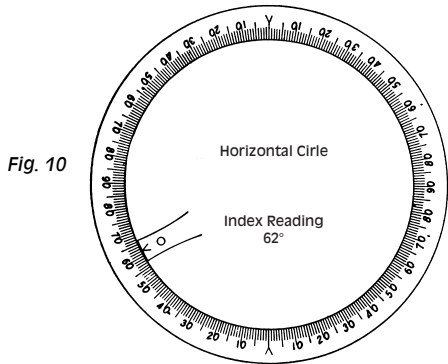

Fig. 10

As described in the chapter "Measuring Horizontal Angles", center and level your instrument over point I. Sight the telescope on point H and set the horizontal circle to read 0°. Loosen the horizontal clamp and rotate the telescope until the index pointer is very close to 90°. Tighten the horizontal clamp and turn the horizontal tangent screw until the index reads exactly 90°. The line of sight (vertical crosshair) will indicate point J and all you have to do is to set J along the line of sight by taping the required distance from I.

8. READING THE VERNIER

8.1 The Horizontal Vernier

Reading a vernier is a simple process as you will see from the following:

Your vernier is actually a double vernier, that is, two verniers in one. This makes it possible to read any angle turned by the telescope, whether to the right or to the left. For example, consider that you have turned an angle to the left (counterclockwise) after first having set the circle to read 0° (Fig. 11).

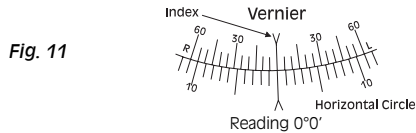

Fig. 11

Initial Setting of Horizontal Circle and Vernier

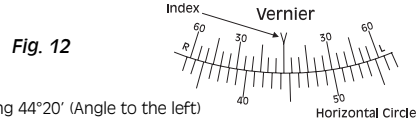

Fig. 12

Reading 44° 20' (Angle to the left)

Horizontal Circle

This is what your vernier looks like after having turned the angle (Fig. 12). Now, let's read the angle. Remember, we have turned to the left, so we are going to use the side of the vernier between the vernier index "V" and the letter "L".

NOTE: Do not be confused that the positions of "L" and "R" are reversed.

Observe in this case that the vernier index has passed the 44 degree line on the circle but has not gone as far as the 45 degree line. Right away, we know that the angle we have turned is greater than 44 degrees but not much greater than 44 degrees.

In the example we have chosen, we must add to 44 degrees the reading obtained from one of the vernier lines. Which vernier line? You will see that the fourth line from the vernier index is lined up with one of the lines on the circle (Fig. 13). This is the secret of the vernier. Only one line at a time can be lined up. Since in this case it is the fourth line from the index, we will add 20 minutes to the 44 degree reading (4 times 5 minutes equals 20 minutes). Therefore, our exact reading is 44 degrees 20 minutes (44° 20').

Other instruments have a vernier reading to 15 minutes (1/4 degree) and will look like the illustration below:

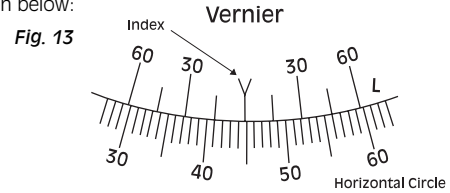

Fig. 13

Whether reading this vernier or the one shown on page 10, the principle is the same. The only difference is that each line on the vernier represents 15 minutes (1/4 degree) instead of 5 minutes.

Notice in the above illustration that the index has passed the 44 degree line but has not gone as far as the 45 degree line. In this case the third vernier line from the index is lined up with one of the lines on the circle. Since each vernier line represents 15 minutes, add 45 minutes to the 44 degree reading (3 times 15 minutes equals 45 minutes). Therefore, our exact reading is 44 degrees, 45 minutes (44° 45').

8.2 THE VERTICAL VERNIER

In reading the vertical vernier (if instrument is so equipped), the principle is exactly the same as the horizontal vernier. Note, however, that the vernier is below (or outside) the circle portion rather than inside as in the case of the horizontal. One other minor difference is that you will read angles up or down rather than left or right.

Here again we have a double vernier. The right hand side reads angles of elevation (up) and the left hand side reads angles of declination (down). These are the only differences between the horizontal and vertical verniers.

9. SPECIAL USES OF TRANSIT-LEVEL INSTRUMENTS

In the following three sections, two special operations are illustrated which can be performed with instruments of the **transit-level type** but cannot be performed with a dumpy level. When leveling lock is engaged, it converts the transit-level to a level, so all other functions described in this manual can be performed.

9.1 Setting Points in Line

Points A and B are two points which are on a line such as a property boundary (Fig. 14). When erecting a fence, additional points between A and B and also on the other side of B from A may be needed. Center and level your instrument over point A; sight on point B. Bring vertical hair exactly on point B by means of the horizontal clamp and tangent screw. A pencil held vertically at B is useful to show this point. Keeping horizontal clamp tightened, depress the telescope to set points between A and B on line.

Fig. 14

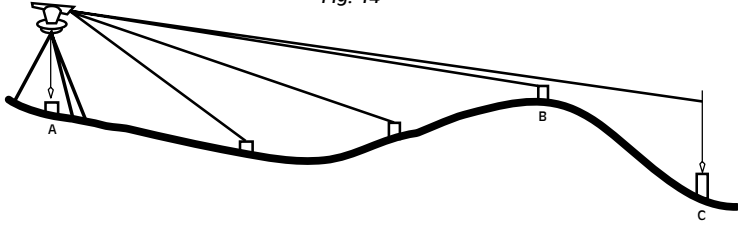

To Continue line beyond C, set Transit-Level over B, sight C, and continue process

If the top of a stake cannot be seen, when you come to set point C, sight with the aid of a plumb bob: first, to find where to drive the stake, and secondly, to note the point on the top of the stake.

If it is necessary to continue this line beyond point C, center and level your instrument over point B, sight point C and continue this procedure.

9.2 Plumbing

Instruments of the transit-level type can be used to advantage in plumbing such objects as building walls, columns and flagpoles. Set and level your instrument at a point which is about as far away from the object as the object is tall. Select a point at the base of the object which is to be plumbed; sight your telescope on this point and set the intersection of cross wires directly on it. By raising your telescope, you will find, through use of the line of sight and the crosshairs, whether or not the object is plumb. If it is plumb, the object will appear not to move away from the crosshair intersection. To completely check the plumb of the object, set the instrument at a position which is at an angle of 90° from the first position of the instrument and repeat the procedure. A corner post of a wood frame building is shown (Fig. 15) being plumbed.

Fig. 15

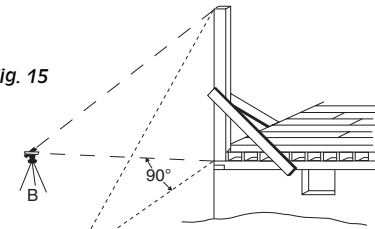

PROCEDURE:

At A, sight outside edge of corner post at the base. Raise line of sight to top of post. Bring outside edge to line of sight. Nail brace facing instrument. Repeat process with instrument at B.

To Plum a Vertical Column

10. SLOPES AND RATES OF GRADES

Fig. 16

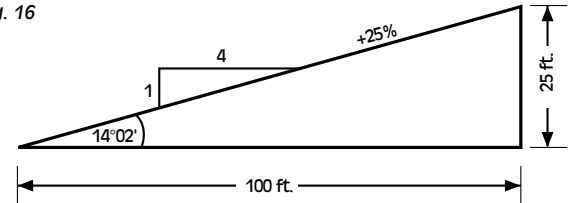

Definitions of Grade and Slopes

Several methods of defining slopes are shown above (Fig. 16).

1. Horizontal distance to rise (or fall) in vertical; thus the grade is 4 to 1, or, more completely, 4 **horizontal** to 1 **vertical**.
2. Rise or fall for each 100 feet horizontal. The slope, if extended for 100 feet horizontally would rise 25 feet. This is referred to as a 25% slope.
3. Rise or fall for each one foot horizontal. Again, this would be designated as 0.25 foot per foot, or three inches per foot.
4. Angle of slope is 14 degrees, 2 minutes ($14^\circ 2'$).

11. PRACTICAL APPLICATIONS

11.1. Grade Line for a Sewer

Steps to find the slope necessary for a household sewer connection are shown below (Fig. 17). Notice that the invert or flow-line of the pipe is used in each instance. The invert is the bottom of the pipe and this line is the reference from which grades are commonly given.

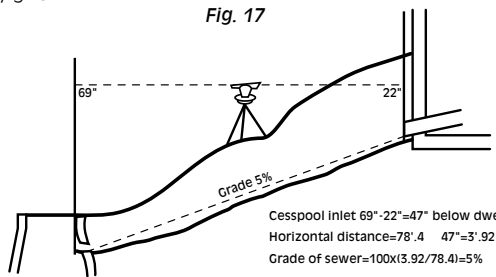

11.2. Batter Boards for a Sewer

Sewers are normally placed at some depth below the surface of the ground, so batter boards are placed somewhat higher above the invert grade. A typical layout for sewer batter boards is shown below (Fig. 18). The vertical strip nailed to the horizontal board is set with one edge along the line of the sewer. A nail is placed in this vertical strip at an even number of feet above the invert. By stretching a taut line between these nails, the sewer line is easily referenced. A board notched say 8 feet from its bottom is used to set the pipe.

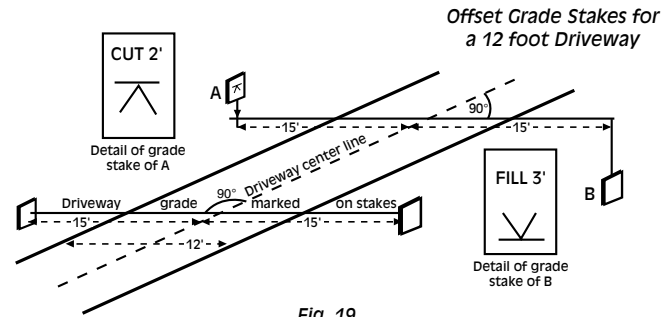
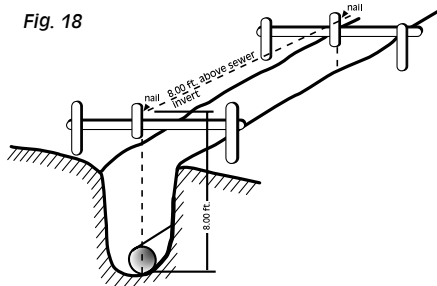

12. STADIA DISTANCE MEASURING

Distance measurement can be done using the stadia hairs of the reticle.

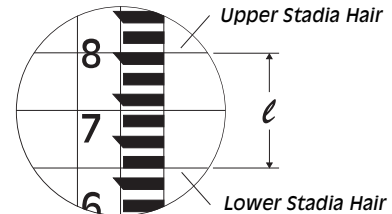

Read the length " l " of a level rod shown between the stadia hairs. The distance to the target is 100 multiplied by l . The distance between point A and point B is L.

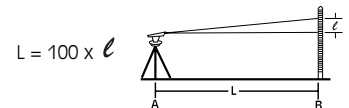

On a rod showing inches & eighths, you must convert the inches & eighths to the decimal form of a foot to get a correct reading. This is done by taking the partial foot reading, say 7 1/8 inches, and converting by dividing by 12.

$$l = 7.125 / 12 = .59 \text{ FT.}$$

$$L = .59 \times 100 = 59 \text{ FT.}$$

If l were 1' 7 1/8" then l would equal 1.59 ft. & L = 159 ft.

13. CARE OF INSTRUMENT

It will pay dividends to treat your instrument well.

1. Avoid possibility of accident. When near moving equipment, never leave instrument unattended. Always spread tripod legs to insure a stable setup. If the instrument is set up on pavement or flooring, protect the tripod legs by making small holes or depressions for the tripod points to set into. Another method is to insert screw eyes at the lower inside of the tripod legs and run cord, wire or light chain between the three screw eyes.
2. When going through buildings or any close quarters, hold the tripod under your arm with the instrument in front of you.
3. Store your instrument in its case when not in use.
4. Avoid jolting your instrument. When transporting the instrument by automobile or truck, see that the instrument is in its case and properly protected. If you have to carry the instrument in a vehicle without the case, take the instrument off the tripod and carry it in your lap.
5. When working in dusty locations, some dirt will collect on the lenses. Never scrub the dirt off, but rather dust it off with a clean soft rag.
6. Dust and dirt will collect on the leveling and tangent screws eventually causing their operation to become sticky. Brush the screw threads with a child's toothbrush dipped in solvent (preferably nonflammable) and work it into the threads.
7. Never overtighten leveling screws, adjusting screws or clamp screws. No instrument will withstand mistreatment.
8. If your instrument bubble(s) require(s) adjustment, see "Bubble Adjustment" section before proceeding.
9. Have your instrument checked periodically by a qualified service station or by the factory.

14. WARRANTY

CST/berger (Seller) warrants the equipment of its manufacture to be free of defects in workmanship and material for a period of one year from date of purchase. If within such one year period the original purchaser (Buyer) notifies Seller, in writing, that the equipment purchased is not as warranted, and provides a bill of sale, receipt, or other proof as to date of purchase, Seller will, at Seller's option, adjust, repair or replace the whole or any part of the equipment which seller finds to be defective, provided:

- A. The equipment is returned transportation prepaid to Seller or its designated warranty service center.
- B. The equipment is in original condition excepting only ordinary wear resulting from normal usage.
- C. The Seller has received prompt written notification and substantiation that the equipment has been stored, installed, operated and maintained in accordance with the recommendation of the manufacturer and has not been subjected to service by other than Seller or an authorized service center.

Warranty service does not include cleaning, oiling, or adjustment of the equipment unless required as a result of a workmanship or material defect in the equipment. If, upon examination of the equipment, the Seller determines that such cleaning, oiling, or adjusting is required other than by reason of the warranty claim, Seller shall notify Buyer of the charges for same and after authorization is received from Buyer, Seller shall perform such additional service(s) on behalf of the Buyer at its standard charges then in effect and the Buyer shall be responsible for the payment of such charges in addition to the other charges and expenses referred to above. In all cases, Buyer is responsible for transportation charges for return of goods from Seller to Buyer.

Seller's liability to Buyer (whether in contract or in tort) arising hereunder or as a result of any claimed defect or for any other cause, is hereby expressly limited to correcting the equipment upon the terms and conditions stated above. All liability hereunder shall terminate upon expiration of the applicable warranty period. In no event shall Seller be liable for any loss, expense, or damages direct, indirect, consequential, or special arising from the sale or use of the equipment delivered hereunder.

THE FOREGOING WARRANTY STATES SELLER'S FULL LIABILITY IN CONNECTION WITH THE PURCHASE OF THIS EQUIPMENT, ACCESSORIES, AND PARTS AND IS IN LIEU OF AND SUPERSEDES ANY AND ALL OTHER WARRANTIES AND REPRESENTATIONS, IF ANY, EXPRESS OR IMPLIED, INCLUDING MERCHANTABILITY OR FITNESS FOR PURPOSE, AND SHALL BE VOID IF REPAIRS HAVE BEEN MADE OR ATTEMPTED BY PERSONS OTHER THAN SELLER'S FACTORY PERSONNEL OR DESIGNATED AUTHORIZED SERVICE CENTER. THIS WARRANTY IS NOT TRANSFERABLE.

15. ADJUSTMENT POINTS

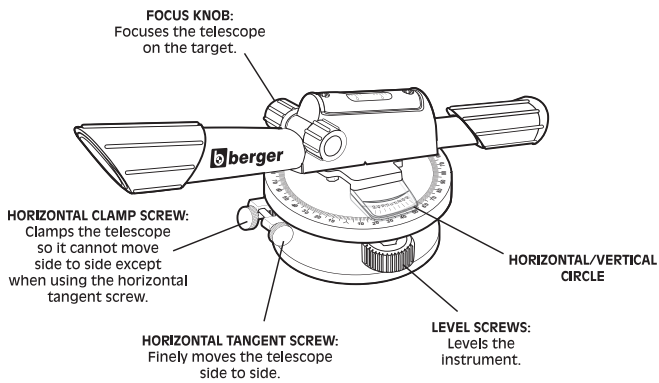
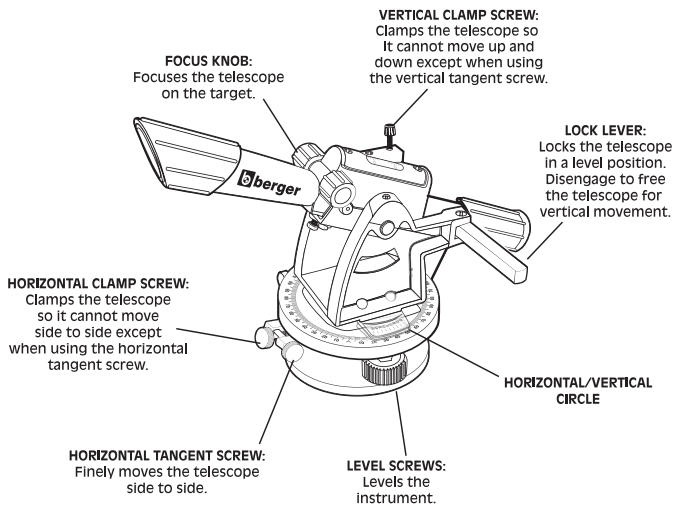

CST/berger

a division of The Stanley Works

255 W. Fleming Street
Watseka, IL 60370 USA
(815) 432-9200
Toll Free US: (800) 435-1859
FAX: (815) 432-2417

www.cstsurvey.com
sales@cstsurvey.com

Chicago Steel Tape

Berger Instruments

Magna-Trak®

LaserMark®

Tru-Lock™

Z94-TRANSLEV (1018)