

ASTROAI USER MANUAL

AUTO RANGING DIGITAL CLAMP METER

Thank you for purchasing the Auto Ranging Digital Clamp Meter from AstroAI. The AstroAI Auto Ranging Digital Clamp Meter is designed to be safely and accurately used by professionals in a commercial setting or weekend DIYer's that need a little more utility from their standard digital multimeter. This manual provides all safety information, operation instruction, specifications, and maintenance for the meter. The instrument performs AC/DC Voltage, AC Current, Temperature, Resistance, Audible Continuity, Diode, Frequency, Capacitance, and Duty Cycle. Thank you again for choosing AstroAI, if you have any questions or concerns regarding your product, please contact us at [**support@astroai.com**](mailto:support@astroai.com).

NOTE: Fully read and understand this manual before using this Digital Multimeter.

This manual provides all safety information, operation instruction, specifications, and maintenance for the meter. This Digital Clamp Meter has been designed according to EN61010-1 oncoming electronic measuring instruments with an overvoltage category (CAT III 600V CAT II 1000V) and Pollution degree 2.

WARNING: To avoid possible electric shock or personal injury, and to avoid possible damage to the Meter or to the equipment being tested, adhere to the following rules:









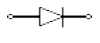

- Before using the Meter, inspect the exterior casing. Do not use the Meter if it is damaged or if all or part of the exterior casing is removed. Look for cracks or missing plastic. Pay special attention to the insulation around the connectors.
- Inspect the test leads for damaged insulation or exposed metal. Check the test leads for continuity.
- Do not apply more than the rated voltage, as marked on the Meter, between the terminals or between any terminal and grounding.
- The manual rotary switch should be placed in the correct position before measurement and should NOT be moved during measurement to prevent damage to the Meter.
- When the Meter is working at an effective voltage over 60V in DC or 30V rms in AC, special care should be taken because there is a danger of electric shock.
- Use the proper terminals, function, and range for your measurements.
- Do not use or store the Meter in a high-temperature environment, do not expose to high levels of humidity, or near strong magnetic fields. The performance of the Meter may deteriorate after dampening.
- When using the test leads, keep your fingers behind the finger guards.
- Disconnect circuit power and discharge all high-voltage capacitors before testing resistance, continuity, or diodes.
- Replace the battery as soon as the battery indicator appears. With a low battery, the Meter might produce false readings that can lead to electric shock and personal injury.

- Remove the connection between the testing leads and the circuit being tested, and turn the Meter power off before opening the Meter case.
- When servicing the Meter, use only the same model number or identical electrical specifications replacement parts.
- The internal circuit of the Meter shall not be altered at will to avoid damage of the Meter and any accident.
- Clean using a soft cloth and mild detergent for the surface of the Meter. Do not use abrasive materials or solvents to prevent the surface of the Meter from corrosion and damage.
- Turn the Meter off when not in use and take out the battery when it is not going to be used for an extended period of time. Regularly check the battery as it may leak when it has not been used for some time. Replace the battery as soon as leaking appears. A leaking battery will damage the Meter.

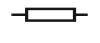
GENERAL INFORMATION

Display	LCD, 6000 Counts updated 2/sec
LCD Size	30*49mm
Polarity Indication	"-" displayed automatically
Over-Range Indication	"OL" displayed
Range Select	 displayed
True-RMS	ACV ACA measurement
Operating Temperature	32°F~104°F (0°C~40°C), less than 80% Relative Humidity
Storage Temperature	14°F~122°F (-10°C~50°C), less than 85% Relative Humidity
Battery Type	9V NEOA 1604, 6F22 equivalent
Dimensions	245 x 66 x 45mm
Clamp Jaw Opening	42mm Maximum
Weight	334g

ELECTRICAL SYMBOLS

	AC (Alternating Current)		Low Battery
	DC (Direct Current)		Diode
	AC and DC		Fuse
	Earth Ground		Continuity Test
	Double Insulated		Warning
AUTO	Auto Range		Dangerous Voltage may be present
CE	Complies with EU directives		

MULTIMETER DIAGRAM

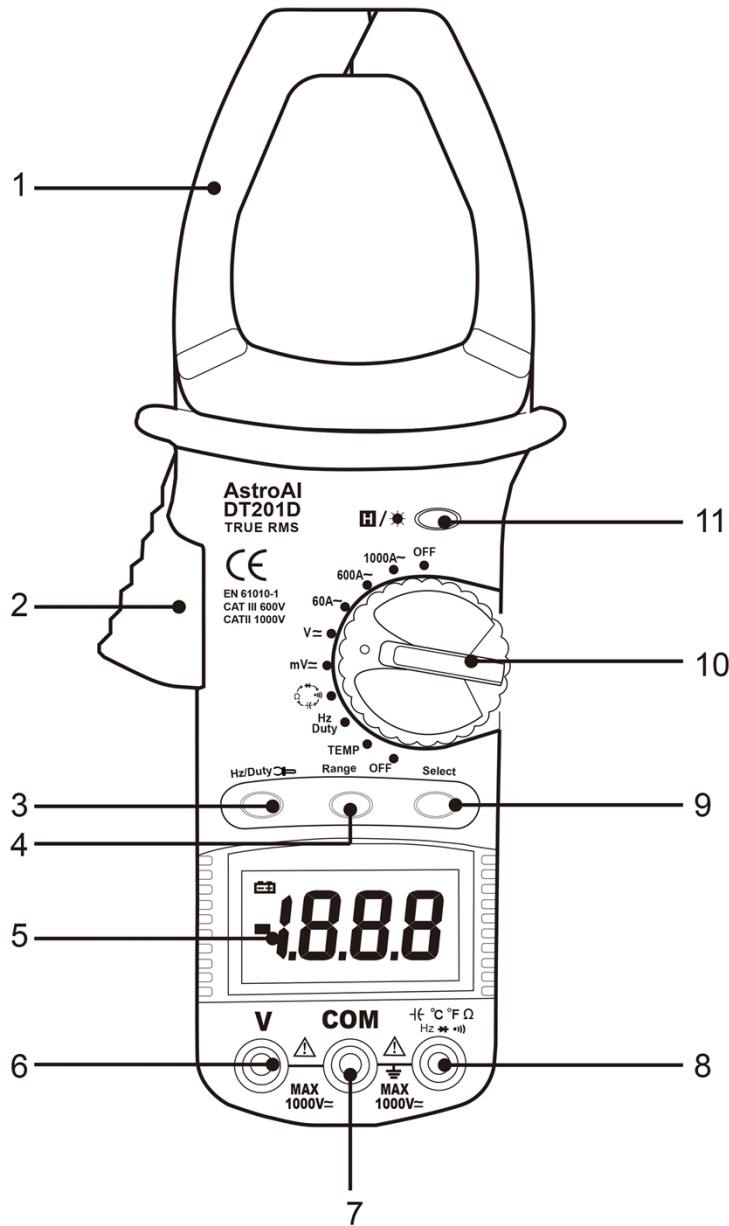

1. Transformer Jaws:
Picks up AC Current flowing through the conductor.
2. Trigger
Press to open the transformer jaws, when the trigger is not pressed, the jaws will automatically close.
3. Hz/Duty Button
Push this button when in the Hz position to select Hz or Duty Cycle measurement. When selecting the AC Current function, this button can measure frequency.
4. Range Button

AC/DC voltage, AC current, and Resistance can all be selected manually or automatically by pushing the Range button. Use this button to select the desired range.

5. Display
3 5/6 digit LCD, with a maximum reading of 5999.
6. "⌚ °C °F Ω" Input Connect
High input for all except voltage, measurement will accept banana plugs.
7. COM Input Jack
Low input for all voltage, resistance, and continuity measurements. Will accept banana plugs.
8. "Ω" Range
Resistance, continuity, capacitance, diode. Push the select button to choose needed ranges.
9. Select Button
Push this button to select Ω, ⌚, °C, °F or ⌚ measuring function when the function switch when the function switch is set at Ω, ⌚, °C, °F or ⌚ range.
10. Function Switch
Use this switch to select the desired function and range.
11. Hold Button
When this button is pushed, the LCD will show the last reading, and the "H" symbol to indicate that the data is being held. To activate the backlight, hold this button for three seconds. The backlight has a preprogrammed auto-off to save energy.

LCD SCREEN DIAGRAM

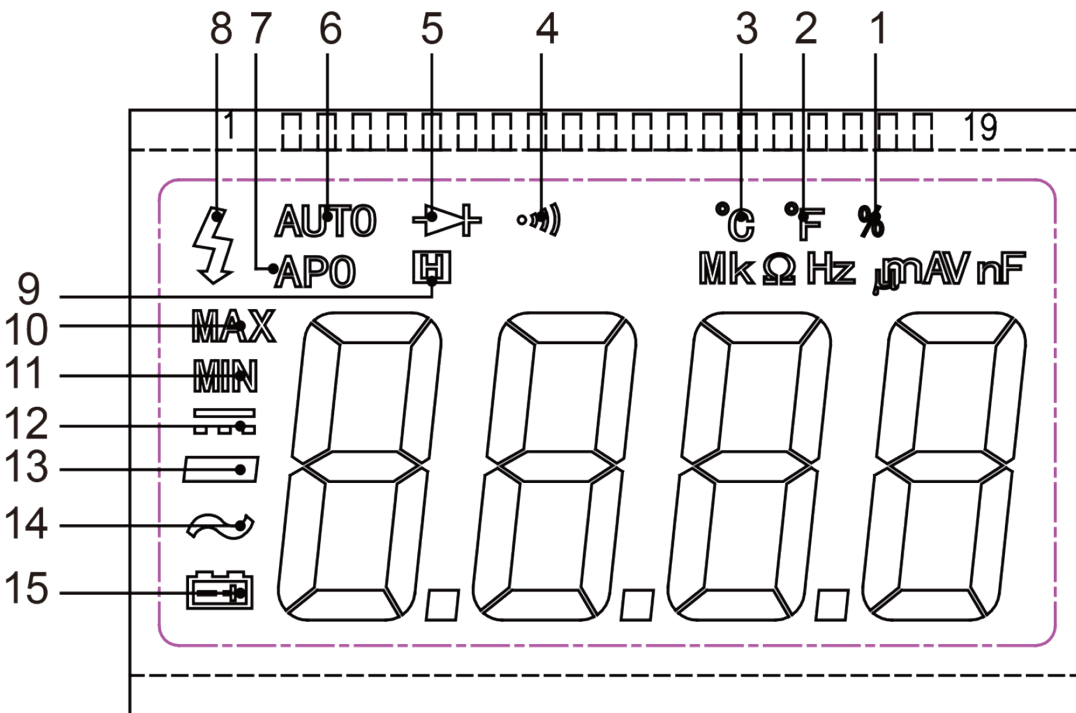

1. Duty Cycle is selected
2. Fahrenheit temperature test is selected
3. Celsius degree test is selected
4. Continuity test is selected
5. Diode test is selected
6. Autorange mode is selected
7. Automatic power-off mode is selected
8. High voltage warning symbol
9. Data Hold is enabled
10. MAX - Maximum reading is being displayed
11. MIN - Minimum reading is being displayed
12. DC
13. Negative sign
14. AC
15. Low Battery and replaced immediately

SPECIFICATIONS

Accuracy is guaranteed for 1 year when used and stored in 73°F±9°F and less than 80% RH.

DC VOLTAGE (Auto ranging)

Range	Resolution	Accuracy
600mV	0.1mV	±(0.8% of rdg + 5dgts)
6V	1mV	±(0.8% of rdg + 3dgts)
60V	10mV	
600V	100mV	
1000V	1V	±(1.0% of rdg + 5dgts)

Input Impedance: 10MΩ

Overload Protection:

600V AC RMS CAT III, 1000V AC RMS CAT II

Max. Input voltage:

600V AC RMS CAT III, 1000V AC RMS CAT II

AC CURRENT (Auto ranging)

Range	Resolution	Accuracy
60A	10mA	±(2.5% of rdg + 10dgts)
600A	100mA	
1000A	1A	

Measuring voltage drop: 200mV
show True-RMS value

AC VOLTAGE (Auto ranging)

Range	Resolution	Accuracy
600mV	0.1mV	±(1.2% of rdg + 8dgts)
6V	1mV	±(1.2% of rdg + 6dgts)
60V	10mV	
600V	100mV	
750V	1V	±(1.2% of rdg + 8dgts)

Input Impedance: 10MΩ

Input Impedance: 10MΩ

Overload Protection: 600V AC RMS CAT III, 1000V AC RMS CAT II

Max. Input voltage: 600V AC RMS CAT III, 1000V AC RMS CAT II

show True-RMS value

TEMPERATURE

Range	Resolution	Accuracy
-40 ~ 1370°C	1°C	-40°C~150°C:±(1% + 4)
		150°C~1370°C:±(2% + 3)
-40 ~ 2000°F	1°F	-40°F~302°F:±(5% + 4)
		302°F~2000°F:±(2.5% + 4)

Overload Protection: 250V DC/AC rms



RESISTANCE (Auto Ranging)

Range	Resolution	Accuracy
600Ω	0.1Ω	±(1.5% of rdg + 5dgt)
6KΩ	1Ω	
60KΩ	10Ω	
600KΩ	100Ω	
6MΩ	1KΩ	
60MΩ	10KΩ	

Open Voltage: about 0.25V

Overload Protection: 250V DC/AC RMS

DIODE AND CONTINUITY

Range	Introduction	Remark
	The approximate forward voltage drop will be displayed	Open circuit voltage: about 1.5V
	The built-in buzzer will sound if the resistance is less than about 30Ω.	Open circuit voltage: about 0.5V

Overload Protection: 250V DC/AC RMS

For continuity test: When the resistance is between 30Ω and 100Ω, the buzzer may sound or may not sound. When the resistance is more than 100Ω, the buzzer won't sound.

FREQUENCY (Auto Ranging)

Range	Accuracy
0 ~ 60MHz	±(1.0% of rdg + 5dgt)

FREQUENCY (Through clamp)

Range	Accuracy
50 ~ 1KHz	±(1.5% of rdg + 5dgt)

CAPACITANCE (Auto Ranging)

Range	Accuracy
60nF/600nF/6uF 60uF/400uF/20mF (10sec)	±(8.0% of rdg + 5dgt)

DUTY CYCLE

Range	Resolution	Accuracy
0.01%~99.9%	0.01%	±1%

OPERATION INSTRUCTIONS

Measuring Voltage

1. Connect the Black test lead to the COM Jack and the Red test lead to the V Jack.
2. Set the function switch to $V\approx$ or $MV\approx$ range.
3. Connect the test leads to the source or load to be measured.
4. Read the LCD display for the polarity of the Red test lead. The result will be a DC measurement.

NOTE:

- a. When measuring in a small range (E.G. mV), the meter may display an unstable reading when the test leads have not been connected to the load to be measured. It is normal and will not affect the measurements.
- b. To avoid damage to the meter, do not measure a voltage which exceeds 600V for DC Voltage or 600V for AC Voltage under CAT III conditions and 1000V for DC Voltage and 750V for AC Voltage under CATII conditions.

Measuring Current

1. Set the function switch to the 60A 600A 1000A range.
2. Press the trigger to open the transformer jaws and clamp one conductor only.
3. The result displayed will be AC Current.

Measuring Resistance

1. Connect the Black test lead to the COM Jack and the Red test lead to the “ $\text{Hz } \text{ } ^\circ\text{C } \text{ } ^\circ\text{F } \Omega$ ” Jack.
2. Set the function switch to “” range.
3. If desired, press the Range Button to manually select the measurement.
4. Press the Select Button to select the resistance measurement mode. The symbol “MΩ” will appear as an indicator on the screen.
5. Connect the test leads to the load being measured.
6. Read the results on the display.

NOTE:

- a. For resistance measurements $>1\text{M}\Omega$, the meter may take a few seconds to stabilize the reading. This is normal for high-resistance measurements.
- b. When the input is not connected, (E.G. the circuit is open) the symbol “OL” will be displayed as an over range indicator.
- c. Before measuring in-circuit resistance, be sure that the circuit being tested has all power removed and all capacitors are fully discharged.

Continuity Test

1. Connect the Black test lead to the COM Jack and the Red test lead to the “ $\text{Hz } \text{ } ^\circ\text{C } \text{ } ^\circ\text{F } \Omega$ ” Jack.

2. Set the function switch to “” range.

3. Press the Select Button to select the continuity measurement mode. The “” symbol will appear as an indicator.
4. Connect the red test lead to the anode of the diode to be tested and the black test lead to the cathode.
5. The meter will show the approximate forward voltage of the diode. If the connections are reversed, “OL” will be shown on the display.

Measuring Temperature

1. Set the range switch to the TEMP position.
2. Make sure the polarity of the thermocouple is correct; put the cold end (free end) of the thermocouple sensor into the terminal (Black to COM Jack and Red to “ °C °F Ω” Jack).
3. Set the working end (testing end) on or inside the object being tested.
4. The value of the temperature is shown on the display in degree centigrade.
5. Press the Select Button, fahrenheit and celsius can be converted back and forth.

Measuring Capacitance

1. Connect the Black test lead to the COM Jack and the Red test lead to the “ °C °F Ω” Jack.

2. Set the range switch to the “” position.
3. Connect the test leads across the capacitor being measured and be sure the polarity of the connection is observed.

NOTE: When the capacitance under measure is above 100uF, it needs at least 5 seconds to make reading stable.

Measuring Frequency (Auto Range)

1. Set the range switch to the Hz/Duty position.
2. Connect the Black test lead to the COM Jack and the Red test lead to the “ °C °F Ω” Jack.
3. Connect the test leads to the load being measured.

NOTE: Do not apply more than 250V rms to the input. It is possible to receive an indication of a voltage higher than 100V rms, but the reading may not be accurate.

While using the clamp to measure AC Current, press the  key, the meter will display the frequency of the measured current.

NOTE:

- a. The testing temperature is displayed automatically when the thermocouple is put into the testing jacks.
- b. The surrounding temperature is shown when the circuit of the sensor is cut off.
- c. The temperature limit measured by the thermocouple with the instrument is 250°C; 300°C is possible to measure within a short time period, but in order to measure even higher temperatures, it is necessary to purchase a higher range thermocouple.

AUTO POWER OFF

If the meter is idle for about 15 minutes, it will automatically power off. To turn it on again, just rotate the range switch or press a button.

BATTERY REPLACEMENT

If the low battery symbol (🔋) appears on the display, it indicates that the battery should be replaced. Remove the screws and open the back case. Replace the dead battery with a new one (9V NEDA 1604, 6F22 or equivalent).

INCLUDED IN BOX

- 1 x Owner's Manual
- 1 x Test Lead Pair
- 1 x K Type Thermocouple
- 1 x Battery (9V)

DISPOSAL OF THIS ARTICLE

If you at some point intend to dispose of this article, please keep in mind that many of its components consist of valuable materials, which can be recycled. Please do not discard it in the garbage bin, but check with your local authorities for recycling facilities in your area.

1 Year Warranty Limited Warranty From AstroAI

Each AstroAI Digital Multimeter will be free from defects in material and workmanship. This warranty does not cover fuses, disposable batteries and damage from neglect, misuse, contamination, alteration, accident, or abnormal conditions of operation or handling, including overvoltage failures caused by use outside the Multimeter's specified rating, or normal wear and tear of mechanical components. This warranty covers the original purchaser only and is not transferable.

If this product is defective, please contact AstroAI Customer Support at support@astroai.com.