DATA PROJECTOR

XJ-V Series

**XJ-V10X/XJ-V100W/
XJ-V110W**

XJ-F Series

**XJ-F10X/XJ-F20XN*/
XJ-F100W/
XJ-F200WN*/
XJ-F210WN***

* Network Models

* Modèles réseau

* Modelos de red

English

Setup Guide

- Be sure to keep all user documentation handy for future reference.
- To obtain the latest version of this manual visit the website at the URL below.
<http://world.casio.com/manual/projector/>

Français

Guide d'installation

- Conservez la documentation à portée de main pour toute référence future.
- Pour obtenir la toute dernière version de ce manuel, consultez le site à l'adresse suivante.
<http://world.casio.com/manual/projector/>

Español

Guía de configuración

- Asegúrese de tener a mano toda la documentación del usuario para futuras consultas.
- Para obtener la versión más reciente de este manual, visite nuestro sitio web en la siguiente URL.
<http://world.casio.com/manual/projector/>

Contents

Safety Precautions	EN-1	Quick Guide	EN-14
Operating Precautions	EN-6	Specifications	EN-15
General Guide	EN-12	TCO Certified Document URL.....	EN-18

Unpacking

As you unpack the projector, check to make sure that all of the items listed below are present.

- DATA PROJECTOR
- Wireless remote controller YT-151 (XJ-V Series, XJ-F10X, XJ-F100W)
- Wireless remote controller YT-141 (XJ-F20XN, XJ-F200WN, XJ-F210WN)
- Test Batteries (AAA-size × 2)
- AC Power Cord
- “Safety Precautions” Sheet
- “Read this first” Sheet
- Warranty

- DLP is a registered trademark of Texas Instruments Incorporated of the United States.
- HDMI, the HDMI Logo and High-Definition Multimedia Interface are trademarks or registered trademarks of HDMI Licensing, LLC.
- XGA is a registered trademark of IBM Corporation of the United States.
- Other company and product names may be registered trademarks or trademarks of their respective owners.



- The contents of this User’s Guide are subject to change without notice.
- Copying of this manual, either in part or its entirety, is forbidden. You are allowed to use this manual for your own personal use. Any other use is forbidden without the permission of CASIO COMPUTER CO., LTD.
- CASIO COMPUTER CO., LTD. shall not be held liable for any lost profits or claims from third parties arising out of the use of this product or this manual.
- CASIO COMPUTER CO., LTD. shall not be held liable for any loss or lost profits due to loss of data caused by malfunction or maintenance of this product, or any other reason.
- The sample screens shown in this manual are for illustrative purposes only, and may not be exactly the same as the screens actually produced by the product.

Safety Precautions

Thank you for selecting this CASIO product. Be sure to read these “Safety Precautions” before trying to use it. After reading this User’s Guide, keep it in a safe place for future reference.

About safety symbols

Various symbols are used in this User’s Guide and on the product itself to ensure safe use, and to protect you and others against the risk of injury and against material damage. The meaning of each of the symbols is explained below.

 Danger	This symbol indicates information that, if ignored or applied incorrectly, creates the risk of death or serious personal injury.
 Warning	This symbol indicates information that, if ignored or applied incorrectly, could possibly create the risk of death or serious personal injury.
 Caution	This symbol indicates information that, if ignored or applied incorrectly, could possibly create the risk of personal injury or material damage.

Icon Examples



A triangle indicates a situation against which you need to exercise caution. The example shown here indicates you should take precaution against electric shock.



A circle with a line through it indicates information about an action that you should not perform. The specific action is indicated by the figure inside the circle. The example shown here means disassembly is prohibited.



A black circle indicates information about an action that you must perform. The specific action is indicated by the figure inside the circle. The example shown here indicates you must unplug the power cord from the power outlet.

Precautions During Use

Warning

- **Adult supervision is required whenever there are young children present and especially when there is the possibility of young children coming into contact with the projector.**

- **Smoke, odor, heat, and other abnormalities**



Should you ever notice smoke, strange odor, or any other abnormality, immediately stop using the projector. Continued use creates the risk of fire and electric shock. Immediately perform the following steps.

1. Unplug the projector.
2. Contact your original dealer or authorized CASIO service center.

● Malfunction



Immediately stop using the projector if the screen appears abnormal, or if any other abnormal operation occurs even though you are operating the projector correctly. Continued use creates the risk of fire and electric shock. Immediately perform the following steps.

1. Turn off the projector.
2. Unplug the projector.
3. Contact your original dealer or authorized CASIO service center.

Safety Precautions

● Power cord



Misuse of the power cord creates the risk of fire and electric shock.

Make sure that you always observe the following precautions.

- Be sure to use only the accessories that come with the projector.
- Make sure that you use a power source with the same voltage as that specified for the projector.
- Do not overload a power outlet with too many devices.
- Do not locate the power cord near a stove.
- Do not use the power cord that comes with the projector with any other device.
- Do not share the outlet supplying power to the projector with other devices. If you are using an extension cord, make sure that the ampere rating of the extension cord is compatible with the power consumption value of this projector.
- Never use the power cord while it is still bundled together.
- Use a conveniently located power outlet that you can reach easily when you need to unplug the projector.



A damaged power cord creates the risk of fire and electric shock.

Make sure that you always observe the following precautions.

- Never place heavy objects on the power cord and never expose it to heat.
- Make sure the power cord is not pinched between the wall and the rack or table where the projector is located, and never cover the power cord with a cushion or other object.
- Never try to modify the power cord, allow it to become damaged, or subject it to excessive bending.
- Do not twist the power cord or pull on it.



Never touch the power cord or plug while your hands are wet.

Doing so creates the risk of electric shock.

- When using this projector in the country where you purchased it, be sure to use the power cord that came with it. Whenever using the projector in another country, be sure to purchase and use a power cord that is rated for the voltage of that country. Also make sure that you are aware of the Safety Standards that apply in that country.



When going out, make sure the projector is in a location away from pets and other animals, and unplug the power plug from the power outlet. A power cord damaged by chewing can cause shorts, and creates the risk of fire.

● Water and foreign matter



Never allow water to get on the projector. Water creates the risk of fire and electric shock.



Never place a vase or any other container of water on top of the projector. Water creates the risk of fire and electric shock.



Water or other liquid, or foreign matter (metal, etc.) getting into the projector creates the risk of fire and electric shock. Should anything get inside the projector, immediately perform the following steps.

1. Turn off the projector.
2. Unplug the projector.
3. Contact your original dealer or authorized CASIO service center.

● Disassembly and modification



Never try to take the projector apart or modify it in any way. The projector contains a large number of high-voltage components that create the risk of electric shock and burn injury. Also, note that problems caused by unauthorized projector disassembly or modification are not covered by the warranty and are not eligible for repair by CASIO.

Be sure to leave all internal inspection, adjustment, and repair up to your original dealer or authorized CASIO service center.

● Dropping and impact



Continued use of the projector after it has been damaged by dropping or other mistreatment creates the risk of fire and electric shock. Immediately perform the following steps.

1. Turn off the projector.
2. Unplug the projector.
3. Contact your original dealer or authorized CASIO service center.

● Disposal by burning



Never try to dispose of the projector by burning it. Doing so can cause an explosion, which creates the risk of fire and personal injury.

● Projector light emission



- Never look directly into the lens, intake vents, or exhaust vents while the light is on. When turning on the projector, check to make sure that no one is looking directly into its lens, intake vents, or exhaust vents. The strong light emitted by the projector creates the risk of eye damage.
- Do not attempt to use a magnifying glass, mirror, or other similar object to bend or reflect the projector's light, and never hold or place such object in the path of the projector's light. Refracted or reflected light can shine into a person's eyes and create the risk of eye damage.

● Blocking the vents



Never allow the vents to become blocked. Doing so causes internal heat build up, which creates the risk of fire and breakdown of the projector. Touching the projector while it is hot creates the risk of burn injury. Make sure that you always observe the following precautions.

- Allow at least 30cm (11.8 inches) between the projector and walls.
- Do not insert the projector into any space where air circulation is poor.
- Never cover the projector with a blanket or any similar item.
- Locate the projector on a firm, flat surface during use. Never use the projector while it is on a carpet, blanket, towel, seat cushion, or other pliable surface.
- Never stand the projector up on either end during use.

● Projector cabinet



Never open the projector's cabinet. Doing so creates the risk of electric shock.

● Cleaning



Before cleaning the projector, be sure to turn it off and unplug it from the power outlet. Failure to do so creates the risk of electric shock.

● Exhaust vents

The exhaust vents become very hot while the projector is running. Never touch them. Doing so creates the risk of burn injury. The areas near the exhaust vents also become quite hot. Never locate objects made of plastic or other heat-sensitive materials near or under the projector. Doing so creates the risk of deformation and discoloration of the object.

● Location

Never locate the projector in any of the following types of locations. Doing so creates the risk of fire and electric shock.

- Near an area subject to strong vibration
- An area subject to large amounts of moisture or dust
- In a kitchen or other area exposed to oil smoke
- Near a heater, on a heated carpet, or in an area exposed to direct sunlight
- An area subject to temperature extremes (Operating temperature range is 5°C to 35°C (41°F to 95°F)).

● Heavy objects

Never place heavy objects on the projector or climb on top of the projector. Doing so creates the risk of fire and electric shock.

● Water

Never locate the projector in a bathroom or anywhere else there is the chance that it will be splashed with water.

● Unstable location



Never place the projector on an unstable surface or on a high shelf. Doing so can cause it to fall, creating the risk of personal injury.

● Using the projector on a base with casters

Whenever using the projector on a base that has casters, make sure that you lock the casters when not moving the base.

Safety Precautions

● Lightning

During a lightning storm, do not touch the plug of the projector's power cord.

● Remote controller



Never try to take the remote controller apart or modify it in any way. Doing so creates the risk of electric shock, burn injury, and other personal injury. Be sure to leave all internal inspection, adjustment, and repair up to your original dealer or authorized CASIO service center.



Never allow the remote controller to become wet. Water creates the risk of fire and electric shock.

● Radio waves emitted by the optional wireless adapter YW-40



Never use this product inside of an aircraft or medical facility, or in any other location where use of such devices is prohibited. Radio waves can have an effect on the operation of electronic equipment and medical equipment, and cause accidents.



Do not use this product in the vicinity of high-precision electronic instruments or electronic devices that handle weak radio signals. Radio waves can have an effect on the operation of such equipment, and cause accidents.

- If you are using a pace maker or any other electronic medical device, be sure to consult your physician or device manufacturer before using this product.

● Do not use flammable gas sprays nearby



Do not spray flammable gas into or in the vicinity of the projector. The gas may ignite and create the risk of fire.



Caution

● Power cord



Misuse of the power cord creates the risk of fire and electric shock. Make sure that you always observe the following precautions.

- When unplugging the power cord, always grasp the plug, and do not pull on the power cord.
- Insert the plug into the power outlet as far as it will go.
- After using the projector, unplug it from the power outlet.
- Unplug the projector from the power outlet if you do not plan to use it for a long time.
- At least once a year, unplug the power plug and use a dry cloth or vacuum cleaner to clear dust from the area around the prongs of the power plug.
- Never use detergent to clean the power cord, especially the power plug and jack.
- Before moving the projector, be sure to turn it off and unplug it from the power outlet first.

● Backup of important data



Be sure to keep separate written records of all data stored in projector memory. Memory data can be lost due to breakdown, maintenance, etc.

● During projection, make sure there is nothing in front of the lens blocking the light.

An object in front of the lens creates the risk of fire.

● Lens effect

Never have an aquarium or any other object that produces a lens effect in front of the projector while the light source unit is on. Such an object creates the risk of fire.

● Lens

Never touch the lens with your hand.

● The optional wireless adapter YW-40



Keep the wireless adapter out of the reach of small children. Accidental swallowing of a wireless adapter can interfere with proper breathing and create a life-threatening situation.

Battery Precautions



Danger

 Should liquid leaking from an alkaline battery get into the eyes, immediately take the following steps.

1. Do not rub the eyes! Wash the eyes with clean water.
2. Contact a physician immediately. Failure to take immediate action can lead to loss of eyesight.

Warning

Misuse of batteries can cause them to leak and stain the area around them, or to explode, creating the risk of fire and personal injury. Make sure that you always observe the following precautions.

-  • Never try to take batteries apart and do not allow them to become shorted.
-  • Never expose batteries to heat or throw them into fire.
- Never mix old batteries and new ones.
- Never mix batteries of different types.
- Never try to charge batteries.
-  • Take care that batteries are oriented correctly when you load them.

Caution

Misuse of batteries can cause them to leak and stain the area around them, or to explode, creating the risk of fire and personal injury. Make sure that you always observe the following precaution.

-  • Use only the type of batteries that is specified for the remote controller.

● Dead batteries

Be sure to remove batteries from the remote controller as soon as they go dead.

-  • Remove batteries from the remote controller if you do not plan to use it for a long time.

● Disposing of batteries

Make sure that you dispose of used batteries in accordance with the rules and regulations in your local area.

Magnetism

Caution

 This projector has a magnet inside. Because of this, it should not be used in the vicinity of anyone wearing a pacemaker or any other electric medical device. Should any problem arise, move the projector away from the person experiencing the problem and consult a physician.

 Keep the projector away from floppy disks, magnetic cards, magnetic tapes, prepaid cards, checks, and any other media that uses magnetic recording. The projector can corrupt data recorded on magnetic media.

Other

Caution

Allowing dust to build up inside the projector by not cleaning it for long periods creates the risk of fire and accident, and can cause loss of projection luminosity. Contact your original dealer or authorized CASIO service center once a year about having the interior of the projector cleaned. Note that you will be charged for cleaning.

- **Be sure to follow all applicable local laws and regulations, and do not dismantle the projector when disposing of it.**

Operating Precautions

About the Light Source Unit

- The projector's light source unit uses a laser and LED.
- The life of the light source unit is rated at approximately 20,000 hours. The actual life will depend on use conditions, the settings configured on the setup menu, and differences between each individual light source unit.
- The light source unit is warranted for the period noted on the warranty certificate or for 6,000 hours, whichever comes first.
- The failure of the light source unit to light or a noticeable drop in light source unit brightness indicates the end of the light source unit's life. Contact your original dealer or authorized CASIO service center for replacement. Note that problems caused by unauthorized projector disassembly or modification are not covered by the warranty and are not eligible for repair by CASIO.

Laser Precautions

This projector is a Class 1 laser device that conforms with IEC 60825-1: 2014.

- This projector has a built-in laser module. Disassembly or modification is very dangerous and should never be attempted.
- Any operation or adjustment not specifically instructed by the user's guide creates the risk of hazardous laser radiation exposure.

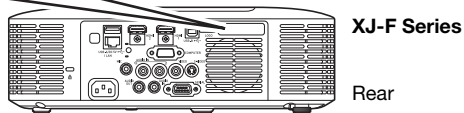
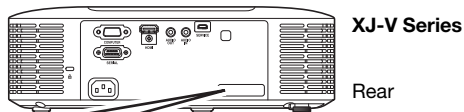
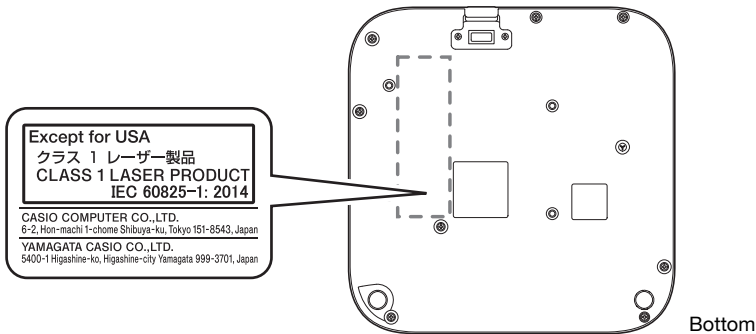

Operating Precautions

This projector is a Class 2 laser device that conforms with IEC 60825-1: 2007.

- This projector has a built-in laser module. Disassembly or modification is very dangerous and should never be attempted.
- Any operation or adjustment not specifically instructed by the user's guide creates the risk of hazardous laser radiation exposure.

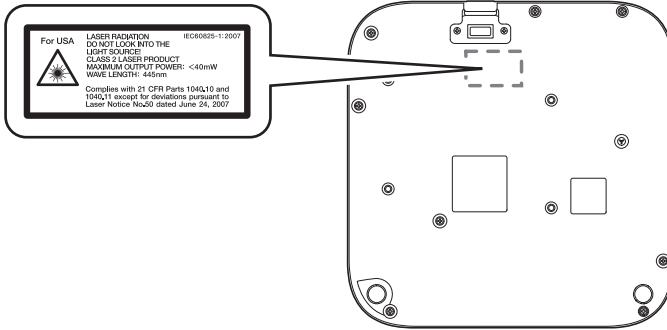

Bottom

Operating Precautions

Vent Outlets



- Vent outlets become very hot during projection. Never touch vents or allow them to become blocked.
- Do not insert foreign objects.

高温注意 CAUTION HOT
注意高温 ATTENTION CHAUD
고온주의 VORSICHT HEISS

注意

•内部に異物をいれなくてください。•投映中は、排気口が高温になります。排気口に触れたりふさがないでください。

Caution

•Do not insert foreign objects. •Vent outlets become very hot during projection. Never touch vents or allow them to become blocked.

주의

•내부에 이물질을 넣지 마십시오. •투영중에는 배기구가 고온이 됩니다. •절대로 배기구를 만지거나 막지 마십시오.

Attention

•Ne pas laisser pénétrer des matières étrangères l'intérieur. •Les sorties d'air deviennent très chaudes pendant la projection. Ne jamais les toucher ni les obstruer.

注意

•不要让异物混入。•使用过程中投影机通风口会非常热。切勿触摸通风口或使其被阻挡。

VORSICHT

•Stecken Sie keine Fremdkörper in das Gerät. •Die Entlüftungsöffnungen werden bei der Projektion sehr heiß. Berühren oder blockieren Sie die Öffnungen nicht.

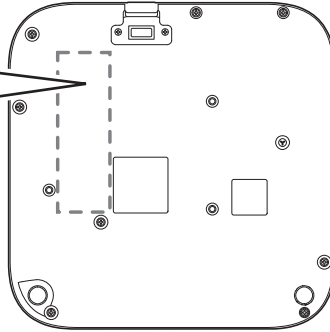

Bottom

Projector Light Emission



- Never block light output while the light is on.



- Never look directly into the lens while the light is on. Particular care is required when children are present.

警告! WARNING! AVERTISSEMENT!

•投影光を塞がない!
DO NOT BLOCK LIGHT OUTPUT!
NE PAS BLOQUER LA SORTIE DE LA LUMIÈRE!



不要遮挡投影光线!

•光源をのぞかない!
DO NOT LOOK INTO THE LIGHT SOURCE!
NE PAS REGARDER DIRECTEMENT VERS LA SOURCE LUMINEUSE!



不要窥视光源!

Other Precautions

This projector is made of precision components. Failure to observe the following precautions can result in inability to correctly save data and malfunction.

● **Never use or store the projector in the following locations. Doing so creates the risk of malfunction of and damage to the projector.**

- Locations subjected to electrostatic charge
- Locations subjected to temperature extremes
- Locations where there is extreme moisture
- Locations subjected to sudden temperature changes
- Locations where there is a lot of dust
- On a shaky, slanted, or otherwise unstable surface
- Locations where there is the danger of getting wet
- Locations where there are large amounts of oil smoke or other smoke
- Locations where there is the risk of salt damage

● **Ensure that the remote control signal receiver is not exposed fluorescent light, sunlight, or other strong light. Strong light can cause malfunction.**

● **Avoid using the projector under the following conditions. Such conditions create the risk of malfunction of and damage to the projector.**

- Avoid areas subject to temperature extremes (operating temperature range is 5°C to 35°C (41°F to 95°F)).
- Never place heavy objects on the projector or climb on top of the projector.
- Never insert or allow foreign objects to drop into the projector.
- Never place a vase or any other container of water on top of the projector.

● **Whenever setting the projector down or performing any operation that involves moving or reorienting it, take care that you do not pinch your fingers under the projector.**

● **Never leave dead batteries inside the remote controller for a long time.**

Dead batteries can leak, which leads to malfunction of and damage to the remote controller. Be sure to replace the batteries at least once every one year, no matter how much you use the remote controller during that time.

● **Clean with a soft, dry cloth.**

When very dirty, use a soft cloth that has been dampened in a weak solution of water and a mild neutral detergent. Wring all excess water from the cloth before wiping. Never use thinner, benzine, or any other volatile agent to clean the projector. Doing so can remove its markings and cause staining of the case.

● **Missing Screen Dots**

Though this projector is manufactured using the most advanced digital technology available today, some of the dots on the screen may be missing. This is normal, and does not indicate malfunction.

● **Never subject the projector to strong impact while it is projecting.**

If the projector is accidentally subjected to strong impact, the projection image will momentarily go blank. The image will reappear after some time, but it may be the wrong color or it may be accompanied by an error message.

If the projected image is the wrong color, re-select the current input source. If this does not return the projected image to its proper color, turn projector power off and then back on again.

If the image reappears with an error message, correct the problem in accordance with the indicator explanations under "Error Indicators and Warning Messages" in the User's Guide.

Operating Precautions

● Keystone Correction and Image Quality

Performing keystone correction causes the image to be compressed before it is projected. This can result in distortion of the image or a loss of image quality. If this happens, change the orientation of the projector and/or screen so it conforms as much as possible to the illustration under "Setting Up the Projector" in the User's Guide.

If image quality is the highest priority, turn off auto keystone correction and position the projector so it is pointed straight at the screen.

- Even if your projector is still within the warranty period, you will be charged for repair if a problem is due to running the projector non-stop for very long periods (like 24 hours) or if the projector was set up and used without following the "Setup Precautions" in the User's Guide.
- Use under high ambient temperature or in environments subjected to large amounts of dust, oil smoke, tobacco smoke, or other types of smoke can shorten the replacement cycles and require more frequent replacement of the optical engine and other components. Note that you are charged for such replacement. For details about replacement cycles and fees, contact an authorized CASIO service center.

● Condensation

Moving the projector from a cold room to a heated room, turning on a heater in a cold room, and other similar conditions can cause condensation (fogging) to form on the projector lens and/or inside the projector, which will make the projected image appear out of focus and can lead to malfunction and other trouble. If this happens, turn off the projector and wait for a while until the condensation clears naturally. When it does, you will be able to project images normally.

● Power Supply to External Equipment (XJ-F Series Only)

Turning off projector power also cuts power being supplied to external equipment. Note that power being supplied is also cut when the projector is turned off due to restarting by its self-check function or Auto Power Off, due to some error, or for any other reason. Depending on the external equipment being used, cut off of the power supply may cause data that is being edited to be lost or corrupted. Make it a habit to frequently save data on external equipment being powered by the projector. Note that CASIO COMPUTER CO., LTD. shall be held in no way liable for any loss or corruption of data.

Precaution when Handling the Projector after Use

The projector's exhaust vents and the area around the vents become very hot during operation, and will still be hot immediately after turning off the projector. Because of this, you should hold the sides of the projector as shown in the illustration whenever moving it.

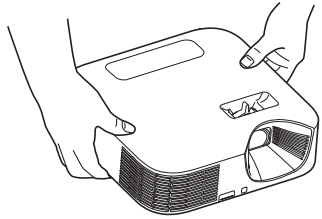

Cleaning the Projector

- Periodically clean the projector exterior, lens, intake vents, and exhaust vents on a regular basis.
- When cleaning the lens, do not apply undue force and take care to avoid damaging it.
- Dust and dirt tend to collect around the intake vents. Because of this, you should use a vacuum cleaner to clean away accumulated dust and dirt periodically (about once a month).
- Continued use of the projector after dust has accumulated around the intake vents can cause overheating of internal components and lead to malfunction.
- Certain operating conditions also can cause dirt and dust to accumulate around the projector's exhaust vents. If this happens, use the same procedure as that described above to clean the exhaust vents.

General Guide

Overview

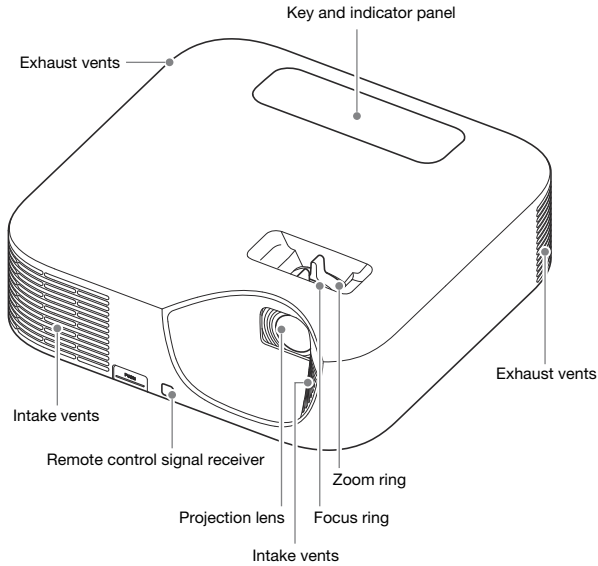

Key and Indicator Panel

XJ-V Series

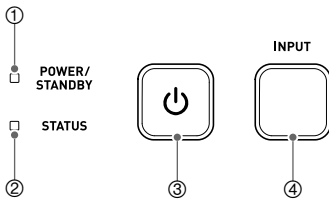

- ① POWER/STANDBY indicator
- ② STATUS indicator
- ③ [ON/Stand-by] key
- ④ [INPUT] key

XJ-F Series

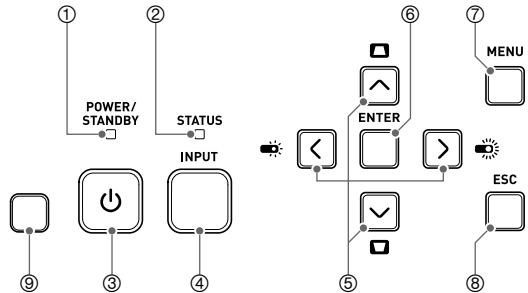

- ⑤ Cursor keys (▲/▼/◀/▶)
- ⑥ [ENTER] key
- ⑦ [MENU] key
- ⑧ [ESC] key
- ⑨ Brightness sensor

Back Terminals

XJ-V Series

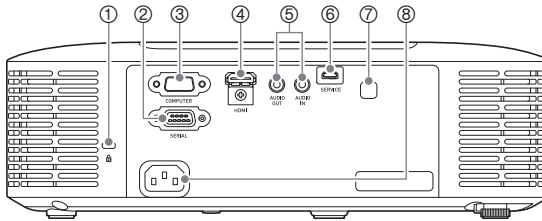

- | | |
|-------------------------|----------------------------------|
| ① Anti-theft lock hole* | ⑤ AUDIO OUT / AUDIO IN terminals |
| ② SERIAL terminal | ⑥ SERVICE port |
| ③ COMPUTER terminal | ⑦ Remote control signal receiver |
| ④ HDMI terminal | ⑧ Power connector |

XJ-F Series

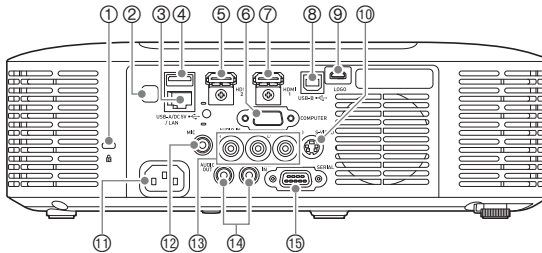

- | | |
|--|---|
| ① Anti-theft lock hole* | ⑧ USB-B port (Network models only) |
| ② Remote control signal receiver | ⑨ LOGO port |
| ③ LAN terminal (Network models only) | ⑩ S-VIDEO terminal |
| ④ DC 5V port (XJ-F10X/XJ-F100W)
USB-A/DC 5V port (XJ-F20XN/XJ-F200WN/
XJ-F210WN) | ⑪ Power connector |
| ⑤ HDMI 2 terminal | ⑫ MIC terminal (Network models only) |
| ⑥ COMPUTER terminal | ⑬ AUDIO IN R / AUDIO IN L / VIDEO terminals |
| ⑦ HDMI 1 terminal | ⑭ AUDIO OUT / AUDIO IN terminals |
| | ⑮ SERIAL port |

* The anti-theft lock hole is provided for connection of an anti-theft chain. Visit the Kensington Lock Website at <http://www.kensington.com/> for more information.

Quick Guide

This section explains the operational flow up to the point that projection is started. For more individual operations, see the “User’s Guide” (UsersGuide.pdf).

1. Load batteries into the remote controller.

☞ “To load remote controller batteries” (User’s Guide)

2. Place the projector onto a table, desk, or stand that is level and firm, making sure that you allow enough room around it.

☞ “Setting Up the Projector”, “Setup Precautions” (User’s Guide)

- Also, be sure to read the “Safety Precautions” (page EN-1) and the “Operating Precautions” (page EN-6).

3. Adjust the vertical angle of the projector.

- ① Lift up the front of the projector and press the release button. This causes the front foot to drop from the bottom of the projector.
- ② While holding down the release button, raise and lower the front of the projector. When the front foot is the height you want, release the release button. The front foot will lock at that position.
- ③ Make fine adjustments to the horizontal tilt of the projector by rotating the rear foot. Only one of the rear feet is adjustable to a height of ± 3 mm. The adjustable rear foot has a click position, which indicates the setting where its height is the same as that of the other rear foot.

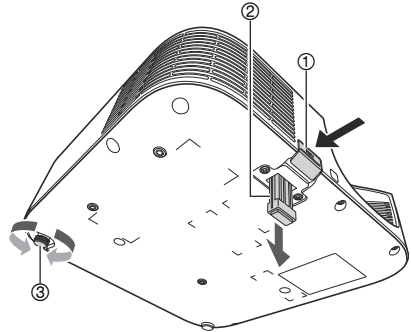

4. Use the supplied power cord to plug the projector into a power outlet.

5. Connect the projector to an image output device and then turn on the device.

☞ “Connecting Projector Cables” (User’s Guide)

6. Press the [⏻] key to turn on the projector.

- The first time you turn on the projector, a “Language” window will appear in the center of the projection screen. Select the language you want.

7. Use the [INPUT] key to select the input source.

☞ “Selecting the Input Source” (User’s Guide)

8. Use the zoom ring of the projector’s lens to adjust the size of the projected image.

9. Use the focus ring to adjust the focus.

10. Use the projector’s [◀] and [▶] keys to adjust brightness (XJ-F Series).

- With any projector model, you can adjust brightness using the remote controller’s [◀] and [▶] keys.

11. Use the projector’s [▲] and [▼] keys to adjust keystone correction (XJ-F Series).

- With any projector model, you can adjust keystone correction using the remote controller’s [KEYSTONE +] and [KEYSTONE -] keys.

12. After you finish projecting, press the [⏻] key to turn off the projector.

NOTE

- This product is also designed for IT power distribution system with phase-to-phase voltage 230V.

If you run into problems...

If you experience any problems while operating the projector or if you suspect that the projector is not operating properly, refer to the “Troubleshooting” section in the “User’s Guide” (UsersGuide.pdf).

Specifications

Model Name		XJ-V10X	XJ-V100W	XJ-V110W
Display System		DLP® chip × 1, DLP® system		
Display Chip	Chip Size	XGA 0.55 inches (Aspect ratio: 4:3)	WXGA 0.65 inches (Aspect ratio: 16:10)	
	Number of Pixels	786,432 (1024 × 768)	1,024,000 (1280 × 800)	
Projection Lens		1.5X manual zoom, manual focus F 2.31-2.73 / f 18.9-27.2		
Light Source		Laser and LED		
Projected Image Size		30 to 300 inches	35 to 300 inches	
Projection Distance	60 inches	1.95 to 2.87 meters (6.4 to 9.4 feet)	1.64 to 2.42 meters (5.4 to 7.9 feet)	
	100 inches	3.33 to 4.85 meters (10.9 to 15.9 feet)	2.81 to 4.11 meters (9.2 to 13.5 feet)	
	Minimum Projection Distance	0.93 meters (3.1 feet)	0.92 meters (3.0 feet)	
Color Reproduction		Full color (up to 1.07 billion colors)		
Brightness		3300 lumens	3000 lumens	3500 lumens
Contrast Ratio (Full White / Black)		20000:1		
Scanning Frequencies	Horizontal	15 to 91 kHz		
	Vertical	50 to 85 Hz		
Display Resolution	RGB Signal	Native: 1024 × 768	Native: 1280 × 800	
		Maximum: 1920 × 1200 (WUXGA) resizing		
	Component Signal	Maximum: 1920 × 1080 (HDTV 1080P)		
	HDMI Signal	Maximum: 1920 × 1200 (WUXGA)		

Specifications

Model Name		XJ-V10X	XJ-V100W	XJ-V110W
Terminals	RGB input	COMPUTER terminal: RGB 15-pin mini D-Sub × 1; Used for both RGB input and component (YCbCr/YPbPr) input.		
	Component Input			
	Digital Video Input	HDMI input terminal: HDMI type A terminal × 1 HDCP support, audio signal support		
	Audio Input	3.5 mm stereo mini jack × 1		
	Audio Output	3.5 mm stereo mini jack × 1		
	USB Device	Micro-USB type B × 1: For firmware update		
	Control Terminal	RS-232C (D-sub 9 pin) × 1		
Operating Temperature		5 to 35°C (41 to 95°F)		
Operating Humidity		20 to 80% (non-condensation)		
Operating Altitude		0 to 3,000 meters (0 to 10,000 feet) above sea level		
Power Requirements		100 to 240V~(AC), 50/60Hz		
Power Consumption (100 to 240V)				
Light Output 7 when "Light Control" is "On"		145W	125W	155W
Light Output 1 when "Light Control" is "On"		75W	60W	80W
When "Bright" is selected for "Light Control Off Mode".		180W	150W	190W
When "Normal" is selected for "Light Control Off Mode".		155W	135W	165W
Standby Power Consumption		100 to 120V: 0.12W 220 to 240V: 0.23W		
Approximate Dimensions		299 (W) × 299 (D) × 97 (H) mm (11.8" × 11.8" × 3.8") (Including projections)		
Approximate Weight		3.5kg (7.7lbs)		

Model Name		XJ-F10X XJ-F20XN	XJ-F100W	XJ-F200WN	XJ-F210WN
Display System		DLP® chip × 1, DLP® system			
Display Chip	Chip Size	XGA 0.55 inches (Aspect ratio: 4:3)	WXGA 0.65 inches (Aspect ratio: 16:10)		
	Number of Pixels	786,432 (1024 × 768)	1,024,000 (1280 × 800)		
Projection Lens		1.5X manual zoom, manual focus			
		F 2.31-2.73 / f 18.9-27.2			
Light Source		Laser and LED			
Projected Image Size		30 to 300 inches	35 to 300 inches		

Specifications

Model Name		XJ-F10X XJ-F20XN	XJ-F100W	XJ-F200WN	XJ-F210WN
Projection Distance	60 inches	1.95 to 2.87 meters (6.4 to 9.4 feet)	1.64 to 2.42 meters (5.4 to 7.9 feet)		
	100 inches	3.33 to 4.85 meters (10.9 to 15.9 feet)	2.81 to 4.11 meters (9.2 to 13.5 feet)		
	Minimum Projection Distance	0.93 meters (3.1 feet)	0.92 meters (3.0 feet)		
Gamut		Full color (up to 1.07 billion colors)			
Brightness		3300 lumens	3500 lumens	3000 lumens	3500 lumens
Contrast Ratio (Full White / Black)		20000:1			
Scanning Frequencies	Horizontal	15 to 91 kHz			
	Vertical	50 to 85 Hz			
Display Resolution	RGB Signal	Native: 1024 × 768	Native: 1280 × 800		
		Maximum: 1920 × 1200 (WUXGA) resizing			
	Component Signal	Maximum: 1920 × 1080 (HDTV 1080P)			
	HDMI Signal	Maximum: 1920 × 1200 (WUXGA)			
	Video Signal	NTSC, PAL, PAL-N, PAL-M, PAL60, SECAM			
Terminals	RGB input	COMPUTER terminal: RGB 15-pin mini D-Sub × 1 Used for both RGB input and component (YCbCr/YPbPr) input.			
	Component Input				
	Digital Video Input	HDMI input terminal: HDMI type A terminal × 2 HDCP support, audio signal support			
	Analog Video Input	Composite (RCA) terminal × 1, S-video terminal × 1			
	Audio Input	RCA R/L terminals, 3.5 mm stereo mini jack × 1			
	Audio Output	3.5 mm stereo mini jack × 1			
	Mic Input *1	3.5 mm monaural mini jack × 1			
	USB Host	USB type A × 1 *2			
	USB Device	USB type B × 1 *2 Micro-USB type B × 1: For firmware update and logo data registration			
	Power Supply Port	DC 5V/2A × 1 (On XJ-F20XN, XJ-F200WN, XJ-F210WN, doubles as USB host port.)			
	Control Terminal	RS-232C (D-sub 9 pin) × 1			
LAN Terminal	RJ-45 × 1 *2				
Wireless Support *3		IEEE 802.11b/g/n compatible *2			
Speaker		16W × 1, Monaural			
Operating Temperature		5 to 35°C (41 to 95°F)			
Operating Humidity		20 to 80% (non-condensation)			
Operating Altitude		0 to 3,000 meters (0 to 10,000 feet) above sea level			
Power Requirements		100 to 240V ~ (AC), 50/60Hz			

Specifications

Model Name	XJ-F10X XJ-F20XN	XJ-F100W	XJ-F200WN	XJ-F210WN
Power Consumption (100 to 240V)				
Light Output 7 when "Light Control" is "On"	160W	165W	140W	165W
Light Output 1 when "Light Control" is "On"	80W	85W	70W	85W
When "Bright" is selected for "Light Control Off Mode".	195W	205W	165W	205W
When "Normal" is selected for "Light Control Off Mode".	170W	175W	150W	175W
Standby Power Consumption (100 to 120V)				
When "Disable" is specified for "Remote On" *4	0.12W			
When "Enable" is specified for "Remote On" *4	1.9W			
Standby Power Consumption (220 to 240 V)				
When "Disable" is specified for "Remote On" *4	0.23W			
When "Enable" is specified for "Remote On" *4	2.3W			
Approximate Dimensions	299 (W) × 299 (D) × 97 (H) mm (11.8" × 11.8" × 3.8") (Including projections)			
Approximate Weight	3.8kg (8.4lbs)			

*1 Plug-in power type microphones are not supported.

*2 XJ-F20XN/XJ-F200WN/XJ-F210WN only

*3 With connection of optional wireless adapter (YW-40) to USB-A port on the back of the projector.

*4 For information about configuring the Remote On setting, see the separate "Network Function Guide".

Specifications are subject to change without notice.

TCO Certified Document URL

<http://world.casio.com/projector/tco/>

GUIDELINES LAID DOWN BY FCC RULES FOR USE OF THIS UNIT IN THE U.S.A. (not applicable to other areas).

NOTICE

This equipment has been tested and found to comply with the limits for a Class B digital device, pursuant to Part 15 of the FCC Rules. These limits are designed to provide reasonable protection against harmful interference in a residential installation. This equipment generates uses and can radiate radio frequency energy and, if not installed and used in accordance with the instructions, may cause harmful interference to radio communication. However, there is no guarantee that interference will not occur in a particular installation. If this equipment does cause harmful interference to radio or television reception, which can be determined by turning the equipment off and on, the user is encouraged to try to correct the interference by one or more of the following measures:

- Reorient or relocate the receiving antenna.
- Increase the separation between the equipment and receiver.
- Connect the equipment into an outlet on a circuit different from that to which the receiver is connected.
- Consult the dealer or an experienced radio/TV technician for help.

FCC CAUTION

Changes or modifications not expressly approved by the party responsible for compliance could void the user's authority to operate the equipment.

Proper connectors must be used for connection to host computer and/or peripherals in order to meet FCC emission limits.

Connector cable....XJ-V10X/XJ-V100W/XJ-V110W/XJ-F10X/XJ-F100W/XJ-F20XN/XJ-F200WN/XJ-F210WN unit to PC

Declaration of Conformity

Model Number: XJ-V10X/XJ-V100W/XJ-V110W/XJ-F10X/XJ-F100W/XJ-F20XN/XJ-F200WN/XJ-F210WN

Trade Name: CASIO COMPUTER CO., LTD.

Responsible party: CASIO AMERICA, INC.

Address: 570 MT. PLEASANT AVENUE, DOVER, NEW JERSEY 07801

Telephone number: 973-361-5400

This device complies with Part 15 of the FCC Rules, Operation is subject to the following two conditions:

(1) This device may not cause harmful interference, and (2) this device must accept any interference received, including interference that may cause undesired operation.



CASIO COMPUTER CO., LTD.

XJ-V10X/XJ-V100W/XJ-V110W/

XJ-F10X/XJ-F100W/XJ-F20XN/

XJ-F200WN/XJ-F210WN

FOR CALIFORNIA USA ONLY

Perchlorate Material – special handling may apply.

See www.dtsc.ca.gov/hazardouswaste/perchlorate.

This Class B digital apparatus complies with Canadian ICES-003.

Cet appareil numérique de la classe B est conforme à la norme NMB-003 du Canada.

HDMI[®]
HIGH-DEFINITION MULTIMEDIA INTERFACE



Manufacturer:

CASIO COMPUTER CO., LTD.

6-2, Hon-machi 1-chome, Shibuya-ku, Tokyo 151-8543, Japan

Responsible within the European Union:

Casio Europe GmbH

Casio-Platz 1, 22848 Norderstedt, Germany

www.casio-europe.com

CASIO®

CASIO COMPUTER CO., LTD.
6-2, Hon-machi 1-chome
Shibuya-ku, Tokyo 151-8543, Japan

MA1705-B

© 2016 CASIO COMPUTER CO., LTD.