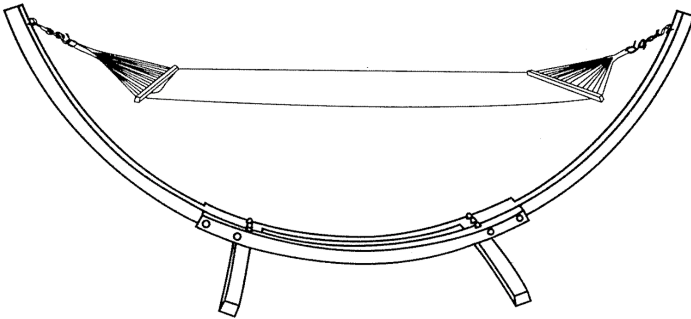

BELLEZE[®]

THE FURNITURE COMPANY



Owner's Manual

Wood Hammock Stand w/
Cotton Hammock

item no. 014-HG-14503 / 014-HG-14504

FOLLOW US:



CONTACT INFO:

www.bellezefurniture.com
(949) 344-2588

NOTE:

The instruction booklet contains **IMPORTANT** safety information Please read and keep for future reference.

OUR BRAND

Belleze is one of the nation's largest direct sellers of home decor. We offer an extensive selection of high-quality indoor and outdoor furniture, appliances, and accessories. We are committed to making decorating your home easy, affordable and fun. Everything you need to make your house into a beautiful home can be found at Belleze. So whether you shop by website or catalog, you can be sure you will always find top-quality merchandise for your home.

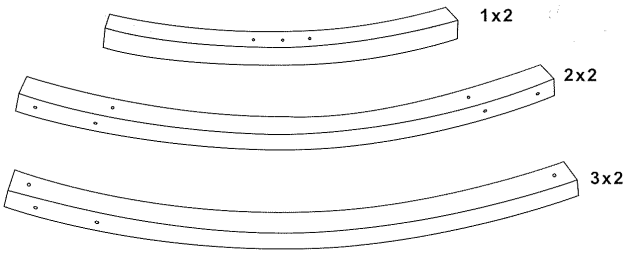
PLEASE LIKE, COMMENT AND SUBSCRIBE.

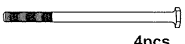

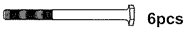












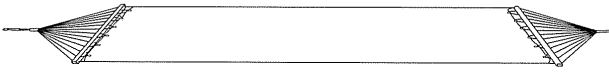
TABLE OF CONTENTS

OUR BRAND	03
INSTRUCTION MANUAL	04
WARRANTY	07

INSTRUCTIONS MANUAL

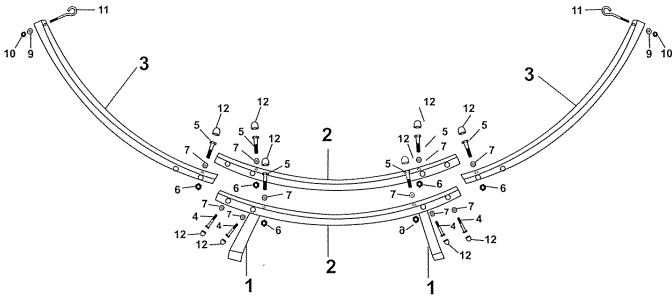


4	 4pcs	9	 2pcs
5	 6pcs	10	 2pcs
6	 10pcs	11	 2pcs
7	 20pcs	12	 14pcs
8	 4pcs	13	 2pcs
 1pcs  1pcs		 1pcs	

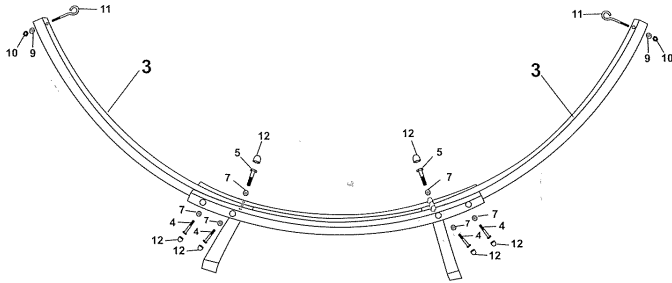


INSTRUCTION MANUAL

1.

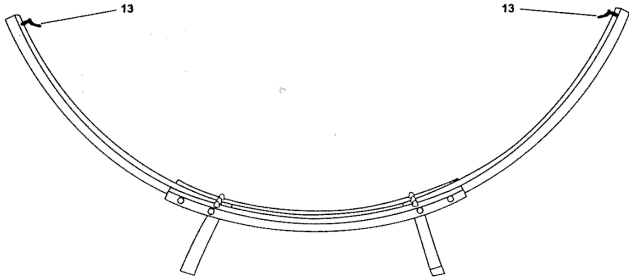


2.

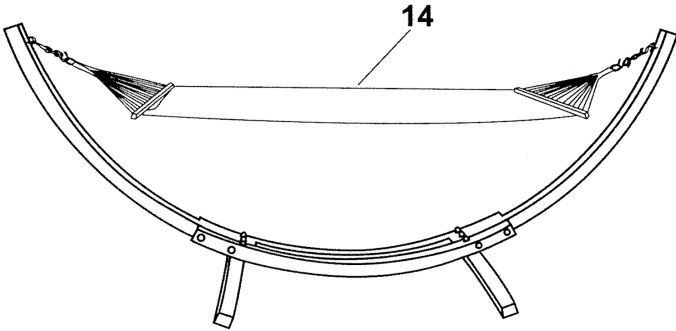


INSTRUCTION MANUAL

3.



4.



LIMITED TERM WARRANTY

ONE (1) YEAR FROM DATE OF PURCHASE

WARRANTY TERMS

BELLEZE warrants that its merchandise are free from manufacturing defects (workmanship and/or material) and will either give credit or replace defective parts for a period of up to one (1) year from the date of purchase in accordance with the conditions set forth below. If a manufacturing defect is found, BELLEZE should be notified promptly of the defect and supplied a copy of the invoice and delivery ticket. Inspection by a BELLEZE employee or representative may be necessary to verify that a manufacturing defect exists, or you may be required to submit samples to BELLEZE along with a digital image of the defects. If replacement is required in accordance with this warranty and the defective material or merchandise has been discontinued or unavailable, BELLEZE reserves the right to select and supply similar merchandise or offer full credit for the merchandise; otherwise the same material or merchandise will be supplied for replacement purposes. This warranty is made solely to the retailer and is not transferable under any circumstances. It is the retailer's responsibility to contact BELLEZE with a claim. We will not handle claims from consumers directly; all requests must go through the retailer who sold the merchandise to the consumer. We advise all retailers to retain invoices for a minimum of one (1) year for warranty purposes. This warranty supersedes and replaces all implied warranties of merchantability and use for particular purpose. No representative, employee, or agent of BELLEZE or any other person is authorized to assume for BELLEZE any additional liability or responsibility in connection with BELLEZE's merchandise except as described above. Implied warranties or merchantability and fitness of the merchandise are limited to a period of one (1) year from the date of purchase. In no event shall BELLEZE be liable for indirect, consequential or incidental damages of any kind.

ADDITIONAL CONDITIONS

The following examples are not manufacturer's defects:

- Colors may vary slightly from the photo because of photography and printing tolerances.
- Sizes are stated in U.S. standard measurements while the actual sizes are manufactured using the metric system. Therefore the sizes may vary slightly.
- There are no exchanges or refunds on any pillows or toppers sold.
- No returns for buyer's remorse.
- * No returns - other than stated above - will be accepted

ADDITIONAL CONDITIONS

Warranty is void for any of the following conditions:

- 1 Improper maintenance or improper use resulting in damage.
- 2 Any product modifications by dealer, consumer, or other parties not authorized by BELLEZE will void this warranty.
- 3 Floor samples sold or products designated "AS IS" at the time of purchase are not covered by the warranty.
- 4 Warranty does not cover minor variations or differences between floor samples or printed illustrations and your furniture.
- 5 Cost of packaging and shipping to and from BELLEZE is not covered by the warranty unless expressly arranged by BELLEZE.
- 6 This warranty covers only articles of appliances intended for residential use only, does not cover any industrial, commercial, institutional, or rental use.
- 7 Dissatisfaction due to buyer's remorse.
- 8 Normal wear and tear.
- 9 Damages incurred during transportation.
- 10 Damages incurred during assembling or maintenance.
- 11 Damages incurred by accidents or abuse.

Additional conditions for warranty on upholstery are listed on the attached addendum.

FOLLOW US:



CONTACT INFO:

www.bellezefurniture.com
(949) 344-2588

BELLEZE[®]