

net**atmo**

welcome

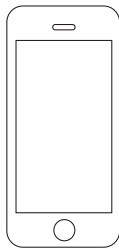

<https://welcome.netatmo.com>

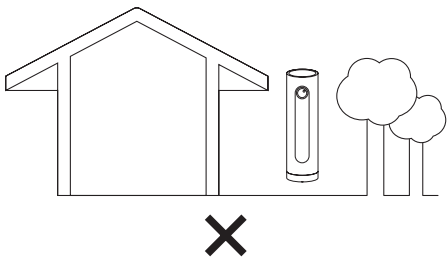
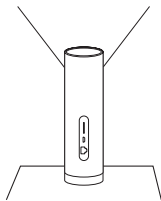
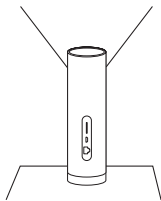
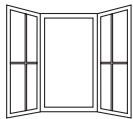
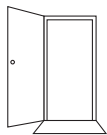
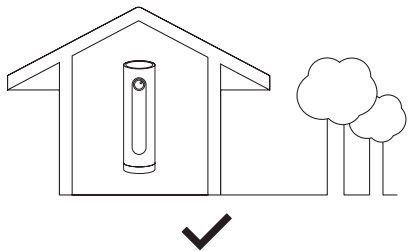

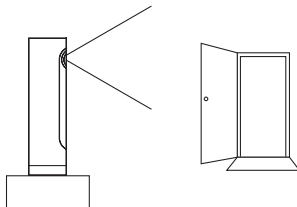
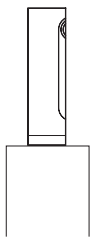
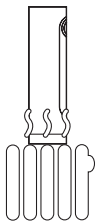

1m - 5m  
6ft - 16ft

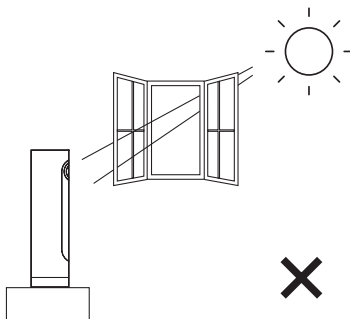
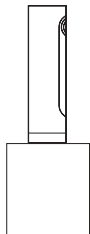
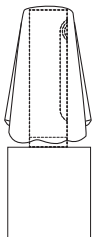

Thank you !

## Legal Notice

### EU Declaration of Conformity

We, Netatmo, declare that this device is in compliance with the essential requirements and other relevant provisions of Directive 1999/5/EC.

### Български [Bulgarian]

Netatmo декларира, че това NSC01 е в съответствие със съществените изисквания и другите приложими правила на Директива 1999/5/EC и ROHS 2011/65/ES.

### Česky [Czech]

Netatmo tímto prohlašuje, že tento NSC01 je ve shodě se základními požadavky a dalšími příslušnými ustanoveními směrnice 1999/5/ES a ROHS 2011/65/ES.

### Dansk [Danish]

Undertegnede Netatmo erklærer herved, at følgende udstyr NSC01 overholder de væsentlige krav og øvrige relevante krav i direktiv 1999/5/EF og ROHS 2011/65/EF.

### Deutsch [German]

Hiermit erklärt Netatmo, dass sich das Gerät NSC01 in Übereinstimmung mit den grundlegenden Anforderungen und den übrigen einschlägigen Bestimmungen der Richtlinie 1999/5/EG und ROHS 2011/65/EG befindet.

### Eesti [Estonian]

Käesolevaga kinnitab Netatmo seadme NSC01 vastavust direktiivi 1999/5/EÜ ja ROHS 2011/65/EÜ põhinõuetele ja nimetatud direktiivist tulenevatele teistele asjakohastele sätetele.

### English

Hereby, Netatmo declares that this NSC01 is in compliance with the essential requirements and other relevant provisions of Directive 1999/5/EC and ROHS 2011/65/EC.

### Español [Spanish]

Por medio de la presente Netatmo declara que el NSC01 cumple con los requisitos esenciales y cualesquiera otras disposiciones aplicables o exigibles de la Directiva 1999/5/CE y ROHS 2011/65/CE.

### Ελληνική [Greek]

ΜΕ ΤΗΝ ΠΑΡΟΥΣΑ Netatmo ΔΗΛΩΝΕΙ ΟΤΙ NSC01 ΣΥΜΜΟΡΦΩΝΕΤΑΙ ΠΡΟΣ ΤΙΣ ΟΥΣΙΩΔΕΙΣ ΑΠΑΙΤΗΣΕΙΣ ΚΑΙ ΤΙΣ ΛΟΙΠΕΣ ΣΧΕΤΙΚΕΣ ΔΙΑΤΑΞΕΙΣ ΤΗΣ ΟΔΗΓΙΑΣ 1999/5/ΕΚ και ROHS 2011/65/ΕΚ.

**Français [French]**

Par la présente Netatmo déclare que l'appareil NSC01 est conforme aux exigences essentielles et aux autres dispositions pertinentes de la directive 1999/5/CE et ROHS 2011/65/CE.

**Hrvatski [Croatian]**

Ovime, Netatmo izjavljuje da je ovaj NSC01 u skladu s osnovnim zahtjevima i drugim relevantnim odredbama Direktive 1999/5/EC i ROHS 2011/65/EC.

**Italiano [Italian]**

Con la presente Netatmo dichiara che questo NSC01 è conforme ai requisiti essenziali ed alle altre disposizioni pertinenti stabilite dalla direttiva 1999/5/CE e ROHS 2011/65/CE.

**Latviski [Latvian]**

Ar šo Netatmo deklarē, ka NSC01 atbilst Direktīvas 1999/5/EK un ROHS 2011/65/EK būtiskajām prasībām un citiem ar to saistītajiem noteikumiem.

**Lietuvių [Lithuanian]**

Šiuo Netatmo deklaruoją, kad šis NSC01 atitinka esminius reikalavimus ir kitas 1999/5/EB ir ROHS 2011/65/EB Direktyvos nuostatas.

**Nederlands [Dutch]**

Hierbij verklaart Netatmo dat het toestel NSC01 in overeenstemming is met de essentiële eisen en de andere relevante bepalingen van richtlijn 1999/5/EG en ROHS 2011/65/EG.

**Malti [Maltese]**

Hawnhekk, Netatmo, jiddikjara li dan NSC01 jikkonforma mal-htigijiet essenzjali u ma provvedimenti oħrajn rilevanti li hemm fid-Direttiva 1999/5/EC u ROHS 2011/65/EC.

**Magyar [Hungarian]**

Alulírott, Netatmo nyilatkozom, hogy a NSC01 megfelel a vonatkozó alapvető követelményeknek és az 1999/5/EC i ROHS 2011/65/EC irányelv egyéb előírásainak.

**Norsk [Norwegian]**

Netatmo erklærer herved at dette NSC01 er i samsvar med de grunnleggende kravene og øvrige relevante krav i EU-direktivet 1999/5/EF og ROHS 2011/65/EC.

**Polski [Polish]**

Niniejszym Netatmo oświadczam, że NSC01 jest zgodny z zasadniczymi wymogami oraz pozostałymi stosownymi postanowieniami Dyrektywy 1999/5/EC i ROHS 2011/65/EC.

**Português [Portuguese]**

Netatmo declara que este NSC01 está conforme com os requisitos essenciais e outras disposições da Directiva 1999/5/CE e ROHS 2011/65/CE.

**Română [Romanian]**

Prin prezenta, Netatmo declară că acest NSC01 este în conformitate cu cerințele esențiale și cu celelalte prevederi relevante ale Directivei 1999/5/CE și ROHS 2011/65/EC.

**Slovensko [Slovenian]**

Netatmo izjavlja, da je ta NSC01 v skladu z bistvenimi zahtevami in ostalimi relevantnimi določili direktive 1999/5/ES in ROHS 2011/65/ES.

**Slovensky [Slovak]**

Netatmo týmto vyhlasuje, že NSC01 spĺňa základné požiadavky a všetky príslušné ustanovenia Smernice 1999/5/ES a ROHS 2011/65/ES.

**Suomi [Finnish]**

Netatmo vakuuttaa täten että NSC01 tyyppinen laite on direktiivin 1999/5/EY ja ROHS 2011/65/EY oleellisten vaatimusten ja sitä koskevien direktiivin muiden ehtojen mukainen.

**Svenska [Swedish]**

Härmed intygar Netatmo att denna NSC01 står i överensstämmelse med de väsentliga egenskapskrav och övriga relevanta bestämmelser som framgår av direktiv 1999/5/EG och ROHS 2011/65/EG.

<http://www.netatmo.com/declaration/nsc>

Netatmo SAS – 93, rue nationale – 92100 Boulogne-Billancourt

Boulogne-Billancourt, 12/05/2015

CEO

Frédéric POTTER



### Caution!

Any changes or modifications to this unit not expressly approved by the party responsible for compliance could void the user's authority to operate the equipment.

### Legal notice

"Made for iPod", "Made for iPhone", "Made for iPad" mean that an electronic accessory has been designed to connect specifically to iPod, iPhone and iPad and has been certified by the developer to meet Apple performance standards. Apple is not responsible for the operation of this device or its compliance with safety and regulatory standards. Please note that the use of this accessory with iPhone may affect wireless performance.

### Safety warnings

This device is not intended for use by persons (including children) with reduced physical, sensory or mental capabilities, or lack of experience and knowledge, unless they have been given supervision or instruction concerning use of the appliance by a person responsible for their safety. Children should be supervised to ensure that they do not play with the appliance. Use only with supplied USB wall adaptor. The USB wall adaptor is for indoor use only.

### Consignes de sécurité

Cet appareil n'est pas destiné à être utilisé par des personnes (notamment des enfants) dont les capacités physiques, sensorielles ou mentales sont réduites, ou qui n'ont pas d'expérience et de connaissances, à moins qu'elles ne soient surveillées ou instruites concernant l'utilisation de l'appareil par une personne responsable de leur sécurité. Les enfants doivent être surveillés pour s'assurer qu'ils ne jouent pas avec l'appareil. Utilisez uniquement l'adaptateur USB fourni. Cet adaptateur ne doit être utilisé qu'en intérieur.

### Canadian Compliance Statement

This device complies with Industry Canada license-exempt RSS standard(s). Operation is subject to the following two conditions: (1) this device may not cause interference, and (2) this device must accept any interference, including interference that may cause undesired operation of the device. Cet appareil est conforme aux normes CNR exemptes de licence d'Industrie Canada. Le fonctionnement est soumis aux deux conditions suivantes: (1) cet appareil ne doit pas provoquer d'interférences et (2) cet appareil doit accepter toute interférence, y compris celles susceptibles de provoquer un fonctionnement non souhaité de l'appareil. This Class B digital apparatus complies with Canadian ICES-003. Cet appareil numérique de la classe B est conforme à la norme NMB-003 du Canada. This device and its antenna(s) must not be co-located or operating in conjunction with any other antenna or transmitter. Cet appareil et son antenne (s) ne doit pas être co-localisés ou fonctionnant en conjonction avec une autre antenne ou transmetteur.

### Taiwan Wireless Statements

無線設備的警告聲明

本產品符合低功率電波輻射性電機管理辦法第十二條、十四條等條文規定:

- 1.經型式認證合格之低功率射頻電機，非經許可，公司、商號或使用者均不得擅自變更頻率、加大功率或變更原設計之特性及功能。
  - 2.低功率射頻電機之使用不得影響飛航安全及干擾合法通信；經發現有干擾現象時，應立即停用，並改善至無干擾時方得繼續使用。
- 前項合法通信，指依電信法規定作業之無線電通信。低功率射頻電機須忍受合法通信或工業、科學及醫療用電波輻射性電機設備之干擾。

## **WARNING**

### **Privacy**

The Netatmo Welcome camera is designed for an indoor personal use. Countries' laws and regulations may restrict the use of your Netatmo Welcome. Please check the laws of your country.

To respect privacy, please avoid installing your Netatmo Welcome monitoring the street or your neighbors' property. We also advise you to inform your family, relatives and home employees, if any, that you have installed a camera.

### **Security**

Welcome features are not certified for emergency response. Netatmo will not dispatch emergency authorities to your home. The alarm detection feature may not work with some alarm patterns. It is not to be used as a replacement for an existing alarm system.

Mobile notifications are provided for informational purposes only.

By using Netatmo Welcome you agree that you will not rely on its services for any life safety or critical purposes.

## **DISCLAIMER**

### **Vie privée**

La caméra Welcome est destinée à un usage domestique et personnel. Les lois en vigueur dans votre pays peuvent restreindre l'utilisation de votre Netatmo Welcome. Veuillez vous renseigner sur les lois de votre pays.

Afin de respecter la vie privée, veuillez ne pas positionner Welcome de manière à ce qu'elle puisse filmer des lieux publics ou les propriétés voisines. Nous vous conseillons de même de tenir au courant votre famille, proches et employés de maison de l'installation d'une caméra.

### **Sécurité**

Les services de Welcome ne sont pas homologués pour répondre à des situations d'urgence. Netatmo ne contactera jamais les autorités à votre place. La fonctionnalité détection d'alarmes peut ne pas fonctionner avec certains modèles d'alarmes. Welcome n'est pas destinée à remplacer un système de sécurité existant.

Les notifications mobiles sont envoyées à titre d'information seulement.

En utilisant Netatmo Welcome, vous acceptez de ne pas vous reposer uniquement sur ses services lors de situations impliquant la sécurité des biens et personnes, ou la vie.



② <https://support.netatmo.com>



Copyright Netatmo © 2016 All rights reserved. Reproduction and distribution prohibited without written authorization from Netatmo