

INSTALLATION INSTRUCTIONS

63-6014

NISSAN

2008-09 FRONTIER / PATHFINDER / XTERRA

V6-4.0L

NOTE: This kit was not designed to fit vehicles with a body lift.

TOOLS NEEDED:

Flat Blade Screwdriver
Phillips Screwdriver
Ratchet
Extension
10mm Socket
13mm Socket
10mm Wrench
Pliers

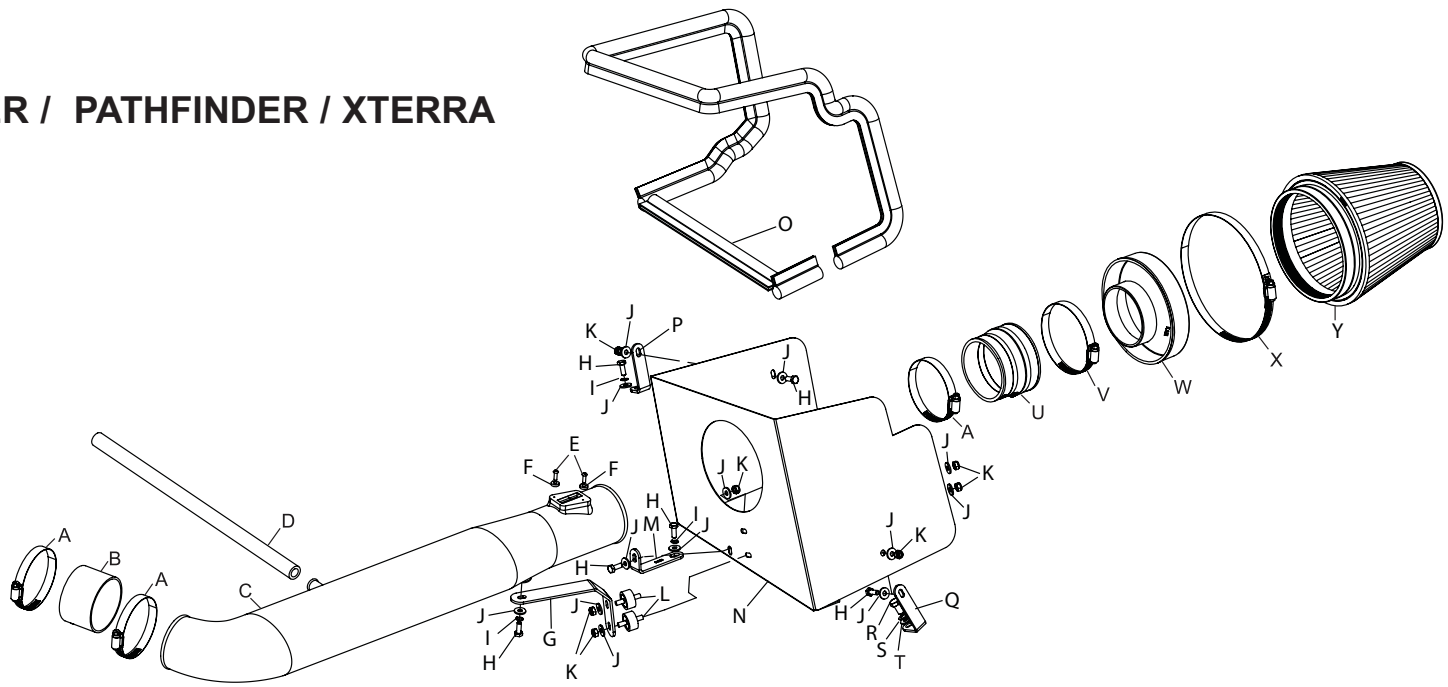

NOTE: FAILURE TO FOLLOW INSTALLATION INSTRUCTIONS AND NOT USING THE PROVIDED HARDWARE MAY DAMAGE THE INTAKE TUBE, THROTTLE BODY AND ENGINE.

PARTS LIST:

Desc.	Part #	QTY.	Desc.	Part #	QTY.	Desc.	Part #	QTY.
A Hose Clamp #48	3	08601	H Bolt; 6mm-1.00 x 16mm Hex	6	07703	O Edge Trim	1	102503
B Hose Silicone	1	08622	I Washer; 1/4" Lock	3	08198	P Bracket; Sm. "L"	1	07805
C Intake Tube	1	087177	J Washer; 1/4"ID x 5/8"OD Flat	13	08275	Q Bracket; Med. "L"	1	070632
D Hose; 1/2"ID x 17"L, Silicone	1	08177	K Nut; 6mm Nylock	7	07553	R Bolt; 8mm-1.25 x 16mm Hex	1	07844
E Screw; M4-.7 x 12mm, B/H/A	2	07726	L Stud; M6 M/M Rubber MNTD	2	07027	S Washer; 8mm Wave	1	08239
F Spacer	2	06503	M Bracket; Lg. "L"	1	010051	T Washer; 5/16"ID x 5/8"OD Flat	1	08276
G Bracket	1	070106	N Heat Shield	1	07689	U Hose; Step Silicone	1	08051
						V Hose Clamp #56	1	08620
						W Adapter #380	1	21512
						X Hose Clamp #104	1	08697
						Y Air Filter	1	RF-1014

TO START:

1. Turn the ignition OFF and disconnect the vehicle's negative battery cable.



2. Disconnect the mass air sensor electrical connection and unhook the harness from the air box.



3. Remove the two bolts shown, which secure the engine cover.



4. Lift firmly on the engine cover to dislodge it from the mounting grommets, and then remove the cover from the engine as shown.

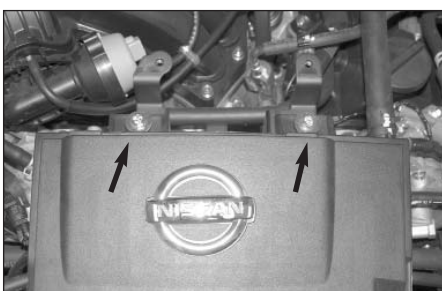

5. Remove the two bolts shown which secure the stock intake tube to the engine.

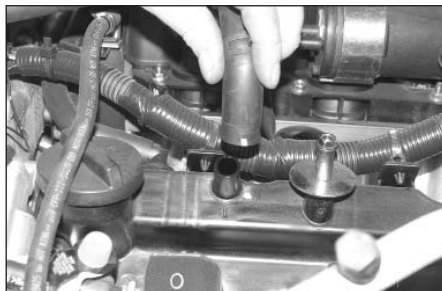

6. Using pliers, loosen the spring clamp which secures the crank case vent hose to the valve cover and then remove the hose from the valve cover as shown.



7. Loosen the two hose clamps shown which secure the stock intake tube to the air box and to the throttle body.



8. Remove the intake tube from the vehicle as shown.



9. Remove the air box retaining bolt shown.



10. Pull firmly on the air box to dislodge it from the mounting grommets and remove it from the vehicle.

NOTE: K&N recommends that customers do not discard your factory air intake.

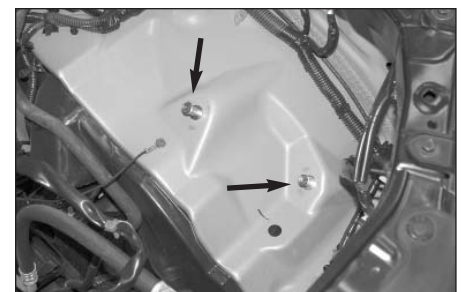

11. Remove the two air box mounting studs shown from the inner fender.

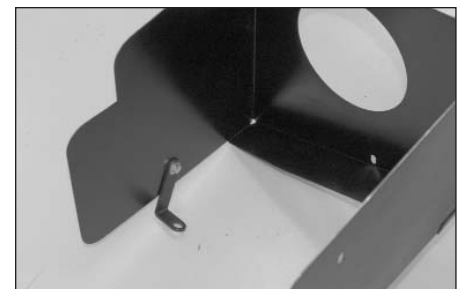

12. Install the "L" bracket (070632) onto the heat shield as shown with the provided hardware.

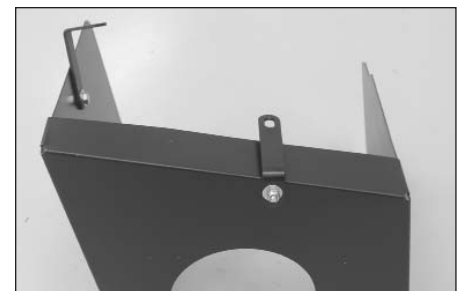

13. Install the "L" bracket (010051) onto the heat shield as shown with the provided hardware.

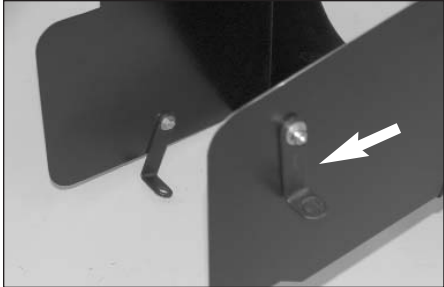

14. Install the "L" bracket (07805) onto the heat shield as shown with the provided hardware.



15. Install the edge trim onto the heat shield as shown.

NOTE: Some trimming of the edge trim may be necessary.



16. Install the provided rubber mounted studs onto the heat shield using the supplied hardware.



17. Secure the provided tube mounting bracket (070106) onto the rubber mounted studs using the provided hardware.



18. Remove the bolt, which secures the ground strap to the inner fender.

NOTE: This bolt will not be reused.

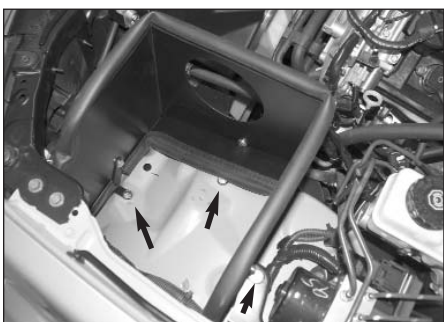

19. Install the heat shield assembly into the vehicle and secure with the provided hardware to the air box mounting locations.

NOTE: Secure the ground strap removed in step #18 with the lower heat shield mounting bracket.



20. Install the silicone hose (08622) onto the throttle body and secure with the provided hose clamp.



21. Remove the two screws, which secure the mass air sensor to the stock air box and then remove the mass air sensor from the air box.



22. Install the mass air sensor into the K&N intake tube and secure with the hardware provided.



23. Install the K&N intake tube into the silicone hose at the throttle body and align with the mounting bracket installed onto the heat shield. Secure the intake tube with the provided hardware.

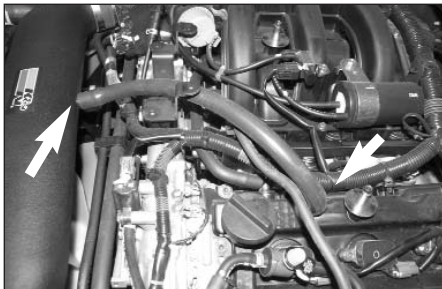

24. Attach the provided silicone crank case vent hose to the valve cover and the K&N intake tube as shown.



25. Install the filter adapter into the air filter as shown and secure with the provided hose clamp.



26. Install the silicone hose (08051) onto the air filter assembly as shown and secure with the hose clamp.



27. Install the air filter assembly onto the K&N intake and secure with the provided hose clamp.



28. Re-install the engine cover removed in step #4 and secure with the factory mounting bolts.



29. Reconnect the mass air sensor electrical connection.



30. Reconnect the vehicle's negative battery cable. Double check to make sure everything is tight and properly positioned before starting the vehicle.

31. It will be necessary for all Aircharger's to be checked periodically for realignment, clearance and tightening of all connections. Failure to follow the above instructions or proper maintenance may void warranty.

ROAD TESTING:

1. Start the engine with the transmission in neutral or park, and the parking brake engaged. Listen for air leaks or odd noises. For air leaks secure hoses and connections. For odd noises, find cause and repair before proceeding. This kit will function identically to the factory system except for being louder and much more responsive.
2. Test drive the vehicle. Listen for odd noises or rattles and fix as necessary.
3. If road test is fine, you can now enjoy the added power and performance from your kit.
4. K&N suggests checking the Air Filter element periodically for excessive dirt build-up. When the element becomes covered in dirt (or once a year), service it according to the instructions on the Recharger service kit, part number 99-5050 or 99-5000.