

PYLE®

PLTS73FX

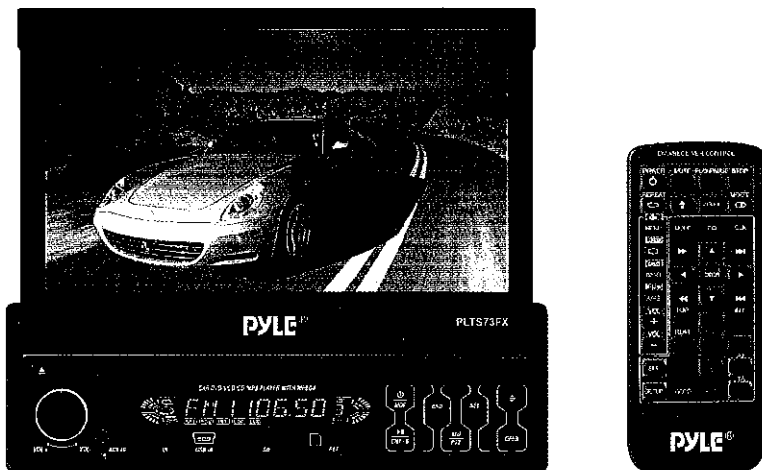

OWNER'S MANUAL

IN-DASH DVD/MP4/VCD/MP3/CD PLAYER
7 Inch Wide Color Touch Screen TFT Monitor
AM/FM-RDS Receiver
USB Port/SD Card slot And Front Panel AUX Input

Contents

Precautions	2	DISC Special Functions	26
Safety Information	3	Selecting Subtitles	26
Disc Notes	4	Selecting audio languages	26
Installation	5	Title menu function	26
Electric Connection	7	Setup	27
Remote Control	8	System Setup.....	27
Basic Operations	11	Languages Setup.....	29
Loading/Ejecting a DISC	11	Video Setup	30
Open/Close the Monitor	11	Digital Setup	31
Adjust the Angle of the Monitor	11	AUX Operations	32
FFT Monitor Adjustment	12	USB Operations	33
Getting the animation.....	12	SD/MMC Card Operations	34
Getting wallpaper.....	13	MP3/WMA/JPEG/MPEG4 Play	35
Audio Quality Adjustments	13	Specifications	36
Getting the Time	13	Trouble Shooting	37
Getting Audio Mode	14		
Reset Factory Settings	14		
Rear View Camera	14		
Alternate Audio Source.....	14		
Control Panel	15		
Unit keys (open position).....	15		
Touch sense keys (close position) ..	16		
Radio Operations	18		
Listening to the radio	18		
Storing stations in memory	19		
Listening to a preset station	19		
DIS Function.....	19		
DISC Operations	22		
Basic Operations	23		
Select Playback Mode	23		
On-Screen Disc Operations	25		

Precautions

THANK YOU FOR PURCHASING THIS CAR DVD PLAYER .

Before operating the unit, read this manual thoroughly and keep it handy for future reference .

To avoid injury or accident , read the following precautions before installing and operating the unit .

ON INSTALLATION

- DO NOT install any receiver in locations where;
 - it may obstruct the steering wheel and gearshift lever operations, as this may result in a traffic accident.
 - it may obstruct the operation of safety devices such as air bags, as this may result in a fatal accident.
 - it may obstruct visibility.
- DO NOT operate any receiver while manipulating the steering wheel, as this may result in a traffic accident.
- The driver must not watch the monitor while driving.
- IF THE DRIVER watches the monitor while driving, it may lead to carelessness and cause an accident.
- IF YOU NEED to operate the receive while driving, be sure to look ahead carefully or you may be involved in a traffic accident.
- IF THE PARKING BRAKE is not engaged." ParkingBrake" flashes on the monitor, and no playback picture will be shown.
 - This warning appears only when the parking brake wire is connected to the parking brake system built in the car (refer to the electric connection)

ABOUT THE LIQUID CRYSTAL DISPLAY (LCD) PANEL

Do not press on the LCD panel on the unit as doing so can distort the picture or cause a malfunction . The picture may become unclear , or the LCD panel may be damaged .

NOTES ON CLEANING

- Clean the LCD panel with a slightly damp soft cloth.
 - Do not use solvents such as benzine, thinner, commercially available cleaners or antistatic spray .
 - Do not use alcohol to clean the screen .
- If your car was parked in a cold or hot place, the picture may not be clear . The monitor is not damaged . The picture will become clear the temperature in your car becomes normal .

Safety Information

CAUTION:

THIS DVD PLAYER IS A CLASS I LASER PRODUCT. HOWEVER THIS DVD PLAYER USES A VISIBLE/INVISIBLE LASER BEAM WHICH COULD CAUSE HAZARDOUS RADIATION EXPOSURE IF DIRECTED. BE SURE TO OPERATE THE DVD PLAYER CORRECTLY AS INSTRUCTED.

USE OF CONTROLS OR ADJUSTMENTS OR PERFORMANCE OF PROCEDURES OTHER THAN THOSE SPECIFIED HEREIN MAY RESULT IN HAZARDOUS RADIATION EXPOSURE. DO NOT OPEN COVERS AND DO NOT REPAIR YOURSELF. REFER SERVICING TO QUALIFIED PERSONNEL.

WARNING:

TO REDUCE THE RISK OF FIRE OR ELECTRIC SHOCK, DO NOT EXPOSE THIS EQUIPMENT TO RAIN OR MOISTURE.

TO REDUCE THE RISK OF FIRE OR ELECTRIC SHOCK, AND ANNOYING INTERFERENCE, USE ONLY THE RECOMMENDED ACCESSORIES.

THIS DEVICE IS INTENDED FOR CONTINUOUS OPERATION.

This product incorporates copyright protection technology that is protected by method claims of certain U.S. Patents and other intellectual property rights owned by Macrovision Corporation and other rights owners. Use of this copyright protection technology must be authorized by Macrovision Corporation, and is intended for home and other limited viewing uses only unless otherwise authorized by Macrovision Corporation. Reverse engineering or disassembly is prohibited.

REGION MANAGEMENT INFORMATION:

This DVD Player is designed and manufactured to respond to the Region Management Information that is recorded on a DVD disc. If the Region number described on the DVD disc does not correspond to the Region number of this DVD Player, this DVD Player cannot play this disc.

Disc Notes

Disc formats supported by this player

DVD	<i>DVD</i>	Audio and Video Disc size 12 cm
VCD	<i>VCD</i>	Audio and Video Disc size 12 cm
CD	<i>CD</i>	Audio Disc size 12 cm
MP3	<i>MP3</i>	Audio Disc size 12 cm

Discs which cannot be played with this player

- DVD-RAM
- CDV
- CDG

Handling and Cleaning

- Dirt, dust, scratches and warping disc will cause misoperation.
- Do not place stickers or make scratches on discs.
- Do not warp discs.
- A disc should always be kept in its case when not in use to prevent from damaging.
- Do not place discs in the following places:
 1. Direct sunlight
 2. Dirty, dusty and damp areas
 3. Near car heaters
 4. On the seats or dashboard

Disc Cleaning

Use a dry soft cloth to wipe the surface. If the disc is quite dirty, use a soft cloth slightly moistured with isopropyl (rubbing) alcohol. Never use solvents such as benzine, thinner or conventional record cleaners as they may mar the surface of the disc.

Note:

A disc may become somewhat scratched (although not enough to make it

unusable) depending on your handle it and conditions in the usage environment. Note these scratches are not an indication of any problem with the player.

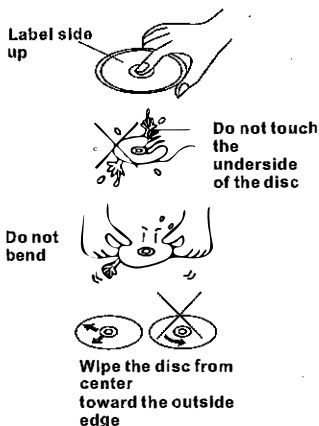

Preparing New Discs with Rough Spots

A new disc may have rough edges on its inside and outside edges. If a disc with rough edges is used, the proper setting will not be performed and the player will not play the disc. Therefore, remove the rough edges in advance by using a ball point pen or pencil as shown on the right. To remove the rough edges, press the side of the pen or pencil against the inside and outside edges of the disc.

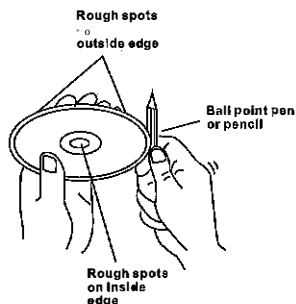

Installation

NOTES:

Choose the mounting location where the unit will not interfere with the normal driving function of the driver.

Before finally installing the unit, connect the wiring temporarily and make sure it is all connected up properly and the unit and the system work properly.

Use only the parts included with the unit to ensure proper installation. The use of unauthorized parts can cause malfunctions.

Consult with your nearest dealer if installation requires the drilling of holes or other modifications of the vehicle.

Install the unit where it does not get in the driver's way and cannot injure the passenger if there is a sudden stop, like an emergency stop.

If installation angle exceeds 30 from horizontal, the unit might not give its optimum performance.

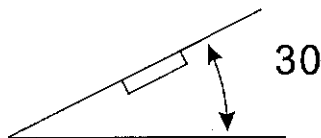

Avoid installing the unit where it would be subject to high temperature, such as from direct sunlight, or from hot air, from the heater, or where it would be subject to dust, dirt or excessive vibration.

DIN FRONT/REAR-MOUNT

This unit can be properly installed either from "Front"(conventional DIN Front-mount) or "Rear"(DIN Rear-mount installation, utilizing threaded screw holes at the sides of the unit chassis). For details, refer to the following illustrated installation methods.

Installation

Installing the unit

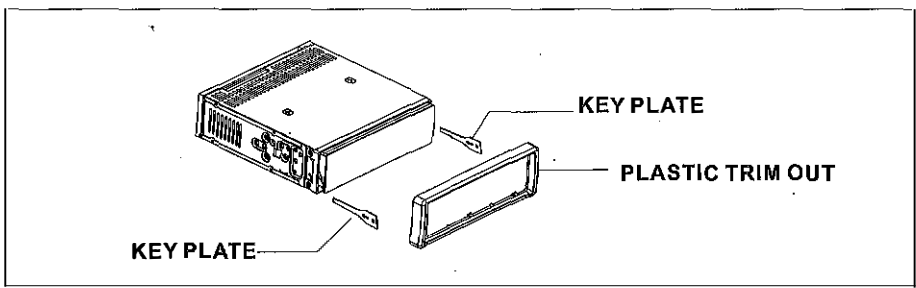
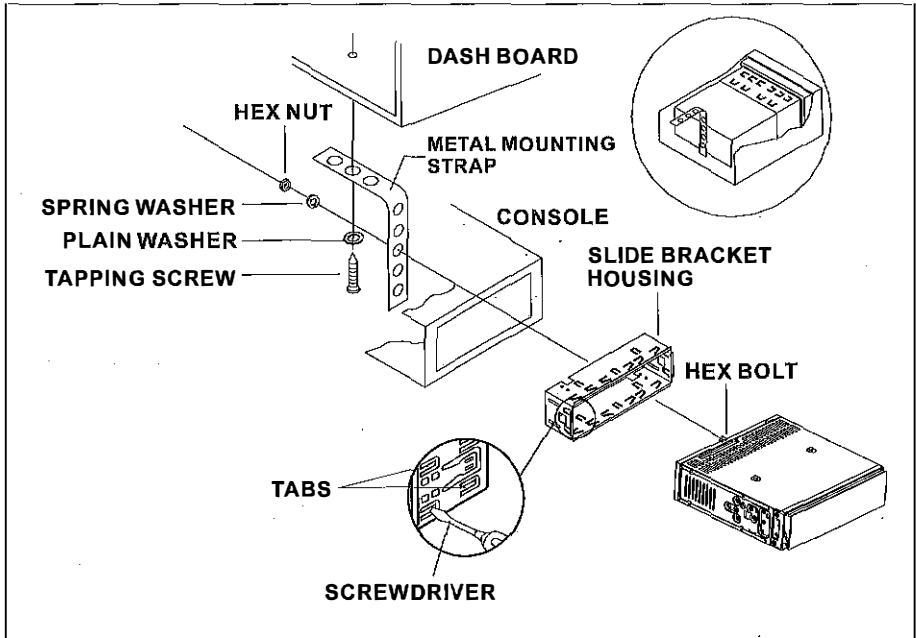

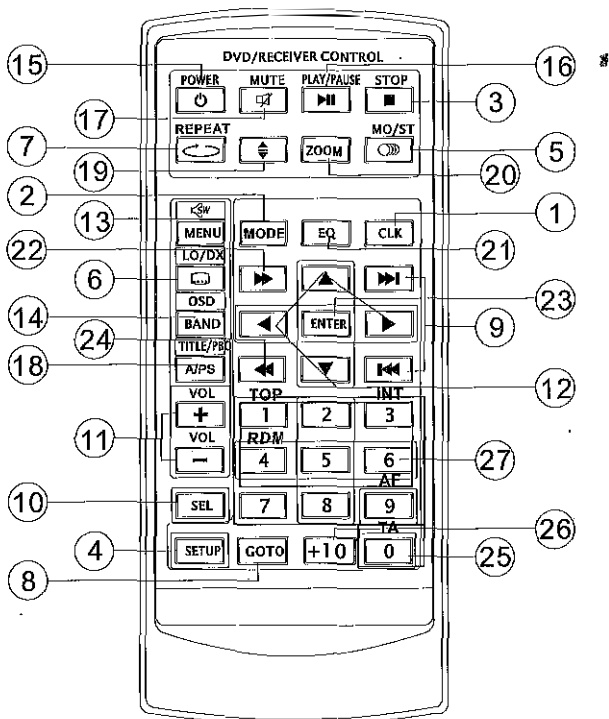

If you want to take CHASSIS out of the SLIDE BRACKET HOUSING, first remove the PLASTIC TRIM OUT of the both sides away, then insert the two KEY PLATE into left and right side of chassis as above illustration.

Remote Control



Ref #	Button	Function
1	CLK	Press it briefly to view the clock time , Press again to return to normal display mode .
2	MODE	Press it to select the input mode, such as DVD, RADIO, etc .
3	STOP	Press once to pause playback. Press PLAY/PAUSE to resume playback. Please note: if you press STOP twice, playback will start at the beginning of the disc.
4	SETUP	Press this button to open the SETUP menu.
5	MO/ST (AUDIO)	In Radio mode, press this button to change between Mono and Stereo reception modes (when a station is weak, sometimes switching to Mono will improve sound quality). In Disc Playback mode, pressing this button opens the AUDIO setup menu for making changes to the way the soundtrack is reproduced.
6	SUBTITLE LOCAL/ DISTANT	In DVD Disc Playback mode, pressing this button will allow you to change the subtitle language on discs which have this as an option. In Radio mode, press this button to change the radio reception sensitivity in stations are near or far.
7	REPEAT	Pressing the button will open a menu presenting you with the playback repeat options available for that kind of disc .

Remote Control

Ref #	Button	Function
8	GOTO	Press it button to begin playback at a moment in the program you designate. Use number buttons to enter the data that is needed.
9	▶▶ / ◀◀	Press these buttons to skip ahead or back one track.
10	SEL	Press this button repeatedly to cycle through the various audio and video adjustments you can make: Volume, Bass, Treble, Balance, Fader, Color, Brightness, Contrast and Tint.
11	VOL +/-	Use these controls to adjust the volume level.
12	◀ / ▶ / ▲ / ▼	Press to navigate the various menus present in the product.
13	Menu SubWoofers ()	Press this button briefly to display the root level directory of a DVD disc. Press and hold this button to turn on or off the SUBWOOFER output.
14	BAND (OSD)	In Radio mode, press this button repeatedly to switch between the five radio bands: FM1 > FM2 > FM3 > AM1 > AM2. In Disc Playback modes, Press this button to see information about the disc currently in play.
15	 POWER	Press this button to turn the unit ON, press it again to turn the unit OFF.
16	PLAY/ PAUSE	In Disc Playback mode, press to pause playback. Press again to start where playback stopped.
17	MUTE	Press this button to turn off the audio. Press again to restore the sound to its prior volume level.
18	TITLE/ PBC(A/P)	Display the TITLE menu that is stored in DVD disc changing between PBC ON and PBC OFF on the VCD disc. In Radio mode, press and hold this button to start the Auto-Program mode, during which the tuner will scan for all strong stations and assign them to the radio preset buttons.
19		Press this button to Open/Close the operate monitor. Long press it to adjust the angle of monitor Upward/Downward
20	ZOOM	Shortly press it to increase the picture in size.
21	EQ	Press repeatedly to cycle through the different equalizer curve presets you may wish to use for enhanced listening.
22	▶▶	In Disc Playback mode, press for fast forward playback.

Remote Control

Ref #	Button	Function
23	ENTER	This button is used to confirm selections and settings within many of the menus in the OSD system.
24	◀◀	In DISC mode, press it to reverse rapidly
25	0-9	Use to input numerical values during programming, with the GOTO button, or to directly select a track to play . In Radio mode, (when the RDS engaged,) 0 serves as TA function, 9 serves as the AF function .
26	+10	This button is used with the other number buttons for use with two-digit number entries.
27	1-6	Six numbered preset buttons store and recall stations for each band

Preparing the Remote Control

Inserting the Battery

1. First push to inside as the direction indicated by the arrow (See ①) And then Remove the battery holder as the direction indicated by the arrow (See ②).
2. Replace the battery Set a new battery property with (+) side up as illustrated (See ③).
3. Insert the battery holder. Push in the holder to the original position (See ④).

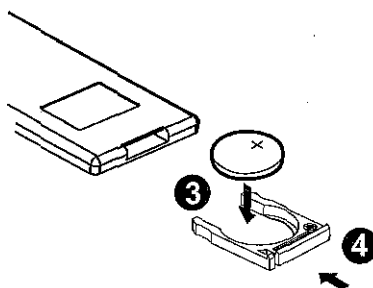
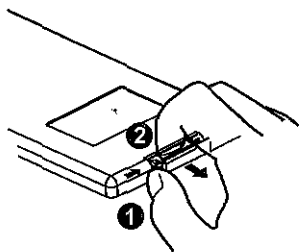

Using the Remote Control

Face the remote control towards the player front face IR mark (remote control signal receiver).

Operation angle: About ± 30 degree in each the direction of the front of the IR mark.

Note :

The lithium cell in the battery compartment of remote control has been secured for transport with a foil . Before initial use please remove this foil so that the remote control is ready for operation .

Basic Operation

POWER ON/OFF

 Touch the "OFF" ICON on screen to turn the unit off. Press the "ON" on the front panel to turn it on, press it again to turn off.

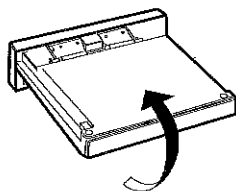
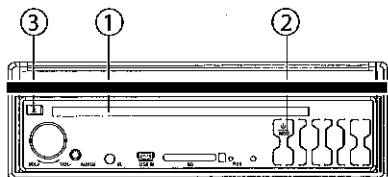



FIG.2

LOADING/EJECTING A DISC

Loading a Disc

1. Press the POWER (2) button to turn the device on.
2. Insert the disc with printed side facing up into the disc slot (1).
3. The player starts playback the disc automatically.



- Adjusting the viewing angle.
When the monitor does not move, you press  button on the panel to turn the monitor upward or downward at fine steps to get a desired viewing angle.

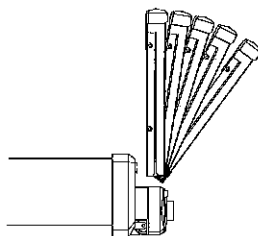



FIG.3

Ejecting a Disc

In DVD mode, Press the  (3) button on the front panel to eject the disc.

Do not rotate the monitor forcibly to avoid mechanical damage.

OPEN/CLOSE THE MONITOR AND ANGLE ADJUSTMENT

- Touch OPEN button on front panel, the monitor will draw out automatically.

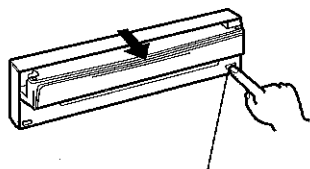

FIG.1

OPEN/CLOSE button

When the monitor draws out to a certain location, it will turn upward automatically and stop at vertical position.

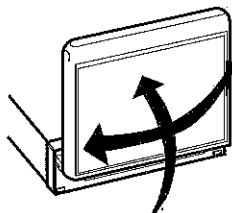

FIG.4

- Return the monitor to the central viewing position, then press OPEN button on the front panel, the monitor will turn downward automatically.

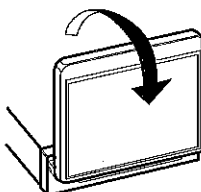

FIG.5

Basic Operation

- When the monitor turns downward to a certain angle, it will draw in .

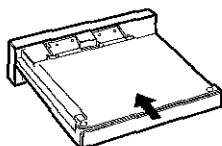

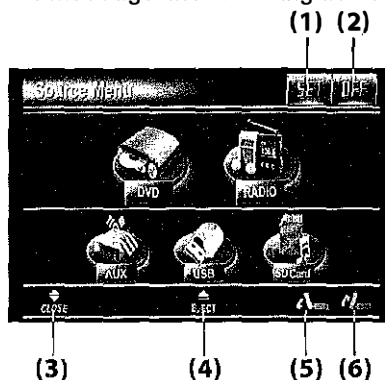





FIG.6

TFT Monitor Adjustment

In Radio modes, touch the "RADIO" icon or In DVD mode , touch the  range to enter the home menu, the message like following as below.



- SET** button
touch to enter the SETTING mode .
- OFF** (Power) button
in any modes, touch the " OFF " ICON to switch the unit off . .
-  Button
Touch to open/close the monitor .
-  Button
Touch eject the disc form the disc slot.
-  Button
to adjust the angle of monitor downward until your desired angle .
-  Button
to adjust the angle of the monitor upward until your desired angle .

Touch the "SET" ICON on touch screen to enter the setting mode, the message will display like following :
to return to the previous playback

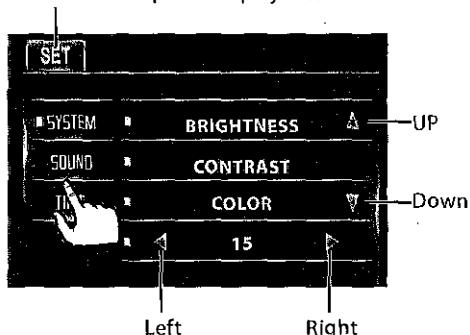

Touch "SYSTEM" on the setting menu, touch the "▲ / ▼" ICONS to select the adjustment item, touch the "◀ / ▶" ICONS to adjust the selectment item, it depends on your habit to setup the data.

ADJUSTABLE ITEMS:

CONTRAST: 0 to 32

Adjust the contrast of the bright and dark portion.

COLOR: 0 to 32

Adjust the color for the picture-lighter or darker.

BRIGHT: 0 to 32

Adjust If the picture is too bright or too dark.

TINT: 0 to 32

Adjust the tint if the human skin color is unnatural.
-Adjustable when "NTSC " is selected for "NTSC/PAL " .

ANIMATION

In **RADIO** mode, you can change the playing time of animation among of "10SEC, 30SEC, 60SEC, 90SEC, 2MIN, 3MIN, 4MIN and OFF " .

Note:

Please set the playing time of the animation to "10SEC" for the first, when you turn the unit on .

Basic Operation

WALLPAPER

In SETTING mode, touch the "SYSTEM" range to select the wallpaper mode .

in wallpaper mode, you can select the among of "Yellow, Red, L Blue, D Blue, Purple, Green, AUTO" .

When you select the "AUTO" item, the player will change the background automatically .

AUDIO QUALITY ADJUSTMENT

In Radio modes, touch the screen of the "RADIO" ICON to enter the home menu, touch the "SET" ICON to enter the Setting mode, the message will display on the screen :

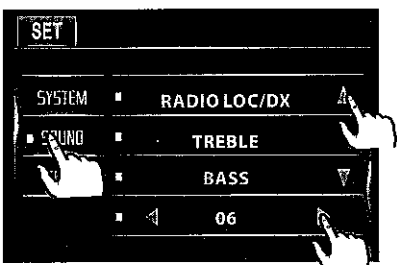

Touch the "SOUND" section on the setting menu, touch the "◀ / ▶" ICONS to select the adjustment item, touch the "▲ / ▼" ICONS to adjust the selection item , It depends on your habit to select the Audio mode . Then touch the "SET" icon to return to the previous playback .

ADJUSTABLE ITEMS:

TREBLE: -7to +7

Adjust treble level .

BASS: -7 to +7

Adjust bass level .

BALANCE: R 0-10 to L 0-10

Adjust sound balance between left and right speakers .

FADER: F 0-10 to R 0-10

Adjust sound balance between front and rear speakers .

SUB-WOOFER SET

Touch to switch the subwoofer function ON and OFF .

BUZZER SET

Touch to switch the BUZZER BEEP function ON and OFF .

SETTING THE TIME

In SETTING mode, touch the "TIME" range to select the time mode .

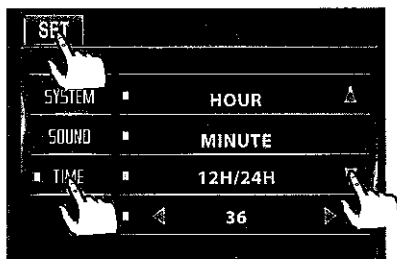

Touch the "TIME" section on the setting menu, touch the "▲ / ▼" ICONS to select the adjustment item, touch the "◀ / ▶" ICONS to adjust the selection item, then touch "SET" icon to confirm. It's depend on your need to setup the data.

ADJUSTABLE ITEMS:

Hour adjustment: 0-23

Minutes adjustment: 0-59

Time format selection : 12H/24H

Basic Operation

Setting Audio Modes

In any modes, touch the "EQ" range on the touch screen (or press the EQ button on remote control) to select one of the preset sound modes: ROCK/POP/JAZZ/CLASSIC/USER .

EX.: In RADIO mode

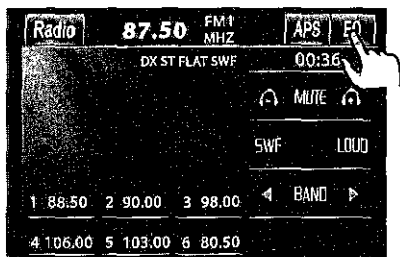

The information will display in the monitor as follow :

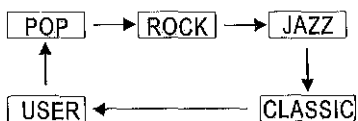

It depends on your habit to select the Audio mode .

Reset Factory Settings

RESET button is placed on the panel and must be activated with either a ballpoint pen or thin metal object.

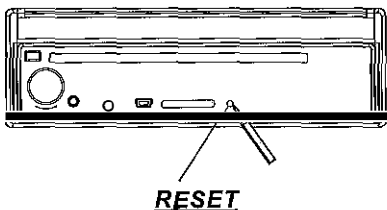

The RESET button is to be activated for the following reasons:

- A. Initial installation of the unit when all wiring is completed.
- B. All the function buttons do not operate.
- C. Error symbol on the display.

Rear View Camera

When connecting the rear view camera the mirror image of the rear view is automatically displayed on the monitor when you change the gear to the back position.
(Note: additional monitor can not display the image.)

ALTERNATE AUDIO SOURCE

On the front panel of the unit , there is an AUX IN jack, to connect analogue replay devices. Use this jack to replay sound of other replay equipment such as DVD players, computers, etc. Via the loudspeakers.

- 1). Please following the diagram below, connect the external device with stereo jack plug the AUX IN socket .
- 2). Press the MOD button to select the AUX IN connection.
- 3). Use the buttons on the external device itself to operate it .

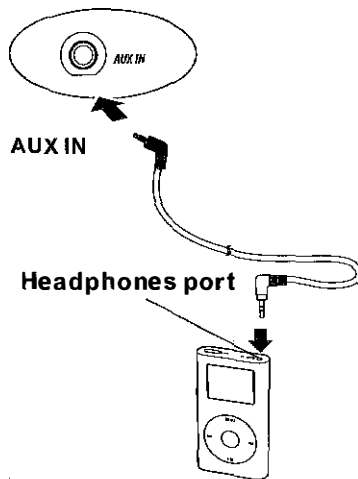

Control Panel

UNIT KEYS

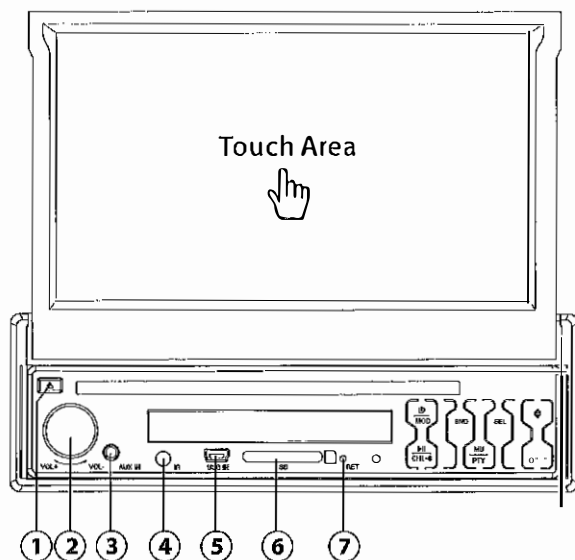

- ① ▲ (EJECT)**
Insert the disc, label side facing up, until the mechanism senses its presence and draws the disc in. Press to eject the disc.
- ② VOL-/VOL+ BUTTON**
In normal mode, this button is used to adjust the volume to desired level. It is also used as an UP/DOWN button when audio or video settings are being adjusted when accessed using the SELECT button.
- ③ AUXILIARY INPUT JACK**
Insert an external device to this AUX jack in order to have audio output of the device through the unit.
- ④ IR SENSOR**
- ⑤ USB OPERATION**
For information about connecting a USB device, please see USB operation..
- ⑥ SD CARD SLOT**
For information about connecting a SD/MMC device, please see SD operation
- ⑦ RESET BUTTON**
Press this button to return to factory settings.

Control Panel

UNIT KEYS

(touch sensitive control)

8

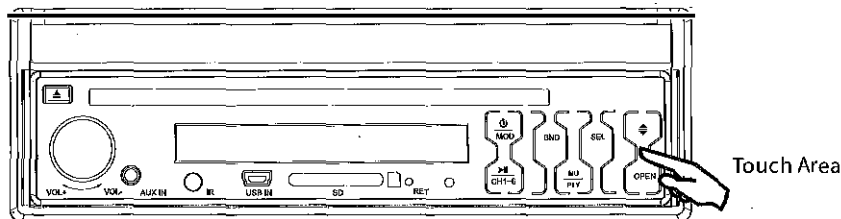

⏻ (POWER On/Off)/MODE

Touch this button to switch the device on. WELCOME appears in the display. Touch it again to switch the device off. SEE YOU appears in the display. In playback mode, you can touch this range to select the input mode by touching repeatedly until the proper one is found :
DISC > AUX IN > RADIO .



BAND

Touch to switch between the 3FM and the 2AM(MW) bands. The designation of the corresponding level - **FM1, FM2, FM3, AM1(WM1), AM2(MW2)** - is shown in the TFT.



SEL SELECT BUTTON

To access the available adjustment settings for audio and video, touch repeatedly to select them as follow: BASS, TREBLE, BALANCE, FADER, COLOR, BRIGHTNESS, CONTRAST, TINT, VOLUME etc. Then rotate the VOL + / - to adjust the selected mode. Repeatedly Long press the SEL button more then 2 seconds to select them as follow: LOUDNESS, SUBWOOFER, EQ, LOC/DX, ST/MO, TINT, TIME, BUZZER, USA/EUROPE FREQUENCY, ANIMATION, WALLPAPER etc. Then rotate the VOL + / - to adjust the selected mode. Note: Rotate the VOLUME knob to select the item.



⤴ ANGLE (Screen position)

When the monitor does not move, you touch it button on the panel to turn the monitor upward or downward at fine steps to get a desired viewing angle.

Control Panel



▶ (PLAY/PAUSE) / CH 1-6 (RADIO PRESET)

A) In Disc Playback Mode

Touch this button to pause playback, touch again to resume playback.

B) In Radio Mode

Touch repeatedly to preset station. With this system a total of 30 stations can be stored in the memory. Each band store up to six preset stations. The stations might be FM1, FM2, FM3, AM1 (MW1) and AM2 (MW2) band.

The operation as below:

-Store in Memory

> Select the frequency band.

> Touch repeatedly this range to select the desired memory key.

> Select the station.

> Keep the desired memory key touched in until the station is heard again after a brief interruption.

-Retrieve a preset station

Touch repeatedly to retrieve a station which had been stored in the memory in advance the chose number is shown on display.



MU/PTY

Touch the button to switch of the loudspeakers for a short period.

The word MUTE flashes in the display. Press it again to cancel the mute function. This function can also be cancelled by rotating the VOL multifunction button.

In Radio Mode, press this button and hold for a bout 2 seconds to select the PYT of the program type (examples of such types of program are : NEWS, POP.....)



OPEN

Touch to open/close the monitor of the unit.

Touch Screen Operation

RADIO MODE

Touch the RADIO ICON in home menu to enter the RADIO mode:

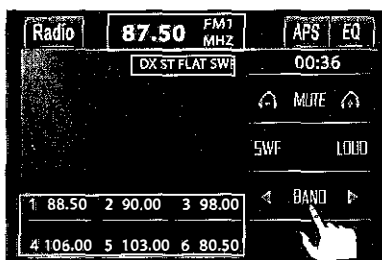
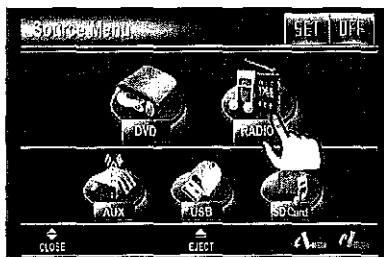

Selecting The Frequency Band

Touch the screen of "BAND" section repeatedly to select the band, the message will show in turn:

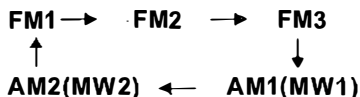

When an FM stereo broadcast is hard to receive

Press **ST/MO** button on the remote control to select the MONO or STEREO mode. (When Stereo mode is activated, the ST symbol will appear.)

Start Searching For a Station

Manual Search

During Radio mode, briefly touch "▶" to increase frequency by one step of channel spacing.

Briefly touch "◀" to decrease frequency by one step of channel spacing.

Automatic Search

During Radio mode, touch and hold (for more than 2 seconds) either "◀ / ▶" ICONS to start search for a radio station automatically.

To tune in strong-signal FM Station only (LO/DX function)

In home menu, then touch the "SET" icon to enter the setting menu, the message will display as below:

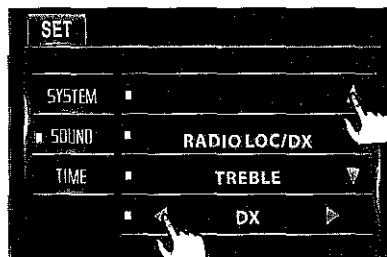
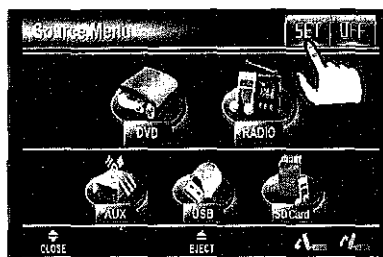

Touch the "SOUND" section on the setting menu, touch the "◀ / ▶" ranges to select the "Radio L/D" item, touch the "▲ / ▼" ranges to choose between the LOC and DX mode of Local and Long-distance traffic news.

Touch Screen Operation

Storing Stations In Memory

Setting Memory

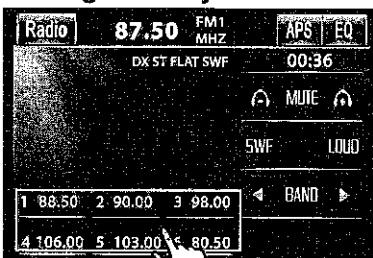

With this system, a total of 30 stations can be stored in the memory of six buttons. Each band stores up to six preset stations. The stations might be FM1, FM2, FM3, AM1(MW1), and AM2(MW2) band.

The operation is as below :

Store in Memory

- >Select the frequency band
- >Select the station
- >Keep the desired memory key pressed in until the station is heard again after a brief interruption .

Retrieve a preset station

Touch the 1-6 ranges briefly to retrieve a station which had been stored in the memory in advance the chose number is shown on display .

Automatic Memory Storing & Program Scanning

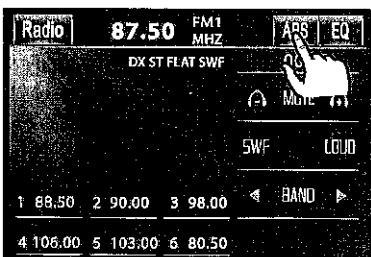

Automatic Preset Setup

In Radio Mode, touch and keep (for more than 2 ' S) the screen of " APS " range to active automatic station storage.

The radio searches within the current frequency band, e.g. FM1, for the stronger signal level until the search cycle has finished . The six strongest stations are then allocated to the corresponding storage locations .

Then the station of the first storage location is set .

Scan Function

In Radio mode, briefly touch the " APS " section on the touch screen , the radio briefly plays all the preset stations of the frequency band .

RDS FUNCTION

In Radio mode, touch the " RADIO " ICON to enter the main menu, then touch the " SET " ICON to enter the set mode, the message in the display : (only in the " TA ON " mode.)



Touch the " RDS " section on the setting menu, touch the " < / > " ranges to select the adjustment item, touch the " ▲ / ▼ " ranges to adjust the selectment item , It ' s depend on your need to select the different function . Then touch the " SET " range to return to the previous playback .

Touch Screen Operation

ADJUSTABLE ITEMS:

REGION SET

Touch to switch the REGION function ON and OFF .

PISET

Touch to change between PI MUTE and PI SOUND .

REG FUNCTION

at certain times some stations divide up their programs into regional programs with varying content .

REG ON: the message "REG ON" will appear in the display for a few seconds .

Note :

- the display capacity is limited . It is possible that in the double display mode some segments of the display are deleted .

- the function REG ON prevents the radio from switching to alternative frequency which have a diferent regional program content .

REG OFF: the program identification (PI) of the regional program is ignored during the search for an alternative frequency (AF) or a program identification (PI) .

PI MUTE / PI SOUND

(only for radio operation)

if you are in an area where two program identifications (PI) overlap, you can select the option **PI SOUND** and **PI MUTE** for playback of the sound. Alternate switching of the program identification should be avoided .

PI SOUND :

if switching nevertheless occurs the sound of another station is heard for less than one second .

PI MUTE:

the sound of another station is suppressed .

TA Traffic Announcement

(Priority For Traffic Information)

In Radio mode, touch the cursor button to switch the TA function ON and OFF .

When the TA function is activated, the TA symbol appears in the display .

During radio operation in one FM frequency band the search for a traffic announcement station is started automatically (TASEEK) .

If an FM station is being received which transmits the latest traffic announcements from time to time, the TP display lights up.

When the TA function is switched on , the FM traffic automatically interrupt CD operation (the word **TRAFFIC** appears in the display).

The volume level is increased to the minimum value for the transmission of traffic announcements.

After the traffic announcements has finished, the program that was previously running is resumed.

Interruption of the TA Function:

if you would like to interrupt the current traffic announcement, touch the TA section on screen briefly . This does switch off the TA mode .

AF FUNCTION

(Alternative Frequencies)

In Radio mode, touch the cursor button to switch the AF function ON and OFF .

AF is a function that works with the help of RDS (Radio Data System) and can only be used with FM stations . The radio searches in the background for the best frequency reception of the station that has been tuned into .

Touch Screen Operation

Touch the AF section on touch screen or swing and keep the SEL knob in the TA/AF direction for about 2 seconds , the AF function is activated. The AF symbol appears in the display .

When the AF function has been switched on, the radio continuously tests the signal strength of the AF frequency . The test interval for each AF frequency depends on the signal strength of the current station and varies from a few minutes in the case of weak signals . Whenever the new AF frequency is stronger than the station that is currently tuned in , the radio switched to this frequency for a short time for a short time and the message "NEW FREQUENCY " is displayed for one or two seconds.

Note :

the status of the AF function is shown by an AF symbol in the display.

- If the AF symbol appears in the display, the AF function is switched on and RDS transmission data is being received .
- If the AF symbol flashes in the display, the AF function is selected but no RDS signal can be received at the moment .

PTY FUNCTION

In Radio mode, touch screen of "PTY" range to select the Program type .

In Radio mode, touch screen of "PTY" range to select the Program type .

PTY Selection of the program type

besides the stations name, some FM stations also transmit information on the type of program. This information can be displayed by your car radio .

Examples of such types of program are :

SPORT NEWS POP WEATHER

With PTY function you can specifically select stations transmitting a particular type of program. Touch the PTY range on screen repeatedly to call up the PTY selection menu . The message "PTY SEEK" then appears briefly in the display .

When PTY has been selected the radio starts searching for corresponding PTY information and stops when the PTY information has been found, "NO PTY" appears in the display. If the PTY information being searched for no longer exists, the PTY function automatically switches to normal mode .

Touch Screen Operation

DVDMODE

In any modes, press the MODE button on the front panel to enter the DVD play mode . The message will display as below :

(When Parking Brake supplied)





 Mute function

 To decrease the volume level

 To increase the volume level

 To enter the main menu

 Random Function

 Repeat Function

 Intro Function

 Next menu

 To search fast forward

 To search fast backward

 Stop

 Play/Pause the disc

 To skip the next track

 To skip the previous track

 To search the disc with numbers



 In DVD mode, touch to display the root menu.

 In DVD mode, touch to display the title menu . In VCD mode, touch to switch the PBC ON and PBC OFF.

 To show/hide the Subtitle (depending on the DVD)

 To change the AUDIO setting (depending on the DVD)

 ZOOM IN and OUT

 To select the Equalizer mode

 To display the SETUP menu

 On screen- display

 To show / hide the clock

 Loudness Function



 Subwoofer Function

 Previous menu



Touch Screen Operation

BASIC OPERATION





Stopping Play

 Touch  ICON to stop the unit playback. Touch  to start play.

Pause (still picture)

 Touch  during playback to temporarily pause play. Touch again to return to normal playback.



Rapid Forward/Rapid Reverse

 During DISC playback, touch  /  for rapid forward/reverse.
 The speed of rapid forward/reverse changes according to the disc as follows:

DVD/VCD/CD/MP3:

Normal Playback 2x → 4x → 8x → 20x

Skipping Track

 During DISC playback, touch  /  to skip to next/back one track.

Note :

For some VCD2.0 disc (PBC-playback control), above these buttons may be unavailable.

Zoom Function

 Repeatedly touch for zoom-in/zoom-out rates as follows:
"zoom 2, zoom 3, zoom 4, zoom 1/2, zoom 1/3, zoom 1/4, zoom off."

Use the direction keys (▲ / ▼ / ◀ / ▶) on remote control to move the enlarged picture.

Note:

when the JPEG disc playback, in normal mode, you can use the cursor buttons to rotate the picture .
Press UP to invert an image .
Press DOWN to mirror an image .
Press LEFT to rotate an image to left .
Press RIGHT to rotate an image to right .

SELECTING THE PLAY MODES

During the Disc playback, touch the "RPT, RDM, INT" range to select the different playing mode .

1). REPEAT FUNCTION

FOR DVD :

Touch the screen the of "RPT" range (or press longer RPT button on the remote control) to select REPEAT mode as follow :

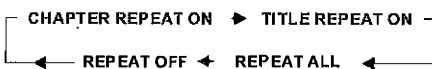

FOR VCD/CD/MP3 :

Touch the screen the of "RPT" range (or press longer 2/RPT button on the remote control) to select REPEAT mode as follow :



1. Continuously repeat at the current chapter/track, when selected REP-ONE mode .
2. Select REP-ALL mode to continuously repeat all chapter/track on the current disc .

2). INTRO FUNCTION

FOR CD :

Touch the screen of the "INT" section (or longer press the 3/INT button on the remote control) to play the previous 10

Touch Screen Operation

seconds part of each track/chapter on disc.

(Touch it again to cancel this mode)

FOR VCD :

Touch the screen of the "INT" section (or longer press the 3/INT button on the the remote control). It display will following menu as below :

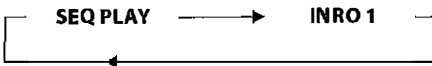

Note: when select the INRO Mode, this player to start to play the previous 10 seconds part of each track/chapter on disc. (Touch it again to cancel this mode .)

FOR DVD/MP3 :

For DVD/MP3 , press the INT button is not available .

3). RDM (RANDOM) FUNCTION

During DISC playback , touch screen of "RANDOM" section (press the 4/RDM button longer on the remote control to play in random. Each playing, the order is different . (Depend on the disc used for VCD).

Touch it again to cancel this function .

Note : in random mode, the ⏮ button is not available .

4). TOP FUNCTION

For DVD/VCD/CD/MP3:

In the state of DVD/VCD/CD/MP3 disc playing, press the 1/TOP button on the remote control to select the first track/ chapter to play.(depend on the disc used for VCD)

DISC Search (GOTO)

FOR DVD :

Touch the screen the of "GOTO" range the screen will display the following message :

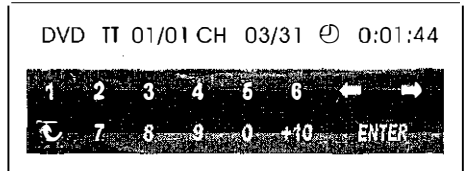

Touch the ◀ / ▶ to select the your adjustment item, then select the item you want to watch through CHAPTER/ TIME setting by touching the numeric buttons , then touch the ENTER button to confirm .

FOR VCD (With PBC OFF):

Touch the screen the of "GOTO" range , the screen will display the following message :

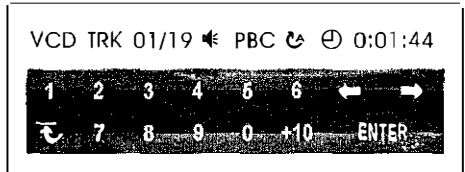

Touch the ◀ / ▶ to select the your adjustment item, then select the item you want to watch through TRACK/TIME setting by touching the numeric buttons , then touch the ENTER button to confirm .

Touch Screen Operation

ON-SCREEN DISPLAY FUNCTION

OSD



During playback, touch the screen of the OSD section, it will display the following as below :

1. DVD:

A. Touch or Press **OSD** for first time:

DVD TT 01/01CH 04/31 C 0:02:06

Title Number, Total Title Number, Chapter Number, Total Chapter Number of this Title of the disc currently being played will be shown on the screen, along with the elapsed time.

B. Touch or Press **OSD** for second time:

⏪ ½ ENG ■ 2CH ■ OFFAN OFF

C. Touch or Press **OSD** for third time:

DVD TT 01/01CH 04/31 C -0:01:32

D. Touch or Press **OSD** for fourth time:

DVD TT 01/01CH 04/31 T 0:16:00

E. Touch or Press **OSD** for fifth time:

DVD TT 01/01CH 04/31 T -1:36:55

F. Touch or Press **OSD** for sixth time:

The message on the screen will be cleared.

2. Example for VCD/SVCD/CD:

A. Touch or Press **OSD** for first time:

VCD TRK 1/19 ◀ PBC ⌂ C 0:01:36

B. Touch or Press **OSD** for second time:

VCD TRK 1/19 ◀ PBC ⌂ C -0:06:06

C. Touch or Press **OSD** for third time:

VCD TRK 1/19 ◀ PBC ⌂ T 0:02:12

D. Touch or Press **OSD** for fourth time:

VCD TRK 1/19 ◀ PBC ⌂ T -1:23:06

E. Touch or Press **OSD** for the fifth time:

The message on the screen will be cleared for SVCD and VCD.

NOTE:

For CD(audio) Disc, touch OSD button is not available .

3. Example for MP3

A. Touch or Press **OSD** for first time:

CDrom TRK 2/76 ◀ ⌂ C 0:00:36

B. Touch or Press **OSD** for second time:

CDrom TRK 2/76 ◀ ⌂ C 0:03:38

C. Touch or Press **OSD** for third time:

The message on the screen will be cleared.

Touch Screen Operation

DVD/VCD Special Function

1. Multi-subtitle Language Function (for DVD Only)



During DVD playback. Touch the **SUBTITLE** section on touch screen (or press the SUBTITLE on the remote).

Each time the button is pressed or touch, number of the subtitle language changes in sequential order.

Notes:

- The language number is different according to the disc.
- Some discs only contain one subtitle language.
- When no different subtitle language are recorded, "INVALID KEY" will be displayed at screen left top corner.

2. Multi-Audio Language Function



For DVD:

During DVD playback, touch the **AUDIO** section on touch screen (or press the AUDIO

on the remote.) Each time the button is pressed or touch, number of the audio soundtrack language changes on sequential order.

Notes:

- The language number is different according to the disc.
- Some disc only contain one language soundtrack
- When no different language soundtrack are recorded "INVALID KEY" will be display at screen left top corner.

ForVCD/CD:

during playback, touch the **AUDIO** section of the touch screen or Press **AUDIO** on the remote. It is possible to switch the sound between monaural and stereo sound.

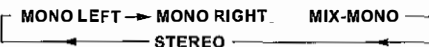

3. Title Menu Function

For DVD:

If the DVD has multiple titles recorded on the disc. It can select preferred title from the title menu to start playback.

- During DVD playback, press TITLE button on the remote. The title menu is display.
- Select preferred title by the cursor button and confirmed by press the ENTER button.

ForVCD:

Press **TITLE/PBC** button on the remote control while the disc is playing, you can switch between "PBC ON" and "PBC off" mode.

Touch Screen Operation

DVD SETUP

USING THE MENU

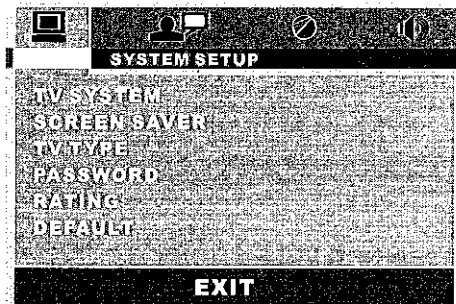

1. Touch the screen of " " range or press the **SETUP** button on remote .
2. The SETUP menu is displayed.
3. Touch directly the desired item to select the preferred item .
Or by using the ► / ◀ / ▼ / ▲ buttons .
4. Touch the **EXIT** section to clear the setup menu or press the **SETUP** on the remote control .

Overview Of The Main Menu

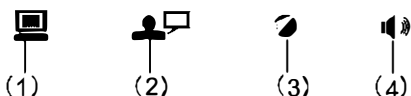

- (1). System Settings
- (2). Language Settings
- (3). Video Settings
- (4). Digital Settings

SYSTEM SETUP

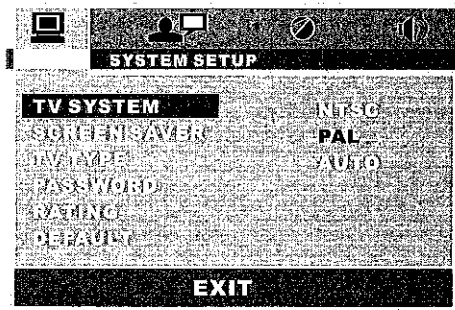

TV TYPE SETUP

This player is capable of playing discs recorded in either PAL or NTSC formats. Make the selection based on whether you are connecting the unit to a PAL TV or an NTSC TV. You can also set the unit to AUTO (autoselect). The disadvantage to autoselect is that each time you turn the unit on it checks to see what kind of monitor is connected, which causes a small delay and some flickering of the display image which you may find unpleasant.

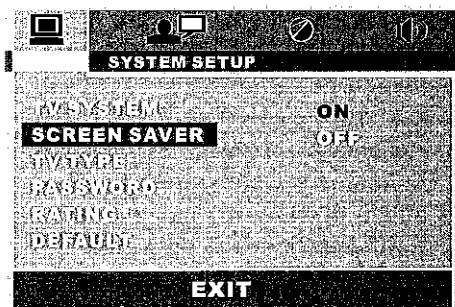

SCREEN SAVER SETUP

If the screen displays a static image for too long, some "burn-in" may occur, leaving a permanent trace of the image behind. To avoid this, turn ON the SCREENSAVER item. After a short period of inactivity on the monitor, the unit will substitute a moving image to avoid burn-in.

Touch Screen Operation

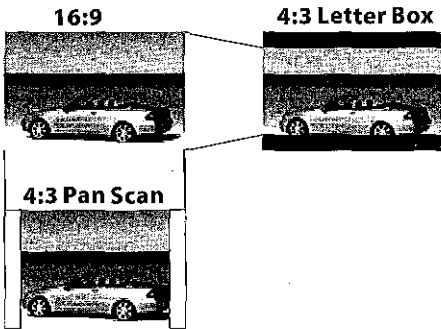
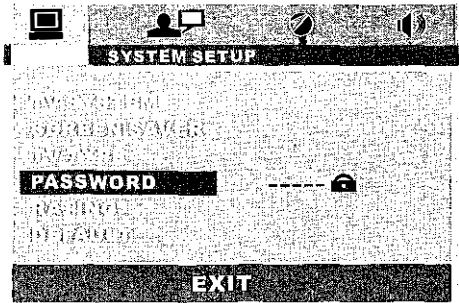
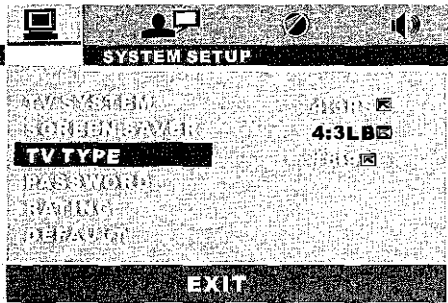

PASSWORD SELECTION

The password must be used to make changes to the Parental Control menu below. The factory default password is **0000**. You will be asked for the current password. Key in "0000" and press the ENTER on the remote control. Once you have entered it, you have the opportunity to change it and enter your new password. Then when you enter the Parental Control menu, you can make any changes.

TV DISPLAY SETUP

This is to select the appropriate TV aspect (4:3 or 16:9) according to the connected TV set.

Normal/PS (For 4:3 TV)

Played back in the PAN & SCAN style. (If connected to wide-screen TV, the left and right edges are cut off.)

Normal/LB (For 4:3 TV)

Played back in LETTER BOX style. (If connected to wide-screen TV, black bands appear at top and bottom of the screen.)

Wide (For 16:9 TV)

Select when a wide-screen TV set is connected.

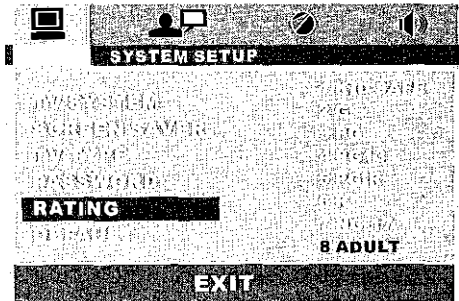

RATING

Select suitable parental guidance with the cursor buttons and confirm it by pressing the ENTER button.

Touch Screen Operation

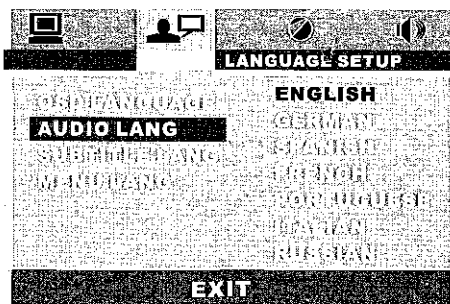
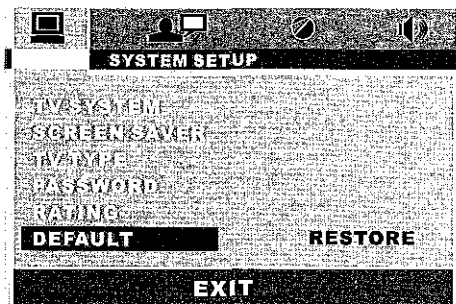

DEFAULTS

Selecting the DEFAULT item and confirming RESTORE will return ALL personal settings you have made, including radio and TV presets, to the factory default settings.

AUDIO LANGUAGE SETUP

Select the preferred AUDIO soundtrack language by touching directly the desired language .

LANGUAGE SETUP

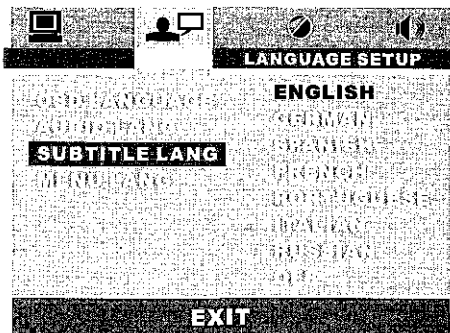
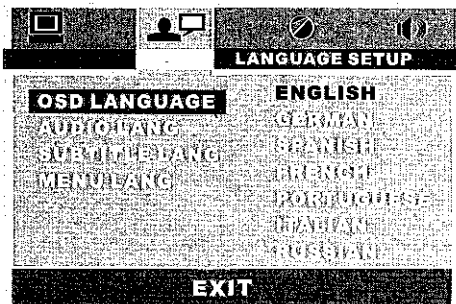

OSD LANGUAGE SETUP

Select the preferred OSD language by touching directly the desired language .

SUBTITLE LANGUAGE SETUP

Select the preferred Subtitle language by touching directly the desired language .

Touch Screen Operation

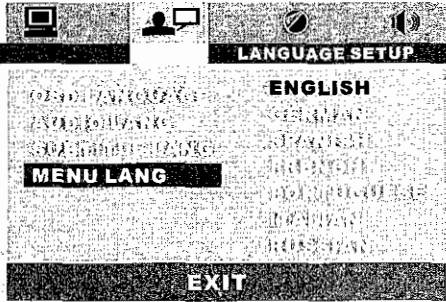

DISC MENU LANGUAGE SETUP

Select the preferred DISC MENU language by touching directly the desired language .

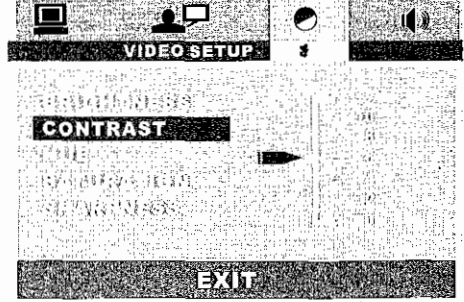

CONTRAST- the contrast of the video signal (the dark portions of pictures).

VIDEO SETUP

these settings allow you to set the video signal brightness, contrast, hue, and saturation .

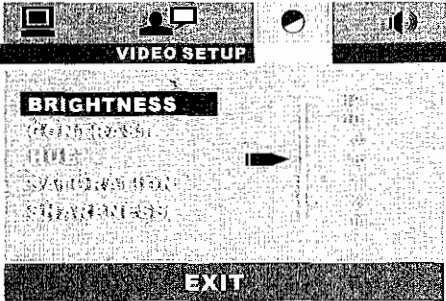

BRIGHTNESS- the brightness of the video signal (how light the picture is) .

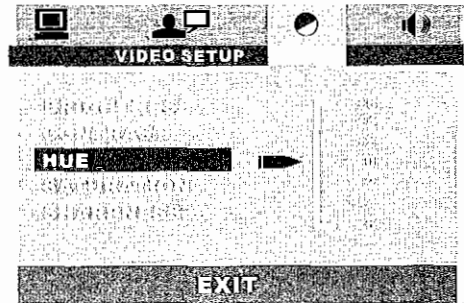

HUE- the hue of the video signal (the color of the pictures) .

Touch Screen Operation

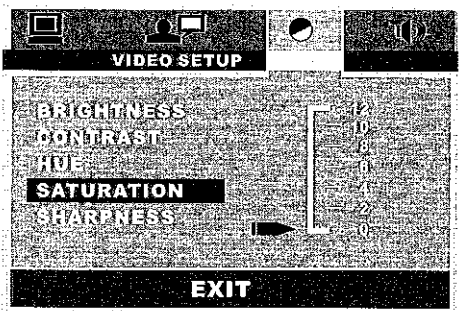

SATURATION- the saturation of the video signal (the vividness of the color) all above can be adjusted to your tasters .

DIGITAL SETUP

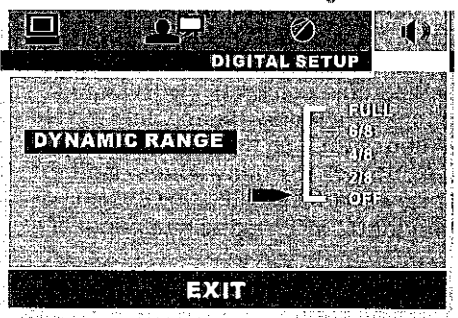

DYNAMIC RANGE CONTROL
Select DRC and adjust the dynamic range of a Dolby Digital encoded program. There are 8 steps between full compression and off compression.

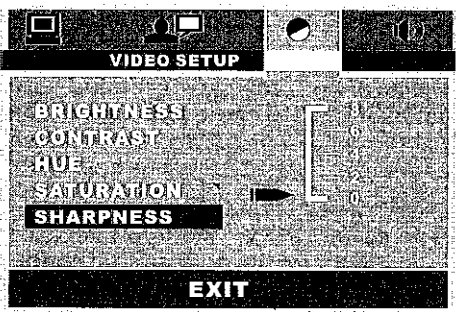

SHARPNESS- the sharpness of the video signal (the image setting acumination) .

Touch Screen Operation

AUX Operation

On the front panel of this unit, there is an AUX IN jack, follow the diagram below to connect analogue replay devices(only for the Audio connect, if you want to connect the Video, please plug the RCA <Video input > on the back of the unit .) . Use this jack to replay sound of other replay equipment such as DVD players, computers, etc. Via the loudspeakers.

1). Please connect the external device with stereo jack (3.5mm)plug the Aux in socket .

AUX IN JACK FRONT PANEL

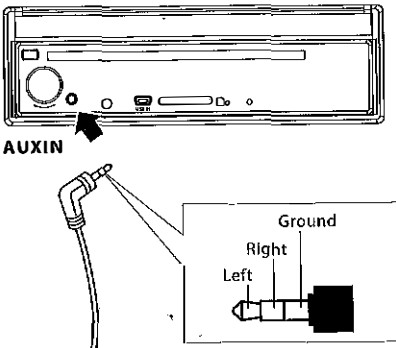

2). In main menu, touch the "AUX " ICON or press the "MOD" button on the front panel to enter theAUX IN mode .

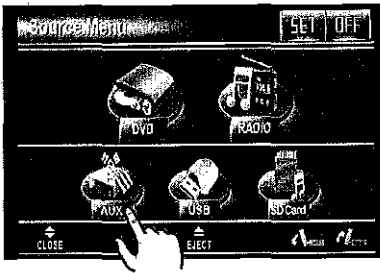

To return to the main menu

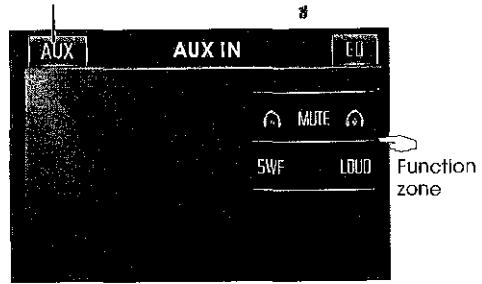

3). You now hear the sound from the external device played back through the loudspeakers .

4). Touch the volume+/- sections on touch screen or use the VOL+/- on the panel to adjust the volume level.

Touch Screen Operation

USB OPERATION

Following the diagram below, connect your USB device to the front panel USB port . If it is properly connected, the device will be mounted and start playing automatically.

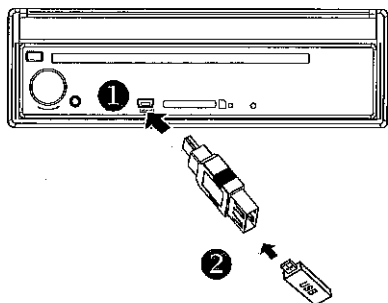

Changing From DISC to USB Playback Mode

If the disc present in the player is an DVD or VCD or MP3/WMA or MP4 disc, touch the screen of the "  " range to enter the home menu, then touch the "USB" ICON to enter the USB mode .





IMPORTANT NOTE:

To prevent damage to the USB device, do not remove or disconnect it during playback. it is also a good practice to remove the USB drive during disc playback.

IN USB PLAYBACK MODE

User can use your finger directly to touch the desired track to start play .

You can use the UP, DOWN, RIGHT or LEFT buttons to navigate and to select files to play, and press ENTER to begin playback (or viewing, in the case of JPEG files).

To skip to the next or last track, touch or press the  or  . Press the  or  buttons for Fast Forward or Fast Reverse playback.

REPEAT play modes are also available by repeatedly pushing **REPEAT** until the desired mode is found.

Changing From USB to DISC Playback modes

If you are in USB Playback mode and wish to begin playback of a disc already in the player, touch the screen of the  " range to enter home menu, then touch the "DVD" ICON to enter the DISC mode .

Touch Screen Operation

SD/MMC card OPERATION

The unit can support playback MP3/WMA/JPEG/MP4 and Divx format which are stored into SD and MMC memory card .

Please read below before you start the operation of memory card .

INSERTING THE SD OR MMC CARD .

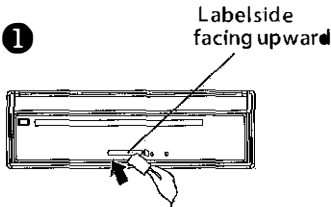

Insert the memory card into slot with label side facing upward .

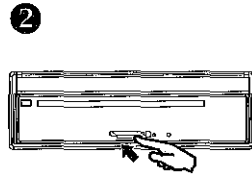

Press in till heard a "CLICK"

REMOVING THE SD OR MMC CARD .



Press in till heard a "CLICK"

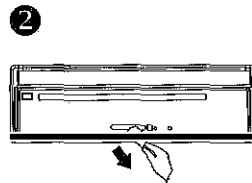

Remove the memory card

Mode change to SD/MMC card

After a SD or MMC card was inserted into the main unit card slot . the unit will starts playing the files contained on the memory card . Once the unit read the memory card successfully, the first file on the memory card will automatically start playback. Press the MODE button repeatedly is allowing changing to other modes .

Change DISC to SD/MMC card

The operations are same as USB mode, refer to see USB operation .

Change SD/MMC card to DISC

The operations are same as USB mode, refer to see USB operation .

File Playback Operation

All the SD or MMC memory car playback operation function is same as the operation on **CD/MP3/WMA** .

Please to **MP3/WMA**" operation for more details .

Touch Screen Operation

MP3/WMA/JPEG/MPEG4 DISC PLAY

The unit is support MP3/WMA/JPEG/MPEG4 . When a disc is inserted into player, the following picture will appear on the monitor . The unit will play the first track automatically . You can touch to directly others mode (MP3/JPEG /MPEG4) to play . EX. : when the MP3 mode is selected .

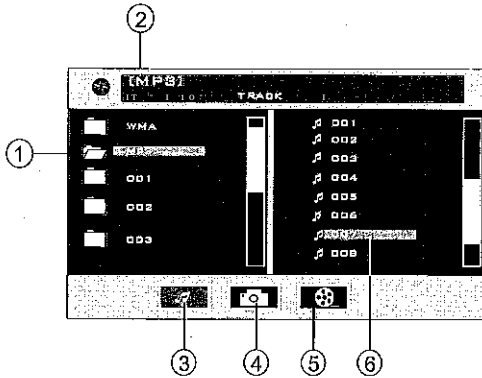

- 1 Current type (highlighted bar) .
- 2 Current track (ID3 TAG display) .
- 3 The current play mode(MP3).
- 4 Select the play mode(JPEG).
- 5 Select the play mode(MPEG4).
- 6 Current song in MP3 folder .

Touch directly to select the play mode and then touch the desired track to play . Or Use ▲ / ▼ / ► / ◀ on the remote control to select the play mode or item, then press **ENTER** button on the remote control to confirm.

MOVING TO ANOTHER TRACK :

1. Touch directly the desired song to start play .
2. Touch the ►► or ◀◀ range on the touch screen to skip a track ahead or back.
3. Press the ►► or ◀◀ button on the remote control to skip a track ahead or back.

FAST FORWARD/FAST BACKWARD

1. Touch briefly the " ►► / ◀◀ " range on touch screen for fast forward / fast backward.
2. Press shortly the ►► or ◀◀ button on the remote control for forward or backward .

REPEAT FUNCTION

Touch the screen of "REPEAT " range or press longer "REPEAT" on the remote control repeatedly can select two kinds of repeat play mode.

REP-ONE:

Play the same song over and over again.

REP ALL:

Play all songs on the disc, then repeats the entire disc over and over again .

NOTE:

in JPEG/MPEG4 mode, the details operations as same as MP3/WMA operation .

Specification

GENERAL :

Supply Voltage:	12V DC (11V-15V)	§
Current Consumption:	Less than 10A	
Signal System:	Compositive video 1.0Vp-p 75Ω	
Discs Played:	(1)DVD-VIDEO Disc 5"(12 cm) single-sided, single-layer 5"(12 cm) single-sided, double-layer (2)Compact Disc (CD-DA, VIDEO CD) 5"(12cm) disc	
Audio Signal Output:	2ch&4ch line out	
Characteristics:	(1)Frequency Response	20 Hz - 20 KHz
	(2)S/N Ratio	90 dB (JIS)
	(3)Wow and Flutter	Below measurable limits

RADIO SECTION:

	For 3 Bands (Europe)	For 2 Bands (Europe)	For 2 Bands (U.S.A.)
Frequency Coverage:	FM 87.5 to108 MHz	FM 87.5 to108 MHz	FM 87.5 to107.9 MHz
IF:	10.7 MHz	10.7 MHz	10.7 MHz
Sensitivity (S/N = 30 dB):	15 dBu MW	15 dBu MW	15dBu AM
Frequency Coverage:	522 to1620 KHz	522 to1620 KHz	530 to1710 KHz
IF:	450 KHz	450 KHz	450 KHz
Sensitivity (S/N = 20 dB):	40 dBu	40 dBu	40 dBu

TFT MONITOR:

Monitor Screen Size:	7 Inch Wide
Resolution:	1440 X 234 dots
Color System:	NTSC/PAL

NOTE:

Specifications and design are subject to modification, without notice, due to improvements in technology.

Trouble Shooting

Before going through the check list, check wiring connection. If any of the problems persist after check list has been made, consult your nearest service dealer.

SYMPTOM	CAUSE	SOLUTION
No power	The car ignition switch is not on	If the power supply is properly connected to the car accessory terminal, switch the ignition key to "ACC"
	The fuse is blown	Replace the fuse
Disc can not be loaded or ejected	Presence of disc inside the player.	Remove the disc in the player, then put a new one
	Inserting the disc in reverse direction	Insert the compact disc with the label facing upward
	The disc is extremely dirty or defective	Clean the disc or try to play a new one
	Temperature inside the car is too high	Cool off or until the ambient temperature return to normal
Television/video image appears black-white	The color system is set incorrectly	Please switch to correct color system from menu
No television/video image appears	The unit is not connected to the parking brake detection switch	Make proper connection according to "wire connection"
	The parking brake is not engaged	For safety reasons no television /video images are displayed while the vehicle is moving. Engaging the parking brake will cause images to be displayed.
No color in picture	The disc format is not according to the TV-set used (PAL/NTSC)	Please the television mode of the choice accommodation
JPEG disc can not be played back	No JPEG files are recorded on the disc.	Change the disc
	JPEG files are not recorded in a compliant format	Change the disc Record JPEG files using a compliant application
The operation keys do not work	The built-in microcomputer is not operating properly due to noise	Press the RESET button. Front panel is not properly fixed into its place
The radio does not work	The antenna cable is not connected	Insert the antenna cable firmly
	The signals are too weak	Select a station manually

88-J8201-02

www.pyleaudio.com