

BenQ



XL MONITOR FOR e-SPORTS

XL Series
Quick Start Guide

DN: Z-XL40-Q-V1

© 2017 BenQ Corporation. All rights reserved. Rights of modification reserved.

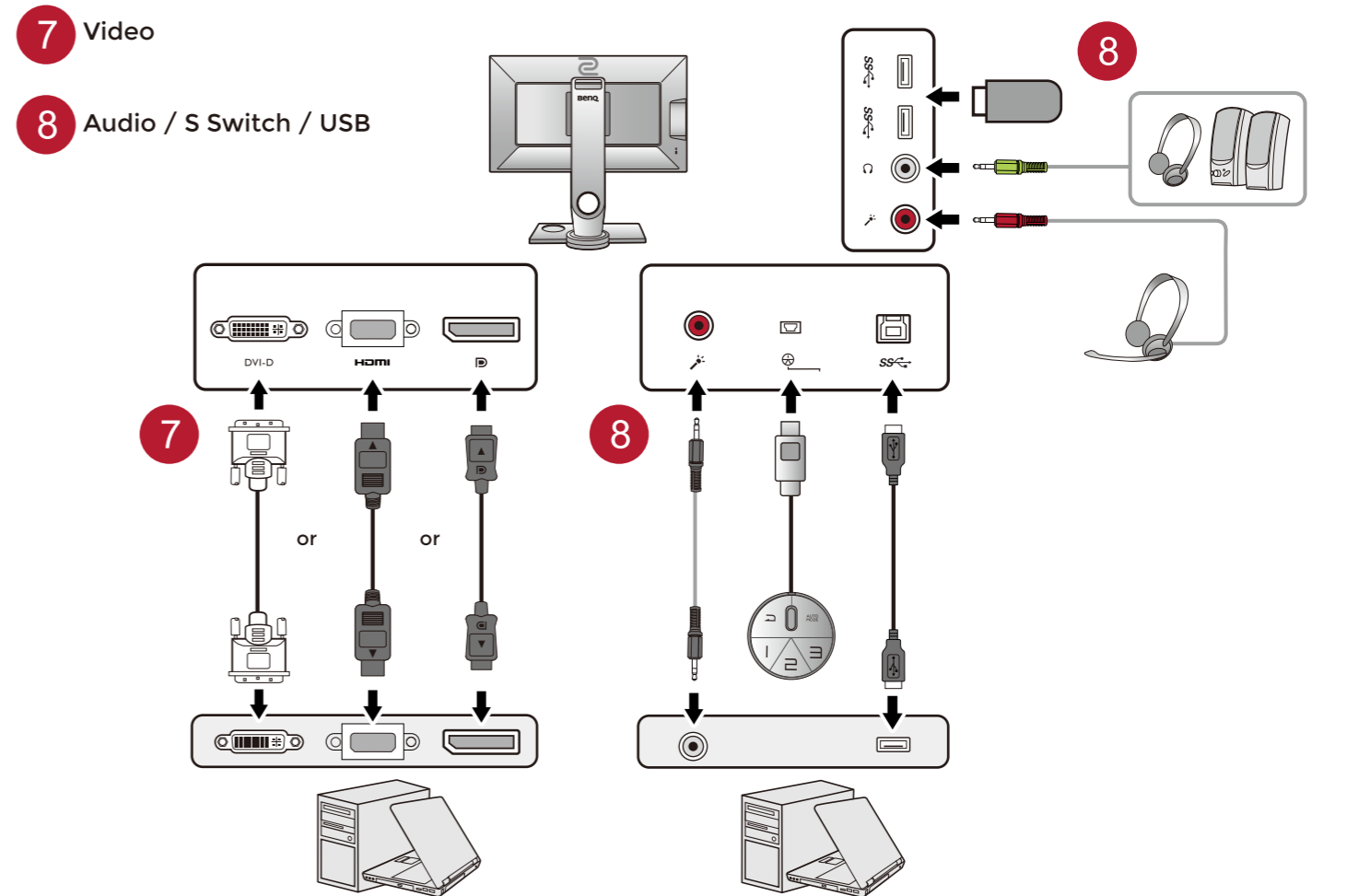
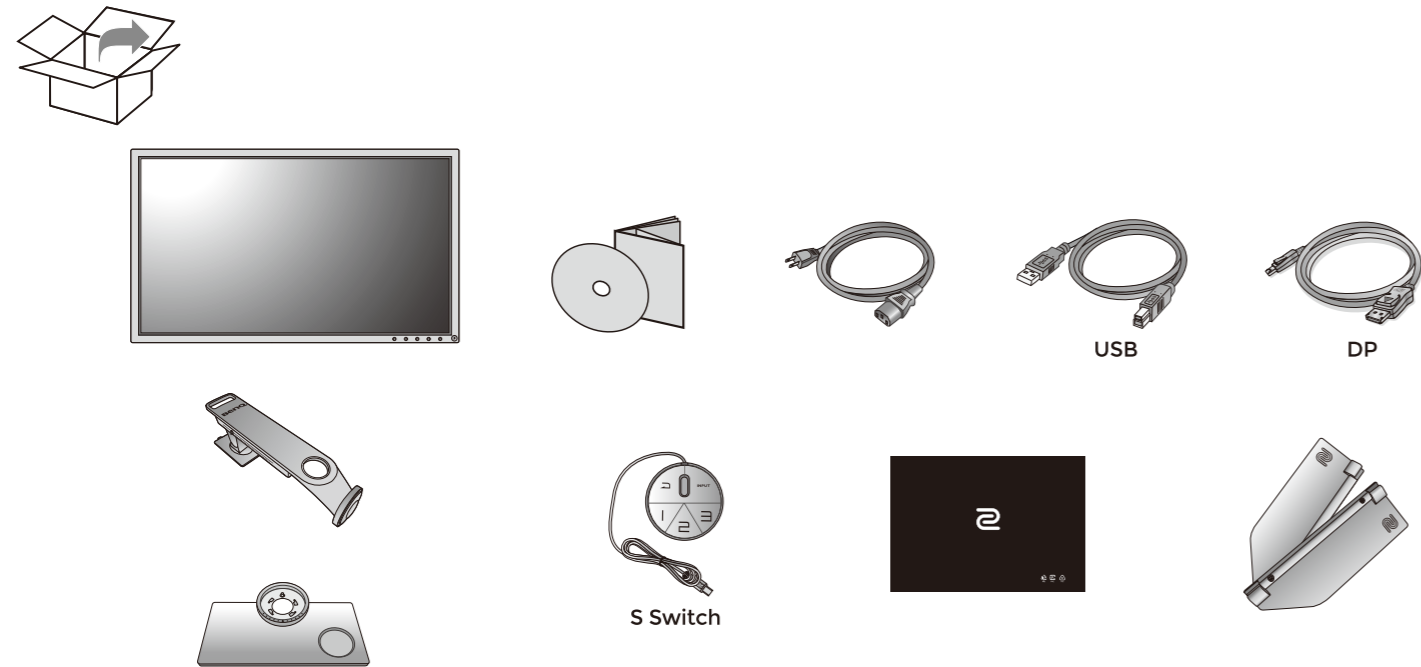
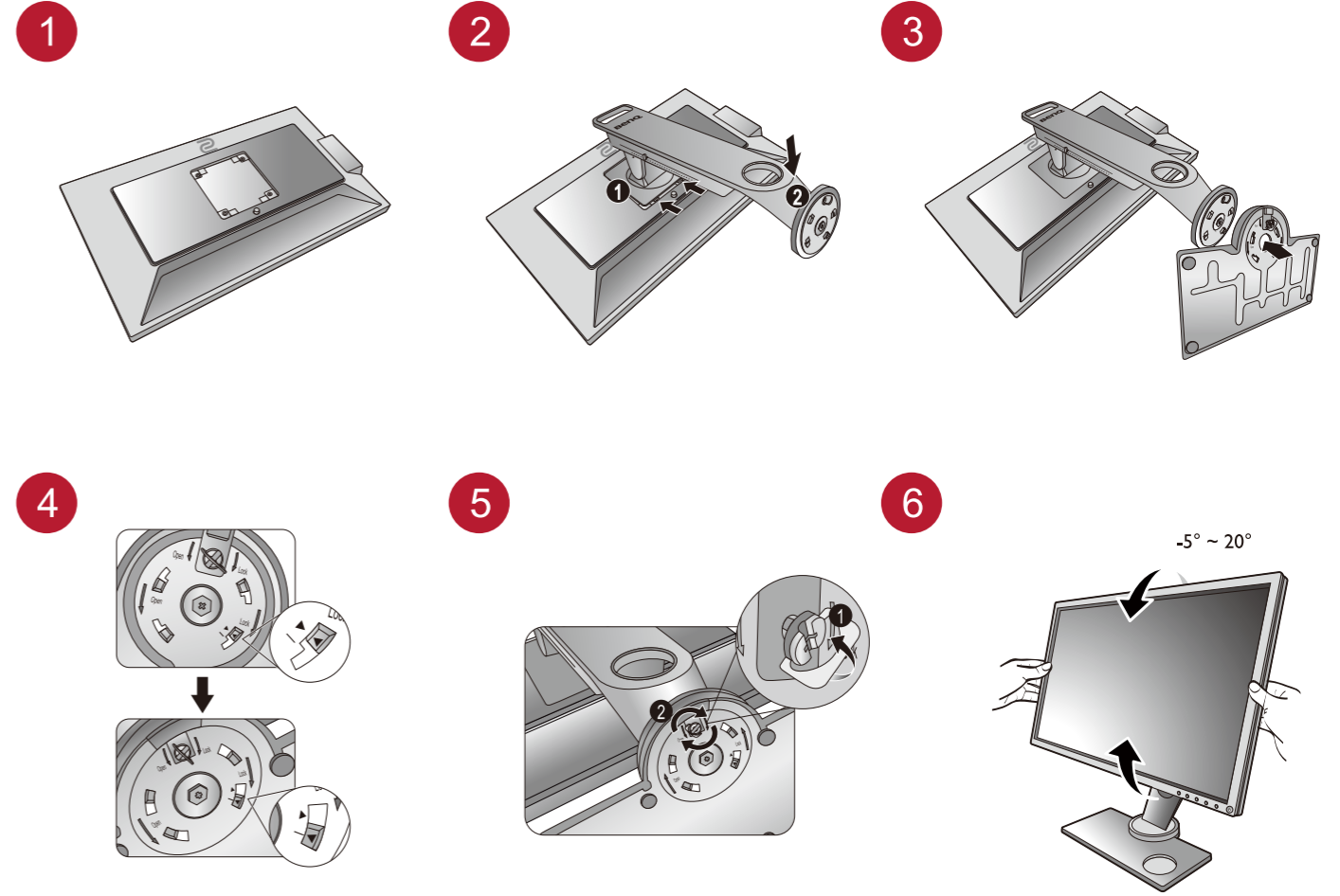

9

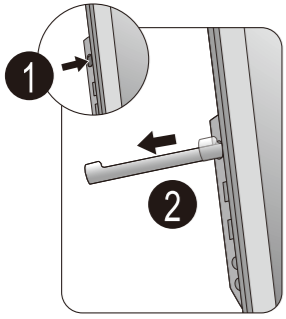

10

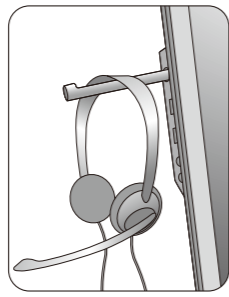

10

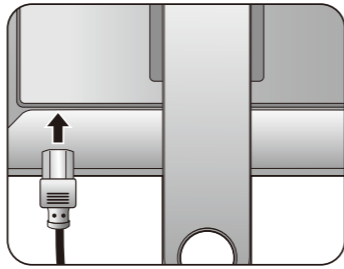

11

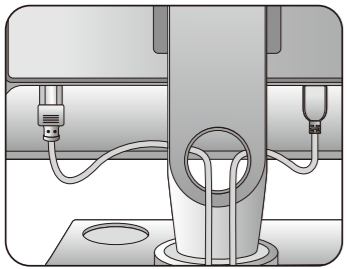

12

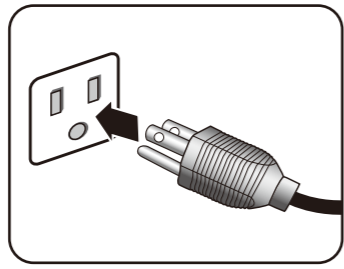

13

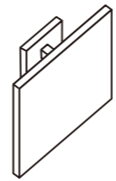
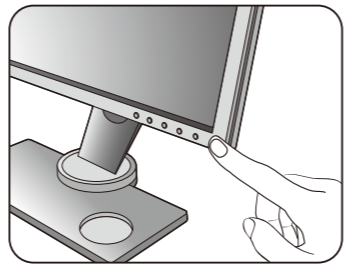

1

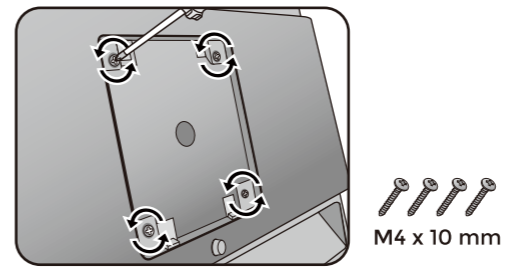

2

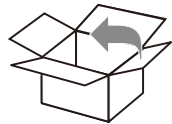
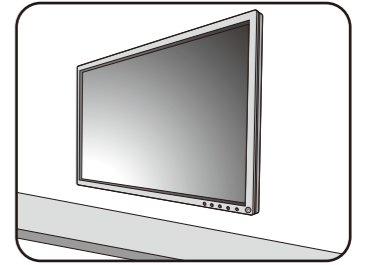

1

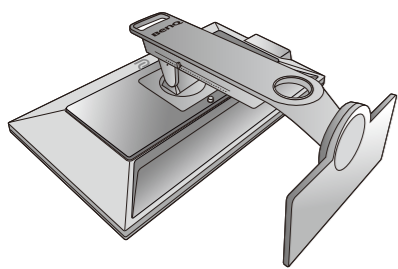

2

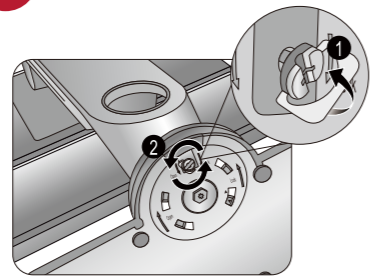

3

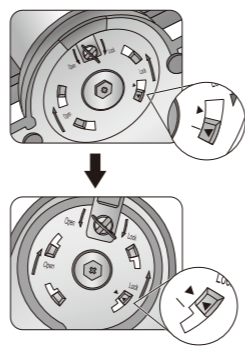

4

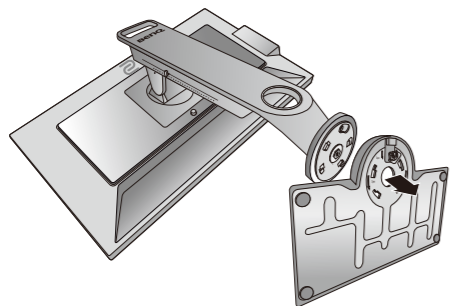

5

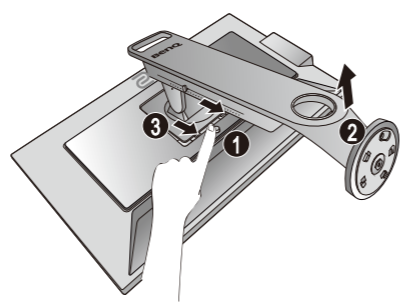

Installing the Shield (shading hood)

1

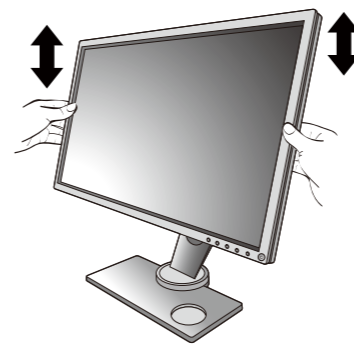

2

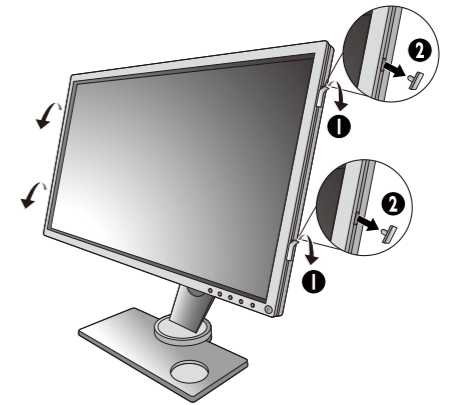

3

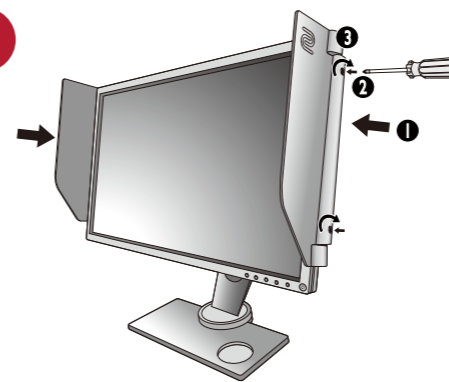

4

