

Installation Instructions

V1.0

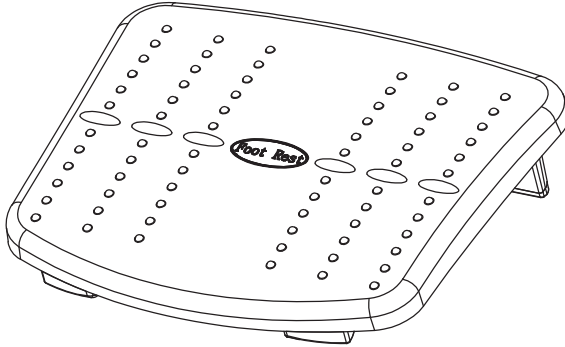

HNF5



Thank you for choosing our product! We strive to provide the best quality and services for our customers. Would you kindly share your experience on Amazon if you are satisfied? Should you have any issues, please don't hesitate to contact us.

Telephone: 800-556-0533 Mon-Fri 10am - 6pm (PST) (USA) (CAN)

Email: support@huanuoav.com (US/CA/DE/UK/FR/IT/ES/JP/AU)

1

Parts List

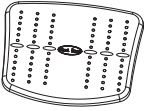
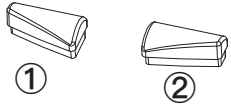
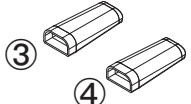
Image	Quantity
	x1
	x1
	x1

2

Assembly Steps

Option 1

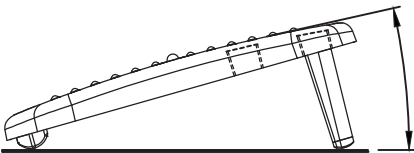
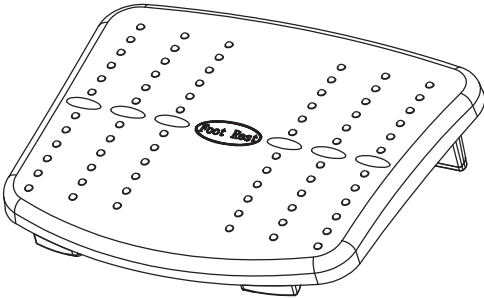
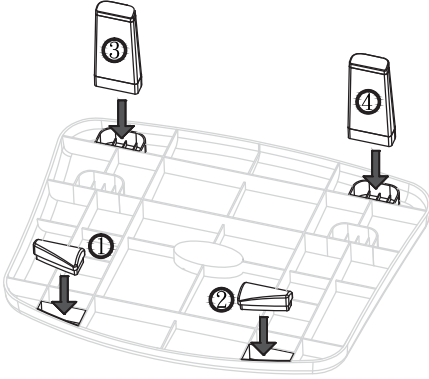

Option 2

