

THIS INSTRUCTION BOOKLET CONTAINS
IMPORTANT SAFETY INFORMATION, PLEASE
READ AND KEEP FOR FUTURE REFERENCE.

Lot Number : _____

Date: _____

ATLANTIC®

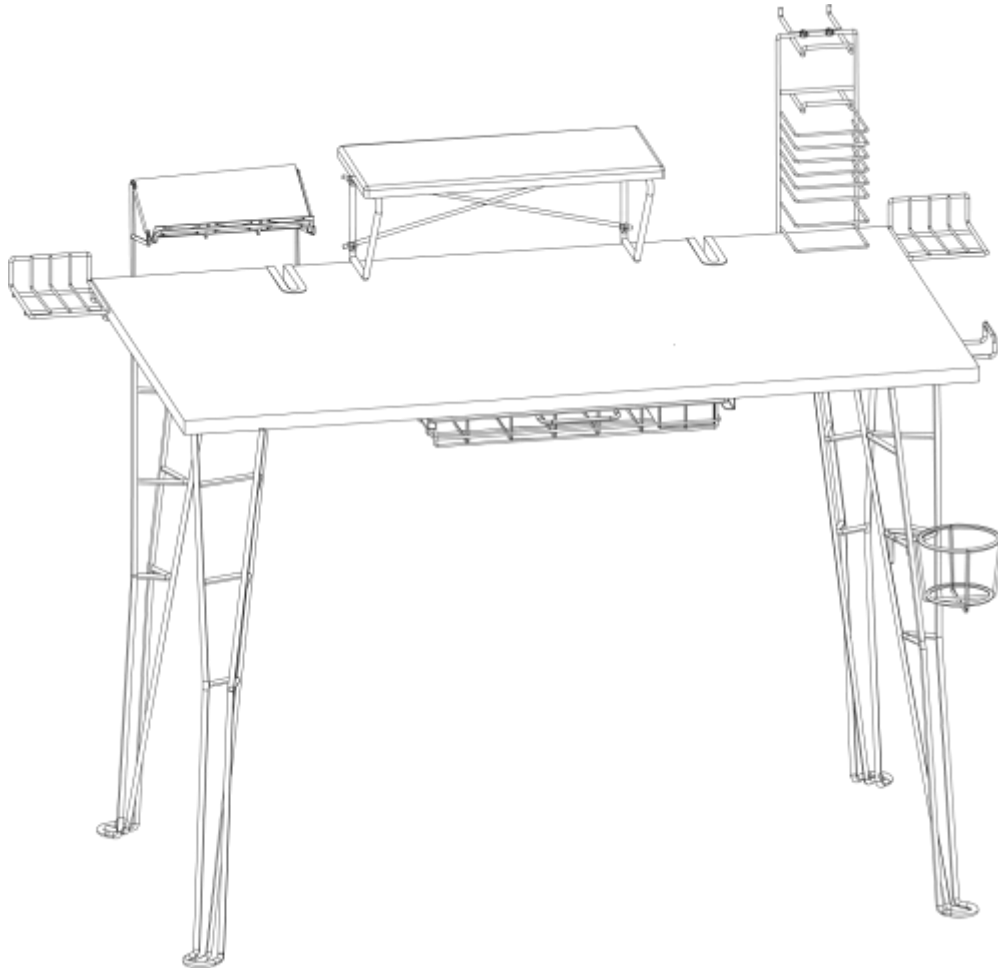

Item #:33950212

Gaming Desk Pro

Congratulations on your latest Atlantic purchase. Follow these instructions and you'll have this new product assembled in no time. If you need any help, or to order missing/replacement parts, please call 1-800-747-2660 or email customer_relations@atlantic-inc.com.

Assembly Tips:

Become familiar with the instructions and all parts.

Make sure that all parts are in the box and in good condition.

Assemble the product on the open flat carton or a rug to protect the product and your floor.

Some heavy products need a second person to assist in the assembly.

Use of power tools is not recommended.

It is strongly recommended that at least two people carry out the assembly.

Assemble the product close to a wall.

With each step, first insert and hand-tighten all bolts and screws by hand. After **ALL BOLTS** are slightly screwed in, fully tighten bolts with Phillips screwdriver in sequential pattern (clockwise or counter clockwise).



Caution:

Never let children climb on furniture or play with furniture.

Do not sit or stand on furniture.

Do not place aweight that is heavier than the recommended load rating on the furniture surface.

Do not overload shelves.

Use care when moving furniture. Furniture can tip over if moved improperly.

Improper handling can result in cuts and lacerations.

Do not install on sloping surface.

Care Instructions:

Use electrostatic dust cloths to clean furniture.

Do not set hot or cold containers directly on the furniture surface.





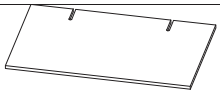















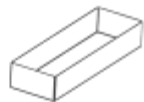

Part List

Item	Components Parts List	Q'ty
------	--------------------------	------

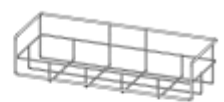

A

1

						
						
						
						
						
B						
						
						
						
						

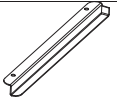





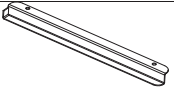















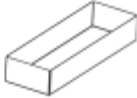

C1

1



C2

1





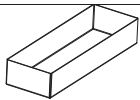

















						
						
						
						
						
						
						
						
						
						

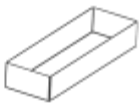





















D

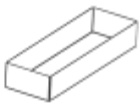























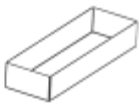





















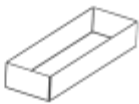

E

1

						
						
						
						
						
F						
						
						
						
						

						
						
						
						
						
G						
						
						
						
						

								
								
								
								
								
H1								
								
								
								
								

						
						
						
						
						
H2						
						
						
						
						

Tool needed(not in

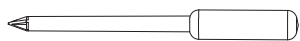

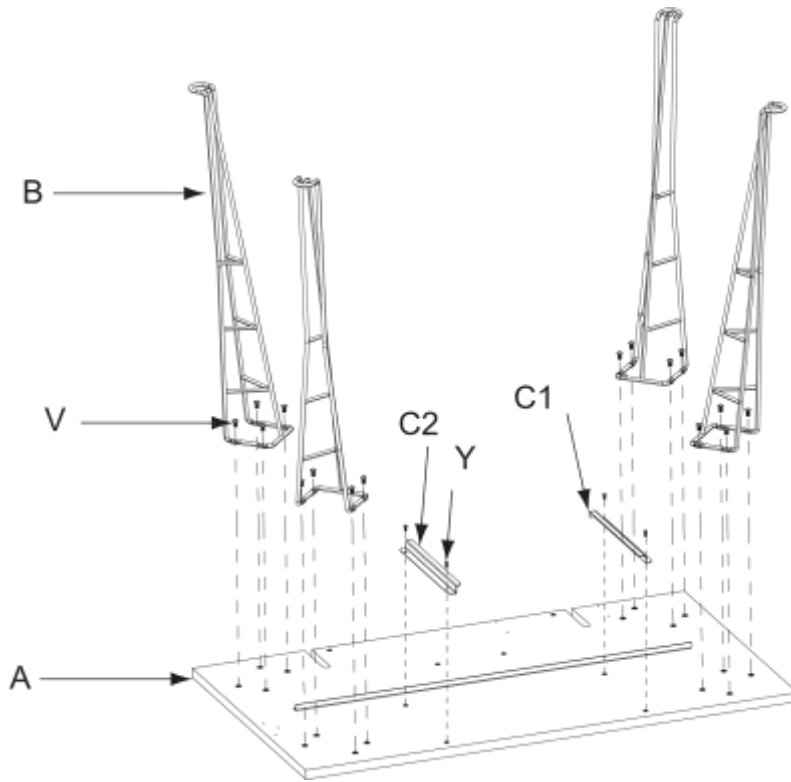

1. Fix the legs (B) to top panel (A) with screws (V), fix the drawer rail (C1 & C2) of drawer to top panel with screws (Y).

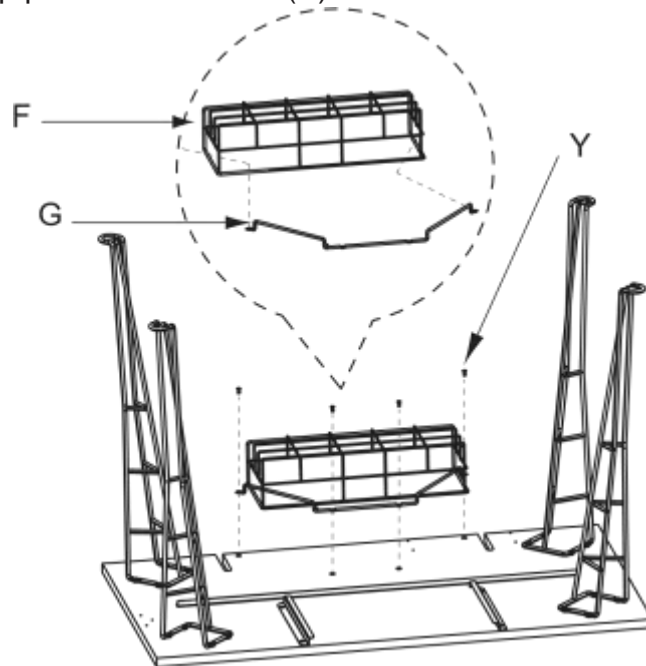

2. Insert the holding wire (G) into surge protector (F), then fix it with screws (Y).

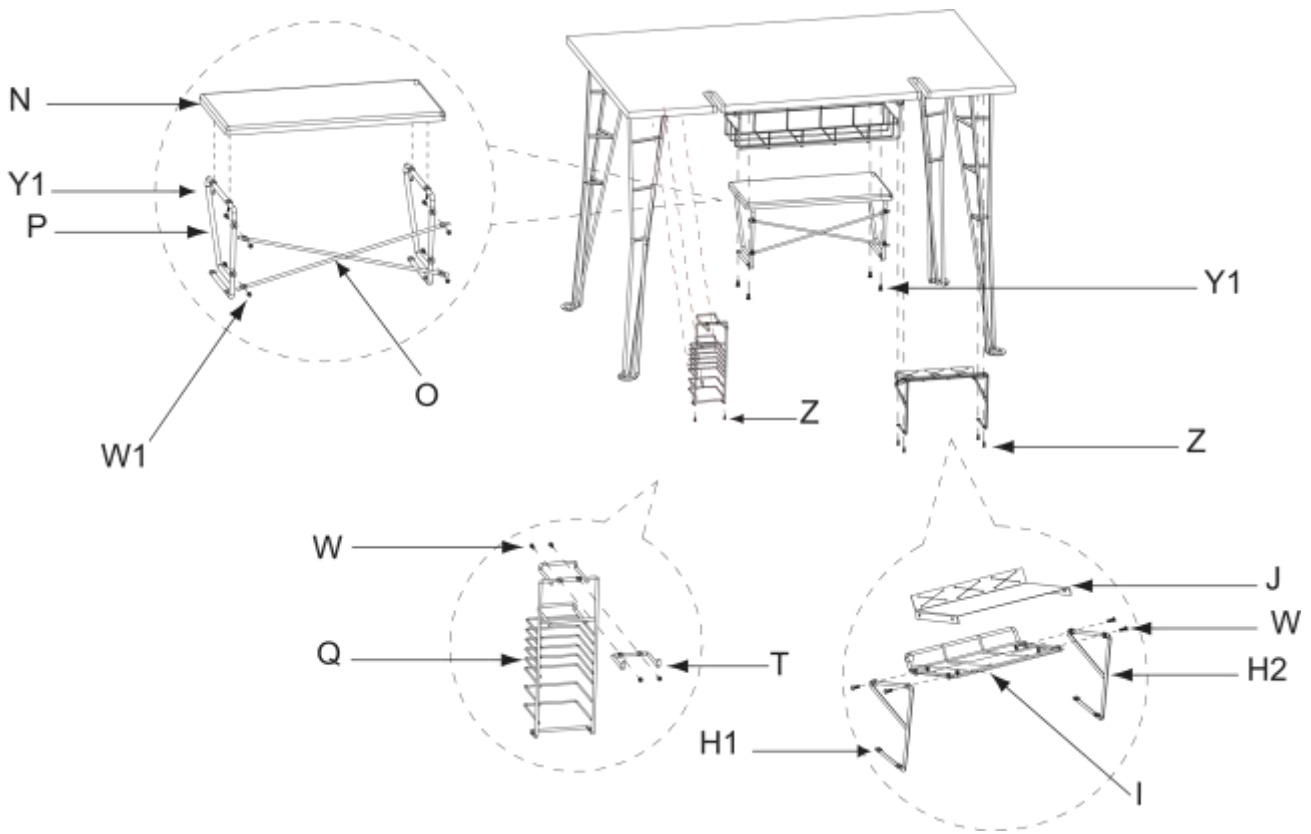

3. Turn the unit upright, then

- a- Attach monitor panel (N) to the wire support (P) with screws (Y1), fix the X bar (O) with screws and nuts (W1), then fix the monitor shelf to the top panel with screws (Y1).
- b- Attach the media holder hook (T) to the media holder (Q) with screws and nuts (W), then fix the media holder to the top panel with screws (Z).
- c- Attach the charging station shelf (I) and plastic sheet (J) to the wire support (H1 & H2) with screws and nuts (W), then fix the charging station to the top panel with screws (Z).

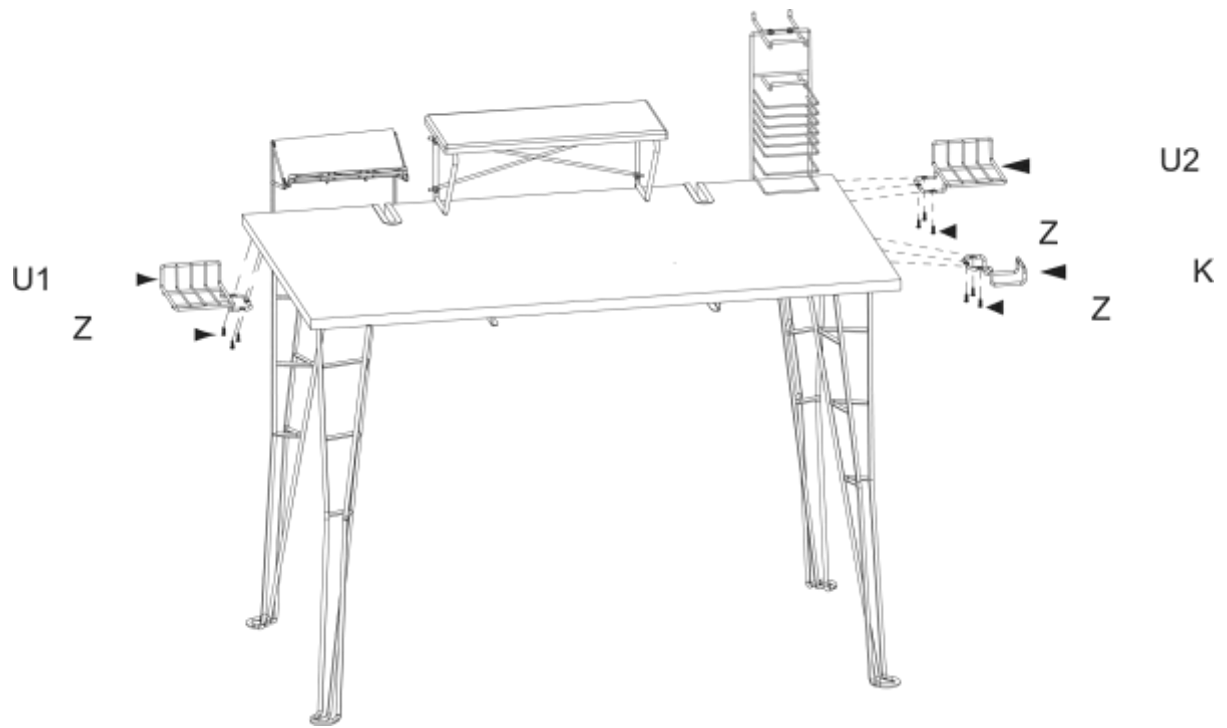

4. Fix the speaker tray (U1 & U2) to the top panel with screws (Z), fix the headphone holder (K) with screws (Z).

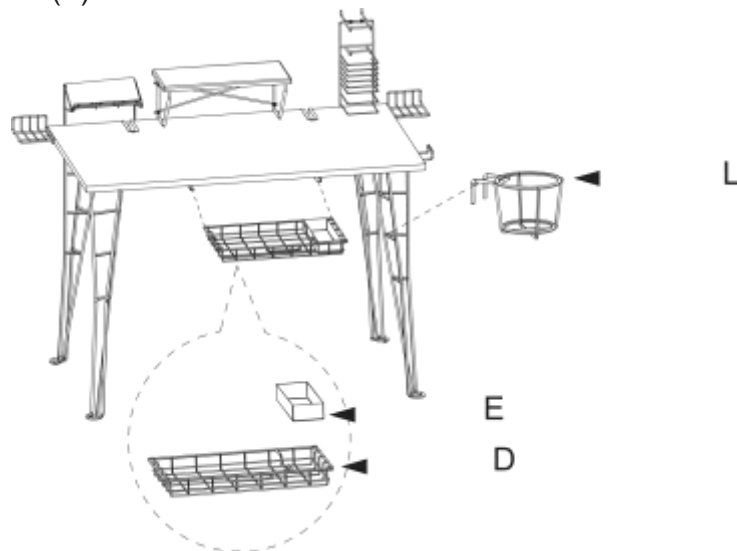

5. Fold the plastic sheet (E) to rectangular shape, then put it into drawer (D), insert the drawer into the rail, hang the cup hold (L) to the leg.

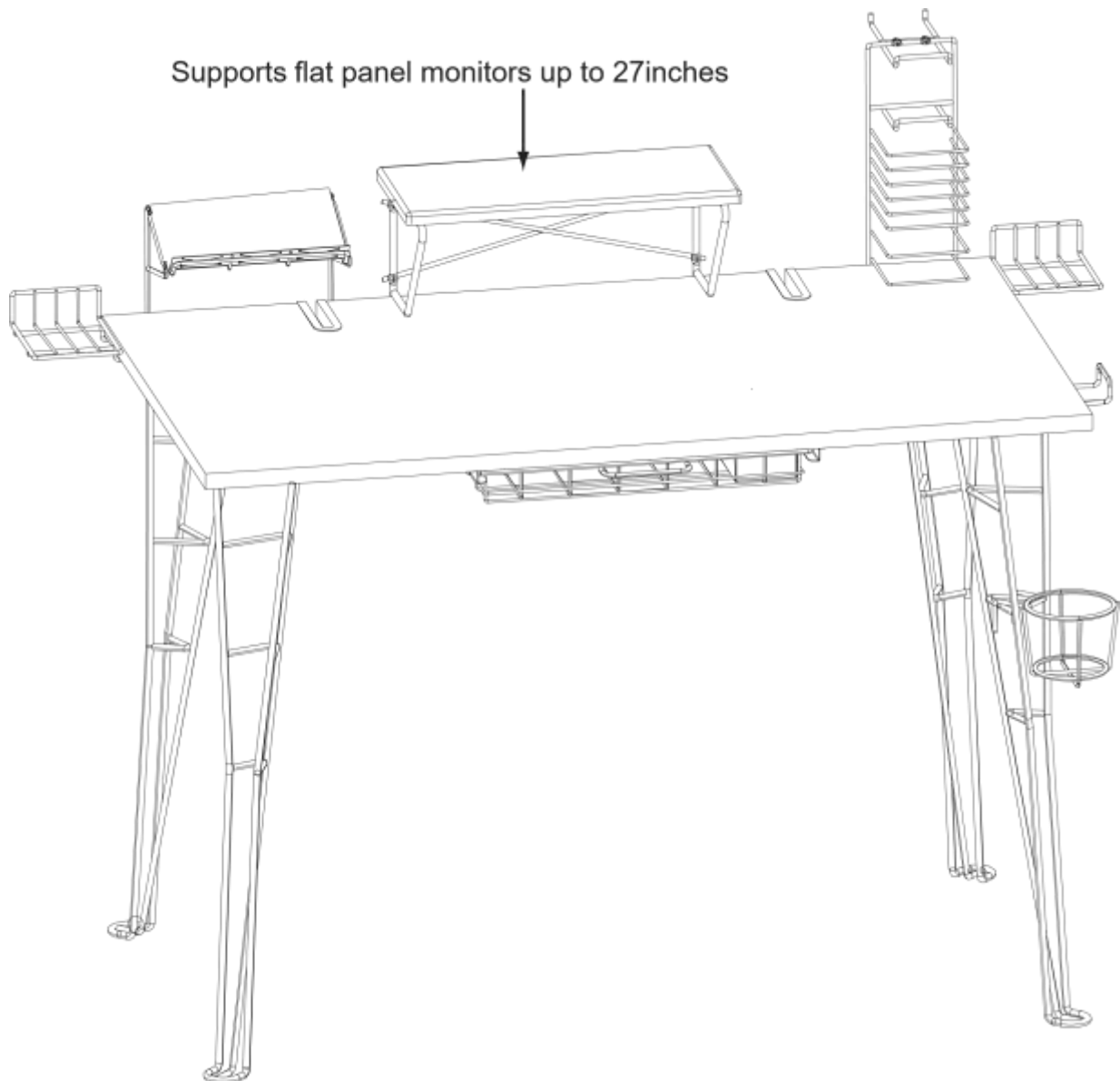

Product Warranty: Atlantic Inc. warrants to the original purchaser that its products are free from defect in materials or workmanship. If after inspection, we find that the product was defective in materials or workmanship, we shall repair or replace the product at our discretion. This warranty does not cover accidental damage, misuse, improper care or alteration and excludes claims for incidental or consequential loss. This limited warranty applies to product purchased in the U.S. and Canada.

Keep this Instruction Manual for future reference.
Keep your original proof of purchase (store receipt).

If parts are missing, DO NOT return to the store. To order missing / replacement parts or for assembly assistance please contact customer_relations@atlantic-inc.com. Or call 1-800- 747-2660 M-F, 8am- 5pm, P.S.T.

ATLANTIC⁶

©2011 Atlantic Inc. Santa Fe Springs, CA. U.S.A.
U.S. and other foreign patents pending /
Patentes de los EUA y países extranjeros en
trámite /
Brevets en cours pour les États-Unis et autres pays
/
U.S. und andere ausländische Patente sind hängig

All rights reserved / Derechos Reservados /
Tous droits réservés

Made in China / Hecho en China /
Fabriqué en Chine www.atlantic-inc.com

R1.0 110712# 33935701