

COASTER[®]
FINE FURNITURE

100951

GAME TABLE

**ASSEMBLY INSTRUCTION
COASTER FINE FURNITURE**



www.coastercompany.com

Assembly Instruction

ASSEMBLY TIPS:











1. Remove hardware from box and sort by size.
2. Please check to see that all hardware and parts are present prior to start of assembly.
3. Please follow attached instructions in the same sequence as numbered to assure fast & easy assembly.





Warning !



1. Don't attempt to repair or modify parts that are broken or defective .Please contact the store immediately.
2. This product is for home use only and not intended for commercial establishment.

PARTS IDENTIFICATION

	A	DINING TOP	1 PC		F	BALL SET	1 SET
	B	POOL TOP	1 PC		G	CUE STICK	2 PCS
	C	PEDESTAL	1 PC		H	CHALK	2 PCS
	D	MOUNTING BOARD	1 PC		I	BRUSH	1 PC
	E	LEG	4 PCS		J	DRAWER	2 PCS

Z	HARDWARE PACKAGE		
NO:	DESCRIPTION	FIGURE	Q'TY
1	NUT		12 PCS
2	WASHER		16 PCS
3	40mm - BOLT		4 PCS
4	TOOL		1 PC

STEP 1:

Attach the Legs (E) to the Pedestal (C) with Nut (1) and Washer (2).

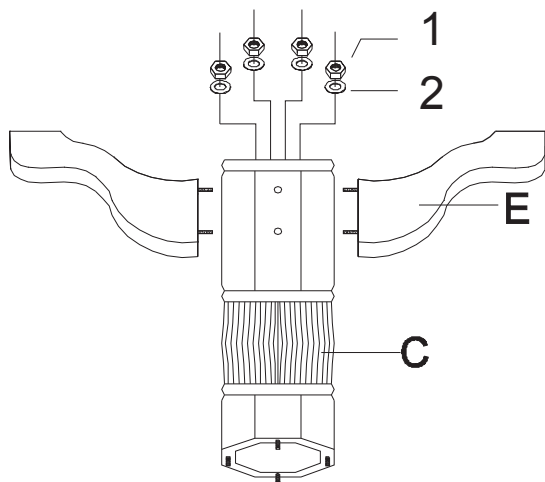

STEP 2:

Attach the Mounting Board (D) with with Nut (1) and Washer (2).

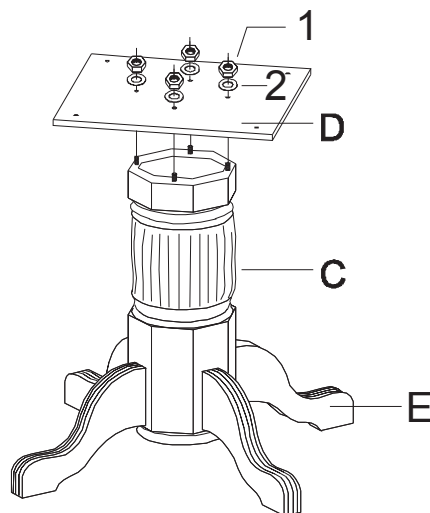

STEP 3:

Attach the Pool Top (B) to the Mounting Board (D) with Bolt (3) and Washer (2). Then attach Drawer (J) to the Pool Top (B) . Put the Dining Top (A) on Pool Top (B) .

