



User Guide

© 2015 Hewlett-Packard Development
Company, L.P.

HDMI, the HDMI Logo and High-Definition
Multimedia Interface are trademarks or
registered trademarks of HDMI Licensing LLC.
Microsoft and Windows are U.S. registered
trademarks of the Microsoft group of
companies.

The information contained herein is subject to
change without notice. The only warranties for
HP products and services are set forth in the
express warranty statements accompanying
such products and services. Nothing herein
should be construed as constituting an
additional warranty. HP shall not be liable for
technical or editorial errors or omissions
contained herein.

First Edition: February 2015

Document Part Number: 799857-001a

About This Guide

This guide provides information on monitor features, setting up the monitor, and technical specifications.

 **WARNING!** Text set off in this manner indicates that failure to follow directions could result in bodily harm or loss of life.

 **CAUTION:** Text set off in this manner indicates that failure to follow directions could result in damage to equipment or loss of information.

 **NOTE:** Text set off in this manner provides important supplemental information.

 **TIP:** Text set off in this manner provides helpful hints.



This product incorporates HDMI technology.

Table of contents

1 Product features	1
HP Z Displays	1
2 Safety and maintenance guidelines	3
Important safety information	3
Maintenance guidelines	4
Cleaning the monitor	4
Shipping the monitor	4
3 Setting up the monitor	5
Use caution when setting up the monitor	5
Installing the stand	6
Rear components	7
Connecting the cables	8
Front panel controls	12
Adjusting the monitor	13
Turning on the monitor	15
Connecting USB devices	16
Removing the monitor stand	17
Mounting the monitor	17
Mounting the monitor to a fixture	17
Locating the serial number and product number	19
Installing a cable lock	19
4 Operating the monitor	20
Software and utilities	20
The Information file	20
The Image Color Matching file	20
Installing the .INF and .ICM files	20
Installing from the disc	20
Downloading from the Web	21
Using the On-Screen Display (OSD) menu	21
Using Picture-in-Picture (PIP) and Picture-beside-Picture (PBP)	22
DisplayPort Multistreaming	22
Using Auto-Sleep Mode	24

Appendix A Technical specifications	25
23.8-inch Full HD/QHD Models	25
24-inch Model	26
25-inch QHD Model	26
27-inch QHD Model	27
Recognizing Preset Display Resolutions	28
23.8-inch Full HD Model	28
24-inch Model	29
23.8-inch QHD/25-inch/27-inch Models	30
High Definition Video Formats	30
 Appendix B Support and troubleshooting	 31
Solving common problems	31
Button lockouts	31
Product support	32
Preparing to call technical support	32
 Appendix C LCD monitor quality and pixel policy	 33
 Appendix D Accessibility	 34
Supported assistive technologies	34
Contacting support	34

1 Product features

HP Z Displays

The monitor features include:

- 60 cm (23.8-inch Full HD) diagonal viewable area display with 1920 x 1080 resolution, plus full-screen support for lower resolutions; includes custom scaling for maximum image size while preserving original aspect ratio
- 60 cm (23.8-inch QHD) diagonal viewable area display with 2560 x 1440 resolution, plus full-screen support for lower resolutions, includes custom scaling for maximum image size while preserving original aspect ratio
- 61 cm (24-inch) diagonal viewable area display with 1920 x 1200 resolution, plus full-screen support for lower resolutions; includes custom scaling for maximum image size while preserving original aspect ratio
- 63.44 cm (25-inch) diagonal viewable area display with 2560 x 1440 resolution, plus full-screen support for lower resolutions; includes custom scaling for maximum image size while preserving original aspect ratio
- 68.47 cm (27-inch) diagonal viewable area display with 2560 x 1440 resolution, plus full-screen support for lower resolutions; includes custom scaling for maximum image size while preserving original aspect ratio
- Non-glare panel with an LED backlight
- Wide viewing angle to allow viewing from a sitting or standing position, or moving from side-to-side
- Tilt capability
- Pivot capability to rotate the display from landscape to portrait
- Swivel and height adjustment capabilities
- Removable stand for flexible monitor panel mounting solutions
- HP Quick Release 2 device to quickly install the monitor panel to the stand with a simple click, and then remove it with the convenient sliding tab release
- DVI-D, DisplayPort, and Mini-DisplayPort video inputs
- One HDMI (High-Definition Multimedia Interface) video input with MHL (Mobile High-Definition Link)
- PIP (picture-in-picture) functionality to enable the DVI, DisplayPort and HDMI inputs to be viewed in a small secondary window or side-by-side on the main window
- Audio-out (headphone) jack
- USB 3.0 hub with one upstream port (connects to the computer) and four downstream ports (connects to USB devices)
- USB cable provided to connect the monitor's USB hub to the USB connector on the computer
- Six front bezel Touch Key buttons
- Supports an optional HP speaker bar

- Plug and play capability if supported by your operating system
- Security slot provision on rear of monitor for optional cable lock
- Cable management feature for placement of cables and cords
- On-Screen Display (OSD) adjustments in several languages for easy setup and screen optimization
- HP Display Assistant for adjusting monitor settings and enabling theft deterrence features (refer to the *HP Display Assistant User Guide* included on the disc with your monitor)
- HDCP (High-Bandwidth Digital Content Protection) copy protection on all digital inputs
- Software and documentation disc that includes monitor drivers and product documentation
- Energy saver feature to meet requirements for reduced power consumption



NOTE: For safety and regulatory information, refer to the *Product Notices* provided on your media disc, if one is included, or in your documentation kit. To locate updates to the user guide for your product, go to <http://www.hp.com/support>, and select your country. Select **Drivers & Downloads**, and then follow the on-screen instructions.

2 Safety and maintenance guidelines

Important safety information

A power cord is included with the monitor. If another cord is used, use only a power source and connection appropriate for this monitor. For information on the correct power cord set to use with the monitor, refer to the *Product Notices* provided on your media disc, if one is included, or in your documentation kit.

 **WARNING!** To reduce the risk of electric shock or damage to the equipment:

- Plug the power cord into an AC outlet that is easily accessible at all times.
- Disconnect power from the computer by unplugging the power cord from the AC outlet.
- If provided with a 3-pin attachment plug on the power cord, plug the cord into a grounded (earthed) 3-pin outlet. Do not disable the power cord grounding pin, for example, by attaching a 2-pin adapter. The grounding pin is an important safety feature.

For your safety, do not place anything on power cords or cables. Arrange them so that no one may accidentally step on or trip over them. Do not pull on a cord or cable. When unplugging from the electrical outlet, grasp the cord by the plug.

To reduce the risk of serious injury, read the *Safety and Comfort Guide*. It describes proper workstation, setup, posture, and health and work habits for computer users, and provides important electrical and mechanical safety information. This guide is located on the Web at <http://www.hp.com/ergo>.

 **CAUTION:** For the protection of the monitor, as well as the computer, connect all power cords for the computer and its peripheral devices (such as a monitor, printer, scanner) to some form of surge protection device such as a power strip or Uninterruptible Power Supply (UPS). Not all power strips provide surge protection; the power strips must be specifically labeled as having this ability. Use a power strip whose manufacturer offers a Damage Replacement Policy so you can replace the equipment, if surge protection fails.

Use the appropriate and correctly sized furniture designed to properly support your HP LCD monitor.

 **WARNING!** LCD monitors that are inappropriately situated on dressers, bookcases, shelves, desks, speakers, chests, or carts may fall over and cause personal injury.

Care should be taken to route all cords and cables connected to the LCD monitor so that they cannot be pulled, grabbed, or tripped over.

 **NOTE:** This product is suitable for entertainment purposes. Consider placing the display in a controlled luminous environment to avoid interference from surrounding light and bright surfaces that may cause disturbing reflections from the screen.

Maintenance guidelines

To enhance the performance and extend the life of the monitor:

- Do not open the monitor cabinet or attempt to service this product yourself. Adjust only those controls that are covered in the operating instructions. If the monitor is not operating properly or has been dropped or damaged, contact an authorized HP dealer, reseller, or service provider.
- Use only a power source and connection appropriate for this monitor, as indicated on the label/back plate of the monitor.
- Be sure the total ampere rating of the products connected to the outlet does not exceed the current rating of the electrical outlet, and the total ampere rating of the products connected to the cord does not exceed the rating of the cord. Look on the power label to determine the ampere rating (AMPS or A) for each device.
- Install the monitor near an outlet that you can easily reach. Disconnect the monitor by grasping the plug firmly and pulling it from the outlet. Never disconnect the monitor by pulling the cord.
- Turn the monitor off when not in use. You can substantially increase the life expectancy of the monitor by using a screen saver program and turning off the monitor when not in use.



NOTE: Monitors with a “burned-in image” are not covered under the HP warranty.

- Slots and openings in the cabinet are provided for ventilation. These openings must not be blocked or covered. Never push objects of any kind into cabinet slots or other openings.
- Do not drop the monitor or place it on an unstable surface.
- Do not allow anything to rest on the power cord. Do not walk on the cord.
- Keep the monitor in a well-ventilated area, away from excessive light, heat or moisture.
- When removing the monitor stand, you must lay the monitor face down on a soft area to prevent it from getting scratched, defaced, or broken.

Cleaning the monitor

1. Turn off the monitor and unplug the power cord from the back of the unit.
2. Dust the monitor by wiping the screen and the cabinet with a soft, clean antistatic cloth.
3. For more difficult cleaning situations, use a 50/50 mix of water and Isopropyl alcohol.



CAUTION: Spray the cleaner onto a cloth and use the damp cloth to gently wipe the screen surface. Never spray the cleaner directly on the screen surface. It may run behind the bezel and damage the electronics.

CAUTION: Do not use cleaners that contain any petroleum based materials such as benzene, thinner, or any volatile substance to clean the monitor screen or cabinet. These chemicals may damage the monitor.

Shipping the monitor

Keep the original packing box in a storage area. You may need it later if you move or ship the monitor.

3 Setting up the monitor

To set up the monitor, ensure that the power is turned off to the monitor, computer system, and other attached devices, then follow the instructions below.

 **NOTE:** Be sure the master power switch, located on the rear panel of the monitor, is in the off position. The master power switch turns off all power to the monitor.

Use caution when setting up the monitor

To prevent damage to the monitor, do not touch the surface of the LCD panel. Pressure on the panel may cause non-uniformity of color or disorientation of the liquid crystals. If this occurs the screen will not recover to its normal condition.

If installing a stand, lay the monitor face down on a flat surface covered with a protective sheet foam or non-abrasive cloth. This prevents the screen from getting scratched, defaced or broken as well as damage to the front panel buttons.



 **NOTE:** Your monitor may look different from the monitor in this illustration.

Installing the stand

⚠ CAUTION: Do not touch the surface of the LCD panel. Pressure on the panel may cause non-uniformity of color or disorientation of the liquid crystals. If this occurs the screen will not recover to its normal condition.

💡 TIP: Consider the placement of the display, because the bezel might cause interfering reflections from surrounding light and bright surfaces.





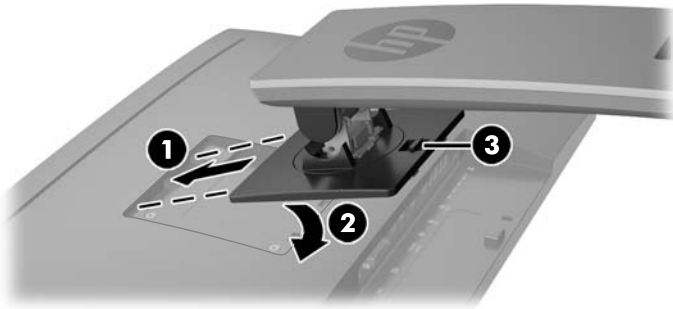

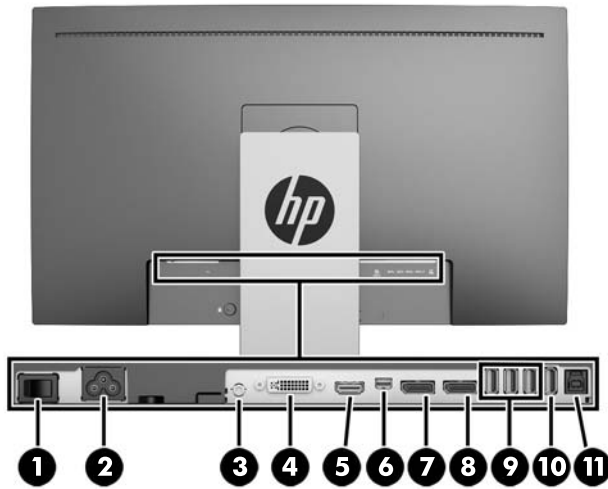

The display uses the HP Quick Release 2 for easy mounting of the monitor. To mount the panel onto the stand:

1. Lay the monitor panel face down on a flat surface covered by a clean, dry cloth.
2. Slide the top of the mounting plate (1) on the stand under the upper lip of the recess in the back of the panel.
3. Lower the bottom of the stand's mounting plate (2) into the recess until it snaps into place.
4. The HP Quick Release 2 latch (3) pops up when the stand is locked in place.



Rear components



Component	Icon	Function
1 Master Power Switch		Turns off all power to the monitor. NOTE: Putting the switch in the Off position will yield the lowest power state for the monitor when not in use.
2 Power Connector		Connects the AC power cord to the monitor.
3 Audio-out		Connects headphones or an optional HP Speaker Bar to the monitor.
4 DVI-D		Connects the DVI-D cable to the monitor.
5 HDMI (MHL)	HDMI (MHL)	Connects an HDMI or MHL cable from the source device to the monitor.
6 Mini-DisplayPort		Connects the Mini-DisplayPort cable from the source device to the monitor.
7 DisplayPort IN		Connects the DisplayPort cable from the source device to the monitor.
8 DisplayPort OUT		Connects the DisplayPort cable from the primary monitor to the secondary monitor.
9 USB 3.0 Standard Downstream (3)		Connects optional USB devices to the monitor.
10 USB 3.0 Downstream Fast Charge (1)		Connects and charges optional USB battery-powered devices.
11 USB 3.0 Upstream		Connects the USB hub cable from the source device to the monitor.

Connecting the cables

 **NOTE:** The monitor ships with select cables. Not all cables shown in this section are included with the monitor.

1. Place the monitor in a convenient, well-ventilated location near the computer.
2. Before connecting the cables, route the cables through the cable routing hole in the center of the stand.

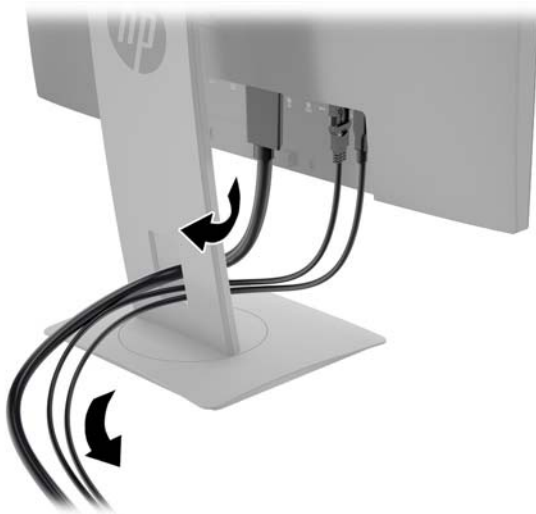

3. Connect a video cable.

 **NOTE:** The monitor will automatically determine which inputs have valid video signals. The inputs can be selected by pressing the **Next Input** button on the front panel or through the On-Screen Display (OSD) by pressing the **Menu** button and selecting **Input Control**.

- Connect a DVI-D cable to the DVI-D connector on the rear of the monitor and the other end to the DVI-D connector on the source device.

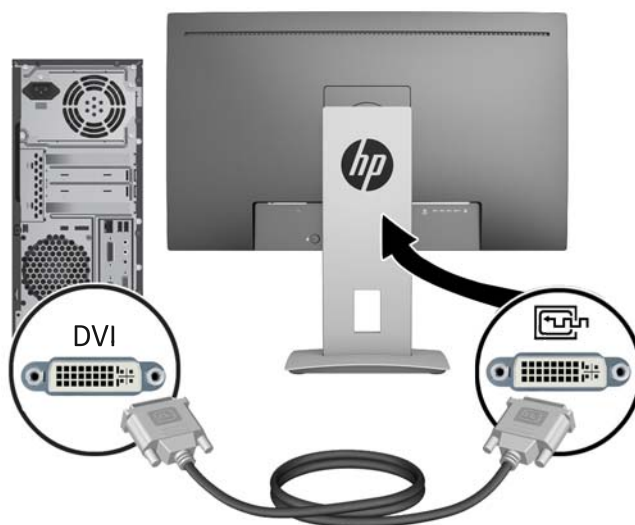

- Connect a DisplayPort cable to the DisplayPort IN connector on the rear of the monitor and the other end to the DisplayPort connector on the source device.

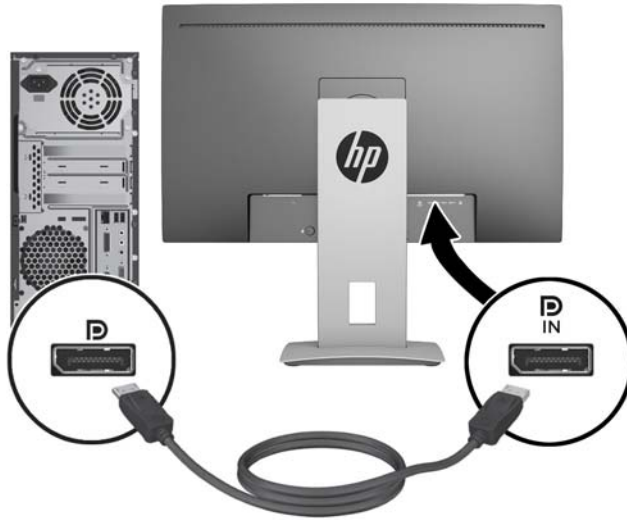

- Connect a Mini-DisplayPort cable to the Mini-DisplayPort connector on the rear of the monitor and the other end to the DisplayPort connector on the source device.

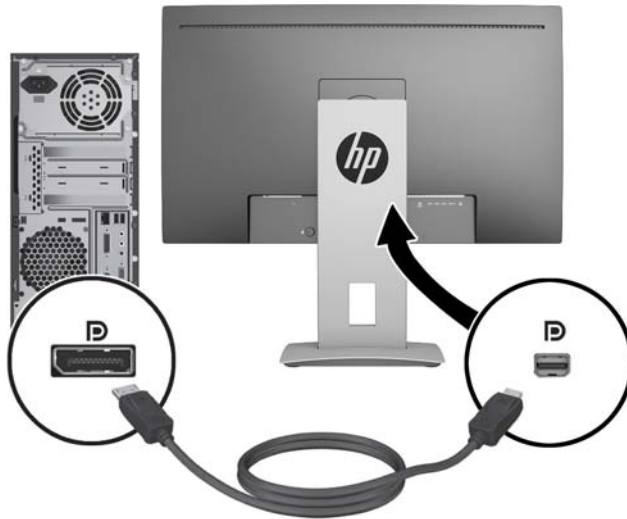

- Connect an HDMI cable to the HDMI port on the rear of the monitor and the other end to the source device.

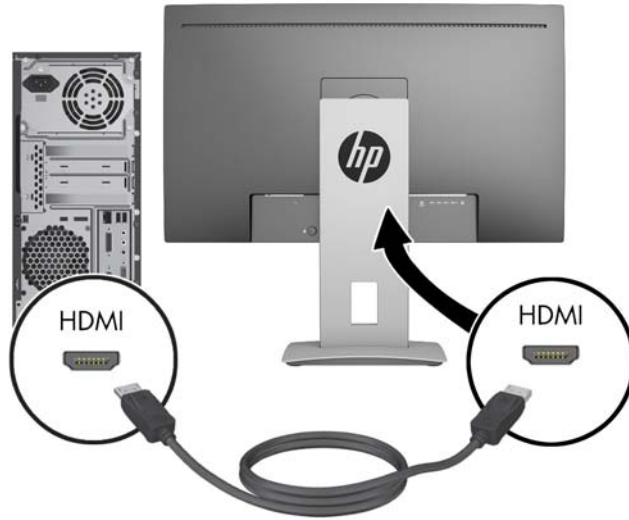

- Connect an MHL cable to the HDMI (MHL) port on the rear of the monitor and to the micro USB port on an MHL-enabled source device, such as a smart phone or tablet, to stream content from the mobile device to your monitor screen.

 **NOTE:** The MHL video is limited to the mobile device output resolution.

 **NOTE:** The MHL connector also charges your MHL mobile device while connected and streaming.

 **NOTE:** You can also connect an HDMI cable between the HDMI (MHL) port on the monitor and an HDMI source device.

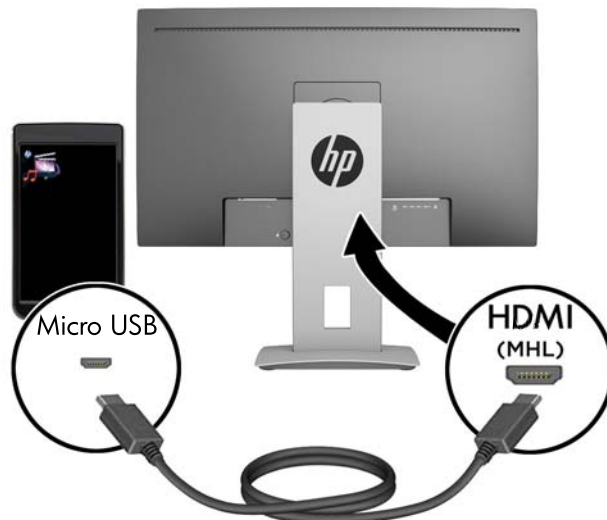

4. Connect the USB upstream cable's Type B connector to the USB upstream port on the rear of the monitor and the cable's Type A connector to the USB downstream port on the source device.

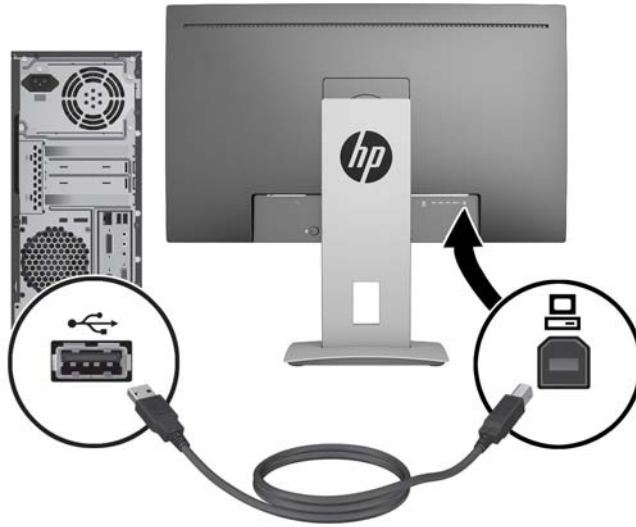

5. Connect one end of the provided audio cable to the audio connector on the monitor and connect the other end of the cable to an audio output connector on the rear panel of the source device.
6. Connect one end of the AC power cord to the power connector on the rear of the monitor, and the other end to an AC outlet.

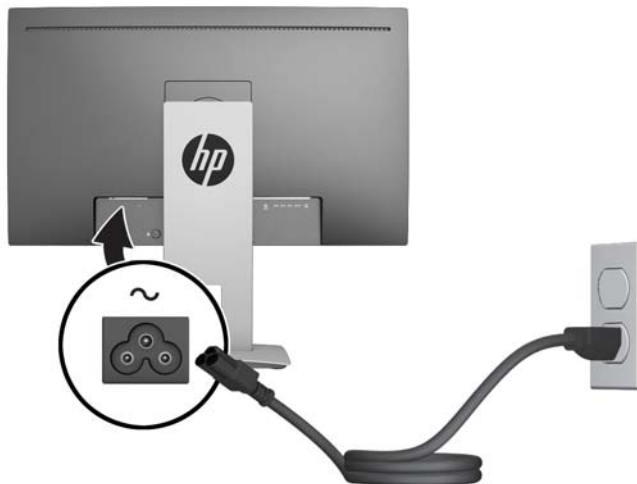

⚠ WARNING! To reduce the risk of electric shock or damage to the equipment:

Do not disable the power cord grounding plug. The grounding plug is an important safety feature. Plug the power cord into a grounded (earthed) electrical outlet that is easily accessible at all times. Disconnect power from the equipment by unplugging the power cord from the AC outlet.

For your safety, do not place anything on power cords or cables. Arrange them so that no one may accidentally step on or trip over them. Do not pull on a cord or cable. When unplugging from the electrical outlet, grasp the cord by the plug.

Front panel controls

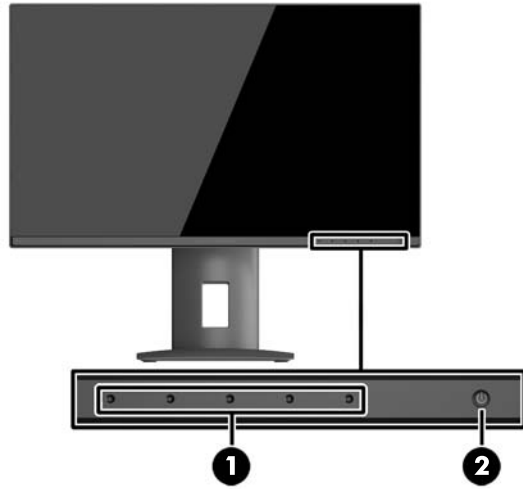

Control	Function
1	Function buttons Use these buttons to navigate through the OSD based on the indicators next to the buttons that are activated while the OSD is open.
2	Power button Turns the monitor on or off. NOTE: Be sure the master power switch on the rear of the monitor is in the ON position to turn on the monitor.

 **NOTE:** To view an OSD menu simulator, visit the HP Customer Self Repair Services Media Library at <http://www.hp.com/go/sml>.

Adjusting the monitor

1. Tilt the monitor's panel forward or backward to set it to a comfortable eye level.

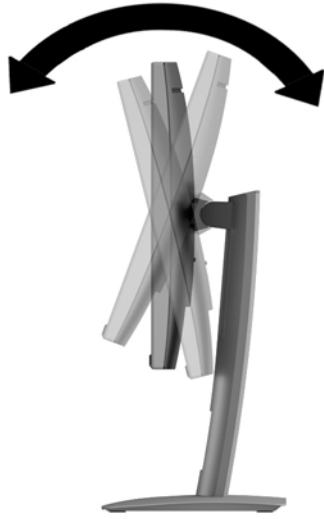

2. Swivel the monitor to the left or right for the best viewing angle.



3. Adjust the monitor's height to a comfortable position for your individual workstation. The monitor's top bezel edge should not exceed a height that is parallel to your eye height. A monitor that is positioned low and reclined may be more comfortable for users with corrective lenses. The monitor should be repositioned as you adjust your working posture throughout the work day.



4. You can pivot the monitor from landscape to portrait orientation viewing to adapt to your application.
 - a. Adjust the monitor to full height position and tilt the monitor back to full tilt position (1).
 - b. Pivot the monitor clockwise 90° or counterclockwise 90° from landscape to portrait orientation (2).

⚠ CAUTION: If the monitor is not in full height and full tilt position when pivoting, the bottom right corner of the monitor panel will come in contact with the base and potentially cause damage to the monitor.

If you are adding an optional speaker bar to the monitor, install it after pivoting the monitor. The speaker bar will come in contact with the base when pivoting and potentially cause damage to the monitor or speaker bar.



📝 NOTE: To view information on the screen in portrait mode, you can install the HP Display Assistant software included on the software and documentation disc. The position of the OSD menu can also be rotated to portrait mode. To rotate the OSD menu, access the OSD menu by pressing the **Menu** button on the front panel, select **OSD Control** from the menu, and then select **OSD Rotation**.

Turning on the monitor

1. Set the master power switch on the rear of the monitor to the On position.
2. Press the power button on the computer to turn it on.
3. Press the power button on the front of the monitor to turn it on.

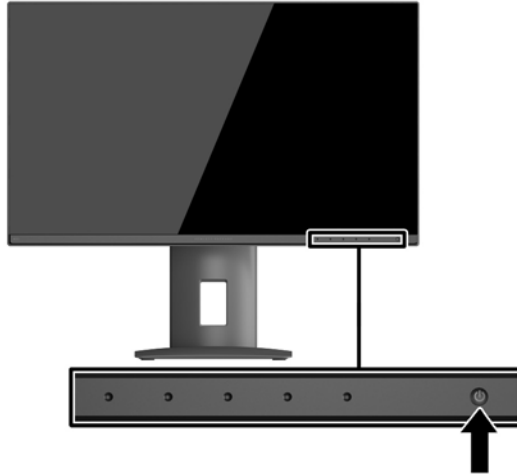

CAUTION: Burn-in image damage may occur on monitors that display the same static image on screen for a prolonged period of time.* To avoid burn-in image damage on the monitor screen, you should always activate a screen saver application or turn off the monitor when it is not in use for a prolonged period of time. Image retention is a condition that may occur on all LCD screens. Monitors with a “burned-in image” are not covered under the HP warranty.

* A prolonged period of time is 2 consecutive hours of a static image.

NOTE: If pressing the power button has no effect, the Power Button Lockout feature may be enabled. To disable this feature, press and hold the monitor power button for 10 seconds.



NOTE: You can disable the power LED in the OSD menu. Press the **Menu** button on the front of the monitor, and then select **Power Control > Power LED > Off**.

When the monitor is powered on, a Monitor Status message is displayed for five seconds. The message shows which input is the current active signal, the status of the auto-switch source setting (On or Off; factory default is On), the current preset display resolution, and the recommended preset display resolution.

The monitor automatically scans the signal inputs for an active input and uses that input for the display.

Connecting USB devices

USB ports are used to connect devices such as a digital camera, USB keyboard, or USB mouse. There are four downstream USB ports on the monitor. Three of the downstream USB ports provide standard USB connections. One of the downstream USB ports provides USB connection and fast charging for any USB battery-powered device.

Component	Icon	Function
USB 3.0 Standard Downstream Connectors (3)		Connects optional USB devices to the monitor.
USB 3.0 Downstream Fast Charge Connector (1)		Connects and charges optional USB battery-powered devices



NOTE: You must connect the USB upstream cable from the computer to the monitor to enable the USB downstream ports on the monitor. See step 4 in [Connecting the cables on page 8](#).



Removing the monitor stand

You can remove the monitor panel from the stand to install the panel on a wall, a swing arm, or other mounting fixture.

⚠ CAUTION: Before beginning to disassemble the monitor, be sure the monitor is turned off and all cables are disconnected.

1. Disconnect and remove all cables from the monitor.
2. Lay the monitor face down on a flat surface covered by a clean, dry cloth.
3. Push up on the latch near the bottom center of the monitor to unlock the HP Quick Release 2 (1).
4. Swing the bottom of the stand up until the mounting plate clears the recess in the panel (2).
5. Slide the stand out of the recess (3).

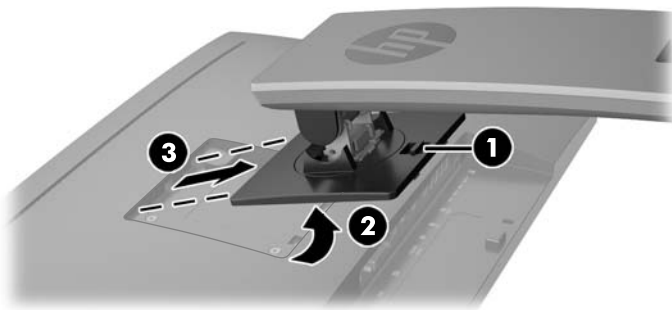

Mounting the monitor

The monitor panel can be attached to a wall, swing arm, or other mounting fixture.

📝 NOTE: This apparatus is intended to be supported by UL or CSA Listed wall mount bracket.

⚠ CAUTION: This monitor supports the VESA industry standard 100 mm mounting holes. To attach a third-party mounting solution to the monitor, four 4 mm, 0.7 pitch, and 10 mm long screws are required. Longer screws must not be used because they may damage the monitor. It is important to verify that the manufacturer's mounting solution is compliant with the VESA standard and is rated to support the weight of the monitor display panel. For best performance, it is important to use the power and video cables provided with the monitor.

Mounting the monitor to a fixture

To mount the monitor panel to a mounting fixture:

1. Remove the monitor from the stand. [Removing the monitor stand on page 17](#).

2. Remove the four screws from the VESA holes located on the rear of the monitor panel.

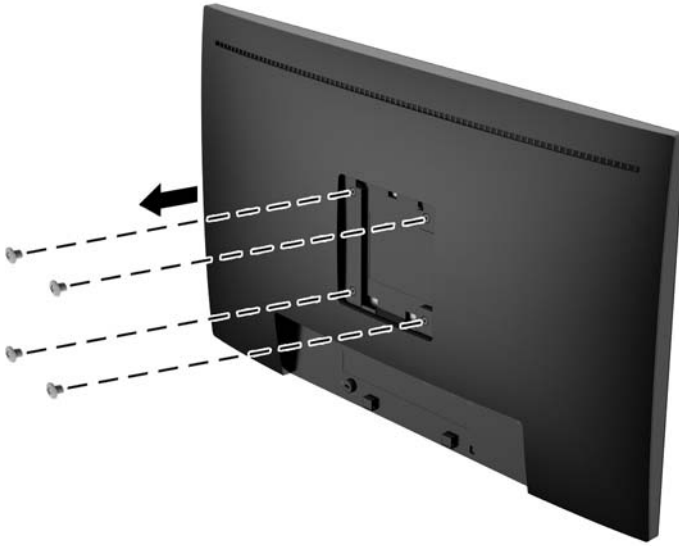

3. Install the mounting plate to the wall or swing arm of your choice using the four screws that were removed from the VESA holes on the rear of the monitor panel.

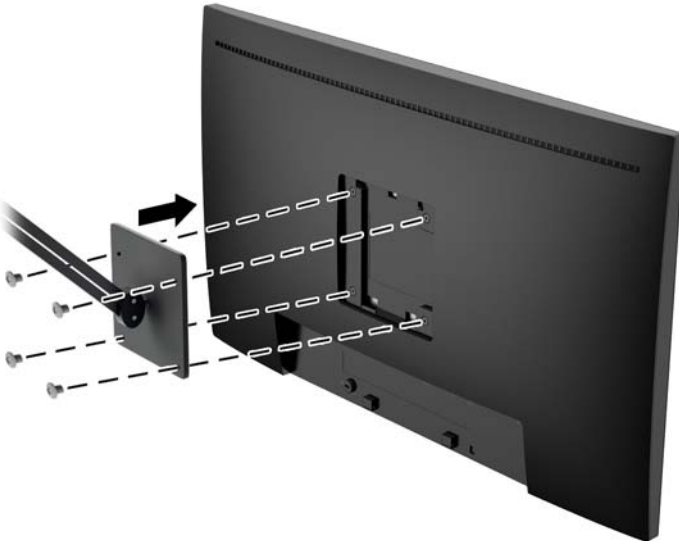

Locating the serial number and product number

The serial number and product number are located on a label on the rear panel of the display head. You may need these numbers when contacting HP about the monitor model.

 **NOTE:** You may need to partially pivot the display head to read the label.

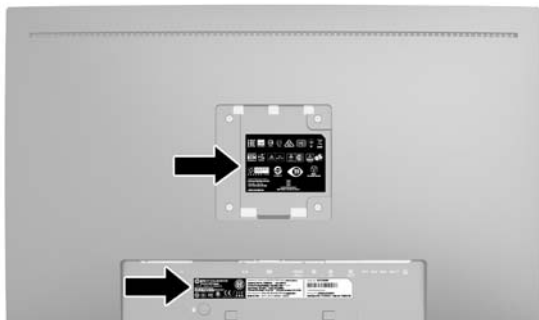

Installing a cable lock

You can secure the monitor to a fixed object with an optional cable lock available from HP.

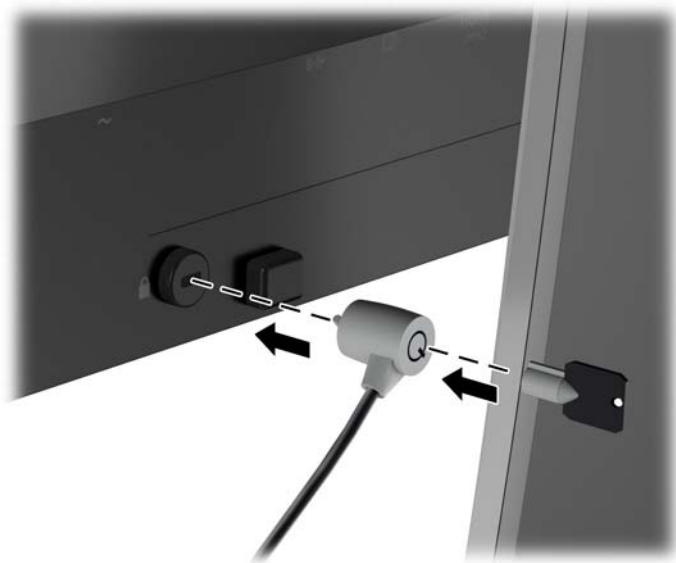

4 Operating the monitor

Software and utilities

The disc that comes with the monitor contains files you can install on the computer:

- an .INF (Information) file
- ICM (Image Color Matching) files (one for each calibrated color space)

The Information file

The .INF file defines monitor resources used by Microsoft Windows operating systems to ensure monitor compatibility with the computer's graphics adapter.

This monitor is Microsoft Windows Plug and Play compatible and the monitor will work correctly without installing the .INF file. Monitor Plug and Play compatibility requires that the computer's graphic card is VESA DDC2-compliant and that the monitor connects directly to the graphics card. Plug and Play does not work through separate BNC type connectors or through distribution buffers/boxes.

The Image Color Matching file

The .ICM files are data files that are used in conjunction with graphics programs to provide consistent color matching from monitor screen to printer, or from scanner to monitor screen. This file is activated from within graphics programs that support this feature.



NOTE: The ICM color profile is written in accordance with the International Color Consortium (ICC) Profile Format specification.

Installing the .INF and .ICM files

After you determine that you need to update, you can install the .INF and .ICM files from the disc or download them.

Installing from the disc

To install the .INF and .ICM files on the computer from the disc:

1. Insert the disc in the computer optical drive. The disc menu is displayed.
2. View the **HP Monitor Software Information** file.
3. Select **Install Monitor Driver Software**.
4. Follow the on-screen instructions.
5. Ensure that the proper resolution and refresh rates appear in the Windows Display control panel.



NOTE: You may need to install the digitally signed monitor .INF and .ICM files manually from the disc in the event of an installation error. Refer to the HP Monitor Software Information file on the disc.

Downloading from the Web

If you do not have a computer or source device with an optical drive, you can download the latest version of .INF and .ICM files from the HP monitors support Web site:

1. Go to <http://www.hp.com/support> and select the appropriate country and language.
2. Select **Drivers & Downloads**, type your monitor model in the **Find my product** search field, and click **Go**.
3. If necessary, select your monitor from the list.
4. Select your operating system, and then click **Next**.
5. Click **Driver - Display/Monitor** to open the list of drivers.
6. Click on the driver.
7. Click the **System Requirements** tab, and then verify that your system meets the program minimum requirements.
8. Click **Download** and follow the on-screen instructions to download the software.

Using the On-Screen Display (OSD) menu

Use the On-Screen Display (OSD) to adjust the monitor settings screen image based on your preferences. You can access and make adjustments in the OSD using the buttons on the monitor's front panel.

To access the OSD and make adjustments, do the following:

1. If the monitor is not already on, press the power button to turn on the monitor.
2. To access the OSD menu, press one of the five front bezel Functional buttons (except Power button) to activate the buttons, and then press the **Menu** button to open the OSD.
3. Use the five Function buttons to navigate, select, and adjust the menu choices. The button labels are variable depending on the menu or sub-menu that is active.

The following table lists the menu selections in the main menu.

Main Menu	Description
Luminance	Adjusts the brightness level of the screen.
Color Control	Selects and adjusts the screen color.
Input Control	Selects the video input signal.
Image Control	Adjusts the screen image.
PIP Control	Selects and adjusts the PIP image.
Power Control	Adjusts the power settings.
OSD Control	Adjusts the on-screen display (OSD) and Function button controls.
Management	Enables/disables DDC/CI support and returns all OSD menu settings to the factory default settings.
Language	Selects the language in which the OSD menu is displayed. The factory default is English.
Information	Displays important information about the monitor.
Exit	Exits the OSD menu screen.

Using Picture-in-Picture (PIP) and Picture-beside-Picture (PBP)

The monitor supports both PIP, where one source is overlaid over another, and PBP, where one source is positioned adjacent to another either horizontally (for landscape orientation) or vertically (for portrait orientation).

To use PIP or PBP:

1. Connect a secondary input source to the monitor.
2. Press one of the five front bezel Functional buttons to activate the buttons, and then press the **Menu** button to open the OSD.
3. In the OSD, select **PIP Control** > **PIP On/Off** and then select either **Picture-in-Picture** or **Picture-beside-Picture**.
4. The monitor will scan the secondary inputs for a valid input and use that input for the PIP/PBP picture. If you want to change the PIP/PBP input, select **PIP Input** in the OSD and select the desired input.
5. If you want to change the size of the PIP, select **PIP Size** in the OSD then select the desired size.
6. If you want to adjust the position of the PIP, select **PIP Position** in the OSD, then select the desired position.

DisplayPort Multistreaming

If you are using DisplayPort as the primary video input source, you can multistream to other DisplayPort monitors connected in a daisy chain configuration. You can connect up to four monitors in this configuration if supported by the graphics card.

To use DisplayPort multistreaming:

1. Make sure that DisplayPort is used for your primary video input.
2. Add a second monitor by connecting a DisplayPort cable between the DisplayPort OUT connector on the primary monitor and the DisplayPort IN connector on a secondary multistream monitor or the DisplayPort input connector on a secondary non-multistream monitor.

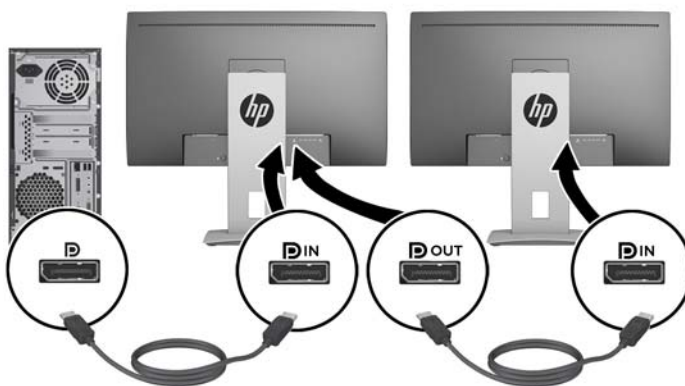

3. You can set the connected monitor to display the same image as the primary monitor or a different image. In the OSD for the connected monitor, select **Management** > **DisplayPort Output** and select one of the following:

- a. **DisplayPort 1.1 Compatibility Mode** (default) - allows the same video image to be sent to all monitors downstream of the monitor you are configuring
 - b. **DisplayPort 1.2** - allows a different image to be sent to all monitors downstream of the monitor you are configuring
4. After setting the DisplayPort Compatibility Mode in the OSD, use the computer operating system's display settings to set the display mode for the secondary monitor to either mirror the image of the primary display or extend the second display for a different image from the primary display.

If you wish to connect additional monitors downstream (up to four maximum), all but the final monitor in the chain must support DisplayPort multistreaming.

Connect from the DisplayPort OUT of one monitor to the DisplayPort IN of the next, until you have the desired number of displays.

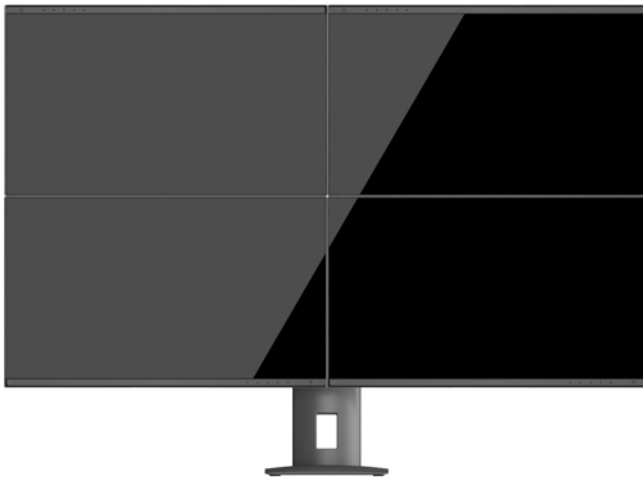

If you want different information on each screen be sure that all upstream monitors are configured to DisplayPort 1.2 mode, as described above.

The number of monitors you can connect through DisplayPort multistreaming depends on a number of factors, including the resolutions and scan rates used for each monitor and the capabilities of your GPU or embedded graphics system. Check the manual that came with your graphics card for further information on its capabilities.

Resolution	Multistreaming Maximum Displays Quantity
1280 x 720	4
1600 x 900	4
1920 x 1080	4
1920 x 1200	2
2560 x 1440	2

Using Auto-Sleep Mode

The display supports an OSD (On-Screen Display) option called **Auto-Sleep Mode** that allows you to enable or disable a reduced power state for the display. When Auto-Sleep Mode is enabled (enabled by default), the monitor will enter a reduced power state when the host PC signals low power mode (absence of either horizontal or vertical sync signal).

Upon entering this reduced power state sleep mode, the monitor screen is blanked, the backlight is turned off and the power LED indicator turns amber. The monitor draws less than 0.5W of power when in this reduced power mode. The monitor will wake from the sleep mode when the host PC sends an active signal to the monitor (for example, if you activate the mouse or keyboard).

You can disable the Auto-Sleep Mode in the OSD. Press one of the five front bezel Functional buttons to activate the buttons, and then press the **Menu** button to open the OSD. In the OSD press **Power Control > Auto-Sleep Mode > Disable**.

A Technical specifications



NOTE: All specifications represent the typical specifications provided by HP's component manufacturers; actual performance may vary either higher or lower.

For the latest specifications or additional specifications on this product, go to <http://www.hp.com/go/quickspecs/> and search for your specific display model to find the model-specific QuickSpecs.

23.8-inch Full HD/QHD Models

Display	60 cm wide screen	23.8 inches wide screen
Type	TFT-LCD	
Viewable Image Size	60 cm diagonal	23.8-inch diagonal
Maximum Weight (Unpacked)	Full HD 5.2 ± 0.25 kg QHD 5.5 ± 0.25 kg	Full HD 11.45 ± 0.55 lbs QHD 12.11 ± 0.55 lbs
Dimensions (include base)		
Height (highest position)	50.56 cm	19.91 inches
Height (lowest position)	37.56 cm	14.79 inches
Depth	21.02 cm	8.28 inches
Width	54.06 cm	21.28 inches
Maximum Graphic Resolution	1920 x 1080 (60 Hz) (Full HD) 2560 x 1440 (60 Hz) (QHD)	
Optimum Graphic Resolution	1920 x 1080 (60 Hz) (Full HD) 2560 x 1440 (60 Hz) (QHD)	
Environmental Requirements Temperature		
Operating Temperature	5 to 35° C	41 to 95° F
Storage Temperature	-20 to 60° C	-4 to 140° F
Power Source	100 – 240 VAC 50/60 Hz	
Input Terminal	One HDMI/MHL connector, one DisplayPort connector, one Mini-DisplayPort connector, one DVI connector (cable inclusion varies by region)	

24-inch Model

Display	61 cm wide screen	24 inches wide screen
Type	TFT-LCD	
Viewable Image Size	61 cm diagonal	24-inch diagonal
Maximum Weight (Unpacked)	5.6 ± 0.25 kg	12.35 ± 0.55 lbs
Dimensions (include base)		
Height (highest position)	52.02 cm	20.481 inches
Height (lowest position)	39.02 cm	15.36 inches
Depth	21.02 cm	8.28 inches
Width	53.38 cm	21.02 inches
Maximum Graphic Resolution	1920 x 1200 (60 Hz)	
Optimum Graphic Resolution	1920 x 1200 (60 Hz)	
Environmental Requirements Temperature		
Operating Temperature	5 to 35° C	41 to 95° F
Storage Temperature	-20 to 60° C	-4 to 140° F
Power Source	100 – 240 VAC 50/60 Hz	
Input Terminal	One HDMI/MHL connector, one DisplayPort connector, one Mini-DisplayPort connector, one DVI connector (cable inclusion varies by region)	

25-inch QHD Model

Display	63.44 cm wide screen	24.98 inches wide screen
Type	LCD	
Viewable Image Size	55.30 x 31.10 cm	21.77 x 12.24 inches
Maximum Weight (Unpacked)	7.06 kg	15.56 lbs
Dimensions (include base)		
Height (highest position)	52.15 cm	20.53 inches
Height (lowest position)	39.15 cm	15.41 inches
Depth	21.82 cm	8.59 inches
Width	57.05 cm	22.46 inches
Maximum Graphic Resolution	2560 x 1440 (60 Hz)	
Optimum Graphic Resolution	2560 x 1440 (60 Hz)	
Environmental Requirements Temperature		
Operating Temperature	5 to 35° C	41 to 95° F

Storage Temperature	-20 to 60° C	-4 to 140° F
Power Source	100 – 240 VAC 50/60 Hz	
Input Terminal	One HDMI/MHL connector, one DisplayPort connector, one Mini-DisplayPort connector, one DVI connector (cable inclusion varies by region)	

27-inch QHD Model

Display	68.47 cm wide screen	27 inches wide screen
Type	LCD	
Viewable Image Size	59.67 x 33.57 cm	23.49 x 13.22 inches
Maximum Weight (Unpacked)	7.66 kg	16.89 lbs
Dimensions (include base)		
Height (highest position)	53.37 cm	21.01 inches
Height (lowest position)	40.37 cm	15.89 inches
Depth	21.82 cm	8.59 inches
Width	61.43 cm	24.16 inches
Maximum Graphic Resolution	2560 x 1440 (60 Hz)	
Optimum Graphic Resolution	2560 x 1440 (60 Hz)	
Environmental Requirements Temperature		
Operating Temperature	5 to 35° C	41 to 95° F
Storage Temperature	-20 to 60° C	-4 to 140° F
Power Source	100 – 240 VAC 50/60 Hz	
Input Terminal	One HDMI/MHL connector, one DisplayPort connector, one Mini-DisplayPort connector, one DVI connector (cable inclusion varies by region)	

Recognizing Preset Display Resolutions

The display resolutions listed below are the most commonly used modes and are set as factory defaults. This monitor automatically recognizes these preset modes and they will appear properly sized and centered on the screen.

23.8-inch Full HD Model

Preset	Pixel Format	Horz Freq (kHz)	Vert Freq (Hz)
1	640 × 480	31.469	59.940
2	800 × 600	37.879	60.317
3	1024 × 768	48.363	60.004
4	1280 × 720	45.000	59.940
5	1280 × 800	49.702	59.810
6	1280 × 1024	63.981	60.020
7	1366 × 768	47.712	59.790
8	1440 × 900	55.935	59.887
9	1600 × 900	60.000	60.000
10	-	-	-
11	1680 × 1050	65.290	59.954
12	1920 × 1080	67.5	60.00

24-inch Model

Preset	Pixel Format	Horz Freq (kHz)	Vert Freq (Hz)
1	640 × 480	31.469	59.940
2	800 × 600	37.879	60.317
3	1024 × 768	48.363	60.004
4	1280 × 720	45.000	59.940
5	1280 × 800	49.702	59.810
6	1280 × 1024	63.981	60.020
7	1366 × 768	47.712	59.790
8	1440 × 900	55.935	59.887
9	1600 × 900	60.000	60.000
10	1600 × 1200	75.000	60.000
11	1680 × 1050	65.290	59.954
12	1920 × 1080	67.500	60.000
13	1920 × 1200	74.038	59.950

23.8-inch QHD/25-inch/27-inch Models

Preset	Pixel Format	Horz Freq (kHz)	Vert Freq (Hz)
1	640 × 480	31.469	59.940
2	-	-	-
3	800 × 600	37.879	60.317
4	1024 × 768	48.363	60.004
5	1280 × 720	45.000	60.000
6	1280 × 800	49.702	59.810
7	1280 × 1024	63.981	60.020
8	1366 × 768	48.000	60.000
9	1440 × 900	55.935	59.887
10	1600 × 900	60.000	60.000
11	1600 × 1200	75.000	60.000
12	1680 × 1050	65.290	59.954
13	1920 × 1080	67.500	60.000
14	1920 × 1200	74.038	59.950
15	1920 × 1200	74.556	59.885
16	2560 × 1440	88.787	59.951

High Definition Video Formats

Preset	Timing Name	Pixel Format	Horz Freq (kHz)	Vert Freq (Hz)
1	480p	640 × 480	31.469	59.940
2	480p	720 × 480	31.469	59.940
3	720p60	1280 × 720	45.000	60.000
4	576p	720 × 576	31.250	50.000
5	720p50	1280 × 720	37.500	50.000
6*	1080i60	1920 × 1080	33.750	60.000
7*	1080i50	1920 × 1080	28.125	50.000
8	1080p60	1920 × 1080	67.500	60.000
9	1080p50	1920 × 1080	56.250	50.000
10	1080p30	1920 × 1080	33.750	30.000

* For HDMI input only

B Support and troubleshooting

Solving common problems

The following table lists possible problems, the possible cause of each problem, and the recommended solutions.

Problem	Possible Cause	Solution
Screen is blank or video is flashing.	Power cord is disconnected.	Connect the power cord.
	Power button is turned off.	Press the front panel power button. NOTE: If pressing the power button has no effect, press and hold the power button for 10 seconds to disable the power button lockout feature.
	Video cable is improperly connected.	Connect the video cable properly. See Connecting the cables on page 8 for more information.
	System is in sleep mode.	Press any key on the keyboard or move the mouse to inactivate the screen blanking utility.
Image appears blurred, indistinct, or too dark.	Video card compatibility.	Open the OSD menu and select the Input Control menu. Set Auto-Switch Input to Off and manually select the input.
	Brightness is too low.	Open the OSD menu and select Brightness to adjust the brightness scale as needed.
Check Video Cable is displayed on screen.	Monitor video cable is disconnected.	Connect the appropriate video signal cable between the computer and monitor. Be sure that the computer power is off while connecting the video cable.
Input Signal Out of Range is displayed on screen.	Video resolution and/or refresh rate are set higher than what the monitor supports.	Change the settings to a supported setting (see Recognizing Preset Display Resolutions on page 28).
The monitor is off but it did not seem to enter into a low-power sleep mode.	The monitor's power saving control is disabled.	Open the OSD menu and select Power Control > Auto-Sleep Mode and set auto-sleep to On .
OSD Lockout is displayed.	The monitor's OSD Lockout function is enabled.	Press and hold the Menu button on the front panel for 10 seconds to disable the OSD Lockout function.
Power Button Lockout is displayed.	The monitor's Power Button Lockout function is enabled.	Press and hold the power button for 10 seconds to unlock the power button function.

Button lockouts

Holding down the power button or **Menu** button for ten seconds will lock out the functionality of that button. You can restore the functionality by holding the button down again for ten seconds. This functionality is only available when the display is powered on, displaying an active signal, and the OSD is not active.

Product support

For additional information on using your monitor, go to <http://www.hp.com/support>. Select your country or region, select **Troubleshooting**, and then enter your model in the search window and click the **Go** button.



NOTE: The monitor user guide, reference material, and drivers are available at <http://www.hp.com/support>.

If the information provided in the guide does not address your questions, you can contact support. For U.S. support, go to <http://www.hp.com/go/contactHP>. For worldwide support, go to http://welcome.hp.com/country/us/en/wwcontact_us.html.

Here you can:

- Chat online with an HP technician



NOTE: When support chat is not available in a particular language, it is available in English.

- Find support telephone numbers
- Locate an HP service center

Preparing to call technical support

If you cannot solve a problem using the troubleshooting tips in this section, you may need to call technical support. Have the following information available when you call:

- Monitor model number
- Monitor serial number
- Purchase date on invoice
- Conditions under which the problem occurred
- Error messages received
- Hardware configuration
- Name and version of the hardware and software you are using

C LCD monitor quality and pixel policy

The TFT monitor uses high-precision technology, manufactured according to HP standards, to guarantee trouble-free performance. Nevertheless, the display may have cosmetic imperfections that appear as small bright or dark spots. This is common to all LCD displays used in products supplied by all vendors and is not specific to the HP LCD. These imperfections are caused by one or more defective pixels or sub-pixels.

- A pixel consists of one red, one green, and one blue sub-pixel.
- A defective whole pixel is always turned on (a bright spot on a dark background), or it is always off (a dark spot on a bright background). The first is the more visible of the two.
- A defective sub-pixel (dot defect) is less visible than a defective whole pixel and is small and only visible on a specific background.

To locate defective pixels, the monitor should be viewed under normal operating conditions, in normal operating mode at a supported resolution and refresh rate, from a distance of approximately 50 cm (20 in).

HP expects that, over time, the industry will continue to improve its ability to produce LCDs with fewer cosmetic imperfections and HP will adjust guidelines as improvements are made.

D Accessibility

HP designs, produces, and markets products and services that can be used by everyone, including people with disabilities, either on a stand-alone basis or with appropriate assistive devices.

Supported assistive technologies

HP products support a wide variety of operating system assistive technologies and can be configured to work with additional assistive technologies. Use the Search feature on your device to locate more information about assistive features.



NOTE: For additional information about a particular assistive technology product, contact customer support for that product.

Contacting support

We are constantly refining the accessibility of our products and services and welcome feedback from users. If you have an issue with a product or would like to tell us about accessibility features that have helped you, please contact us at (888) 259-5707, Monday through Friday, 6 a.m. to 9 p.m. Mountain Time. If you are deaf or hard-of-hearing and use TRS/VRS/WebCapTel, contact us if you require technical support or have accessibility questions by calling (877) 656-7058, Monday through Friday, 6 a.m. to 9 p.m. Mountain Time.