

BOSE

ACOUSTIMASS® 300

WIRELESS BASS MODULE



OWNER'S GUIDE • BRUGERVEJLEDNING
BEDIENUNGSANLEITUNG • GEBRUIKERSHANDLEIDING
GUÍA DEL USUARIO • KÄYTTÖOHJE • NOTICE D'UTILISATION
MANUALE DI ISTRUZIONI • KEZELÉSI ÚTMUTATÓ
BRUKERVEILEDNING • PODRĘCZNIK UŻYTKOWNIKA
MANUAL DO PROPRIETÁRIO • BRUKSANVISNING
คู่มือผู้ใช้ • 사용자 안내서 • 用户指南 • 使用者指南 • 取扱説明書 • دليل المالك

IMPORTANT SAFETY INSTRUCTIONS

Please read and keep all safety and use instructions.

Important Safety Instructions

1. Read these instructions.
2. Keep these instructions.
3. Heed all warnings.
4. Follow all instructions.
5. Do not use this apparatus near water.
6. Clean only with a dry cloth.
7. Do not block any ventilation openings. Install in accordance with the manufacturer's instructions.
8. Do not install near any heat sources such as radiators, heat registers, stoves, or other apparatus (including amplifiers) that produce heat.
9. Protect the power cord from being walked on or pinched particularly at plugs, convenience receptacles, and the point where they exit from the apparatus.
10. Only use attachments/accessories specified by the manufacturer.
11. Unplug this apparatus during lightning storms or when unused for long periods of time.
12. Refer all servicing to qualified personnel. Servicing is required when the apparatus has been damaged in any way, such as power-supply cord or plug is damaged, liquid has been spilled or objects have fallen into the apparatus, the apparatus has been exposed to rain or moisture, does not operate normally, or has been dropped.

IMPORTANT SAFETY INSTRUCTIONS

WARNINGS/CAUTIONS:



This symbol on the product means there is uninsulated, dangerous voltage within the product enclosure that may present a risk of electrical shock.



This symbol on the product means there are important operating and maintenance instructions in this guide.



This product contains a tempered glass surface. Use caution to avoid impact. In the event of breakage, use care in handling broken glass.



This product contains magnetic material. Consult your physician on whether this might affect your implantable medical device.

- To reduce the risk of fire or electrical shock, do NOT expose this product to rain, liquids or moisture.
- Do NOT expose this product to dripping or splashing, and do not place objects filled with liquids, such as vases, on or near the product.
- Keep the product away from fire and heat sources. Do NOT place naked flame sources, such as lighted candles, on or near the product.
- Do NOT make unauthorized alterations to this product.
- Do NOT use a power inverter with this product.
- Do NOT use in vehicles or boats.
- The speaker wire and interconnect cables included with this system are not approved for in-wall installation. Please check your local building codes for the correct type of wire and cable required for in-wall installation.
- Where the mains plug or an appliance coupler is used as the disconnect device, the disconnect device shall remain readily operable.



仅适用于 2000m 以下地区安全使用
Use at altitude less than 2000 meters only.

- Due to ventilation requirements, Bose does not recommend placing the product in a confined space such as in a wall cavity or in an enclosed cabinet.
- The product label is located on the bottom of the product.

REGULATORY INFORMATION

This device complies with part 15 of the FCC Rules and with Industry Canada license-exempt RSS standard(s). Operation is subject to the following two conditions: (1) This device may not cause harmful interference, and (2) this device must accept any interference received, including interference that may cause undesired operation

This device complies with FCC and Industry Canada radiation exposure limits set forth for general population.

This equipment should be installed and operated with a minimum distance of 20 cm between radiator and your body. This transmitter must not be co-located or operating in conjunction with any other antenna or transmitter.

This device for operation in the 5150 - 5250 MHz is only for indoor use to reduce the potential for harmful interference to co-channel mobile satellite systems.

W52 Indoor Only

Receiver Category = 2

Meets IDA Requirements.

CAN ICES-3 (B)/NMB-3(B)

Management Regulation for Low-power Radio-frequency Devices

Article XII

According to "Management Regulation for Low-power Radio-frequency Devices" without permission granted by the NCC, any company, enterprise, or user is not allowed to change frequency, enhance transmitting power or alter original characteristic as well as performance to an approved low power radio-frequency devices.

Article XIV

The low power radio-frequency devices shall not influence aircraft security and interfere legal communications; If found, the user shall cease operating immediately until no interference is achieved. The said legal communications means radio communications operated in compliance with the Telecommunications Act.

The low power radio-frequency devices must be susceptible with the interference from legal communications or ISM radio wave radiated devices.

 Bose Corporation hereby declares that this product is in compliance with the essential requirements and other relevant provisions of Directive 1999/5/EC and all other EU directive requirements. The complete declaration of conformity can be found at: www.Bose.com/compliance

 This symbol means the product must not be discarded as household waste, and should be delivered to an appropriate collection facility for recycling. Proper disposal and recycling helps protect natural resources, human health and the environment. For more information on disposal and recycling of this product, contact your local municipality, disposal service, or the shop where you bought this product.

REGULATORY INFORMATION

Names and Contents of Toxic or Hazardous Substances or Elements						
Part Name	Toxic or Hazardous Substances and Elements					
	Lead (Pb)	Mercury (Hg)	Cadmium (Cd)	Hexavalent (CR(VI))	Polybrominated Biphenyl (PBB)	Polybrominated diphenylether (PBDE)
PCBs	X	0	0	0	0	0
Metal Parts	X	0	0	0	0	0
Plastic Parts	0	0	0	0	0	0
Speakers	X	0	0	0	0	0
Cables	X	0	0	0	0	0
This table is prepared in accordance with the provisions of SJ/T 11364. O: Indicates that this toxic or hazardous substance contained in all of the homogeneous materials for this part is below the limit requirement of GB/T 26572. X: Indicates that this toxic or hazardous substance contained in at least one of the homogeneous materials used for this part is above the limit requirement of GB/T 26572.						

The *Bluetooth*[®] word mark and logos are registered trademarks owned by Bluetooth SIG, Inc. and any use of such marks by Bose Corporation is under license.



The terms HDMI and HDMI High-Definition Multimedia Interface, and the HDMI logo are trademarks or registered trademarks of HDMI Licensing LLC in the United States and other countries.

SoundTouch and the wireless note design are registered trademarks of Bose Corporation in the U.S. and other countries.

©2016 Bose Corporation. No part of this work may be reproduced, modified, distributed or otherwise used without prior written permission.

CONTENTS

Getting Started

Building your entertainment system.....	7
Unpacking.....	7
Placement guidelines	8

Setting Up the Bass Module

Connecting to power.....	9
Pairing with a SoundTouch® 300 soundbar.....	10

Finishing Setup

Checking for sound.....	11
About ADAPTiQ® audio calibration	12
Running ADAPTiQ® audio calibration.....	12

Using the Bass Module

Adjusting the bass setting.....	14
---------------------------------	----

Gathering System Information

System status indicators	16
--------------------------------	----

Care and Maintenance

Cleaning.....	17
Customer service	17
Limited warranty information	18
Technical information.....	18
Service connectors.....	18

Troubleshooting

Common solutions	19
Unable to complete ADAPTiQ® audio calibration	21
Unable to pair bass module with soundbar	22

Building your entertainment system

The Acoustimass® 300 wireless bass module is part of a modular home entertainment system, and is compatible with the SoundTouch® 300 soundbar and optional Virtually Invisible® 300 wireless surround speakers (not provided). You can wirelessly pair the surround speakers at any time for even richer, more immersive sound.

To purchase the surround speakers, contact your local Bose® dealer or visit www.Bose.com

Unpacking

Carefully unpack the carton and confirm that the following parts are included:

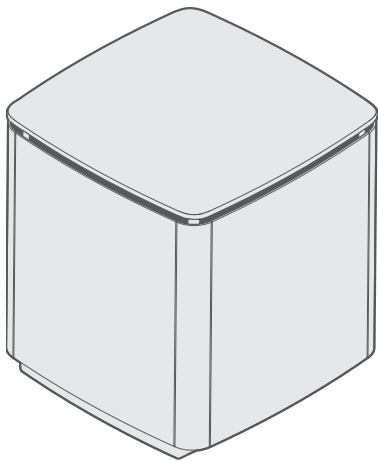

Acoustimass® 300 wireless bass module

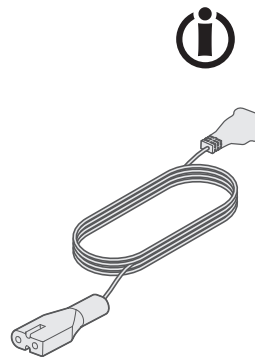

Power cord

 May ship with multiple power cords. Use the power cord for your region.

Note: If any part is damaged or if the glass on the bass module is broken, do not use it. Contact your authorized Bose® dealer or Bose customer service. Refer to the contact sheet in the carton.

Placement guidelines

To avoid wireless interference, keep other wireless equipment 1 – 3 ft. (0.3 – 0.9 m) away from the system. Place the system outside of and away from metal cabinets, other audio/video components and direct heat sources.

- Stand the bass module on its rubber feet along the same wall as your TV, or along any other wall in the front third of the room.
- Choose a stable and level surface. Vibration can cause the bass module to move, particularly on smooth surfaces like marble, glass or highly polished wood.
- Keep the front side of the bass module (the side opposite the POWER connector) at least 3 in. (7.6 cm) from any other surface. Blocking the port on the bottom of this side affects acoustic performance.
- For more bass, place the bass module close to walls and corners. For less bass, place the bass module away from walls and corners.
- Do NOT place any objects on top of the bass module.
- Make sure there is an AC (mains) outlet nearby.

Sample system placement

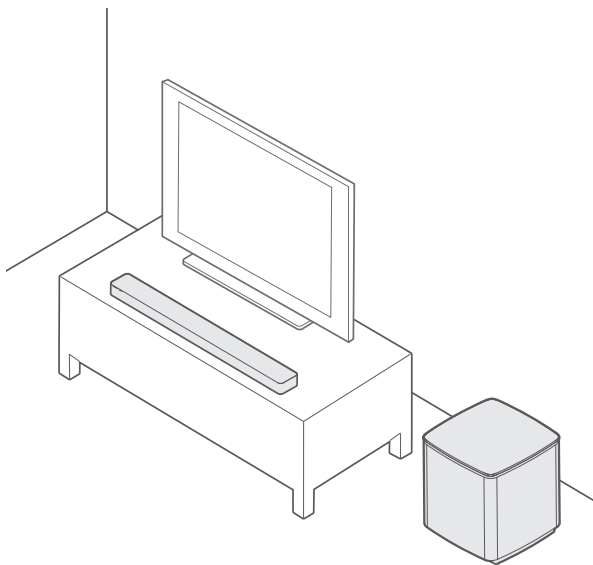

CAUTION: Do not place the bass module on its top or sides when in use.

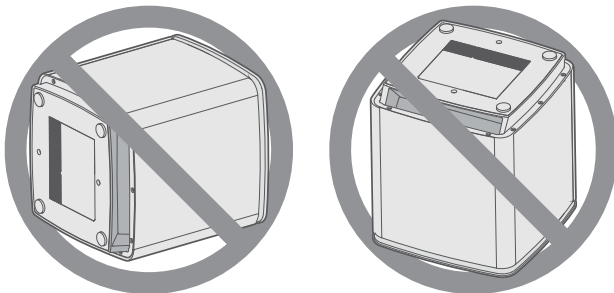

Connecting to power

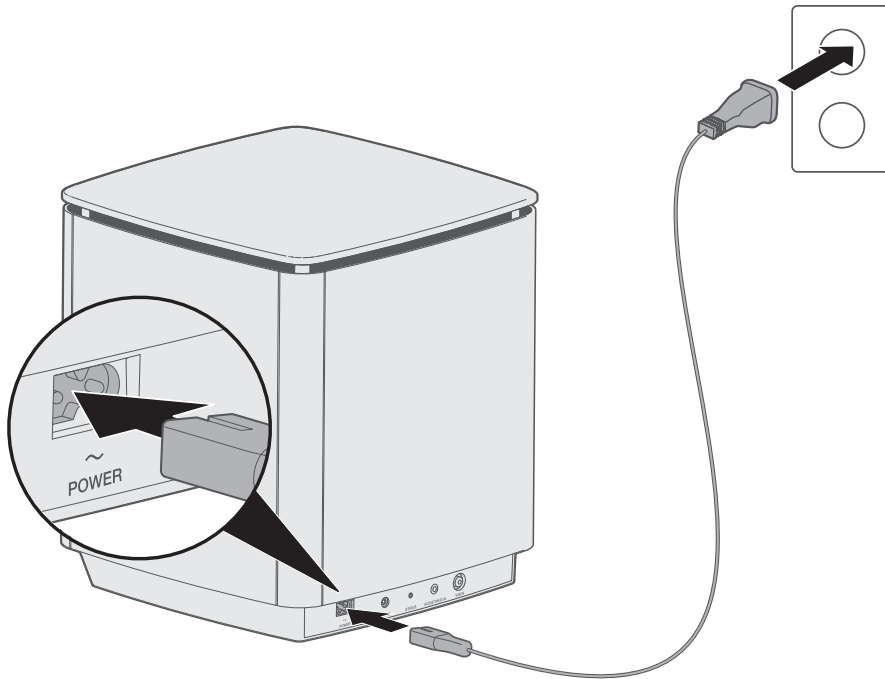

1. Plug the power cord into the **POWER** connector on the bass module.





2. Plug the other end of the power cord into an AC (mains) power outlet.

Pairing with a SoundTouch® 300 soundbar

To wirelessly pair the bass module with a SoundTouch® 300 soundbar, you need to place the soundbar into pairing mode using the remote control.

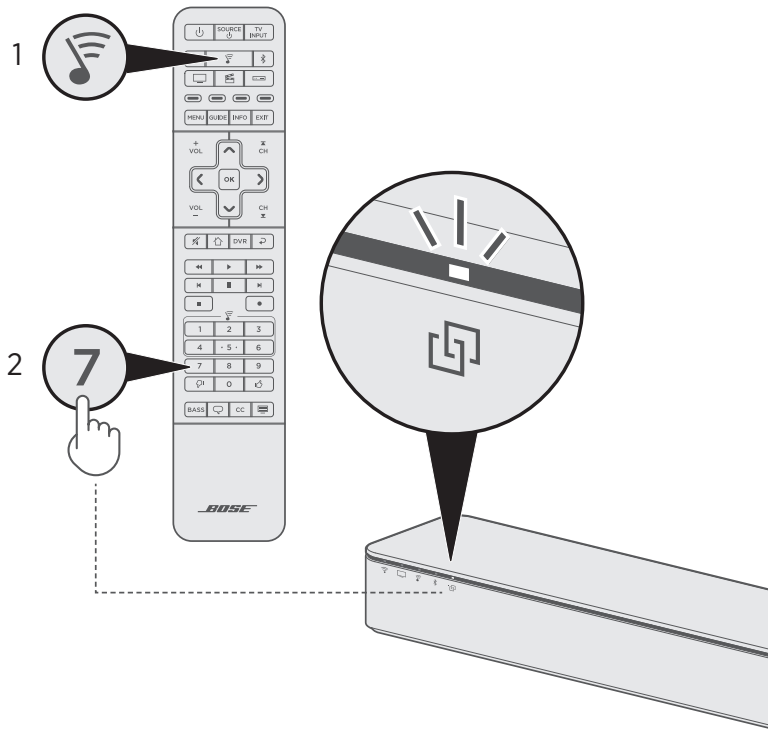
1. On the SoundTouch® 300 remote control, press the SoundTouch® button .
2. Press and hold **7** until the connectivity indicator  on the soundbar blinks white.



Once paired, the bass module emits a tone. The STATUS indicator on the back of the module and  on the soundbar glow white.

Note: If the bass module doesn't pair with the soundbar, see "Troubleshooting" on page 19.

Checking for sound

1. Power on your TV.
2. If you are using a cable/satellite box or other secondary source:
 - Power on this source.
 - If your secondary source is connected to your TV, select the appropriate TV input. If you have not programmed the SoundTouch® 300 remote control, you may need to use a different remote control.
3. Power on your SoundTouch® 300 soundbar.

You should hear sound coming from the bass module.

Note: If you do not hear sound from the bass module, see “Troubleshooting” on page 20.

About ADAPTiQ® audio calibration

After setting up your bass module and pairing with a SoundTouch® 300 soundbar, run ADAPTiQ® audio calibration for best acoustic performance. ADAPTiQ audio calibration customizes the sound of the system to the acoustics of your listening area by taking five audio measurements. To run an audio calibration, you need 10 minutes when the room is quiet.

During ADAPTiQ audio calibration, a microphone on the top of the ADAPTiQ headset (provided with the soundbar) measures the sound characteristics of your room to determine optimal sound quality.



If you no longer have the ADAPTiQ headset, contact Bose® customer service for a replacement. Refer to the contact sheet in the carton.

Note: If you are also pairing Virtually Invisible® 300 wireless surround speakers with the soundbar, pair the speakers before running ADAPTiQ audio calibration. Refer to the Virtually Invisible® 300 quick start guide or owner's guide.

Running ADAPTiQ® audio calibration

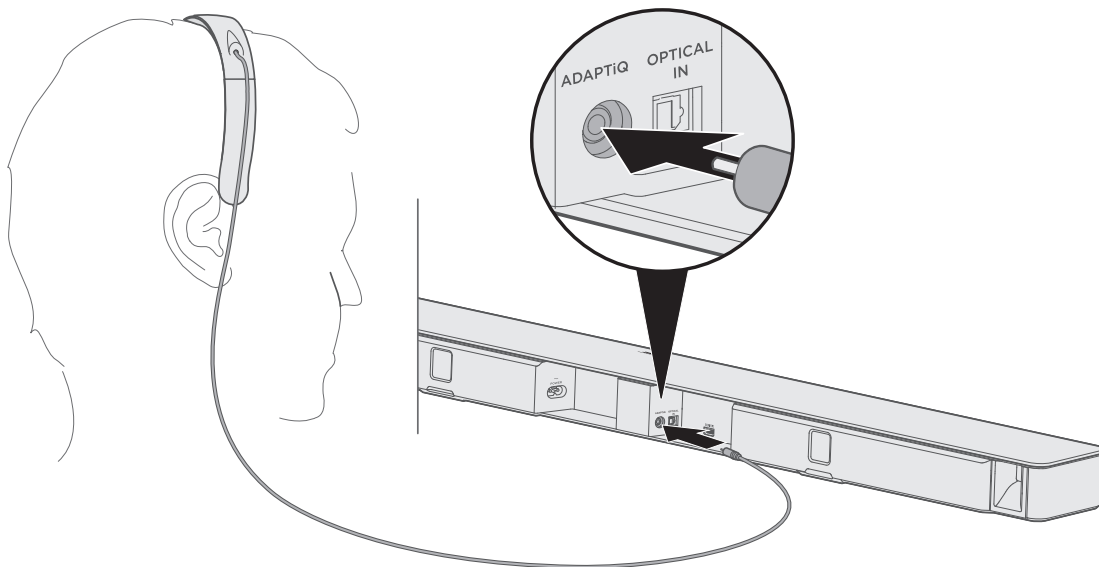

1. Put the ADAPTiQ headset (provided with the SoundTouch® 300 soundbar) on your head.
2. Insert the ADAPTiQ headset cable into the **ADAPTiQ** connector on the back of the soundbar.

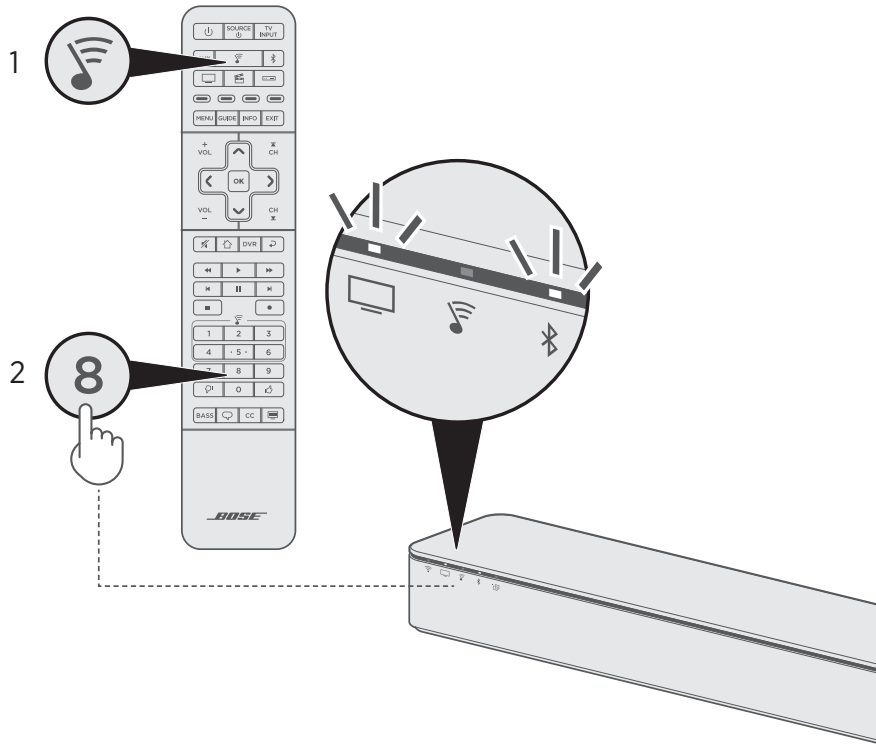

3. On the SoundTouch® 300 remote control, press the SoundTouch® button .
4. Press and hold **8** until the TV indicator  and the *Bluetooth*® indicator  on the soundbar glow green.



The ADAPTiQ® process begins.

Note: If you don't hear your language, press  and  on the navigation pad to cycle through languages. To reset the language, press and hold **8** for 10 seconds.

5. Follow the voice prompts until the ADAPTiQ process is complete.
If you hear an error message and are unable to complete ADAPTiQ audio calibration, see page 21.
6. Unplug the ADAPTiQ headset from the soundbar and store it in a safe place.
If you later pair the surround speakers, move or mount the system or move any furniture, run ADAPTiQ audio calibration again to ensure optimal sound quality.

Adjusting the bass setting

You can adjust the system's bass setting using the SoundTouch® app or the remote control. For details on the SoundTouch® app, refer to the SoundTouch® 300 owner's guide.

1. On the SoundTouch® 300 remote control, press **BASS**.

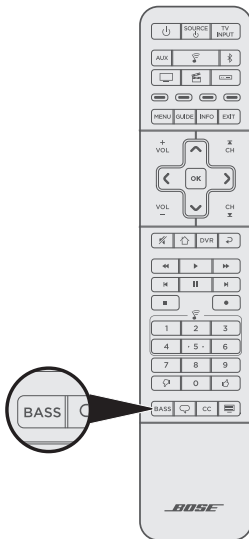

The indicators on the soundbar glow to show the current bass setting, as shown below.

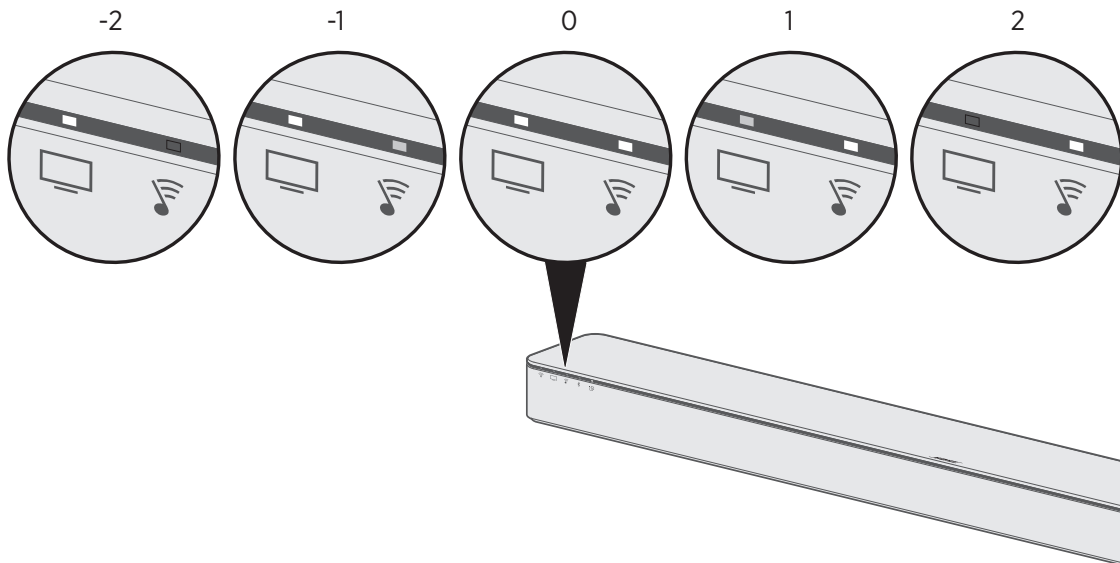



2. On the remote control:
 - Press **vol**⁺ to increase the bass.
 - Press **vol**₋ to decrease the bass.
3. Press **BASS**.

The soundbar saves your settings.

Note: For optimal sound quality for dialogue-only programs, such as news and talk shows, enable dialogue mode. For more information, refer to the SoundTouch® 300 owner's guide.

Resetting the bass setting

On the remote control, press and hold **BASS** until the TV indicator  and the *Bluetooth*® indicator  on the soundbar blink twice.

The bass setting resets to original factory settings.

System status indicators

The STATUS indicator on the back of the module shows system status.

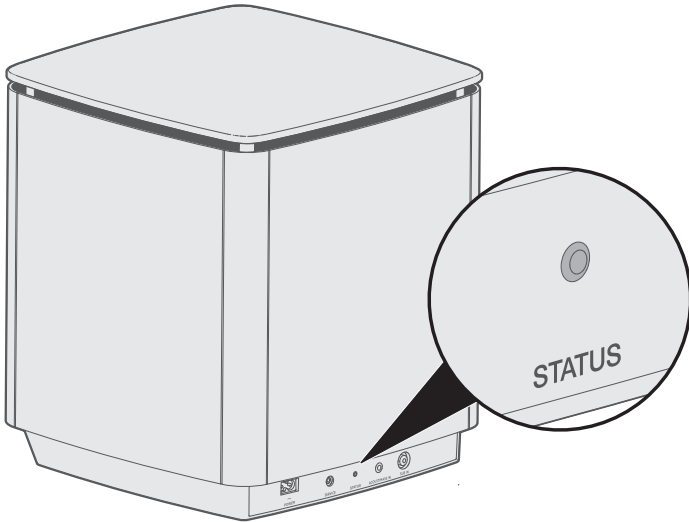

Indicator activity	System state
Solid white	Connected to the soundbar
Blinking white	Downloading system software update
Solid amber (dim)	Disconnected from the soundbar
Blinking amber	Ready to pair
Blinking red	Firmware error - contact Bose® customer service

Cleaning



Do not allow liquids to spill onto the system or into any openings.

- Clean the exterior of the system with the provided cleaning cloth or another soft, dry cloth.
- Do not use any sprays near the system.
- Do not use any solvents, chemicals or cleaning solutions containing alcohol, ammonia or abrasives.
- Do not allow objects to drop into any openings.

Customer service

For additional help using the system:

- Visit global.Bose.com/Support/AM300
- Contact Bose® customer service. Refer to the contact sheet in the carton.

Limited warranty information

Your system is covered by a limited warranty. Details of the limited warranty are provided on the warranty card in the carton. Please refer to the card for instructions on how to obtain warranty service and register your product. Failure to register will not affect your limited warranty rights.

The warranty information provided with this product does not apply in Australia and New Zealand. See our website at www.bose.com.au/warranty or www.bose.co.nz/warranty for details of the Australia and New Zealand warranty.

Technical information

Input power rating: 100-240V \sim 50/60 Hz, 180W

Service connectors

The SERVICE connector is for service use only. Do not insert any cables into this connector.

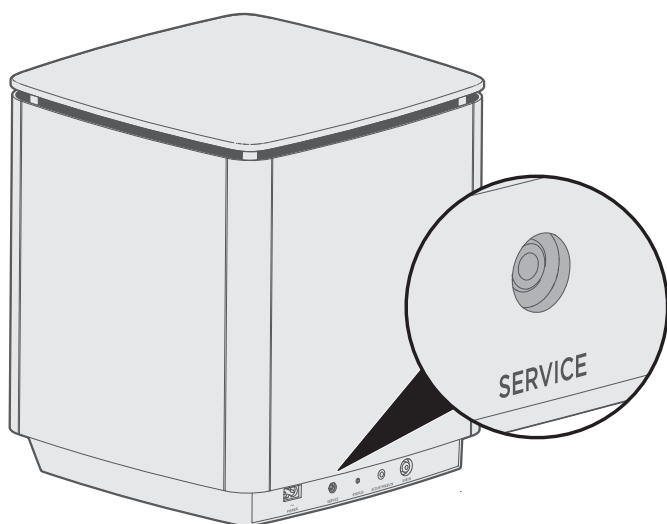

If you experience problems with your bass module:

- Unplug the power cords for the bass module and SoundTouch® 300 soundbar, wait 30 seconds and plug them firmly into a live AC (mains) outlet.
- Secure all cables.
- Check the state of the system status indicator (see page 16).
- Move the bass module and SoundTouch® 300 soundbar away from possible interference (wireless routers, cordless phones, televisions, microwaves, etc.).
- Move the SoundTouch® 300 soundbar within the recommended range of your wireless router or mobile device for proper operation.
- Place the bass module according to the placement guidelines (see page 8).

If you continue to experience problems, see “Common solutions” before contacting Bose® customer service. This table is designed to help you identify and correct many common problems that can occur with your Bose product.

Common solutions

The following table lists symptoms and possible solutions to common problems.

Symptom	Solution
No power	<ul style="list-style-type: none"> • Use the SoundTouch® 300 remote control to power on the soundbar (refer to the SoundTouch® 300 owner’s guide).
Bass module doesn’t pair with the soundbar	<ul style="list-style-type: none"> • Repeat the pairing process (see page 10). • Connect the bass module to the soundbar using a 3.5 mm stereo cable (see page 22). If you don’t have a 3.5 mm stereo cable (commonly used for headphones and mobile devices), contact Bose® customer service to receive this part. Refer to the contact sheet in the carton. You can also purchase this part at your local electronics store.

TROUBLESHOOTING

Symptom	Solution
Intermittent or no audio	<ul style="list-style-type: none">• Unmute the system.• Increase the volume.• Ensure that the soundbar's HDMI™ cable is inserted into a connector on your TV labeled ARC or Audio Return Channel. If your TV does not have an HDMI (ARC) connector, connect to the soundbar using the optical cable (refer to the SoundTouch® 300 owner's guide).• Insert the soundbar's optical cable into a connector on your TV labeled Output or OUT, not Input or IN.• Ensure that your TV can output audio from connected sources and that audio output is enabled (refer to your TV owner's guide).• Repeat the pairing process (see page 10).• If your source is connected to your TV:<ul style="list-style-type: none">– Select the correct TV input (refer to the SoundTouch® 300 owner's guide).– Plug your source directly to the soundbar and select the appropriate settings in the SoundTouch® app to play audio directly from the source (refer to the SoundTouch® 300 owner's guide).
Poor or distorted sound	<ul style="list-style-type: none">• Test different sources if available.• Remove all protective films from the bass module.• Run ADAPTiQ® audio calibration (see page 12).
Bass is too heavy or low	<ul style="list-style-type: none">• Adjust the bass setting of the system (see page 14).• Run ADAPTiQ audio calibration (see page 12).• Move the bass module away from nearby walls and corners.

Unable to complete ADAPTiQ® audio calibration

Listen to the voice prompts for the following error messages:

Error message	Problem	What to do
1	The microphone on the ADAPTiQ headset cannot detect sound.	<ul style="list-style-type: none"> Secure all cables. Disconnect the ADAPTiQ headset cable and reconnect it firmly into the soundbar's ADAPTiQ connector. Ensure the microphone opening on the top of ADAPTiQ headset is not blocked. Your ADAPTiQ headset may be damaged. Call Bose® customer service for replacement parts. Refer to the contact sheet in the carton.
2	The room is too loud.	Rerun ADAPTiQ audio calibration when the room is quiet.
3	The ADAPTiQ headset is too close to the speakers.	Move the ADAPTiQ headset farther away from the speakers.
4	The listening locations are too similar.	Move 1 – 2 ft. (.3 – .6 m) away from your previous listening location.
5	The ADAPTiQ headset cannot take measurements due to movement.	Hold your head still.

After correcting your problem, you must rerun ADAPTiQ audio calibration (see page 12).

If you hear a different error message, contact Bose customer service for further instructions. Refer to the contact sheet in the carton.

Unable to pair bass module with soundbar

If you are unable to pair the bass module with the soundbar, you can also connect the module to the soundbar using a 3.5 mm stereo cable (not provided).

Note: If you don't have a 3.5 mm stereo cable (commonly used for headphones and mobile devices), contact Bose® customer service to receive this part. Refer to the contact sheet in the carton. You can also purchase this part at your local electronics store.

1. Connect one end of a 3.5 mm stereo cable to the **ACOUSTIMASS IN** connector on the back of the bass module.

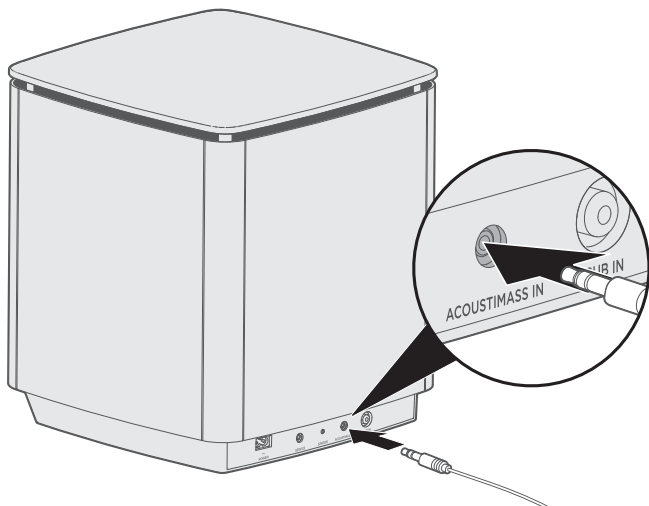

2. Connect the other end of the cable to the **ACOUSTIMASS** connector on the back of the SoundTouch® 300 soundbar.

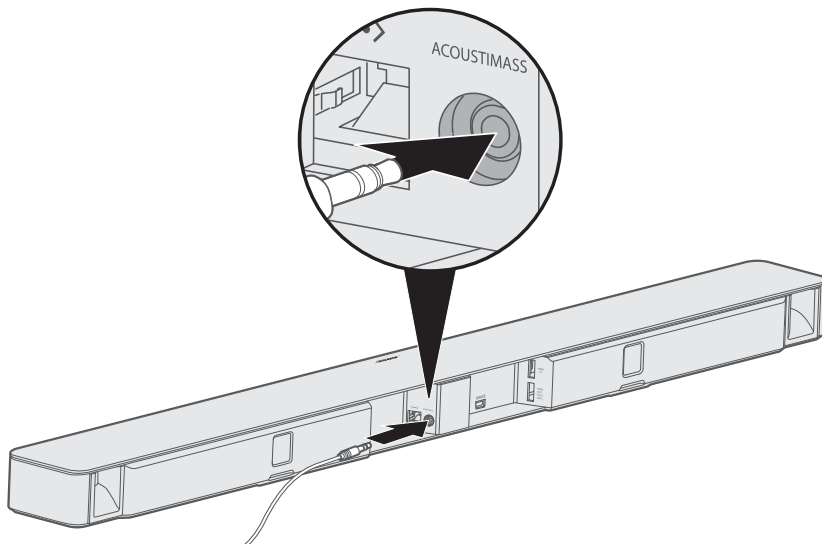

3. Check for sound (see page 11).



772090-0010

BOSE[®]
Better sound through research[®]

©2016 Bose Corporation, The Mountain,
Framingham, MA 01701-9168 USA
AM772090 Rev. 00