

10% OFF

Your next order at Havahart.com

Shop all Havahart® solutions and protect your home from all angles!

Coupon Code:

HHPROMO

Caught a critter in the act?

Visit us on Facebook to share your favorite photos of critters you've spotted, for the chance to win gift cards, free product and more!



Like us to enter:

www.facebook.com/HavahartBrand

Havahart® Spray Away® Animal Repellent Sprinkler Owner's Manual

Model #5266



www.Havahart.com

Version 11/18/14

*Thank you for purchasing the
Havahart® Spray Away® Animal Repellent!*

Content	Page
Cautions	3
Intro	4
Parts	5
Setup	6-8
Repelling An Animal	9
Sensitivity Guide	10
Troubleshooting	11
Warranty	12

- ⚠ Intended to operate with typical household water pressure—between 30 and 80 psi.
- ⚠ Malfunctioning sprinklers carry an inherent risk of causing water damage to your property. Mitigate your risk by limiting the amount of water available to the unit (open hose valve 3/4 turn maximum) and ensuring your water pressure is within the normal operating range for the unit.
- ⚠ Use a high quality garden hose with a solid brass connector for a leak-free, durable connection. Any visible wear (especially on hose thread), such as bends or dings, can cause the connection to leak.
- ⚠ When pushing the stake into the ground, use the step-in-stake. DO NOT push down or apply weight on the top of the unit body.
- ⚠ To prevent damage from freezing water, bring Spray Away inside when the temperature drops below 32°F.
- ⚠ To minimize false triggers, avoid pointing Spray Away at moving water, windy areas and moving vehicles.

**DO NOT PUSH DOWN
ON UNIT!**

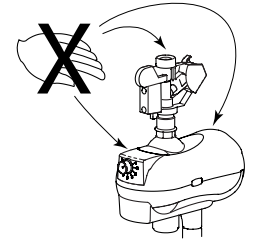

Intro

Havahart® Spray Away® Motion Activated Sprinkler Repellent provides an innovative, humane way to keep unwanted animals out of your yard and garden. Sensing animals of all sizes, Spray Away® provides an environmentally-friendly and safe alternative to chemical repellents and electric fences. Spray Away® uses an infrared sensor to detect the animal, and then deploys a burst of water combined with unexpected noise and motion to create a safe and effective deterrent.

Spray Away® features an **Adjustable Sensor Eye**, which adjusts to sense a variety of different animal sizes. Adjust the eye up to scare birds and large animals, and down for smaller animals. The eye is also useful to adjust to varying slope changes and different terrain. This feature gives you a wider range of coverage to protect your yard and garden from a variety of animals on different terrain and in many different locations.

Spray Away®'s **Step-In Stake** design makes it easy to stake the unit into the ground using a footstep.

Spray Away® is powerful enough to protect up to 1,900 square feet while detecting motion 35 feet in front of the unit. Whether you have a deer or rabbit snacking on plants, or a heron stealing fish from your pond, the versatile Spray Away® will condition these critters to find lunch elsewhere!

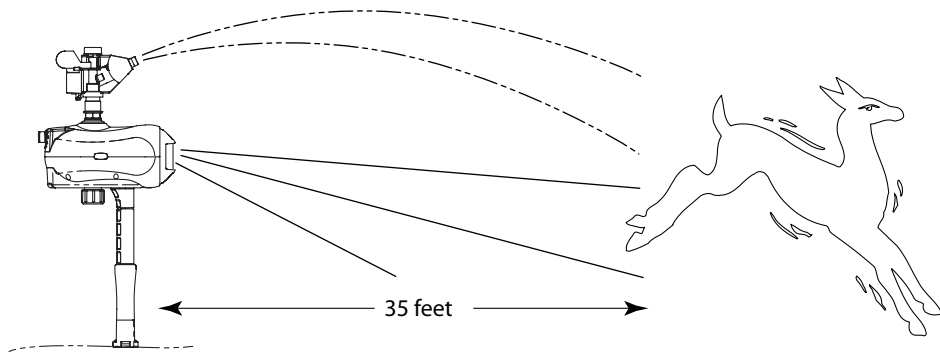

Parts

Missing something? Call us at 1.855.5.HAVAHART!

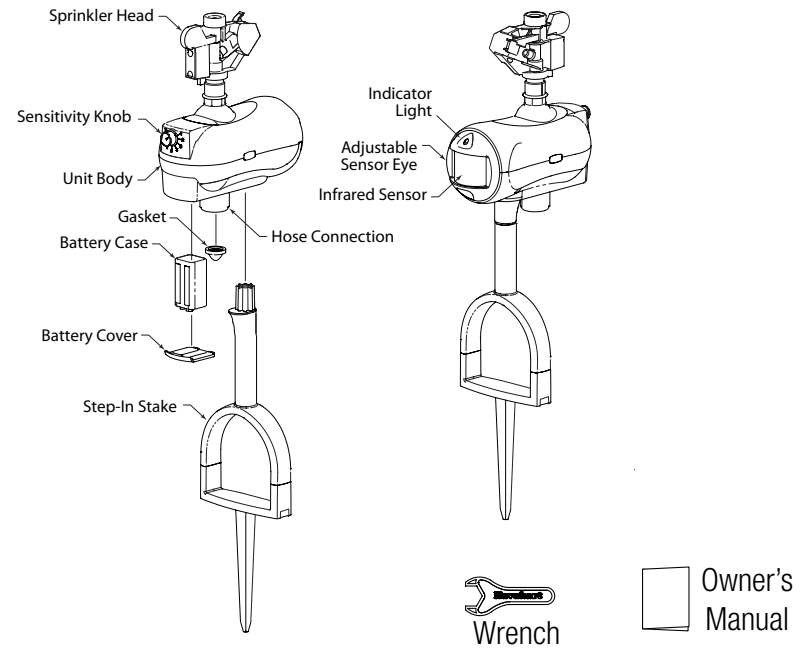

What you will need:

High Quality Garden Hose

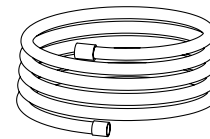

Access to Tap

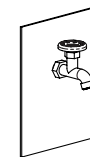

4 AA Batteries

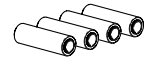

Setup

1. Attach Sprinkler Head

- Attach Sprinkler Head lightly by hand.
- Fully tighten Sprinkler Head with the provided Plastic Wrench. Wrench will slip off to prevent overtightening.

Note: Using tools other than the provided Wrench will damage the unit and result in leaking and/or unit malfunction.

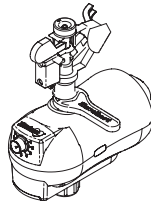

2. Install Batteries

- Battery case is located under Unit Body.
- Install 4 AA batteries into Unit Body.

4. Stake in Area You Want to Protect

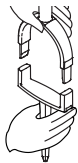

A

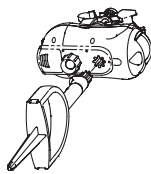

B

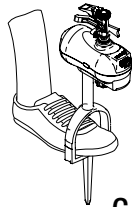

C

- Assemble the Step-in-Stake, and attach it to the Unit Body. (A and B)
- Place your foot into Step-in-Stake, and gently press the unit into the ground. (C)
- Ex: Place in/next to landscape you are trying to protect with sensor facing the direction animals are approaching.

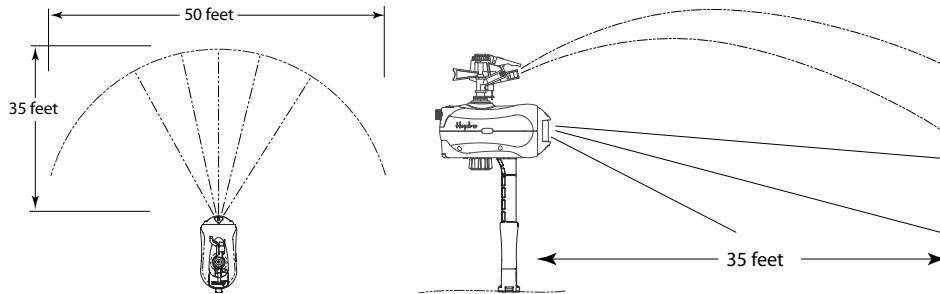

Setup Cont.

5. Adjust the Infrared Sensor (optional)

- Rotate the Infrared Sensor.
 - Up: if terrain inclines in front of unit, or for sensing taller animals.
 - Down: if terrain descends in front of unit, or for sensing smaller animals.
- DO NOT PUSH DIRECTLY ON LENS - use palm of hand on plastic to rotate.

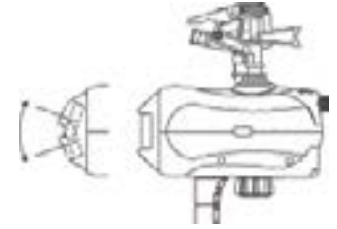

6. Adjust the Spray Width (spray width from left to right)

- Position Metal Clip between the stem tabs to achieve desired spray width (use images below as a guide).
- Be sure to position Metal Clip so it is facing the same direction as Infrared Sensor.

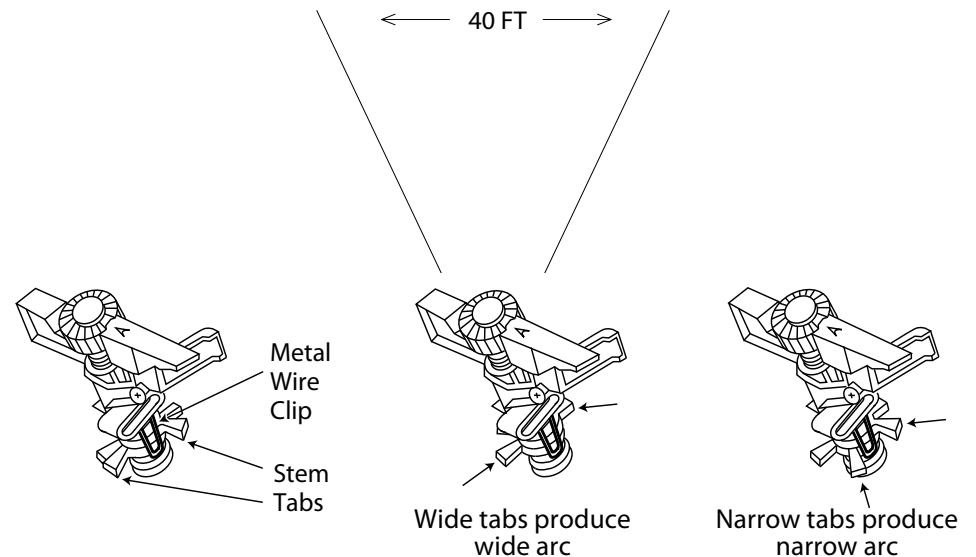

Setup Cont.

7. Adjust the Spray Distance (optional)

- Rotate dial on top of the Sprinkler Head to adjust Spray Distance. Use “MIN” and “MAX” as guidelines (MAX = 35 feet).

Note: Spray distance also varies depending on water pressure.

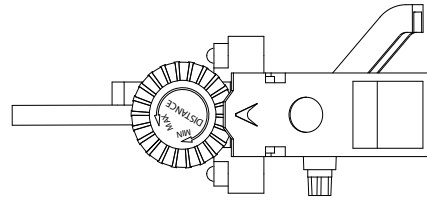

8. Attach a High Quality Garden Hose

- Use a high quality garden hose with a solid brass connector for a leak-free, durable connection.
- With your water OFF, attach a garden hose to the Unit Body.
- Ensure the Screen Gasket is secure inside the Unit Body.



Screen Gasket

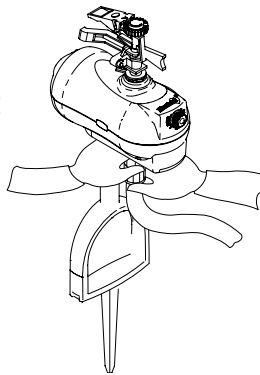

9. Test Spray Away

- Turn water ON and approach Spray Away from behind.
- Turn Sensitivity Knob on back of unit to level 5.
- Wait 15 seconds. Then wave your hand in front of the Infrared Sensor. Unit should activate.
- Adjust the spray width and distance as needed (Page 7).

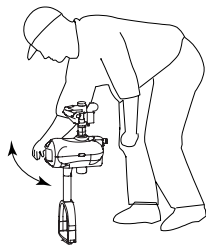

Repelling An Animal

Setting and Testing the Sensitivity

- Turn Sensitivity Knob to 3 (This gives you a starting point to adjust from.)
- With your water OFF, stand in front of the Spray Away at the furthest distance you want to detect. (Max. is 35 feet away from unit.)
- Wait 10 seconds (remain still as it calibrates). See Important Note below.
- Staying the same distance from the unit walk back and forth to test if the unit can see you. The Indicator Light will blink if it sees you.
- If Spray Away does not see you, select the next highest sensitivity level. (Higher number = higher sensitivity level.)
- Continue to select the next highest sensitivity level until the Spray Away sees you. Once it sees you, your desired coverage area has been set correctly.

IMPORTANT NOTE: *Spray Away does not sense for 10 seconds after an activation. This means when testing the coverage area you will need to wait (remain still) for 10 seconds before moving again.*

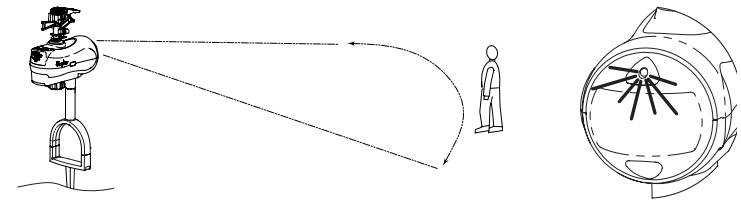

Use the Sensitivity Guide (Page 10) as a reference.

Sensitivity Guide

Occasionally sensitivity may need to be adjusted based on outside temperature.

When the weather is warmer, higher sensitivity levels are required. When the weather is cooler, lower sensitivity levels are required. Use charts as a guide.

Note: Depending on the animal your trying to deter and your surroundings it may take several adjustments to identify the best sensitivity setting.

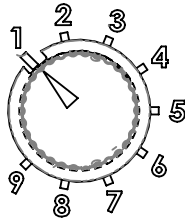

Below 80°F

		Desired Detection Distance		
		10 feet	20 feet	30 feet
Animal Size	Small	7	8	8
	Medium	5	6	7
	Large	2	2	3

Above 80°F

		Desired Detection Distance		
		10 feet	20 feet	30 feet
Animal Size	Small	9	9	9
	Medium	8	9	9
	Large	4	5	6

Animal Size Examples:

- Small - Birds, Rabbits, Squirrels
- Medium - Cats, Raccoons, Skunks, Groundhogs
- Large - Deer, Dogs, Foxes

Spray Away relies on sight to activate, therefore some small animals may be difficult to detect. This unit is not recommended for repelling mice, rats or other similiar sized pests.

Troubleshooting

Problem	Solutions	Diagram
Spray Away does not "see" animals	<ul style="list-style-type: none"> • Increase the Sensitivity (page 9 and 10). • Clean the Infrared Sensor with a damp cloth. • Change batteries and repeat setup process 	
Spray Away is not spraying, or is only lightly spraying	<ul style="list-style-type: none"> • If the Indicator Light is blinking continuously every 3 seconds, change the Batteries. • Ensure the Hose and Sprinkler Head are tightly secured. 	
Spray Away is activating when no animal is present	<ul style="list-style-type: none"> • Reduce the Sensitivity (page 9 and 10). 	
Spray Away will not stop spraying	<ul style="list-style-type: none"> • Ensure Screen Gasket is secure in Unit Body, at the hose connection. If it is not, it is likely that debris from your hose has made its way up into the Unit Body, causing it to malfunction. • Your water pressure could be too high - it should not exceed 80 psi. 	
Unit is leaking at hose connection	<ul style="list-style-type: none"> • Make sure the Hose is tightly secured. • Ensure that the Hose thread is not damaged (free of bends or dings). • Check to be sure that the hose connection is free from debris. • Ensure water pressure is not too high - it should not exceed 80 psi. 	

Warranty

This warranty, two (2) years from the purchase of the unit, is extended only to the original purchaser/user of products.

Woodstream Corp. warrants its products to be free from defects in materials and workmanship for the warranty period by the original purchaser/user.

For warranty service, please contact our Customer Service at (855) 5-HAVAHART. Please indicate the nature of the defect.

If Woodstream Corp. determines there may be a defect, Woodstream Corp. will issue a Return Goods Authorization (RGA) number. The defective unit or parts must be returned for warranty inspection using the RGA number, when applicable, as identification within (30) days of return authorization date. DO NOT return products to our factory without our prior consent, as they, as well as C.O.D. shipments will be refused. Woodstream Corp., at its option, shall replace the unit, or replace the defective part(s) and return such unit to you. Woodstream Corp.'s sole obligation and your exclusive remedy under this warranty shall be limited to such replacement.

Limitations and Exclusions: The warranty shall not apply to problems arising from normal wear , or failure to adhere to the enclosed instructions. In addition, the foregoing warranty shall not apply to serial numbered products if the serial number has been removed or defaced; products subject to negligence, accident, improper operation, maintenance or storage; products damaged by circumstances beyond Woodstream Corp.'s control; or products modified (including, but not limited to modifications through the use of unauthorized parts or attachments) or repaired by anyone other than Woodstream Corp. or its designee.

The foregoing warranty is exclusive and in lieu of all other warranties, express or implied, including without limitation the implied warranties of merchantability and fitness for a particular purpose. It shall not extend beyond the duration of the express warranty provided herein, and the remedy for violations of any warranty shall be limited to repair or replacement of the defective product pursuant to the terms contained herein. Woodstream Corp. shall not be liable for any consequential or incidental damages whatsoever.

This warranty gives you specific legal rights and you may also have other legal rights which may vary based on location.

Visit us at:
www.Havahart.com