

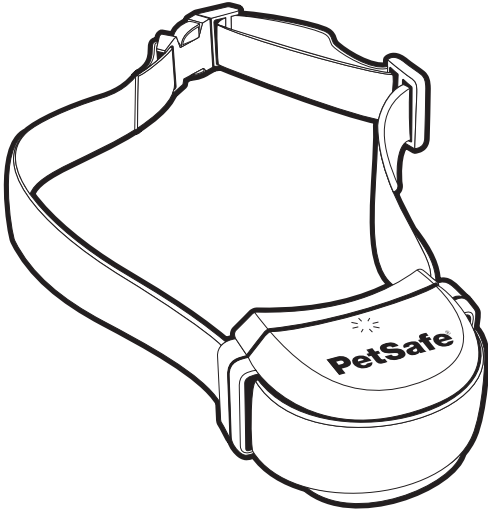

protect. **teach.** love.®



Model Number
PIF00-12917



stay + play wireless fence®
operating and training guide

PLEASE READ THIS ENTIRE GUIDE BEFORE BEGINNING

Important Safety Information

Explanation of Attention Words and Symbols used in this guide



This is the safety alert symbol. It is used to alert you to potential personal injury hazards. Obey all safety messages that follow this symbol to avoid possible injury or death.

⚠ WARNING

WARNING indicates a hazardous situation which, if not avoided, could result in death or serious injury.

CAUTION

CAUTION, used without the safety alert symbol, indicates a hazardous situation which, if not avoided, could result in harm to your pet.

NOTICE

NOTICE is used to address safe use practices not related to personal injury.

⚠ WARNING

- Not for use with aggressive dogs. Do not use this product if your dog is prone to aggressive behavior. Aggressive dogs can cause severe injury or death to their owners and others. If you are not sure that this product is right for your dog, please talk to your veterinarian or a certified trainer.
- Risk of electric shock. Use the Fence Transmitter indoors in dry location only.

CAUTION

- This PetSafe® Stay + Play Wireless Fence® is NOT a solid barrier. The system is designed to act as a deterrent to remind pets by Static Correction to remain in the boundary established. It is important that you reinforce training with your pet on a regular basis. Since the tolerance level to Static Correction varies from pet to pet, Radio Systems® Corporation CANNOT guarantee that the system will, in all cases, keep a pet within the established boundary. Not all pets can be trained to avoid crossing the boundary! Therefore, if you have reason to believe that your pet may pose a danger to others or harm himself if he is not kept from crossing the boundaries, you should NOT rely solely upon the PetSafe® Stay + Play Wireless Fence® to confine your pet. Radio Systems® Corporation shall NOT be liable for any property damage, economic loss or any consequential damages, sustained as a result of any animal crossing the boundary.
- Proper fit of the collar is important. A collar worn for too long or made too tight on the pet's neck may cause skin damage. Ranging from redness to pressure ulcers; this condition is commonly known as bed sores.
 - Avoid leaving the collar on the dog for more than 12 hours per day.
 - When possible reposition the collar on the pet's neck every 1 to 2 hours.
 - Check the fit to prevent excessive pressure; follow the instructions in this manual.
 - Never connect a lead to the electronic collar; it will cause excessive pressure on the contacts.
 - When using a separate collar for a lead, don't put pressure on the electronic collar.
 - Wash the dog's neck area and the contacts of the collar weekly with a damp cloth.
 - Examine the contact area daily for signs of a rash or a sore.
 - If a rash or sore is found, discontinue use of the collar until the skin has healed.
 - If the condition persists beyond 48 hours, see your veterinarian.
 - For additional information on bed sores and pressure necrosis, please visit our website.

CAUTION

These steps will help keep your pet safe and comfortable. Millions of pets are comfortable while they wear stainless steel contacts. Some pets are sensitive to contact pressure. You may find after some time that your pet is very tolerant of the collar. If so, you may relax some of these precautions. It is important to continue daily checks of the contact area. If redness or sores are found, discontinue use until the skin has fully healed.

- You may need to trim the hair in the area of the Contact Points. Never shave the dog's neck; this may lead to a rash or infection.
- Always remove your dog's Receiver Collar before performing any Transmitter testing.
- The Receiver Collar should not be on your dog when the system is tested. Your pet may receive an unintended correction.
- The Boundary Width of the system must be tested whenever an adjustment is made to the containment field to prevent unintended corrections to your pet.
- If you use a collar and leash for training, be sure the extra collar does not put pressure on the contact points.
- Never remove power from the system when the collar is on the pet. This may activate the Receiver Collar.
- Radio Systems® Corporation recommends the use of an Uninterruptible Power Supply (UPS) for use with your wireless fence. Should the power go out at your home, your pet will be unprotected. Power outages can be unpredictable, and the use of a UPS will provide you with some time to properly restrain your pet.

In rare instances, if your pet is near the boundary at the time when the power fails, it is possible that your pet will receive a correction. This correction will stop after a 15 second timeout period has been reached. This is due to the operation of the collar: the collar is activated by the absence of the containment signal.

While results will vary depending on the UPS manufacturer's specifications the following are typical examples to guide your choice of UPS:

- Using a 400 VA UPS a consumer should expect 1 hour of backup time.
- Using a 900 VA UPS a consumer could expect 4 hours of backup time.

If settings below maximum fence size are used, additional backup time will result. At minimum fence size settings backup time may be more than two times the backup time estimated at maximum fence size.

NOTICE

- To prevent an unintended correction, after the Boundary Flags have been placed, be sure to set the static correction on the Receiver Collar back to level 1 tone only.
- Do not charge your Receiver Collar every night. Charging too often can reduce battery life. Charge your Receiver Collar when the Receiver Indicator Light blinks yellow; or when the light blinks red.
- Do not place anything on the top of the Transmitter or cover any ventilation holes. This may overheat the Transmitter and cause early transmit failure.
- Do not place Transmitter in a closet or any other confined, unventilated area.
- Do not place Transmitter on a metal surface.

Thank you for choosing PetSafe® brand. You and your pet deserve a companionship that includes memorable moments and a shared understanding together. Our products and training tools promote a lifestyle of protection, teaching, and love — essentials that influence memories for a lifetime. If you have any questions about our products or training your pet, please visit our website at www.petsafe.net or contact our Customer Care Center at 1-800-732-2677.

To get the most protection out of your warranty, please register your product within 30 days at www.petsafe.net. By registering and keeping your receipt, you will enjoy the product's full warranty and should you ever need to call the Customer Care Center, we will be able to help you faster. Most importantly, PetSafe® will never give or sell your valuable information to anyone. Complete warranty information is available online at www.petsafe.net.

Table of Contents

Components.....	5
Other Items You May Need	5
How the System Works	6
Key Definitions	6
Operating Guide	7
Set Up the Transmitter	7
Charge the Receiver Collar	8
Prepare the Receiver Collar.....	8
Adjust the Pet Area to Desired Size.....	11
Transmitter Range Chart.....	12
Place the Boundary Flags	12
Fit the Receiver Collar	13
Training Guide	15
Be Patient With Your Pet	15
Day 1 - Boundary Awareness.....	16
Days 2 thru 4 - Continue Boundary Awareness.....	17
Days 5 thru 8 - Distraction Phase	17
Days 9 thru 14 - Unleashed Supervision.....	18
Days 15 thru 30 - Pet Monitoring.....	19
Taking Your Pet Out of the Pet Area.....	19
Wireless-To-Go	20
Accessories.....	20
Frequently Asked Questions	21
Troubleshooting	23
Terms of Use and Limitation of Liability	26
Compliance	27
Customer Care International.....	27
Mounting Template	28

Components

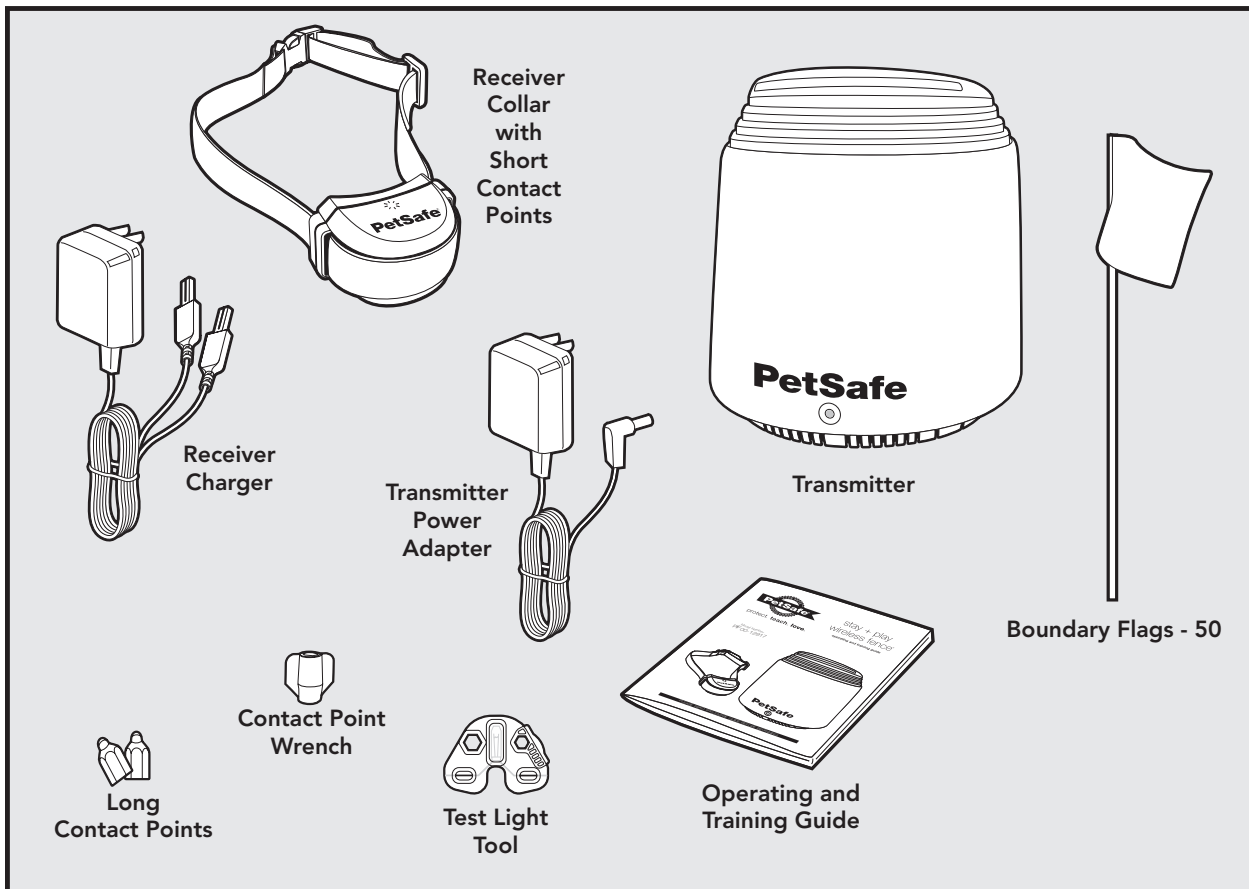

Other Items You May Need

- Screwdriver
- Scissors
- Lighter
- Drill & mounting hardware
- Tape measure
- Non-metallic collar and leash

Set up and training help: www.petsafe.net/fence

How the System Works

The PetSafe® Stay + Play Wireless Fence® has been proven safe, comfortable, and effective for pets over 5 pounds. The system works by transmitting a radio signal up to 105 feet in all directions. You temporarily define the Pet Area with Boundary Flags for a visual aid in training your pet. Your pet wears a Receiver Collar with Contact Points that touch his neck, and, once trained, is allowed to roam freely in the Pet Area. When your pet reaches the Boundary Zone, the Receiver Collar gives a warning tone before delivering a safe Static Correction through the Contact Points to get his attention until he returns to the Pet Area.

Key Definitions

Transmitter: Transmits the radio signal and is the center of the Pet Area.

Pet Area: Distance from the Transmitter where your pet can roam freely.

Boundary Zone: 2 to 3 foot wide area outside the Pet Area where your pet's Receiver Collar will begin to tone and then begin to deliver a Static Correction. The correction will start in the Boundary Zone and continue anywhere beyond the Pet Area. *Note: The Receiver Collar is equipped with a safety time-out feature that will stop correcting after 15 seconds if your pet remains outside the Pet Area.*

Receiver Collar: Receives the radio signal from the Transmitter.

Receiver Indicator Light: Indicates the level of correction at which the Receiver Collar is set. This light also indicates battery status.

Contact Points: Deliver the safe Static Correction when your pet moves into the Boundary Zone.

Mode Button: Turns Receiver on/off and adjusts the level of Static Correction your pet receives outside the Pet Area.

Receiver Charger: Charges the batteries inside the Receiver Collar

Receiver Charge Jack: Connection point for charging Receiver battery.

Power Light: Indicates when the Transmitter is on.

Power Jack: Where the Power Adapter plugs into the Transmitter. The Transmitter is powered by a standard 120-volt outlet.

Boundary Switch: Adjust according to the size of the Pet Area desired. *Note: Adjusting the switch does not change the level of Static Correction on the Receiver Collar.*

Boundary Control Dial: Adjusts the distance from the Transmitter to the Boundary Zone. *Note: Adjusting the dial does not change the level of Static Correction on the Receiver Collar.*

Alarm Disable Button: Silences Transmitter Alarm

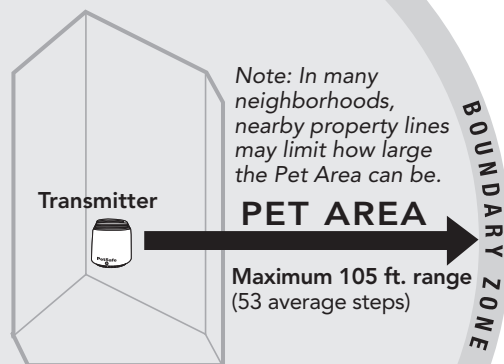

Receiver Collar

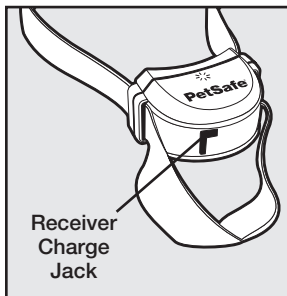
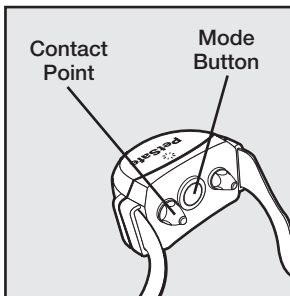
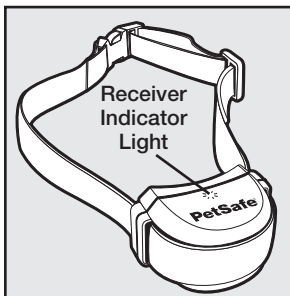

Transmitter

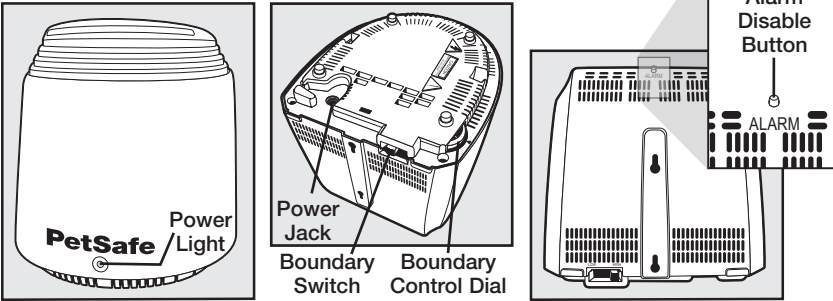

Operating Guide

Step

1 Set Up the Transmitter

Important: You may need to move the Transmitter several times before determining the final location.

The Transmitter is located at the exact center of the Pet Area. Place the Transmitter:

- At least 2 feet above the floor located on the ground floor of your home.
- In a dry, well ventilated, protected area.
- In an area where temperatures do not fall below -10° F.
- On a non-metal table or other hard surface to ensure proper ventilation (1A).

NOTICE

- Do not place anything on top of Transmitter or cover any ventilation holes. This may overheat the Transmitter and cause early transmit failure.
 - Do not place Transmitter in a closet or any other confined, unventilated area.
 - Do not place Transmitter on a metal surface.
- At least 3 feet from large metal objects, as these items may reduce the size and shape of your Pet Area (1B). Placing the Transmitter inside a metal building or shed can reduce the maximum range of the Stay + Play Wireless Fence®.

You can mount on a wall (1A). A mounting template is included on the back of this guide.

The Transmitter has two built in warning alarms: a Power Loss Alarm and a Transmission Failure Alarm.

The Transmitter Power Loss Alarm sounds an intermittent tone alarm indicating power has been removed from the Transmitter. The Power Loss Alarm will last up to 30 minutes. In the event of a power loss, your pet is no longer contained.

There are 3 ways to turn off the Power Loss Alarm.

1. Plug adapter into a functional 120-volt outlet.
2. Unplug Transmitter power Adapter from the Power Jack located on the bottom of the Transmitter.
3. Press the Alarm Disable button for 5 seconds then release. Three short tones will sound to signify the alarm has been turned off.

The Transmission Failure Alarm makes a continuous tone indicating a Transmitter problem. In this situation, your pet can no longer be contained. Contact the Customer Care Center for a replacement at 1-800-732-2677.

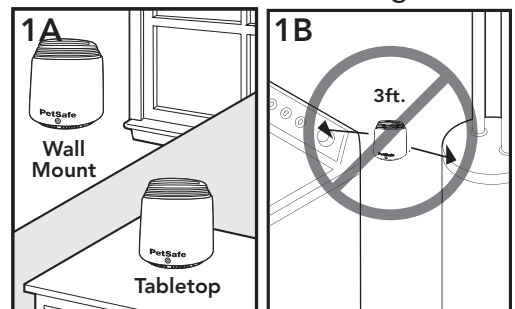

2 Charge the Receiver Collar

The Receiver Collar Charger is designed to plug into a standard AC wall outlet. The Receiver Collar light will glow red when the Receiver Charger is properly seated into the Receiver Charge Jack. The light will turn green when charging is complete. A built in safety circuit prevents the Receiver Collar from overcharging.

The Receiver Collar will achieve a full charge in 2-3 hours. Each charge can last up to 3 weeks depending upon frequency of use.

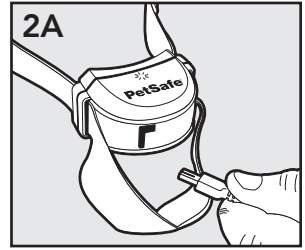

NOTICE

- Do not charge your Receiver Collar every night. Frequent charging can have a negative effect on the battery. We recommend that the Receiver Collar be used until the Receiver Indicator Light blinks yellow or red.

To charge the Receiver Collar, lift and slide the Receiver Collar strap away from the front of the unit (2A). Lift the rubber plug to allow access to the Receiver Charge Jack. The rubber plug needs to remain attached to the Receiver Collar. Plug the Receiver Charger into the Receiver Charge Jack on the Receiver Collar. The Receiver Charge Jack and Receiver Charger are keyed to fit one way. Do not force it in backwards.

3 Prepare the Receiver Collar

Your Receiver Collar comes with Short Contact Points. Use the Long Contact Points for pets with long or thick hair. Tighten the Contact Points using the Contact Point Wrench (3A). Check tightness weekly.

Turning the Receiver Collar ON

Press and hold the Mode Button continuously for 5 seconds (3B). The green or yellow or red Receiver Indicator Light will turn ON for 5 seconds (3C) to indicate battery status, followed by the red Receiver Indicator Light flashing the Static Correction Level Settings.

Turning the Receiver Collar OFF

Press and hold the Mode Button continuously for 5 seconds. The red Receiver Indicator Light will be ON during this time. The red Receiver Indicator Light will then turn OFF and all Receiver Indicator Lights will stay OFF indicating that the unit is turned OFF.

To extend the time between charging the Receiver Collar, consider turning OFF the Receiver Collar when it is not in use.

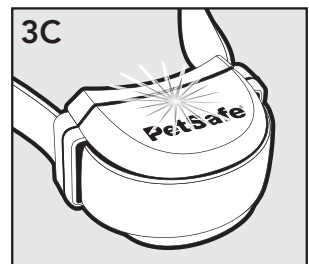
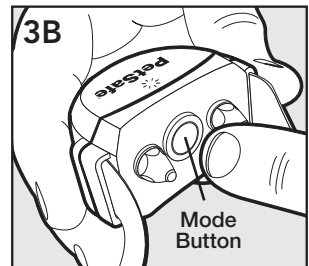
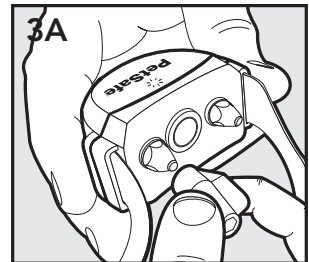

Receiver Collar Status Indicators

The Receiver Collar Status Indicator Light along with the Receiver Collar Alarm Tone are used to determine the battery status, and the correction type. Refer to the Receiver Collar Status Indicator Table below to understand the status lights and tones for the Receiver Collar.

During normal operation, the Receiver Collar Indicator Light will flash every 4-5 seconds to indicate the battery status as shown in the table below.

Receiver Collar Status Indicator Table		
Status Light	Alarm Tone	Condition
While Plugged into Receiver Charger		
Solid red	No tone	Charge in progress
Solid green	No tone	Charge complete
No light		Charge failure, contact Customer Care Center
After Removing from Receiver Charger		
Continuous green or yellow or red (5 seconds duration)	No tone	Battery Charge Indication. Occurs immediately after unplugging the charger from the Receiver Collar
Operating Battery Status		
Slow blinking green (every 4-5 seconds)	No tone	Collar battery charge 100%-60%
Slow blinking yellow (every 4-5 seconds)	No tone	Collar battery charge 60%-20%
Slow blinking red (every 4-5 seconds)	No tone	Collar battery charge 20% or less, charge immediately
Receiver Activation Status		
Fast pulsating green (3 flashes per second)	Warning tone	Warning tone
Fast pulsating red (3 flashes per second)	Tone for duration of Static Correction	Static Correction being delivered up to 15 seconds
Continuous green (10 seconds)	No tone	Over Correction Protection; collar locked for 10 seconds

To Set the Static Correction Level

Read all steps before attempting to set the Static Correction Level.

1. Press the Mode Button and release (**3B**) when the Receiver Indicator Light illuminates Red (**3C**).
2. The Receiver Indicator Light will emit a series of Red flashes representing the Static Correction Level.
3. Increase the Static Correction Level by pressing and releasing the Mode Button within 5 seconds of the previous series of flashes.

The Static Correction levels increase in strength from 1 to 6. Pushing the Correction Level Button while the Receiver Collar is on level 6 will cause the Receiver Collar to revert to level 1. Refer to the Function and Response Table to choose the Static Correction level that best fits your pet.

Function and Response Table			
Indicator Light Response	Static Correction Level	Receiver Collar Function	Temperament of Pet
1 Red Flash	1	No Static Correction, Tone Only	Initial Training Mode
2 Red Flashes	2	Low Static Correction	Timid
3 Red Flashes	3	Medium-Low Static Correction	Timid or Average
4 Red Flashes	4	Medium Static Correction	Average Energy
5 Red Flashes	5	Medium-High Static Correction	Average or High Energy
6 Red Flashes	6	High Static Correction	High Energy

Over Correction Protection

If your pet enters the Boundary Zone or continues anywhere beyond the Pet Area, this feature limits the Static Correction duration to 15 seconds. While the system locks out further Static Correction, the green light will remain on for 10 seconds.

In the unlikely event that your pet leaves the Pet Area, he will not receive a Static Correction upon return to the Pet Area.

4 Adjust the Pet Area to Desired Size

Make sure the entire Pet Area lies within your property boundaries (4A). Always start determining the Boundary Zone at the shortest distance from Transmitter. Place the Boundary Switch on "Low" if the Boundary Zone will be less than 45 feet from the Transmitter.

Test Light Instructions

1. Make sure the Receiver Collar Battery is properly charged. Set the Correction Level to 2 or above.
2. Hold the Test Light Contacts to the Contact Points. (4B)
3. Walk toward the Boundary Zone holding the Receiver Collar at your pet's neck level (4E) until the Test Light flashes (4F).

Save Test Light for future testing.

Note: If your next-door neighbor has an In-Ground Containment System, see Troubleshooting section page 24.

To maximize your Pet Area, make sure the Boundary Switch is on "High" and the Boundary Control Dial is set to "8" (4C & 4D). Plug Power Adapter into Power Jack and standard 120-volt outlet.

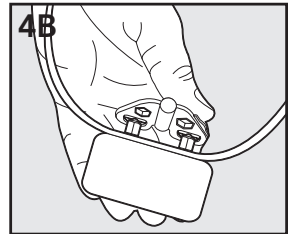
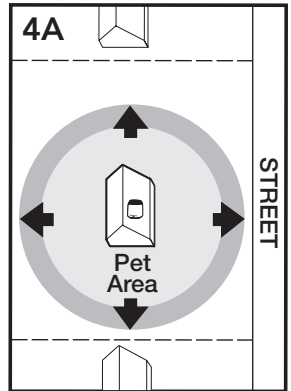

Two-Person Method

Hold the Receiver Collar at your pet's neck height (4E) with logo side facing away from the Transmitter and Contact Points facing upwards. Walk to the edge of the desired Pet Area. Facing away from the Transmitter, hold the Receiver Collar at the edge of the desired Pet Area (4F).

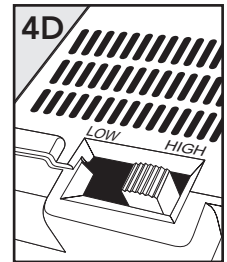
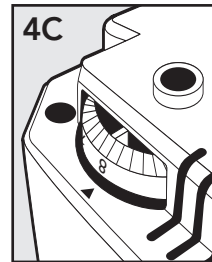

Starting with the Boundary Control Dial set to "8", have a second person turn the dial down SLOWLY. When the Receiver Collar starts to beep, tell the person to stop turning the Boundary Control Dial. Record your settings on the next page for future reference.

One-Person Method

Measure the shortest distance from the desired Boundary Zone to the Transmitter. Find the distance on the Transmitter Range Chart on the next page and set the Boundary Switch and Boundary Control Dial. Hold the Test Light Contacts to the Contact Points (4B). Take the Receiver Collar to the Boundary Zone with the logo side facing away from the Transmitter and Contact Points facing upwards (4E). Hold the Receiver Collar at your pet's neck level (4F) until the Receiver Collar beeps and the Test Light flashes. If the Receiver Collar beeps before or after the desired Boundary Zone, return to the Transmitter and adjust the Boundary Control Dial. Repeat this process until the Receiver Collar is beeping at the desired location. Record your settings on the next page for future reference.

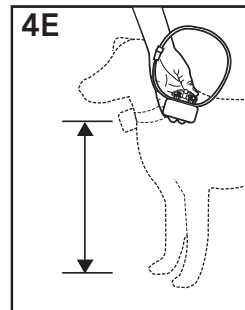

Transmitter Range Chart

Boundary Control Dial Position	Boundary Switch LOW	Boundary Switch HIGH
1	22 ft.	46 ft.
2	24 ft.	50 ft.
3	26 ft.	56 ft.
4	29 ft.	62 ft.
5	31 ft.	69 ft.
6	37 ft.	85 ft.
7	45 ft.	95 ft.
8	50 ft.	105 ft.

Note: These distances are approximate.

Record Your Settings

	Final Boundary Switch Setting (HIGH or LOW)	Final Boundary Control Dial Position (1-8)	Receiver Static Correction Level (1-6)
Home			
Camping			
Vacation			
Other			

Step 5

Place the Boundary Flags

The Boundary Flags are visual reminders for your pet of where the Boundary Zone is located. The Receiver Collar will activate within 2 to 3 feet of the Boundary Flags.

- Using the Test Light, with the Static Correction Level set at 2 or greater, hold the Receiver Collar at your pet's neck height with logo side facing away from the Transmitter.
- Walk towards the Boundary Zone until the Receiver Collar beeps and the Test Light flashes (5A).
- Place a Boundary Flag in the ground (5B).
- Walk back into the Pet Area until the beeping stops.
- Repeat this process around the Boundary Zone until it is marked with Boundary Flags every 10 feet.

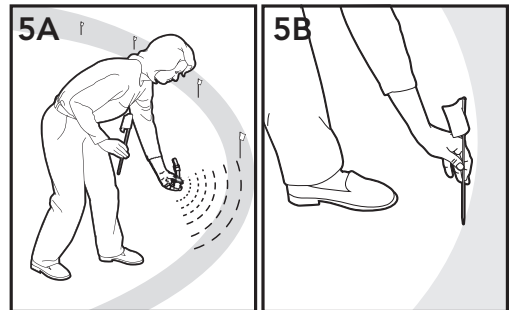

The Boundary Flags may be in different parts of the Boundary Zone and may not be in a line. The Boundary Zone is 2 to 3 feet wide.

6 Fit the Receiver Collar

Important: The proper fit and placement of your Receiver Collar is important for effective training. The Contact Points must have direct contact with your pet's skin on the underside of his neck.

CAUTION

Please read and follow the instructions in this manual. Proper fit of the collar is important. A collar worn for too long or made too tight on the pet's neck may cause skin damage. Ranging from redness to pressure ulcers; this condition is commonly known as bed sores.

- Avoid leaving the collar on the dog for more than 12 hours per day.
- When possible reposition the collar on the pet's neck every 1 to 2 hours.
- Check the fit to prevent excessive pressure; follow the instructions in this manual.
- Never connect a lead to the electronic collar; it will cause excessive pressure on the contacts.
- When using a separate collar for a lead, don't put pressure on the electronic collar.
- Wash the dog's neck area and the contacts of the collar weekly with a damp cloth.
- Examine the contact area daily for signs of a rash or a sore.
- If a rash or sore is found, discontinue use of the collar until the skin has healed.
- If the condition persists beyond 48 hours, see your veterinarian.
- For additional information on bed sores and pressure necrosis, please visit our website.

These steps will help keep your pet safe and comfortable. Millions of pets are comfortable while they wear stainless steel contacts. Some pets are sensitive to contact pressure. You may find after some time that your pet is very tolerant of the collar. If so, you may relax some of these precautions. It is important to continue daily checks of the contact area. If redness or sores are found, discontinue use until the skin has fully healed.

You may need to trim the hair in the area of the Contact Points. Never shave the dog's neck; this may lead to a rash or infection.

To assure a proper fit, please follow these steps:

1. Make sure Transmitter is not plugged in, and the receiver is turned off.
2. Start with your pet standing comfortably (**6A**).
3. To make it easier to hear the warning beep, place the Receiver Collar on your pet with the logo side of Receiver facing your pet's chin.
4. Center the Contact Points underneath your pet's neck, touching the skin.

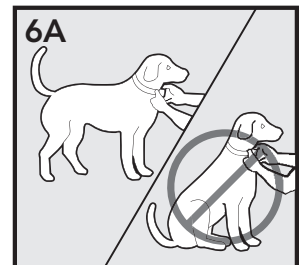

CAUTION

You may need to trim the hair in the area of the Contact Points. Never shave the dog's neck; this may lead to a rash or infection.

5. Check the tightness of the Receiver Collar by inserting one finger between the end of a Contact Point and your pet's neck. The fit should be snug but not constricting (**6B**).
6. Allow your pet to wear the collar for several minutes then recheck the fit. Check the fit again as your pet becomes more comfortable with the Receiver Collar.
7. Trim the collar as follows (**6C**):
 - a. Mark the desired length of the Receiver Collar with a pen. Allow for growth if your pet is young or grows a thick winter coat.
 - b. Remove the Receiver Collar from your pet and cut off the excess.
 - c. Before placing the Receiver Collar back onto your pet, seal the edge of the cut collar by applying a flame along the frayed edge.

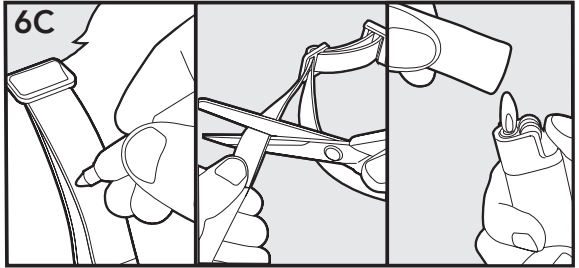

To Re-Thread the Collar

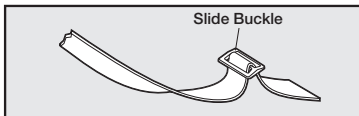

The slide buckle prevents the collar from becoming loose around your pet's neck.

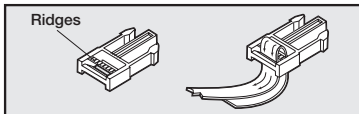

The ridges must be facing up; the collar will slip if it is not properly threaded.

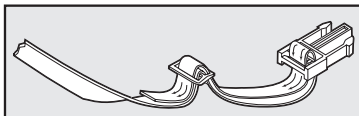

Training Guide

Be Patient With Your Pet

Important: Proper training of your pet is essential to the success of the PetSafe® Stay + Play Wireless Fence®. Read this section completely before beginning to train your pet. Remember that the PetSafe® Stay + Play Wireless Fence® is not a solid barrier.

- Have fun with your pet throughout the training process. Training should be fun, fair, firm and consistent.
- Train for 10 to 15 minutes at a time. Don't try to do too much too quickly. More-frequent short sessions are better than less-frequent longer sessions.
- We suggest a minimum of 14 days of training. Depending on your pet and how he learns, the training could take more or less time.
- If your pet shows signs of stress, slow down the training schedule, add additional days of training, or increase the amount of play time with your pet in the Pet Area. Common stress signals include:
 - Pet pulling on leash toward the house
 - Ears tucked
 - Tail down
 - Body lowered
 - Nervous / frantic movement or stiffening of pet's body
- Your pet must be completely comfortable near the Boundary Flags at the end of every training session. Spend at least 5 minutes of "play time" at the completion of each session within 10 feet of the Boundary Flags.
- Finish each training session on a positive note with lots of praise and play.
- Remove the Receiver Collar after each training session.
- Be sure to contain your pet by another means during the training period (e.g. pen, tie-out, leash, etc.).
- During training, if you need to take your pet out of the Pet Area, remove the Receiver Collar and either pick your pet up or put him in the car to pass out of the Pet Area.
- Even if you think your pet is responding well to the training, complete the entire training. Reinforcement is important!

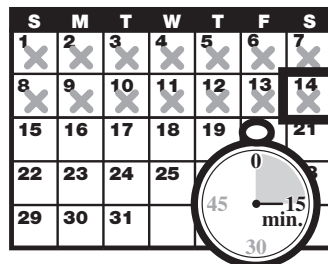

Day 1 - Boundary Awareness

Tone Only Training Mode

Perform three sessions on day 1, each training session lasting 10-15 minutes.

Goal:

To have your pet learn that the Boundary Flags and warning beep from the Receiver Collar define the new Pet Area.

Setup:

- Program the Static Correction Level on the Receiver Collar to Level 1 Tone Only training mode.
- Put a separate non-metallic collar on your pet's neck ABOVE the Receiver Collar and attach a leash.

CAUTION

Be sure the extra collar does not put pressure on the Contact Points.

- Have tiny pieces of treats that your pet will find desirable available (hot dogs or lunch meat work well).
- Have your pet's favorite play toy available.

Steps:

1. Begin by walking your pet on a leash in the Pet Area. Calmly praise and talk to your pet.
2. Move toward the Boundary Flags (1A). Keep your mood happy.
3. With full control of your pet on a leash, walk to the flags. As your pet enters the Boundary Zone, the Receiver Collar will begin to beep (1B). Allow your pet to stay in the Boundary Zone for up to 2 seconds then gently help him back into the Pet Area (1C). Immediately praise and offer your pet a treat as he enters the Pet Area, even if you have helped with the leash.
4. Repeat this process at the same Boundary Flag until your pet resists going into the Boundary Zone.
5. Aim to master 3-4 Boundary Flags per session. Make this FUN! Praise if your pet quickly retreats or resists going into the Boundary Zone.

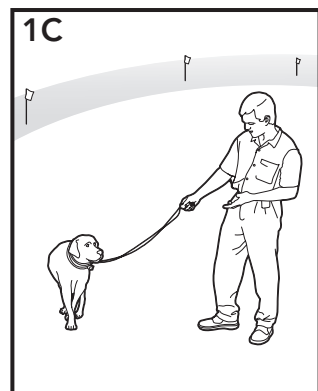
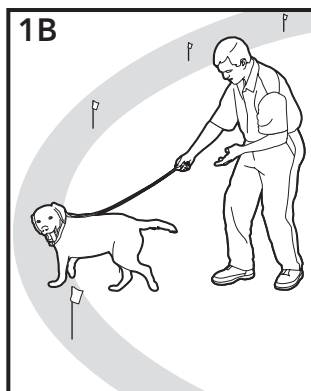
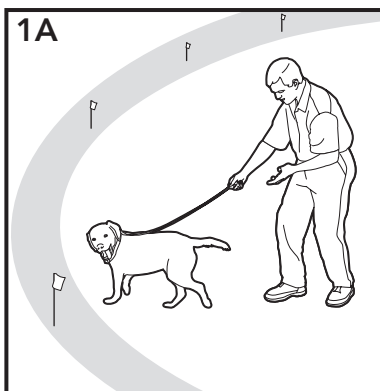

Phase
2

Days 2 thru 4 - Continue Boundary Awareness

Introduction to Static Correction

Perform three sessions per day, each lasting 10-15 minutes.

Goal:

To train your pet to stay in the Pet Area and respect the boundary.

Setup:

- Program the Static Correction Level on the Receiver Collar to Level 2.
- Put a separate non-metallic collar on your pet's neck ABOVE the Receiver Collar and attach a leash.

CAUTION

Be sure the extra collar does not put pressure on the Contact Points.

- Have tiny pieces of treats available (hot dogs or lunch meat work well).
- Have your pet's favorite play toy available.

Steps:

1. Repeat steps 1-5 in Phase One.
2. If your pet does not respond to the Static Correction, confirm that the Receiver Collar is fitting properly according to Step 6 on page 13.
3. If the Receiver Collar is fitted properly and your pet does not respond to the Static Correction, increase the Static Correction Level by 1. Watch for slight reactions at first such as ears up, head turned, looking at the ground.
4. Stay at the same flag until your pet resists going into the Boundary Zone.

Phase
3

Days 5 thru 8 - Distraction Phase

Perform three training sessions per day, each lasting 10 to 15 minutes.

Goal:

To train your pet to stay within the Pet Area with distractions outside of the Pet Area.

Setup:

- Program the Static Correction Level on the Receiver Collar to level 2 or higher depending on the reaction results from days 2 thru 4.
- Put a separate non-metallic collar on your pet's neck ABOVE the Receiver Collar and attach a leash.

CAUTION

Be sure the extra collar does not put pressure on the Contact Points.

- Have tiny pieces of treats available (hot dogs or lunch meat work well).
- Have your pet's favorite play toy available.
- Create distractions to tempt your pet to enter the Boundary Zone, such as:
 - Have a family member cross from inside the Pet Area to outside of it.
 - Throw a ball or treat outside of the Pet Area.
 - Have a neighbor walk their pet outside of the Pet Area.
- Gradually increase distraction level. **Never coax or call your pet out of the Pet Area.**

Steps:

1. With full control of your pet on a leash, have the distraction presented.
 2. If your pet does not move toward the distraction, praise and offer a treat.
 3. If your pet does react to the distraction, allow him to go into the Boundary Zone.
 4. Help your pet back into the Pet Area if he does not turn back after 2 seconds.
 5. Treat and praise your pet anytime he comes back into the Pet Area with or without help.
 6. Repeat this process with other distractions. Use other family members during this process.
 7. If your pet does not respond to the Static Correction, confirm that the Receiver Collar is fitting properly according to Step 6 on page 13.
 8. If the Receiver Collar is fitted properly and if your pet does not respond to the Static Correction, increase the Static Correction Level by 1.
-

Phase

4

Days 9 thru 14 - Unleashed Supervision

Training sessions should start at 10-15 minutes, gradually increasing to over an hour.

Your pet is ready for this step only when he clearly avoids the entire Boundary Zone, regardless of any distractions or temptations. During this step, do not leave your pet unattended.

Goal:

To give your pet free run of the Pet Area off the leash.

Setup:

Adjust the Receiver Collar to the permanent setting appropriate for your pet.

Steps:

1. Enter the Pet Area with your pet wearing the Receiver Collar.
2. Walk around the yard and play with your pet, staying within the Pet Area at all times.
3. Preoccupy yourself with another task in the yard while watching your pet.

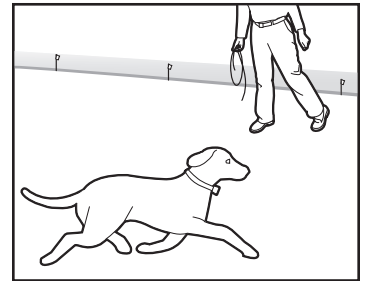

Phase 5 Days 15 thru 30 - Pet Monitoring

5

Your pet is ready to run! Check in on your pet at regular intervals.

Note: After you are satisfied your pet's training is complete, remove every other Boundary Flag every 4 days until all flags are removed. Save Boundary Flags for future use.

Taking Your Pet Out of the Pet Area

Important: Remove the Receiver Collar and leave it in the Pet Area.

Once your pet learns the Boundary Zone, he will be reluctant to cross it for walks or car rides.

Option 1: Replace the Receiver Collar with a regular collar. Put your pet in a car that is within the Pet Area and drive him out of the Pet Area.

Option 2: Replace the Receiver Collar with a regular collar and leash. Walk your pet out of the Pet Area while giving a command such as "OK" at a specific place of the Boundary Zone (the end of your driveway, sidewalk, etc.). Always leave the Pet Area with a leash at this place and your pet will associate leaving the Pet Area only on a leash, only at this place, and only with a person. You may initially need to convince your pet to leave the Pet Area with a food treat and lots of praise.

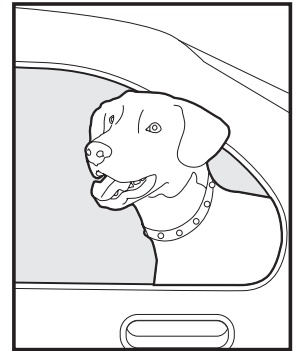

Note: You may also carry your pet out of the Pet Area.

***Congratulations!
You have now
successfully completed
the training program.***

Wireless-To-Go

Your PetSafe® Stay + Play Wireless Fence® is completely portable. Follow the set-up procedures (Steps 1 through 4) wherever you wish to have containment of your pet. Reestablish the Pet Area and mark it with Boundary Flags so your pet knows his Boundary Zone. *Note: If setting up in a metal building or vehicle, the maximum size of the Pet Area may be reduced.* Be sure to remove the Receiver Collar before removing power from the Transmitter. If you want to power the Transmitter from a car or other DC source, use an inverter rated for 50 watts or more.

Accessories

To purchase additional accessories for your PetSafe® Stay + Play Wireless Fence®, contact the Customer Care Center at 1-800-732-2677 or visit our website at www.petsafe.net to locate a retailer near you.

Component	Part Number
Extra Stay + Play Wireless Fence® Receiver Collar (Rechargeable)	PIF00-12918
Extra Stubborn Dog Stay + Play Wireless® Fence Receiver Collar (Rechargeable)	PIF00-13672
Extra Wireless Receiver Collar (Non-Rechargeable)	PIF-275-19
Wireless Transmitter Power Adapter (USA Plug)	RFA-464
Receiver Collar Charger	RFA-463
Extra Boundary Flags	RFA-2
Extra Wireless Transmitter and Adapter	PIF00-13210
Receiver Collar Accessory Pack	RFA-454

Frequently Asked Questions

Is the Receiver Collar waterproof?	<ul style="list-style-type: none"> • Yes.
Will the PetSafe® Stay + Play Wireless Fence® cover a larger circle than 210 feet across?	<ul style="list-style-type: none"> • You can use another Wireless Transmitter with overlapping boundaries of at least 5-10 feet to increase the size of the Pet Area.
Will a sloping yard or hills affect the Pet Area?	<ul style="list-style-type: none"> • The Transmitter signal extends up to 105 feet in all directions. A sloping yard or a yard with hills can cause the Pet Area to appear less or more than expected. Consider repositioning the Transmitter to maximize your Pet Area.
Can I use more than one Receiver Collar with the Stay + Play Wireless Fence®?	<ul style="list-style-type: none"> • Yes. There is no limit to the number of pets you can contain with the Stay + Play Wireless Fence®. You must purchase an additional Wireless Pet Fence Receiver Collar for each pet. Contact the Customer Care Center at 1-800-732-2677 or visit our website at www.petsafe.net to locate a retailer near you.
Will the Stay + Play Wireless Fence® keep other pets out of my yard?	<ul style="list-style-type: none"> • No. The Stay + Play Wireless Fence® is only effective on pets who wear the Receiver Collar.
Is there a hand-held remote Transmitter that will work with the Wireless System Receiver Collar?	<ul style="list-style-type: none"> • No. You would need to purchase a separate Remote Training System. Contact the Customer Care Center at 1-800-732-2677 or visit our website at www.petsafe.net to locate a retailer near you.
If I have a question about my Stay + Play Wireless Fence® or need replacement parts, where can I get answers or service?	<ul style="list-style-type: none"> • Contact the Customer Care Center at 1-800-732-2677 or visit our web site at www.petsafe.net.
Can I use the Stay + Play Wireless Fence® on an aggressive pet?	<ul style="list-style-type: none"> • This product is not for use with aggressive pets. If you are unsure if your dog is aggressive, please consult your veterinarian or a certified trainer.
Can I use the Stay + Play Wireless Fence® on a cat?	<ul style="list-style-type: none"> • The Stay + Play Wireless Fence® can be used as long as the cat can comfortably wear the Receiver Collar.
What happens if the power goes out?	<ul style="list-style-type: none"> • The Stay + Play Wireless Fence® is designed to recognize power outages and shuts down without activating the Receiver Collar. However, if your pet is near the Boundary Zone during the power failure, he may receive a Static Correction. The Transmitter will sound an intermittent alarm for up to 30 minutes to alert you to the power failure.
If my pet leaves the Pet Area, how long will he be corrected?	<ul style="list-style-type: none"> • Your pet will receive Static Correction for up to 15 seconds as long as he is outside the Pet Area.
How often do I need to charge the Receiver Collar battery?	<ul style="list-style-type: none"> • Each charge can last up to 3 weeks depending upon frequency of use. The Receiver Indicator Light acts as a low battery indicator, flashing red every 4 to 5 seconds when battery charging is required.
Can I place the Receiver on another collar?	<ul style="list-style-type: none"> • Yes. You may use any 3/4 inch, non-metallic collar.
Do I need to perform maintenance on my Stay + Play Wireless Fence®?	<ul style="list-style-type: none"> • Check your pet's neck daily for irritation from the Contact Points. • Check the Contact Points on the Receiver Collar weekly to make sure they are clean. • Use the Contact Point Wrench to make sure the Contact Points are secure. Do not over tighten. • Check the fit of the Receiver Collar weekly. • The Receiver Indicator Light acts as a Battery Status Indicator, flashing red every 4 to 5 seconds when battery charging is required.

How do I know the battery in the Receiver Collar is still working?	<ul style="list-style-type: none"> • Check Battery Status Indicator Lights.
Will vehicles, buildings and landscape features (trees, shrubs, etc.) affect the performance of the Stay + Play Wireless Fence®?	<ul style="list-style-type: none"> • Yes. Placing the Transmitter inside a metal building can reduce the maximum range of the Stay + Play Wireless Fence®. • Parking a vehicle within the Pet Area, can reduce the range of the system and cause your pet to receive a Static Correction where it otherwise would not if the vehicle was not there. • Fixed large metal objects such as metal sheds can affect the signal by reducing the maximum range of the system at the location of the object. As a result, your pet may receive a Static Correction.
What do I do if my pet's neck becomes red and irritated?	<ul style="list-style-type: none"> • This condition is due to the Contact Points irritating the skin. Discontinue use of the Receiver Collar for a few days. If the condition persists beyond 48 hours, see your veterinarian. Once the skin returns to normal, replace the Receiver Collar and monitor the skin condition closely.
Can I attach a leash to the Receiver Collar?	<ul style="list-style-type: none"> • No. This can result in pulling the Contact Points too tightly against your pet's neck or the collar may break. Attach a leash to a separate, non-metallic collar positioned above the Receiver Collar.
Why does my Receiver Collar have a tone only mode?	<ul style="list-style-type: none"> • The tone only mode can be used in training your pet to his boundary or for well-trained pets that no longer require Static Correction.
What if my Transmitter alarm is sounding?	<ul style="list-style-type: none"> • A beeping tone indicates power loss. If the Transmitter fails to transmit a proper signal, a continuous alarm will sound. Contact the Customer Care Center at 1-800-732-2677.
The Transmitter is beeping intermittently when I unplug the Power Adapter from the wall outlet.	<ul style="list-style-type: none"> • The Power Loss Alarm in the Transmitter is activated to alert you that power has been removed from the Transmitter and your pet is no longer being contained. To turn off the Power Loss Alarm, unplug the Power Adapter from the Power Jack located on the bottom of the Transmitter or press the Alarm Disable Button for 5 seconds then release.
The Transmitter is generating a loud continuous tone.	<ul style="list-style-type: none"> • The Transmitter has a built in Transmission Failure Alarm that continuously monitors the Transmitter output. If a transmission failure ever occurs the alarm warns you that your pet is no longer being contained. Contact the Customer Care Center for a replacement Transmitter.

Troubleshooting

<p>The Receiver Collar is not beeping when setting up the Boundary Zone.</p>	<ul style="list-style-type: none"> • Make sure Receiver Collar is turned on and Battery Status Lights are flashing every 4-5 seconds • Charge Receiver Collar • The beep may be difficult to hear in a noisy environment. • Use Test Light as explained in the "Test Light Instructions" section, and use it to determine the location of Boundary Zone. • Check that the Transmitter is set up according to directions.
<p>The Receiver Collar is not beeping or administering a Static Correction.</p>	<ul style="list-style-type: none"> • Make sure Receiver Collar is turned on and Battery Status Lights are flashing every 4-5 seconds • Charge Receiver Collar • Check that the Transmitter is plugged into a working 120-volt outlet, the Power Light is on, and the Transmitter controls are set at your desired settings.
<p>The Receiver Collar is beeping everywhere.</p>	<ul style="list-style-type: none"> • Check that the Transmitter is plugged into a working standard 120-volt outlet, the Power Light is on, and the Transmitter controls are set at your desired settings. • Bring Receiver Collar within 10 feet of the Transmitter to reset. • Make sure no continuous alarm is sounding on the Transmitter.
<p>The Receiver Collar is beeping inside the house.</p>	<ul style="list-style-type: none"> • It is recommended to remove the Receiver Collar from your pet when indoors to avoid activation of the Receiver Collar. • Make sure the Transmitter is plugged in and set up according to the directions. • Ensure the entire house is within the Pet Area. The Transmitter may need to be moved to adjust the Pet Area to include the entire house. • If relocating the Transmitter, remove the Receiver Collar from your pet before removing power from the Transmitter.
<p>My pet is receiving a Static Correction in his metal crate.</p>	<ul style="list-style-type: none"> • The Receiver Collar activates when it loses the Transmitter signal. The metal crate may block the Transmitter signal which causes the Receiver Collar to activate. • Remove the Receiver Collar from your pet when placing him in his metal crate.
<p>The Boundary Zone seems to fluctuate.</p>	<ul style="list-style-type: none"> • This is normal for the electro magnetic field of the Stay + Play Wireless Fence®. The field may be affected by surrounding "electronic noise," which can cause it to fluctuate up to 5%. • Where the Receiver Collar activates is influenced by the speed and orientation of the Receiver Collar as your pet enters the Boundary Zone.
<p>The Receiver Collar activates in the middle of the yard.</p>	<ul style="list-style-type: none"> • The Receiver Collar activates when it loses the Transmitter signal. This sometimes occurs if a large metal object is between the Receiver Collar and Transmitter, if the orientation of the Receiver Collar changes near the Boundary Zone, or if the surrounding "electronic noise" interferes with the signal. If this continues to occur, consider relocating the Transmitter and resetting the Pet Area.

<p>The Receiver Collar is beeping but my pet is not responding to the Static Correction.</p>	<ul style="list-style-type: none"> • Make sure the Static Correction Level is set at 2 or above. • Test the Receiver Collar with the Test Light. • If the Test Light flashes, check the fit of the Receiver Collar. • Trim your pet's fur where the Contact Points touch the neck and/or switch to the longer Contact Points. • Contact Points must be in contact with dog's skin. • Increase the Static Correction Level. • Repeat training steps to reinforce training.
<p>My pet reacts strongly to the Static Correction and has become fearful.</p>	<ul style="list-style-type: none"> • Lower the Static Correction Level. • Make sure you are in control of the situation when your pet receives his first Static Corrections (have him on a leash attached to a separate, non-metallic collar) and lead him into the Pet Area and praise him. If your pet remains fearful, suspend training and start again the next day. Make sure to end all training sessions on a positive note with lots of praise and play.
<p>The Transmitter Power Light is not on.</p>	<ul style="list-style-type: none"> • Make sure the Power Light on the Power Adapter is on when plugged into a working 120 volt wall outlet. • If Power Adapter Light is not on, contact the Customer Care Center for a replacement Power Adapter.
<p>I was setting up the Pet Area and after I turned down the Boundary Control Dial, the Receiver Collar would no longer beep or correct.</p>	<ul style="list-style-type: none"> • You may have turned the Boundary Control Dial down too quickly, causing the Receiver Collar to go into power-fail mode. This is a safety feature designed to protect your pet when power to the Transmitter goes out. With the Receiver Collar within 10 feet of the Transmitter, readjust the Boundary Control Dial as shown in Step 4 and reset the Boundary Zone, making sure to turn the dial down slowly.
<p>My next-door neighbor has an In-Ground Containment System and the Receiver Collar does not activate near their property.</p>	<ul style="list-style-type: none"> • Your neighbor's In-Ground Fence signal may interfere with the operation of the Receiver Collar preventing activation close to their fence. To minimize the interference, reduce the size of the Pet Area or move the Transmitter away from the In-Ground Fence System. • Adjust the Pet Area so that the Receiver Collar activates at least 5 feet beyond the reduced Boundary setting when walking towards the In-Ground Fence.
<p>The Receiver Collar has injured my pet's neck.</p>	<ul style="list-style-type: none"> • Failing to follow the important safety information at the front of the Operating and Training Guide has caused pressure ulcers. Some descriptions of advanced pressure ulcers describe the sores as looking like burns on the dog's neck. Be assured that electronic collars do not use enough energy to create electrical burns. The energy in an output pulse is only a few thousandths of a Joule; it is similar in nature to the static pulse that you may feel when getting out of your car. In some cases, pressure ulcers are described as chemical burns. The battery in your Receiver Collar is sealed, in addition, your collar's housing is also sealed. This redundant sealing makes it virtually impossible, without misuse or abuse, for your Receiver Collar battery to leak onto your pet's neck. Please review and follow the important safety information on page 2, and the instructions in Step 6 under the heading "Fit the Receiver Collar" on pages 13 and 14.

Terms of Use and Limitation of Liability

1. Terms of Use

This Product is offered to you conditioned upon your acceptance without modification of the terms, conditions and notices contained herein. Usage of this Product implies acceptance of all such terms, conditions, and notices.

2. Proper Use

This Product is designed for use with pets where training is desired. The specific temperament of your pet may not work with this Product. If you are unsure whether this is appropriate for your pet, please consult your veterinarian or certified trainer.

3. No Unlawful or Prohibited Use

This Product is designed for use with pets only. This pet training device is not intended to harm, injure or provoke. Using this Product in a way that is not intended could result in violation of Federal, State or local laws.

4. Limitation of Liability

In no event shall Radio Systems® Corporation be liable for any direct, indirect, punitive, incidental, special or consequential damages, or any damages whatsoever arising out of or connected with the use or misuse of this Product. Buyer assumes all risks and liability from the use of this Product.

5. Modification of Terms and Conditions

Radio Systems® Corporation reserves the right to change the terms, conditions and notices under which this Product is offered.

Compliance

USA/Canada

This equipment has been tested and found to comply with the limits for a Class B digital device, pursuant to Part 15 of the FCC Rules. These limits are designed to provide reasonable protection against harmful interference when the equipment is operated in a residential environment.

This equipment generates, uses, and can radiate radio frequency energy and, if not installed and used in accordance with the instruction guide, may cause harmful interference to radio communications. However, there is no guarantee that interference will not occur in a practical installation. If this equipment causes harmful interference to radio or television reception, which can be determined by turning the equipment off and on, the user is encouraged to try to correct the interference by one or more of the following measures:

- Relocate the interfered receiving antenna.
- Increase the separation between the equipment and receiver.
- Connect the equipment into an outlet on a circuit different from that to which the receiver is connected.
- Contact the Customer Care Center at 1-800-732-2677.

This device complies with part 15 of the FCC Rules. Operation is subject to the following two conditions:

(1) This device may not cause harmful interference, and (2) this device must accept any interference received, including interference that may cause undesired operation.

This device complies with Industry Canada licence-exempt RSS standard(s). Operation is subject to the following two conditions: (1) this device may not cause interference, and (2) this device must accept any interference, including interference that may cause undesired operation of the device.

Unauthorized changes or modifications to the equipment, not approved by Radio Systems® Corporation, could result in not meeting compliance with FCC or IC regulations and void the user's authority to operate the equipment.

Australia

This device complies with the applicable EMC requirements specified by the ACMA (Australian Communications and Media Authority).

Warranty

One Year Non-Transferrable Limited Warranty

This Product has the benefit of a limited manufacturer's warranty. Complete details of the warranty applicable to this Product and its terms can be found at www.petsafe.net.

Australia/New Zealand - In compliance with the Australian Consumer Law, Warranties Against Defects, effective January 1, 2012, warranty details of this Product are as follows:

One Year Non-Transferrable Limited Warranty

What is covered: Radio Systems Australia Pty Ltd (hereinafter referred to as "Radio Systems") warrants to the original retail purchaser, and not any other purchaser or subsequent owner, that its Product, when subject to normal and proper residential use, will be free from defects in material or workmanship for a period of one (1) year from the purchase date. An "original retail consumer purchaser" is a person or entity who originally purchases the Product, or a gift recipient of a new Product that is unopened and in its original packaging. When serviced by Radio Systems Customer Service, Radio Systems covers labor and parts for the first year of ownership; after the first year, a service or upgrade charge will apply relative to replacement of the Product with new or refurbished items at Radio System's sole discretion.

The limited warranty is non-transferrable and shall automatically terminate if the original retail consumer purchaser resells the Radio Systems Product or transfers the property on which the Radio Systems Product is installed. This Limited Warranty excludes accidental damage due to dog chews; lightning damage; or neglect, alteration, and misuse. Consumers who **purchase Products outside of Australia, New Zealand, or from an unauthorized dealer will need to return the Product to the original place of purchase for any warranty issues.**

Please note that Radio Systems does not provide refunds, replacements, or upgrades for change of mind, or for any other **reason outside of these Warranty terms.**

Customer Care International

USA & Canada - Tel: 800-732-2677

Monday - Friday 8 AM - 8 PM / Saturday 9 AM - 5 PM

Australia - Tel: 1800 786 608

Monday - Friday 7:30 AM - 5 PM

New Zealand - Tel: 0800 543 054

Monday - Friday 10:30 AM - 7 PM

This product has the benefit of a limited manufacturer's warranty. Details of the warranty applicable to this product and its terms can be found at www.petsafe.net and/or are available by sending a stamped addressed envelope to PetSafe® Ltd. Redthorn House, Unit 9, Chorley West Business Park, Ackhurst Road, Chorley, Lancashire PR7 1NL, United Kingdom.



Mounting Template

2 1/2 INCHES (63.5mm)

Radio Systems® Corporation
10427 PetSafe Way
Knoxville, TN 37932
1-800-732-2677
www.petsafe.net
Protected by US Patents 6,879,300
and 7,142,167.
Other patents pending.

400-1243/3

©2013 Radio Systems Corporation