



TABLE OF CONTENTS

1. PACKAGE CONTENTS / SYSTEM REQUIREMENTS	2
2. DEVICE LAYOUT	3
3. SETTING UP THE OSVR HACKER DEVELOPMENT KIT	6
4. WEARING THE HEAD-MOUNTED DISPLAY MODULE	8
5. SETTING UP YOUR IR POSITIONAL TRACKING CAMERA (OPTIONAL)	10
7. CONFIGURING YOUR OSVR HACKER DEVELOPMENT KIT	13
8. SAFETY AND MAINTENANCE.....	17
9. REGULATORY STATEMENT.....	20
10. LEGALESE.....	23

1. PACKAGE CONTENTS / SYSTEM REQUIREMENTS

PACKAGE CONTENTS

- Head-Mounted Display (hmd) module with removable IR sensor box for 360° positional tracking
- Belt box module
- HDMI & USB 3.0 combo cable
- IR positional tracking faceplate or Leap Motion faceplate (model: vr17-c14117)
- IR positional tracking camera
- Camera stand
- USB camera cable
- Split cable for power and IR camera synchronization signal
- Air puffer with removable brush
- Power supply kit*
- Important Product Information Guide

** May include adapter plugs or power cords for specific regions.*

MINIMUM SYSTEM REQUIREMENTS

- i5 3Ghz CPU or better
- GPU: NVIDIA GTX 970/AMD R9 290
- At least 8GB system memory
- 1 x USB 2.0 port
- HDMI 1.3 compatible port

2. DEVICE LAYOUT

HEAD-MOUNTED DISPLAY MODULE

(Dual-Screen model: VR17-C14122)

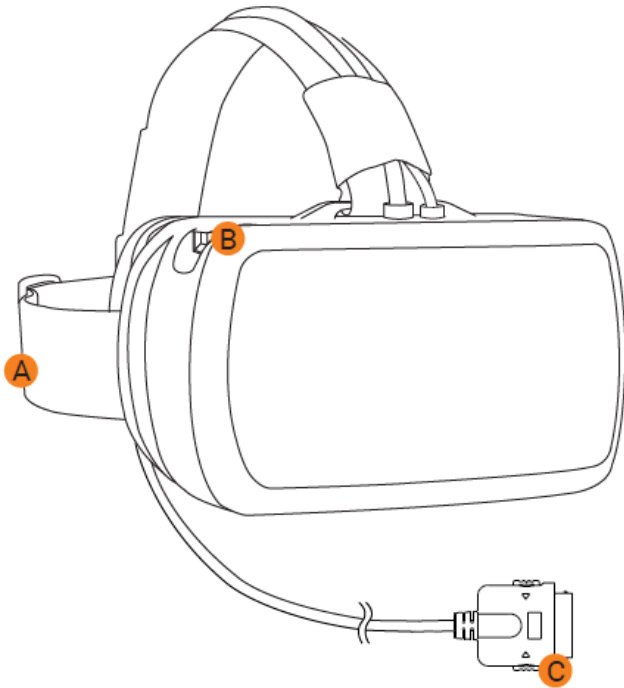

Perspective View

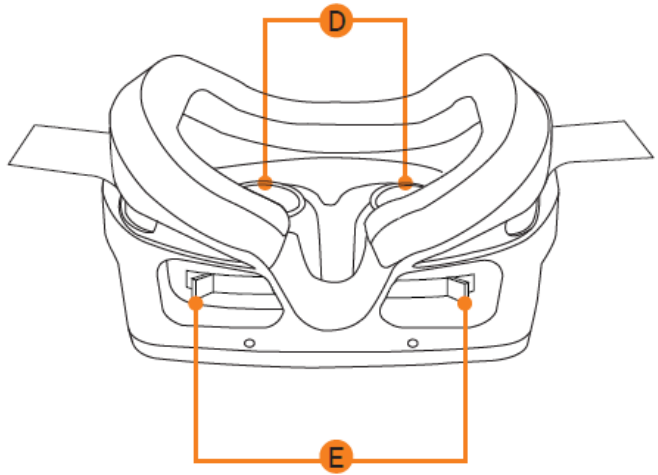

Bottom View

- A. Adjustable head straps
- B. External USB 3.0 expansion port
- C. Dedicated HMD connector
- D. Adjustable optic lenses
- E. Independent adjustment lever per each eye

BELT BOX MODULE

BELT BOX MODULE

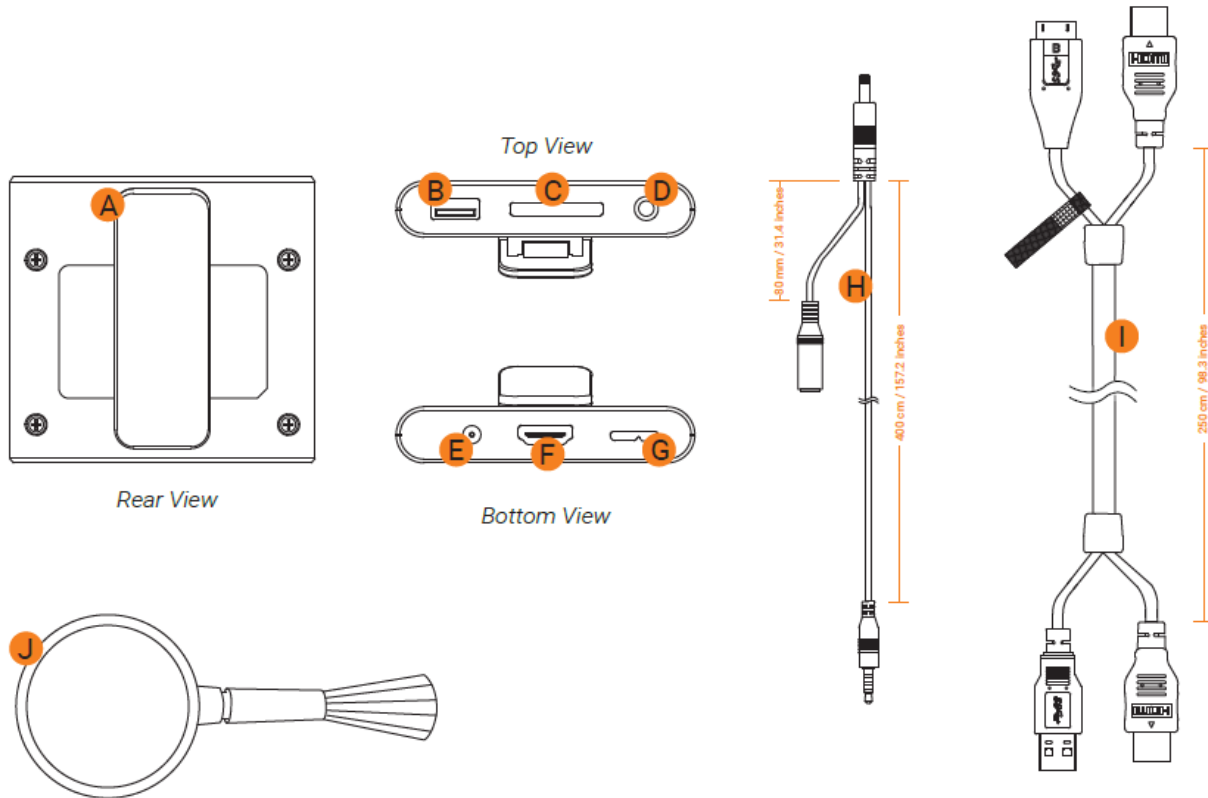

- A. Belt Clip
- B. External USB 3.0 expansion port
- C. Dedicated HMD port
- D. 3.5mm audio jack with microphone input
- E. Power Jack
- F. HDMI connector
- G. USB 3.0 connector
- H. Split cable for power and IR camera synchronization signal
- I. HDMI & USB combo cable
- J. Air puffer with removable brush

IR POSITIONAL TRACKING KIT

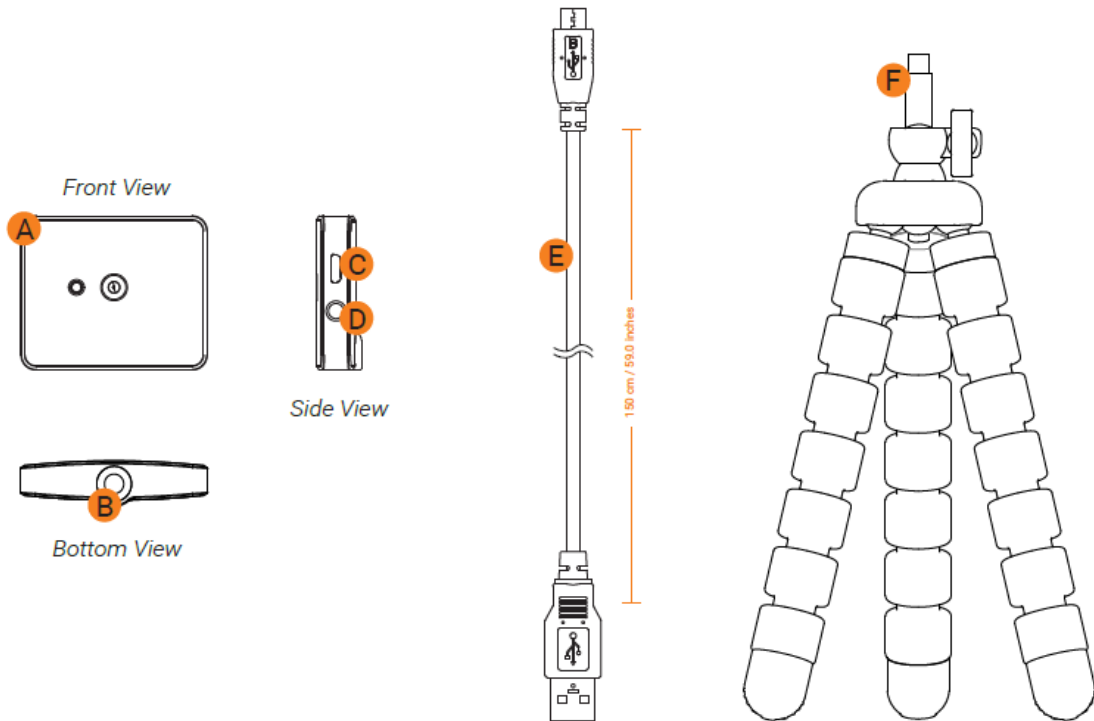

- A. IR Positional Tracking camera
- B. Mounting hole
- C. Micro-USB port
- D. 3.5mm split cable port
- E. USB camera cable
- F. Camera stand

3. SETTING UP THE OSVR HACKER DEVELOPMENT KIT

1. Connect the dedicated HMD connector to the Belt Box Module.

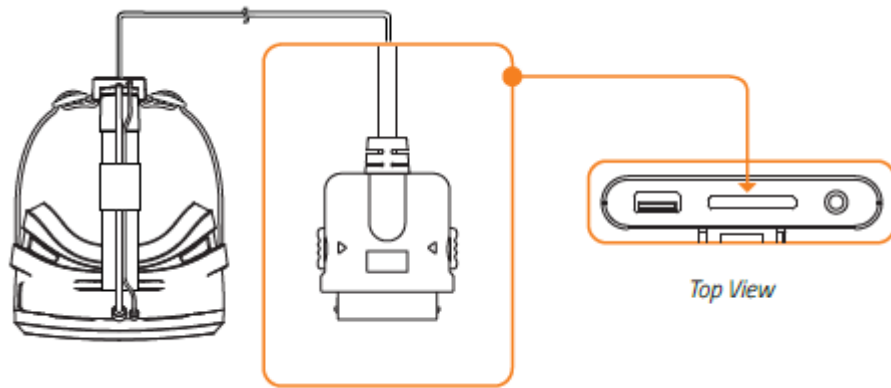

2. Connect the HDMI & USB 3.0 combo cable to the Belt Box Module.

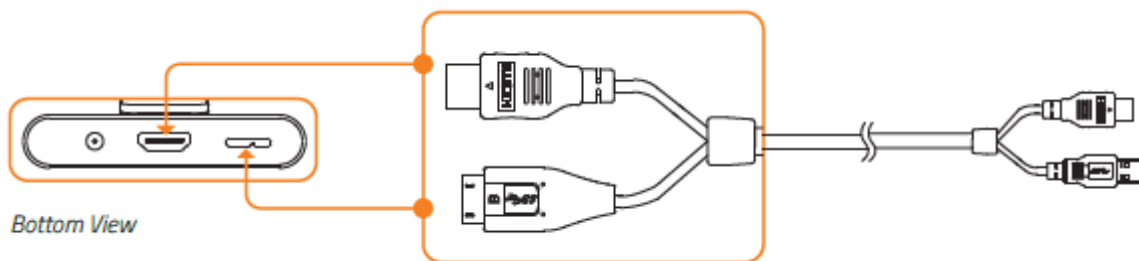

3. Connect the HDMI & USB 3.0 combo cable to your PC.

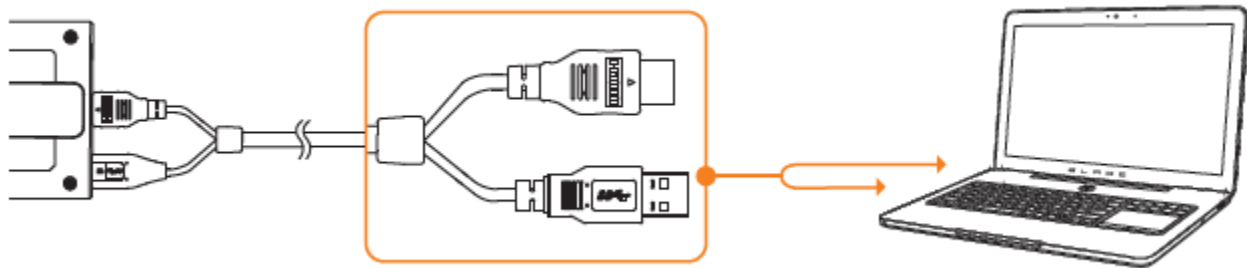

4. Connect the Belt box plug of the split cable into the Belt Box Module.

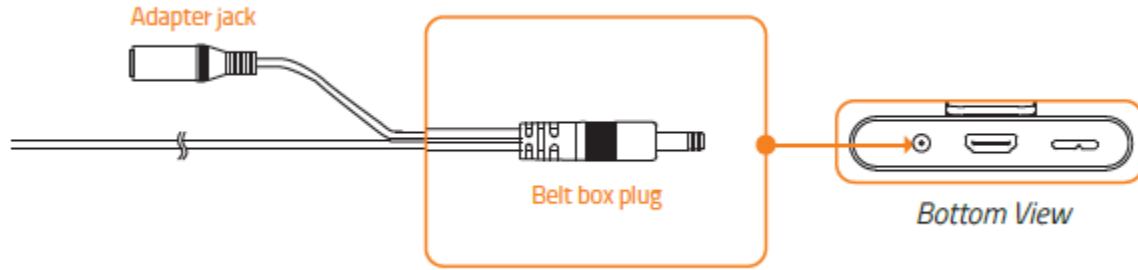

5. Connect the Adapter jack of the split cable into the power adapter's Adapter plug and then plug into a power outlet.

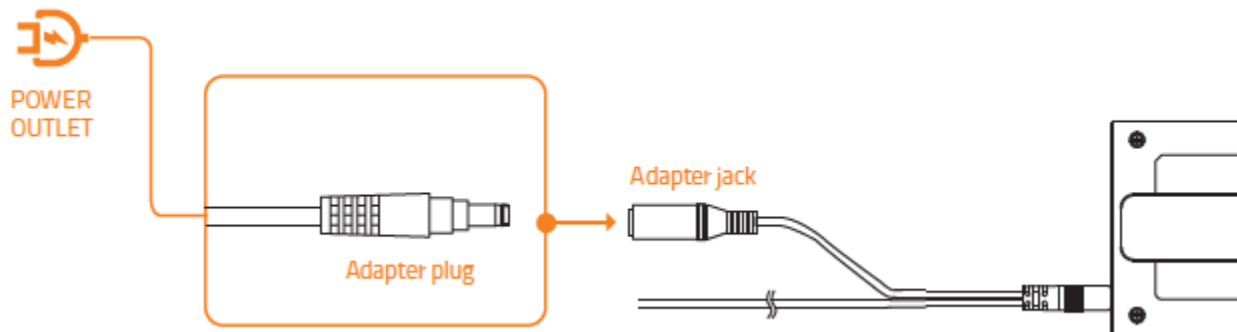

6. Secure the belt clip to your clothing and the cables to the cable fastener.

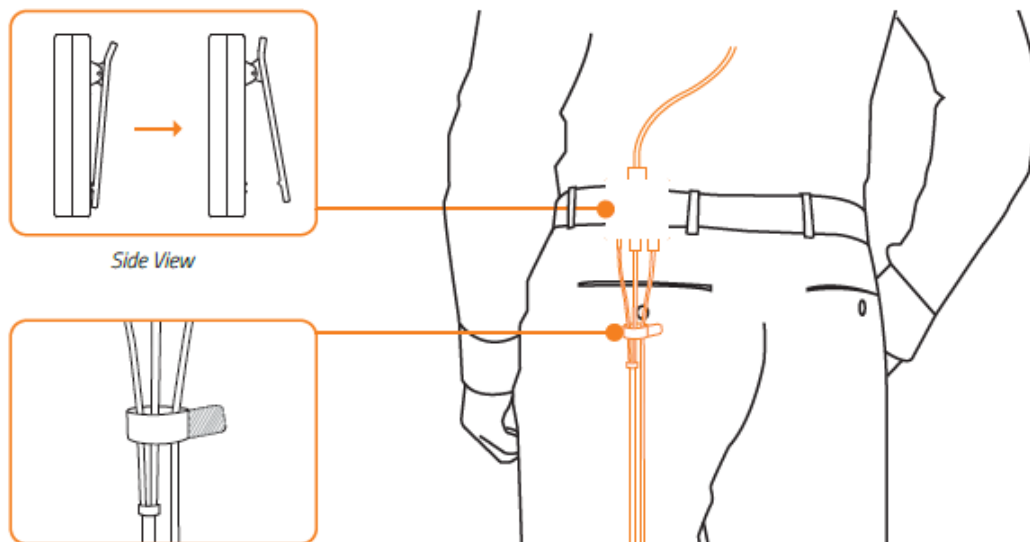

7. Download and run the HDK software from osvr.github.io
For Leap Motion software, visit leapmotion.com/setup

4. WEARING THE HEAD-MOUNTED DISPLAY MODULE

1. Remove the protective lens caps.

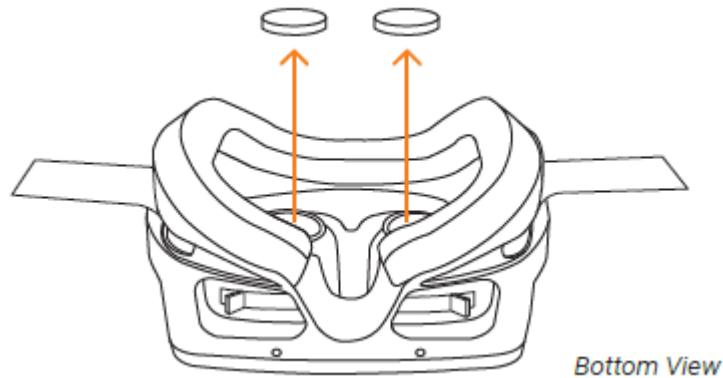

2. Loosen or tighten the over-the-head strap to a comfortable fit.

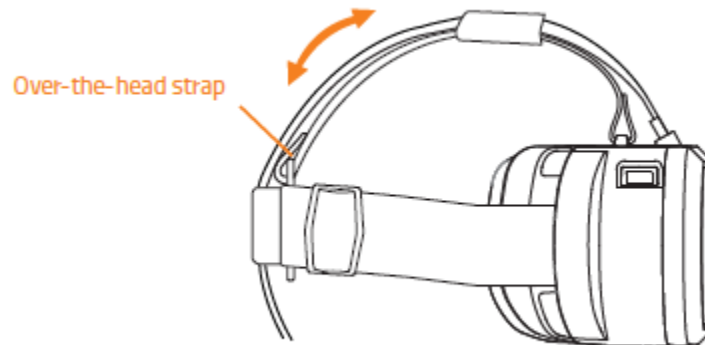

Note: Tightening the over-the-head strap can reduce the pressure of the HMD onto the nose and face. If you feel that you can't breathe properly or that the device is pressing too hard on your cheekbones, the strap is set too long. This can also help redistribute the weight to make the device feel lighter.

3. If you need to adjust the thick cable, gently pull it from the strap box.

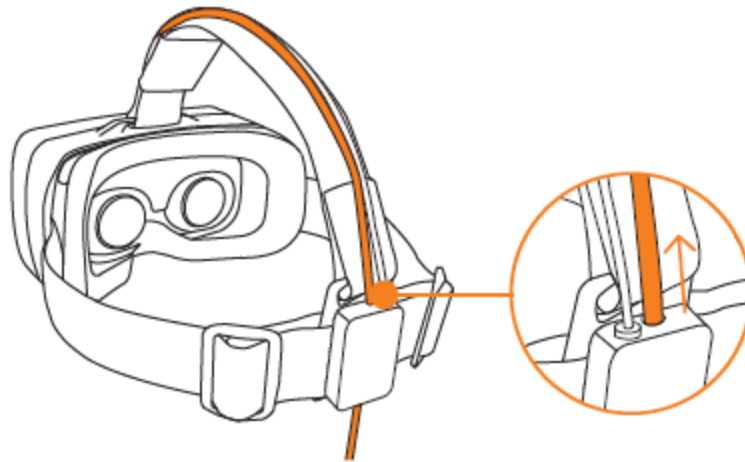

4. Pull the lateral head strap fasteners for a more secure fit.

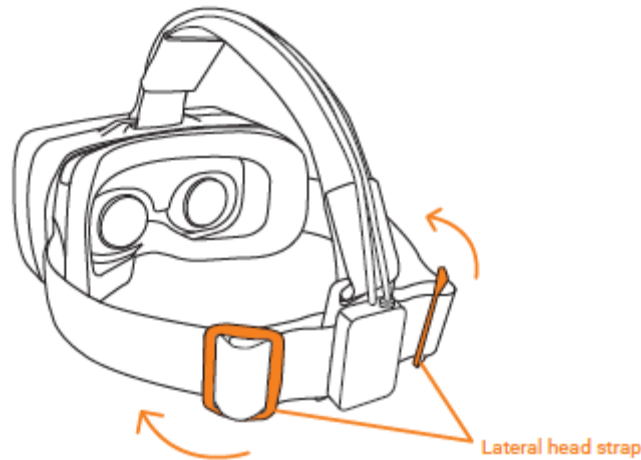

5. Adjust the lenses by moving the independent focal adjustment levers to match your vision.

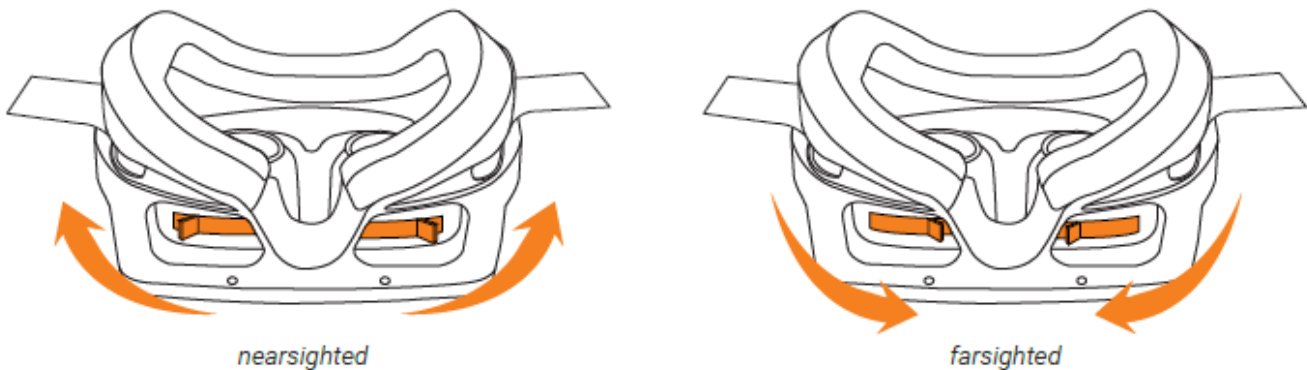

5. SETTING UP YOUR IR POSITIONAL TRACKING CAMERA (OPTIONAL)

1. Mount the IR Positional Tracking Camera to the camera stand.

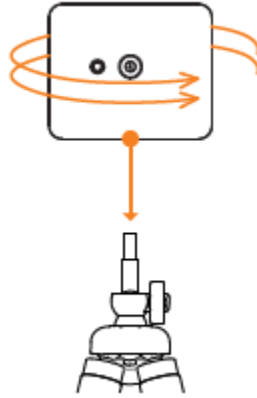

2. Place the IR Positional Tracking Camera near your monitor.

Note: Ensure that the camera is within the same level as the HMD for tracking to work properly. Move mirrors and other reflective objects that are visible to the camera.

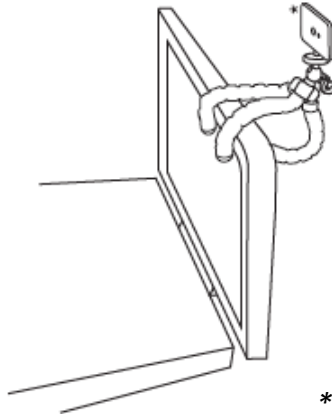

**Recommended Camera Placement*

3. Connect the IR Positional Tracking Camera to your PC.

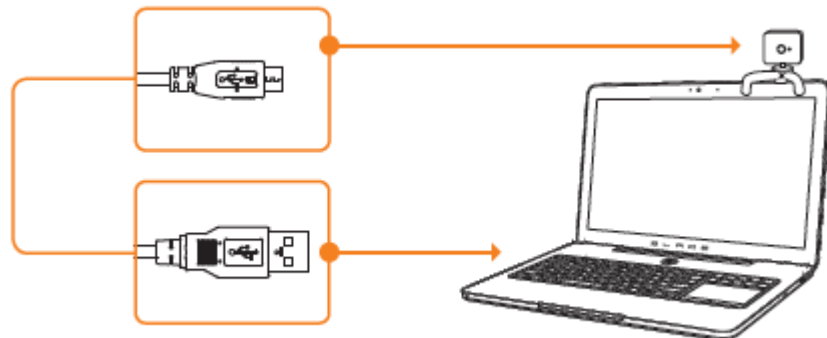

4. Connect the IR camera sync plug of the Split Cable to the IR Positional Tracking Camera.

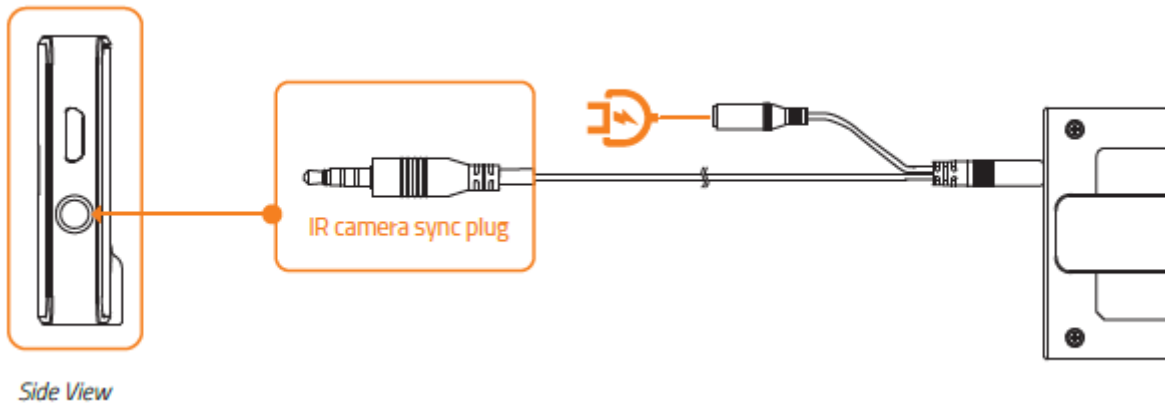

5. Position yourself within 3 meters in front of the IR Positional Tracking Camera.

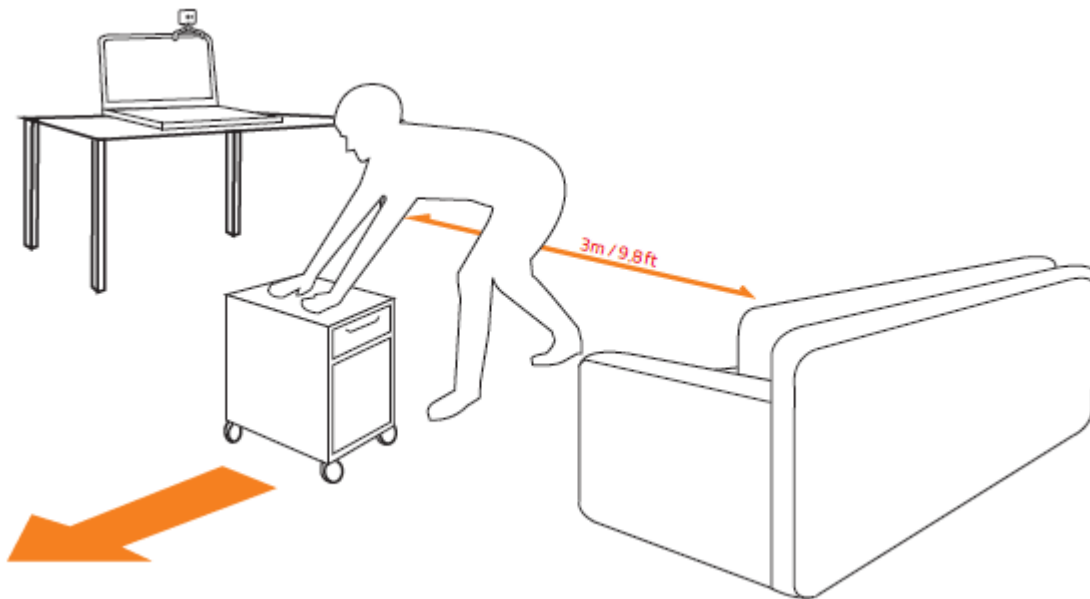

Note: Ensure that your position is free of clutter and moving objects. For optimal performance, use the OSVR Hacker Development Kit in a dimly lit room.

ADDITIONAL LINKS

For inquiries, please refer to these links:

For End Users:

- Available content experiences: osvr.org/featured.html
- Essential software and FAQs: osvr.org/gettingstarted.html
- HDK Support: razersupport.com/osvr-hacker-dev-kit
- Leap Motion Support: leapmotion.com/support
- Website: osvr.org
- Facebook: facebook.com/OpenSourceVR
- Twitter: twitter.com/opensource_vr

For Developers

- Developer Portal: developer.osvr.org
- Developer Wiki: wiki.osvr.org

7. CONFIGURING YOUR OSVR HACKER DEVELOPMENT KIT

Disclaimer: The features listed here require you to log in to Razer Synapse. These features are also subject to change based on the current software version and your Operating System.

DEVICE SUMMARY TAB

The Device Summary tab is the default tab for OSVR Hacker Development Kit. Here you can view the device's HDK model, firmware version, sensor class, polling rate, and other related input devices. Additionally, the Device Summary tab allows you to launch the OSVR Hacker Development Kit Configurator, open the OSVR Developer Resources website, and open or download the Razer Cortex app.

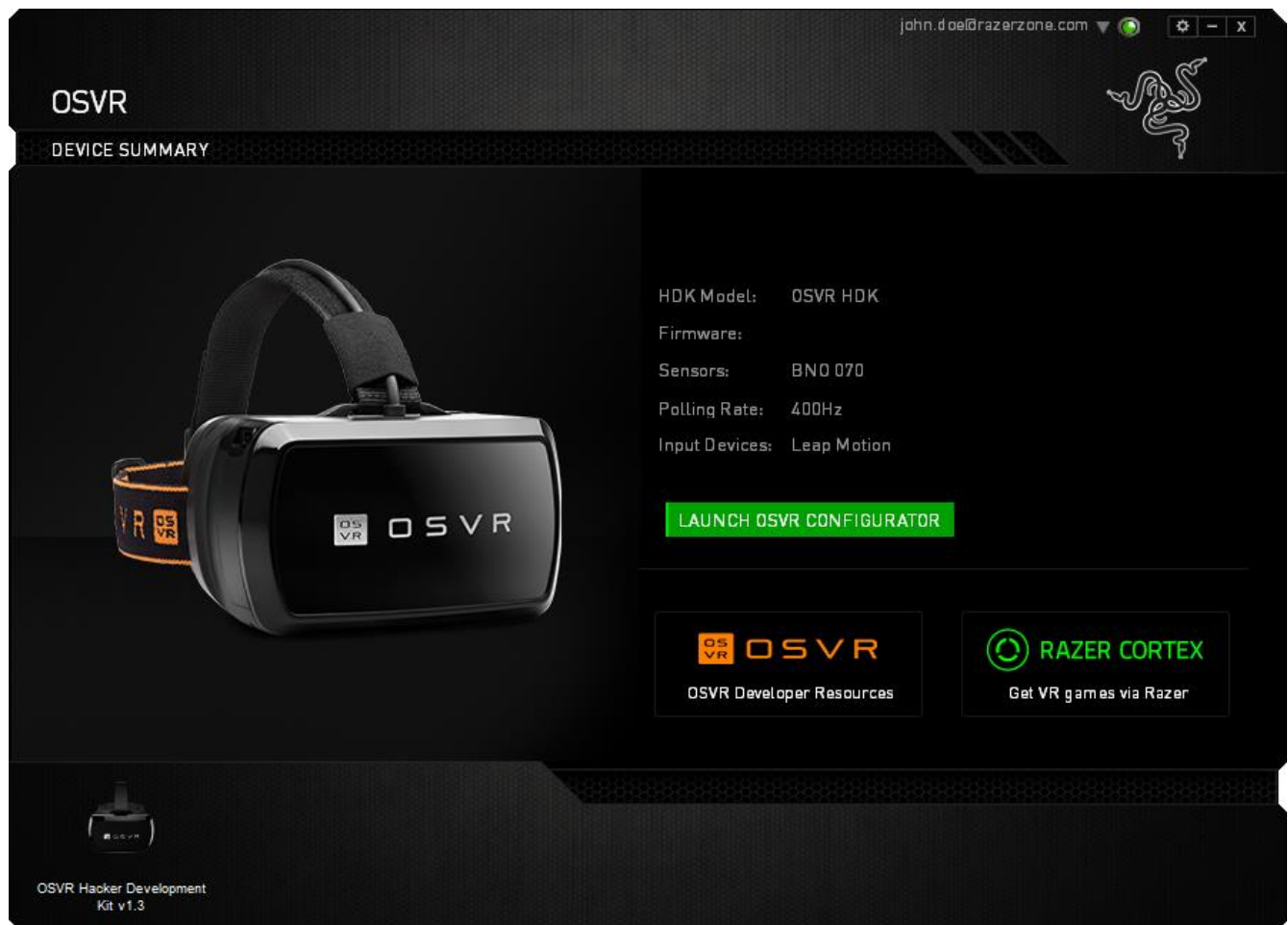

When you click *LAUNCH OSVR CONFIGURATOR*, a new window will appear where you can set your profile, configure your OSVR Hacker Development Kit, edit settings and view OSVR Hacker Development Kit related content.

PROFILE TAB

The Profile tab allows you to setup your user profile to be used by various VR apps that support the OSVR Hacker Development Kit. In this tab you can select your gender, height, and provide other personal information. If you do not wish disclose any, you can select Guest Mode instead.

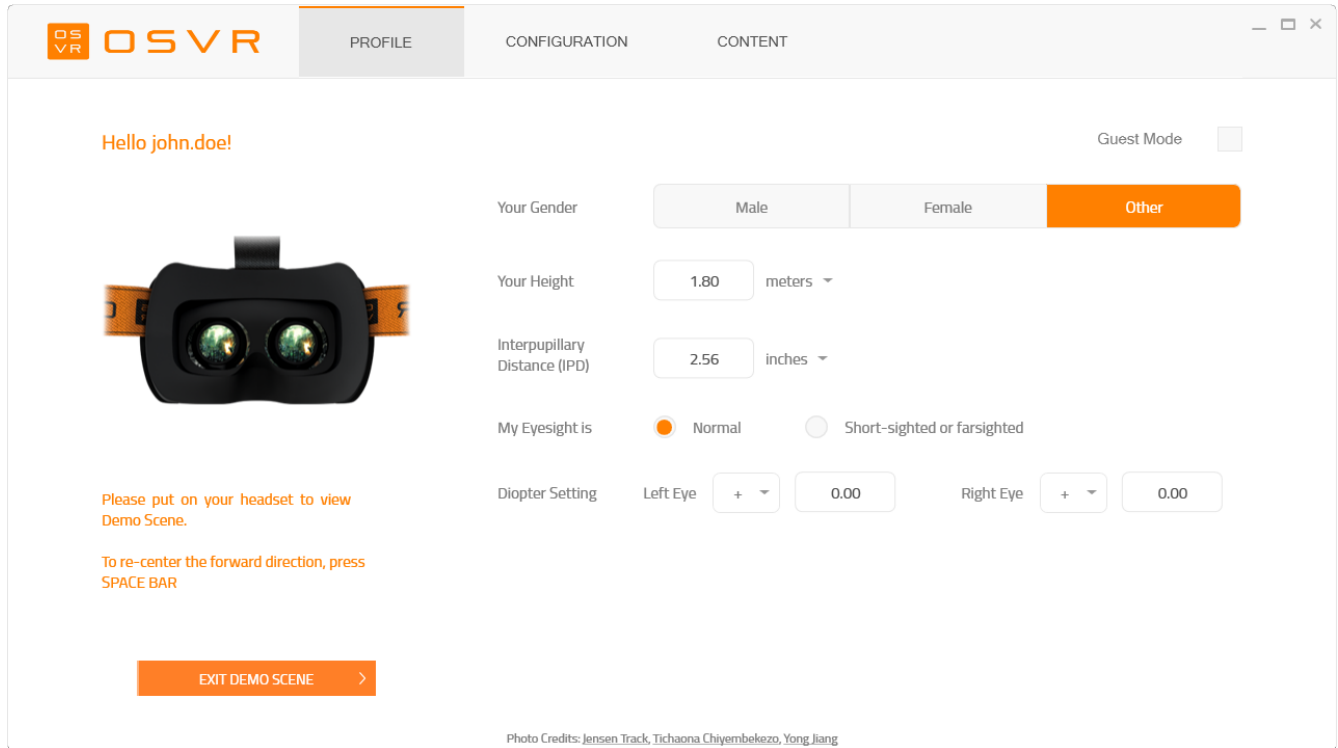

The screenshot shows the OSVR Profile tab interface. At the top, there are three tabs: PROFILE (selected), CONFIGURATION, and CONTENT. The main content area is divided into two columns. The left column features a VR headset image, a greeting "Hello john.doe!", and instructions: "Please put on your headset to view Demo Scene." and "To re-center the forward direction, press SPACE BAR". Below these instructions is an orange button labeled "EXIT DEMO SCENE" with a right-pointing arrow. The right column contains a "Guest Mode" checkbox (unchecked) and several input fields: "Your Gender" with buttons for "Male", "Female", and "Other" (selected); "Your Height" with a text input "1.80" and a unit dropdown "meters"; "Interpupillary Distance (IPD)" with a text input "2.56" and a unit dropdown "inches"; "My Eyesight is" with radio buttons for "Normal" (selected) and "Short-sighted or farsighted"; and "Diopter Setting" with "Left Eye" and "Right Eye" sections, each containing a "+" and "-" button and a text input "0.00". At the bottom right, there is a small text credit: "Photo Credits: Jensen Track, Tichaona Chiyembekezo, Yong Jiang".

The Profile tab also allows you to quickly configure your interpupillary distance, eyesight, and dioptre settings using the demo scene.

CONFIGURATION TAB

The Configuration tab provides a step-by-step guide for setting up your user profile.

The screenshot shows the OSVR Configuration tab in a browser window. The window title bar includes the OSVR logo and three tabs: PROFILE, CONFIGURATION (selected), and CONTENT. Below the tabs is a progress indicator with three steps: 1. Create Profile (active), 2. Eye-to-Lens Distance, and 3. Interpupillary Distance. The main content area contains a form for personalizing the VR experience. It includes a heading: "Personalize your VR experience by entering information about yourself." The form fields are: "Your Gender" with radio buttons for Male, Female, and Other (selected); "Your Height" with a text input field containing "1.80" and a "meters" dropdown; "My Eyesight is" with radio buttons for Normal (selected) and Short-sighted or farsighted. Below these is a note: "If you know your diopter setting from your optometrist, enter it below. Leave it blank if you are unsure." The "Diopter Setting" section has two columns: "Left Eye" with a "+" dropdown and a text input field containing "0.00", and "Right Eye" with a "+" dropdown and a text input field containing "0.00". At the bottom left of the form is an orange "NEXT >" button.

CONTENT TAB

The Content tab gives you access to OSVR developer resources such as a guide for developing with OSVR, using the OSVR Hacker Development Kit, and contributing to the OSVR SDK.

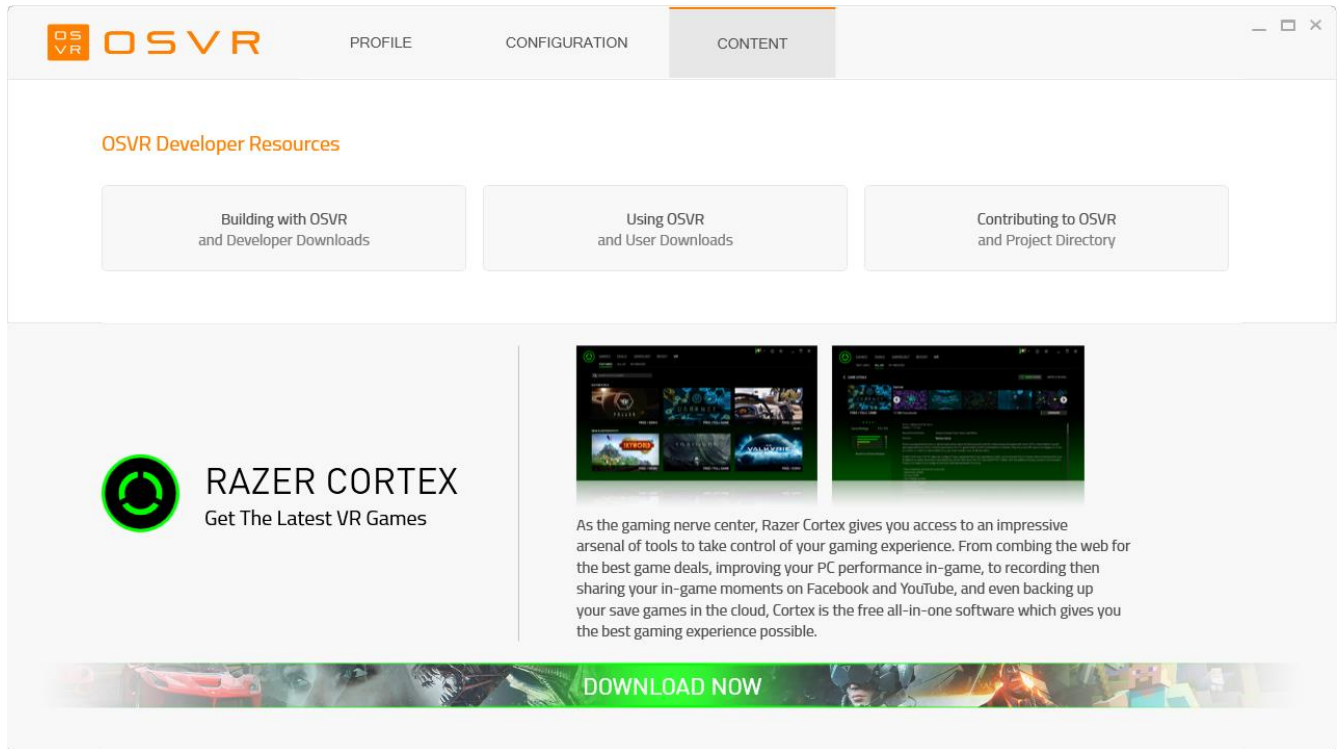

The screenshot shows the OSVR web application interface. At the top, there is a navigation bar with the OSVR logo on the left and three menu items: PROFILE, CONFIGURATION, and CONTENT. The CONTENT menu item is highlighted with an orange underline. Below the navigation bar, the main content area is titled "OSVR Developer Resources" in orange text. Underneath this title, there are three light gray rectangular buttons with rounded corners. The first button contains the text "Building with OSVR and Developer Downloads". The second button contains "Using OSVR and User Downloads". The third button contains "Contributing to OSVR and Project Directory". Below these buttons, there is a large promotional banner for Razer Cortex. On the left side of the banner, there is a green circular logo with a white 'C' inside, followed by the text "RAZER CORTEX" in a large, bold, black font, and "Get The Latest VR Games" in a smaller black font below it. To the right of the text, there are two small screenshots of the Razer Cortex software interface. Below the screenshots, there is a paragraph of text: "As the gaming nerve center, Razer Cortex gives you access to an impressive arsenal of tools to take control of your gaming experience. From combing the web for the best game deals, improving your PC performance in-game, to recording then sharing your in-game moments on Facebook and YouTube, and even backing up your save games in the cloud, Cortex is the free all-in-one software which gives you the best gaming experience possible." At the bottom of the banner, there is a green button with the text "DOWNLOAD NOW" in white, set against a background of various VR game scenes.

8. SAFETY AND MAINTENANCE

Ensure that you have read the warnings below carefully before using the OSVR Hacker Development Kit to reduce the risk of accidents, personal injury, discomfort, and/or property damage.

COMFORT

Make sure the headset is properly levelled on your head and that the screen only shows a single clear image. Adjust the straps properly; too tight and it will pinch your ears or too loose and it will slide down your head. Remove the foam inserts if you still find the headset sliding down your nose. Avoid wearing glasses when using the headset, doing so may cause discomfort and facial injuries. If you have poor eyesight, it is recommended that you customize the independent distance adjustment knobs to better suit your eyes or wear contact lenses.

Ease into the use of the headset to allow your body to adjust; use the device only a few minutes at a time for the first few days then increase the amount gradually as you grow accustomed to virtual reality. Do not use the device when you are tired, need sleep, are under the influence of alcohol or drugs, as this can increase your susceptibility to adverse symptoms. Take a 10 to 15 minute break every hour, even if you don't think you need it. Each person is different, so take more frequent and longer breaks if you feel discomfort. If the virtual-reality experience does not require lower body movement, remain seated at all times.

SAFETY GUIDELINES

In order to achieve maximum safety while using your OSVR Hacker Development Kit, we suggest that you adopt the following guidelines:

1. Should you have trouble operating the device properly, unplug and/or remove the device and go to osvr.org/support.html for assistance. Do not attempt to fix the device yourself.
2. Do not take apart the device (doing so will void your 30-day warranty) and do not attempt to operate it under abnormal current loads.
3. Do not expose the device to liquids. Exposing the product to these conditions may result in an electric shock.

4. Do not use abrasive cleaners and/or harsh cleaning agents to clean the headset.
5. Do not expose the device to extremely high or low temperatures such as leaving the headset in direct sunlight or in snowy weather for extended periods of time.
6. Do not expose the device to open flames such as stoves, candles, or fireplaces.
7. Dispose the product in accordance with your local environmental laws and guidelines.
8. Do not use the product if any cable is damaged or any wires are exposed. Doing so may result in an electric shock.
9. Use only the power adapter provided with the product to avoid short-circuiting the system.
10. Do not tamper or abuse the product; including but not limited to dropping, shaking, crushing, excessive bending, puncturing, shredding, or inserting foreign objects into the device.
11. Do not expose the device to fine solid objects such as dust, dirt, and sand.
12. Avoid placing the product near devices that emit radio waves such as mobile phones, radio transmitters and Wi-Fi routers as it can be affected by their magnetic interference.
13. Stop using the device if you feel that the headset too warm. Prolonged contact with an overheated device can cause skin damage.

MAINTENANCE

Use the puffer with removable brush to ensure that the lenses are clean. Keep the lenses scratch-free for clear visibility. Keep your face clean and dry when wearing the HMD module to prevent dirt buildup and to avoid deteriorating the quality of the foam cushions. Do not paint the OSVR Hacker Development Kit. Paint can clog the device's moving parts or ventilation openings and prevent proper operation.

HEALTH WARNING

Some people may experience severe dizziness, seizures, epileptic seizures or blackouts triggered by light flashes or patterns. This may occur while watching TV, playing video games, or experiencing virtual reality, even if they have no history of blackouts, seizures, or epilepsy. Anyone who has had a seizure, loss of awareness, or other symptoms linked to an epileptic condition should see a doctor before using the headset. We also recommend seeing a doctor before using the headset if you are pregnant, elderly, or suffering from a heart condition or other serious medical condition. Immediately discontinue use if you experience seizures, loss of awareness, eye strain, eye or muscle twitching, involuntary movements, altered, blurred, or double vision or other visual abnormalities. Do not use the device if you have symptoms of squint, amblyopia, or anisometropia as this device may aggravate these symptoms.

The headset produces an immersive virtual reality experience that can distract the user from and completely blocks his view of the actual surroundings. Always be aware of your surroundings when using the headset. Remain seated whenever possible and take special care to ensure that you are not near other people, objects, stairs, balconies, windows, furniture, or other items that you can trip over, bump into, or knock down when using—or immediately after using—the headset. Do not handle sharp or otherwise dangerous objects while using the device. Never wear the headset in situations that require attention, such as walking, bicycling, or driving.

It is not advisable for children under the age of thirteen to watch videos or play games using the device as it may affect their visual development. Prolonged usage could negatively impact hand-eye coordination, balance, and multi-tasking ability in children. Keep the headset and all its parts and accessories out of the reach of small children to avoid accidents and/or injuries.

When using the OSVR Hacker Development Kit, limit your usage time and ensure that you take frequent breaks. Stop using the device the moment you feel any discomfort. People who are prone to motion sickness may also experience the same discomfort when using the device. Immediately stop using the device the moment you feel sick, dizzy, disoriented, excessively sweaty, lightheaded, or drowsy. Do not use the device when suffering from a cold, flu, headache, migraine, or earache as this can increase your susceptibility to adverse symptoms. Do not use the device until all symptoms have completely subsided for several hours. Make sure you have properly configured the product before resuming use.

9. REGULATORY STATEMENT

FCC DECLARATION OF CONFORMANCE

This equipment has been tested and found to comply with the limits for a Class B digital device, pursuant to part 15 of the FCC Rules. These limits are designed to provide reasonable protection against harmful interference in a residential installation. This equipment generates, uses and can radiate radio frequency energy and, if not installed and used in accordance with the instructions, may cause harmful interference to radio communications. However, there is no guarantee that interference will not occur in a particular installation. If this equipment does cause harmful interference to radio or television reception, which can be determined by turning the equipment off and on, the user is encouraged to try to correct the interference by one or more of the following measures:

- Reorient or relocate the receiving antenna.
- Increase the separation between the equipment and the receiver.
- Connect the equipment into an outlet on a circuit different from that to which the receiver is connected.
- Consult the dealer or an experienced radio TV technician for help.

For more information, refer to the online help system on osvr.org.

FCC CAUTION

Any changes or modifications not expressly approved by the party responsible for compliance could void the user's authority to operate this equipment.

This device complies with Part 15 of the FCC Rules.

Operation is subject to the following two conditions:

- (1) This device may not cause harmful interference, and
- (2) This device must accept any interference received, including interference that may cause undesired operation.

INDUSTRY CANADA COMPLIANCE STATEMENT

This Class B digital apparatus complies with Canadian ICES-003.

Cet appareil numérique de la classe B est conforme à la norme NMB-003 du Canada.

Statement for CE;

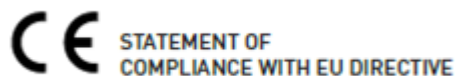

ENGLISH

STATEMENT OF COMPLIANCE WITH EU DIRECTIVE

Hereby, Razer (Europe) GmbH, declares that this OSVR Hacker Development Kit is in compliance with the essential requirements and other relevant provisions of Directive 2004/108/EC.

FRANÇAIS

DÉCLARATION DE CONFORMITÉ AVEC LES DIRECTIVES DE L'UNION EUROPÉENNE

Par la présente Razer (Europe) GmbH déclare que l'appareil Razer OSVR Hacker Development Kit est conforme aux exigences essentielles et aux autres dispositions pertinentes de la directive 2004/108/EC.

ITALIAN

DICHIARAZIONE DI CONFORMITA' CON LE DIRETTIVE EU

Con la presente Razer (Europe) GmbH dichiara che questo OSVR Hacker Development Kit è conforme ai requisiti essenziali ed alle altre disposizioni pertinenti stabilite dalla direttiva 2004/108/EC.

DEUTSCH

EG-KONFORMITÄTSERKLÄRUNG

Hiermit erklärt Razer (Europe) GmbH, dass sich dieser/diese/dieses OSVR Hacker Development Kit in Übereinstimmung mit den grundlegenden Anforderungen und den anderen relevanten Vorschriften der Richtlinie 2004/108/EC befindet.

ESPAÑOL

DECLARACIÓN DE CONFORMIDAD CON LA DIRECTIVA DE LA UE

Por medio de la presente Razer (Europe) GmbH declara que el OSVR Hacker Development Kit cumple con los requisitos esenciales y cualesquiera otras disposiciones aplicables o exigibles de la Directiva 2004/108/EC.

PORTUGUÊS

DIRECTIVA DA UE COM DECLARAÇÃO DE CONFORMIDADE.

Razer (Europe) GmbH declara que este OSVR Hacker Development Kit está conforme com os requisitos essenciais e outras disposições da Directiva 2004/108/EC.

DANSK

ERKLÆRING OM OVERENSSTEMMELSE MED EU-DIREKTIV

Undertegnede Razer (Europe) GmbH erklærer herved, at følgende udstyr OSVR Hacker Development Kit overholder de væsentlige krav og øvrige relevante krav i direktiv 2004/108/EC.

POLSKI

OSWIADCZENIE O ZGODNOSCI Z DYREKTYWA UE

Niniejszym Razer (Europe) GmbH oświadcza, że OSVR Hacker Development Kit jest zgodny z zasadniczymi wymogami oraz pozostałymi stosownymi postanowieniami Dyrektywy 2004/108/EC.

The full Declaration of Conformity can be requested via the following:

Company: Razer (Europe) GmbH

Address: Winterhuder Weg 82, D-22085 Hamburg, Germany

E-mail: compliance@razerzone.com

10. LEGALESE

COPYRIGHT AND INTELLECTUAL PROPERTY INFORMATION

Razer Inc. (“Razer”), its licensors and partners may have copyright, trademarks, trade secrets, patents, patent applications, or other intellectual property rights (whether registered or unregistered) concerning the product in this guide. Furnishing of this guide does not give you a license to any such copyright, trademark, patent or other intellectual property right.

The OSVR Hacker Development Kit (the “Product”) may differ from pictures whether on packaging or otherwise. Razer assumes no responsibility for such differences or for any errors that may appear. Information contained herein is subject to change without notice.

The OSVR Hacker Development Kit is supplied solely to facilitate the creation and development of interactive software applications as well as integration of new hardware. All products created, developed, and integrated using the OSVR Hacker Development Kit are to be used solely with the Virtual Reality Headset.

LIMITED PRODUCT WARRANTY

For the latest and current terms of the Limited Product Warranty, please visit: razerzone.com/warranty.

LIMITATION OF LIABILITY

Razer shall in no event be liable for any lost profits, loss of information or data, special, incidental, indirect, punitive or consequential or incidental damages, arising in any way out of distribution of, sale of, resale of, use of, or inability to use the Product. In no event shall Razer’s liability exceed the retail purchase price of the Product.

COSTS OF PROCUREMENT

For the avoidance of doubt, in no event will Razer be liable for any costs of procurement unless it has been advised of the possibility of such damages, and in no case shall Razer be liable for any costs of procurement liability exceeding the retail purchase price of the Product.

GENERAL

These terms shall be governed by and construed under the laws of the jurisdiction in which the Product was purchased. If any term herein is held to be invalid or unenforceable, then such term (in so far as it is invalid or unenforceable) shall be given no effect and deemed to be excluded without invalidating any of the remaining terms. Razer reserves the right to amend any term at any time without notice.