

Inspiron 15 5000 Gaming Service Manual

Computer Model: Inspiron 15-5577
Regulatory Model: P57F
Regulatory Type: P57F003



Notes, cautions, and warnings



NOTE: A NOTE indicates important information that helps you make better use of your product.



CAUTION: A CAUTION indicates either potential damage to hardware or loss of data and tells you how to avoid the problem.



WARNING: A WARNING indicates a potential for property damage, personal injury, or death.

Copyright © 2017 Dell Inc. or its subsidiaries. All rights reserved. Dell, EMC, and other trademarks are trademarks of Dell Inc. or its subsidiaries. Other trademarks may be trademarks of their respective owners.

2017 - 03

Rev. A00

Contents

Before working inside your computer.....	10
Before you begin	10
Safety instructions.....	10
Recommended tools.....	11
Screw list.....	12
After working inside your computer.....	13
Removing the base cover.....	14
Procedure.....	14
Replacing the base cover.....	16
Procedure.....	16
Removing the battery.....	17
Prerequisites.....	17
Procedure.....	17
Replacing the battery.....	20
Procedure.....	20
Post-requisites.....	20
Removing the memory modules.....	21
Prerequisites.....	21
Procedure.....	21



Replacing the memory modules.....	23
Procedure.....	23
Post-requisites.....	24
Removing the hard drive.....	25
Prerequisites.....	25
Procedure.....	25
Replacing the hard drive.....	28
Procedure.....	28
Post-requisites.....	28
Removing the solid-state drive.....	29
Prerequisites.....	29
Procedure.....	29
Replacing the solid-state drive.....	31
Procedure.....	31
Post-requisites.....	32
Removing the wireless card.....	33
Prerequisites.....	33
Procedure.....	33
Replacing the wireless card.....	35
Procedure.....	35
Post-requisites.....	36
Removing the keyboard.....	37
Prerequisites.....	37
Procedure.....	37



- Replacing the keyboard.....40**
 - Procedure..... 40
 - Post-requisites..... 40
 - Folding the Keyboard Cables..... 40

- Removing the palm-rest assembly..... 43**
 - Prerequisites.....43
 - Procedure.....43

- Replacing the palm-rest assembly.....48**
 - Procedure..... 48
 - Post-requisites..... 48

- Removing the coin-cell battery..... 49**
 - Prerequisites..... 49
 - Procedure..... 49

- Replacing the coin-cell battery..... 51**
 - Procedure..... 51
 - Post-requisites..... 51

- Removing the status-light board..... 52**
 - Prerequisites..... 52
 - Procedure..... 52

- Replacing the status-light board..... 54**
 - Procedure..... 54
 - Post-requisites..... 54

- Removing the fans..... 55**
 - Prerequisites..... 55
 - Procedure..... 55



Replacing the fans.....	58
Procedure.....	58
Post-requisites.....	58
Removing the power-adapter port.....	59
Prerequisites.....	59
Procedure.....	59
Replacing the power-adapter port.....	62
Procedure.....	62
Post-requisites.....	62
Removing the I/O board.....	63
Prerequisites.....	63
Procedure.....	63
Replacing the I/O board.....	65
Procedure.....	65
Post-requisites.....	65
Removing the system board.....	66
Prerequisites.....	66
Procedure.....	67
Replacing the system board.....	70
Procedure.....	70
Post-requisites.....	71
Removing the heat sink.....	72
Prerequisites.....	72
Procedure.....	73



Replacing the heat sink.....	74
Procedure.....	74
Post-requisites.....	74
Removing the speakers.....	76
Prerequisites.....	76
Procedure.....	76
Replacing the speakers.....	78
Procedure.....	78
Post-requisites.....	78
Removing the subwoofer.....	80
Prerequisites.....	80
Procedure.....	80
Replacing the subwoofer.....	82
Procedure.....	82
Post-requisites.....	82
Removing the display assembly.....	84
Prerequisites.....	84
Procedure.....	84
Replacing the display assembly.....	87
Procedure.....	87
Post-requisites.....	87
Removing the display bezel.....	89
Prerequisites.....	89
Procedure.....	89



Replacing the display bezel.....	91
Procedure.....	91
Post-requisites.....	91
Removing the display panel.....	92
Prerequisites.....	92
Procedure.....	92
Replacing the display panel.....	95
Procedure.....	95
Post-requisites.....	95
Removing the camera.....	97
Prerequisites.....	97
Procedure.....	97
Replacing the camera.....	99
Procedure.....	99
Post-requisites.....	99
Removing the display cable.....	100
Prerequisites.....	100
Procedure.....	100
Replacing the display cable.....	102
Procedure.....	102
Post-requisites.....	102
Removing the display hinge and bracket assembly.....	104
Prerequisites.....	104
Procedure.....	104



- Replacing the display hinge and bracket assembly.....106**
 - Procedure..... 106
 - Post-requisites..... 106

- Removing the display back-cover and antenna assembly..... 108**
 - Prerequisites..... 108
 - Procedure..... 109

- Replacing the display back-cover and antenna assembly..... 110**
 - Procedure..... 110
 - Post-requisites..... 110

- Flashing the BIOS..... 111**

- Diagnostics..... 112**

- Getting help and contacting Dell..... 114**
 - Self-help resources..... 114
 - Contacting Dell..... 114





GUID-5D3B1051-9384-409A-8D5B-9B53BD496DE8

Before working inside your computer

 **NOTE:** The images in this document may differ from your computer depending on the configuration you ordered.

GUID-B2521C24-A407-4ABB-8022-6D88B53F0B94

Before you begin







- 1 Save and close all open files and exit all open applications.
- 2 Shut down your computer. Click **Start** →  **Power** → **Shut down**.
 -  **NOTE:** If you are using a different operating system, see the documentation of your operating system for shut-down instructions.
- 3 Disconnect your computer and all attached devices from their electrical outlets.
- 4 Disconnect all attached network devices and peripherals, such as keyboard, mouse, and monitor from your computer.
- 5 Remove any media card and optical disc from your computer, if applicable.
- 6 Close the display and turn the computer over.

GUID-71128823-CE64-4E17-9439-DEE95AF668C4

Safety instructions

Use the following safety guidelines to protect your computer from potential damage and ensure your personal safety.

 **WARNING:** Before working inside your computer, read the safety information that shipped with your computer. For more safety best practices, see the Regulatory Compliance home page at www.dell.com/regulatory_compliance.

-  **WARNING:** Disconnect all power sources before opening the computer cover or panels. After you finish working inside the computer, replace all covers, panels, and screws before connecting to the electrical outlet.
-  **CAUTION:** To avoid damaging the computer, ensure that the work surface is flat and clean.
-  **CAUTION:** To avoid damaging the components and cards, handle them by their edges, and avoid touching pins and contacts.
-  **CAUTION:** You should only perform troubleshooting and repairs as authorized or directed by the Dell technical assistance team. Damage due to servicing that is not authorized by Dell is not covered by your warranty. See the safety instructions that shipped with the product or at www.dell.com/regulatory_compliance.
-  **CAUTION:** Before touching anything inside your computer, ground yourself by touching an unpainted metal surface, such as the metal at the back of the computer. While you work, periodically touch an unpainted metal surface to dissipate static electricity, which could harm internal components.
-  **CAUTION:** When you disconnect a cable, pull on its connector or on its pull tab, not on the cable itself. Some cables have connectors with locking tabs or thumb-screws that you must disengage before disconnecting the cable. When disconnecting cables, keep them evenly aligned to avoid bending any connector pins. When connecting cables, ensure that the ports and connectors are correctly oriented and aligned.
-  **CAUTION:** Press and eject any installed card from the media-card reader.

GUID-074DEC0A-A6E6-4B89-B0DC-0A149C2D2B83

Recommended tools

The procedures in this document may require the following tools:











- Philips screwdriver
- Torx #8 (T8) screwdriver
- Plastic scribe



Screw list

The following table provides the list of screws that are used for securing different components.

Table 1. Screw list

Component	Secured to	Screw type	Quantity	Screw image
Battery	Computer base	M2x5 T8	5	
Hard-drive assembly	Computer base	M2x5	4	
Hard-drive bracket	Hard drive	M3x3	4	
Solid-state drive	Computer base	M2x3	1	
Palm-rest assembly	Computer base	M2x5	2	
Palm-rest assembly	Computer base	M2x5	4	
Wireless card	Computer base	M2x3	1	
Display assembly	Computer base	M2x5	4	
Display hinges	Display back-cover	M2x3	4	
Bracket assembly	Display back-cover	M2x3	2	
Display panel	Display back-cover	M2x3	4	

After working inside your computer



CAUTION: Leaving stray or loose screws inside your computer may severely damage your computer.

- 1 Replace all screws and ensure that no stray screws remain inside your computer.
- 2 Connect any external devices, peripherals, or cables you removed before working on your computer.
- 3 Replace any media cards, discs, or any other parts that you removed before working on your computer.
- 4 Connect your computer and all attached devices to their electrical outlets.
- 5 Turn on your computer.



Removing the base cover

 **WARNING:** Before working inside your computer, read the safety information that shipped with your computer and follow the steps in [Before working inside your computer](#). After working inside your computer, follow the instructions in [After working inside your computer](#). For more safety best practices, see the Regulatory Compliance home page at www.dell.com/regulatory_compliance.

Procedure

- 1 Close the display and turn the computer over.
- 2 Loosen the captive screw that secures the base cover to the computer base.
- 3 Using a plastic scribe, pry the base cover off the computer base.



- 4 Disconnect the battery cable from the system board.



Replacing the base cover



WARNING: Before working inside your computer, read the safety information that shipped with your computer and follow the steps in [Before working inside your computer](#). After working inside your computer, follow the instructions in [After working inside your computer](#). For more safety best practices, see the Regulatory Compliance home page at www.dell.com/regulatory_compliance.

Procedure

- 1 Connect the battery cable to the system board.
- 2 Slide the tabs on the base cover into the slots on the computer base and snap the base cover into place.
- 3 Tighten the captive screw that secures the base cover to the computer base.

GUID-D9015C06-6CEE-42EA-9215-9D0FD7B827D5

Removing the battery



WARNING: Before working inside your computer, read the safety information that shipped with your computer and follow the steps in [Before working inside your computer](#). After working inside your computer, follow the instructions in [After working inside your computer](#). For more safety best practices, see the Regulatory Compliance home page at www.dell.com/regulatory_compliance.

GUID-0C370AA3-39CD-418F-B0C0-9747ADD48E61

Prerequisites

Remove the [base cover](#).

GUID-C687189F-F609-46D6-97DD-E6D51CEBE134

Procedure

- 1 Remove the battery cable from the routing guides on the computer base.



- 2 Remove the five screws (M2x5 T8) that secure the battery to the computer base.

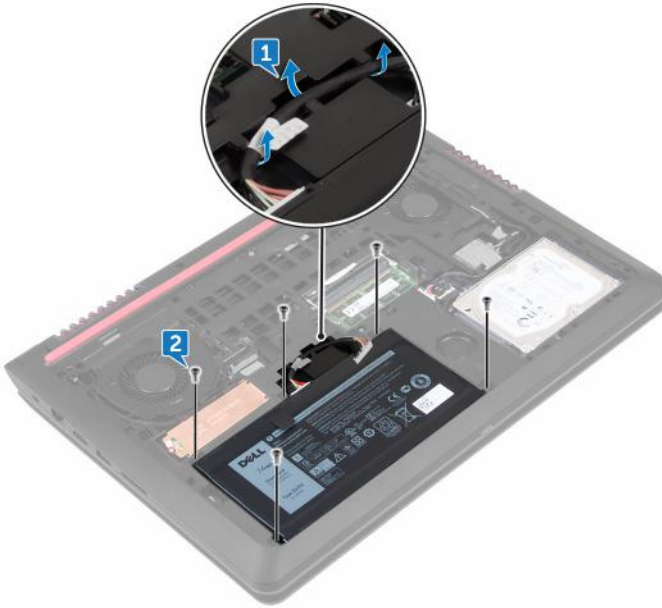

- 3 Using the pull tab, lift the battery, along with its cable, off the computer base.

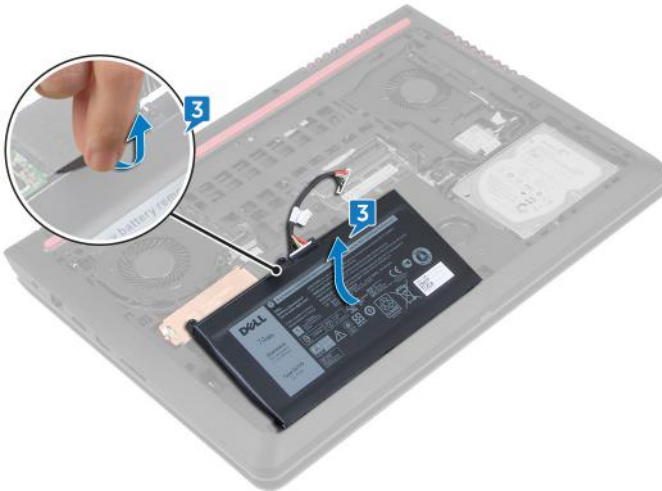

- 4 Turn the computer over, open the display, and press and hold the power button for five seconds to ground the system board.



GUID-E15EE482-44FD-4E71-91FC-899D4B61532E

Replacing the battery



WARNING: Before working inside your computer, read the safety information that shipped with your computer and follow the steps in [Before working inside your computer](#). After working inside your computer, follow the instructions in [After working inside your computer](#). For more safety best practices, see the Regulatory Compliance home page at www.dell.com/regulatory_compliance.

GUID-B6BA1219-85DB-4222-BD97-6ADB162E7DB3

Procedure

- 1 Slide the battery in the slot on the computer base.
- 2 Align the screw holes on the battery with the screw holes on the computer base
- 3 Replace the five screws (M2x5 T8) that secure the battery to the computer base.
- 4 Route the battery cable through the routing guides on the computer base.

GUID-EE31644C-8CF0-4069-89C9-C081096D205E

Post-requisites

Replace the [base cover](#).

GUID-AAC0DC5A-1680-492D-804F-52F812D409C2

Removing the memory modules



WARNING: Before working inside your computer, read the safety information that shipped with your computer and follow the steps in [Before working inside your computer](#). After working inside your computer, follow the instructions in [After working inside your computer](#). For more safety best practices, see the Regulatory Compliance home page at www.dell.com/regulatory_compliance.

GUID-049F47A2-1383-4B8F-A936-163A66D04BA2

Prerequisites

Remove the [base cover](#).

GUID-D2C0013B-8B21-42E2-AE29-C08DA01CB3F2

Procedure

- 1 Use your fingertips to carefully spread apart the securing-clips on each end of the memory-module slot until the memory module pops up.



- 2 Remove the memory module from the memory-module slot.

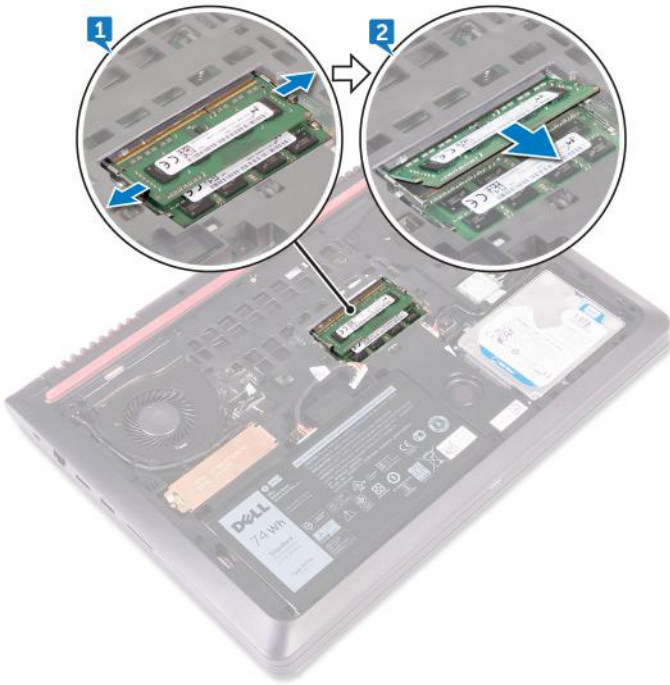

Replacing the memory modules



WARNING: Before working inside your computer, read the safety information that shipped with your computer and follow the steps in [Before working inside your computer](#). After working inside your computer, follow the instructions in [After working inside your computer](#). For more safety best practices, see the Regulatory Compliance home page at www.dell.com/regulatory_compliance.

Procedure

- 1 Align the notch on the memory module with the tab on the memory-module slot and slide it firmly into the slot at an angle.

- 2 Press the memory module down until it clicks into place.

 **NOTE: If you do not hear the click, remove the memory module and reinstall it.**

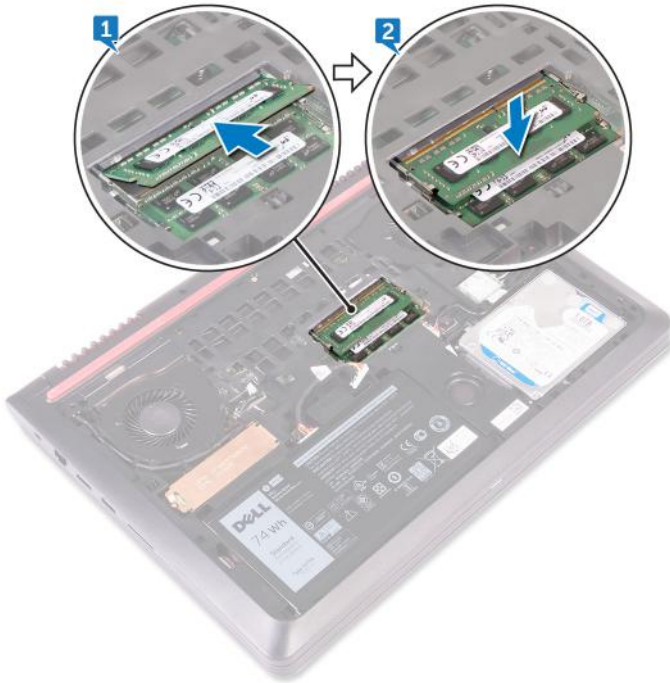

GUID-236C7687-3216-456C-A13C-2F69674BC7B5

Post-requisites

Replace the [base cover](#).

GUID-5DE1E07B-4633-4536-ACBF-4A3067007FE0

Removing the hard drive



WARNING: Before working inside your computer, read the safety information that shipped with your computer and follow the steps in [Before working inside your computer](#). After working inside your computer, follow the instructions in [After working inside your computer](#). For more safety best practices, see the Regulatory Compliance home page at www.dell.com/regulatory_compliance.



CAUTION: Hard drives are fragile. Exercise care when handling the hard drive.



CAUTION: To avoid data loss, do not remove the hard drive while the computer is in sleep or on state.

GUID-CA4CF6BC-6E4B-4911-B0B3-C222B675CE60

Prerequisites

Remove the [base cover](#).

GUID-EC509C56-F296-47E8-A7C3-5E273F1D4F36

Procedure

- 1 Using the pull-tab, disconnect the hard-drive cable from the system board.
- 2 Remove the four screws (M2x5) that secure the hard-drive assembly to the computer base.



- 3 Lift the hard-drive assembly, along with its cable, off the computer base.

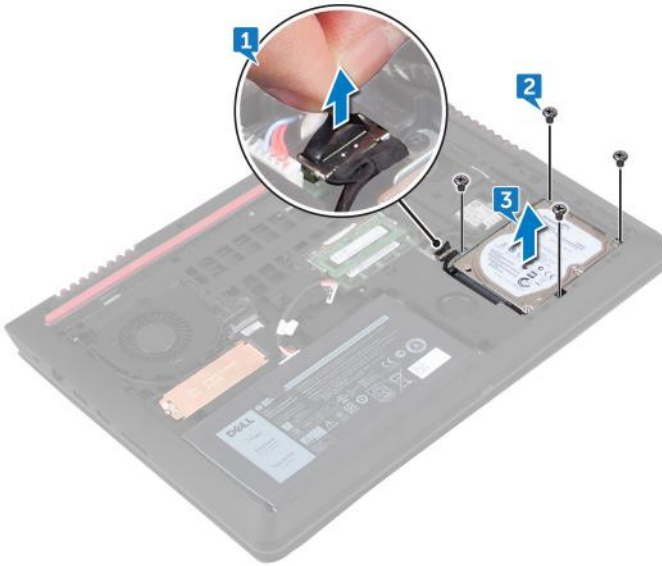

- 4 Disconnect the interposer from the hard-drive assembly.
- 5 Remove the four screws (M3x3) that secure the hard-drive bracket to the hard drive.

6 Remove the hard-drive bracket off the hard drive.



Replacing the hard drive

 **WARNING:** Before working inside your computer, read the safety information that shipped with your computer and follow the steps in [Before working inside your computer](#). After working inside your computer, follow the instructions in [After working inside your computer](#). For more safety best practices, see the Regulatory Compliance home page at www.dell.com/regulatory_compliance.

 **CAUTION:** Hard drives are fragile. Exercise care when handling the hard drive.

Procedure

- 1 Align the screw holes on the hard-drive bracket with the screw holes on the hard drive.
- 2 Replace the four screws (M3x3) that secure the hard-drive bracket to the hard drive.
- 3 Connect the interposer to the hard-drive assembly.
- 4 Align the screw holes on the hard-drive assembly with the screw holes on the computer base.
- 5 Replace the four screws (M2x5) that secure the hard-drive assembly to the computer base.
- 6 Connect the hard-drive cable to the connector on the system board.

Post-requisites

Replace the [base cover](#).

Removing the solid-state drive

 **WARNING:** Before working inside your computer, read the safety information that shipped with your computer and follow the steps in [Before working inside your computer](#). After working inside your computer, follow the instructions in [After working inside your computer](#). For more safety best practices, see the Regulatory Compliance home page at www.dell.com/regulatory_compliance.

 **CAUTION:** Solid-state drives are fragile. Exercise care when handling the solid-state drive.

 **CAUTION:** To avoid data loss, do not remove the solid-state drive while the computer is in sleep or on state.

Prerequisites

Remove the [base cover](#).

Procedure

- 1 Remove the screw (M2x3) that secures the solid-state drive shield and solid-state drive to the computer base.
- 2 Slide and remove the solid-state drive shield from the solid-state drive.



NOTE: Solid-state drive shield is applicable to computers that are shipped with PCIe/NVMe solid-state drive.

3 Slide and remove the solid-state drive from the solid-state drive slot.

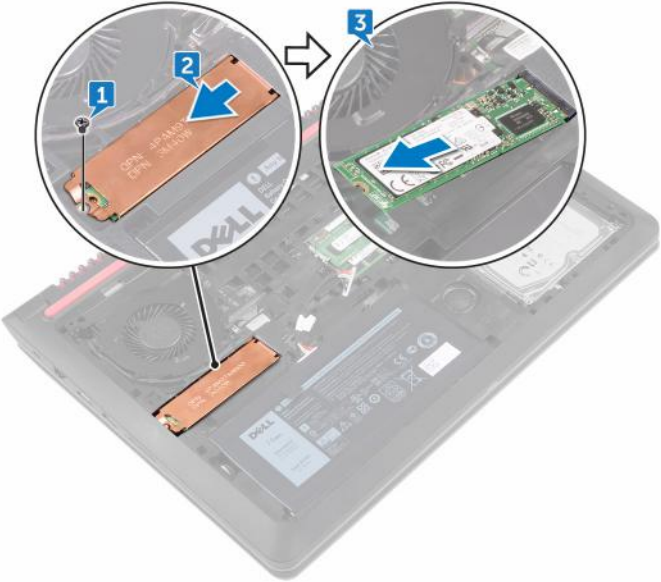

Replacing the solid-state drive

 **WARNING:** Before working inside your computer, read the safety information that shipped with your computer and follow the steps in [Before working inside your computer](#). After working inside your computer, follow the instructions in [After working inside your computer](#). For more safety best practices, see the Regulatory Compliance home page at www.dell.com/regulatory_compliance.

 **CAUTION:** Solid-state drives are fragile. Exercise care when handling the solid-state drive.

Procedure

- 1 Align the notch on the solid-state drive with the tab on the solid-state drive slot and slide the solid-state drive into the solid-state drive slot.
- 2 Press the other end of the solid-state drive and slide the solid-state drive shield on the solid-state drive.
- 3 Align the screw hole on the solid-state drive and solid-state drive shield with the screw hole on the computer base.

- 4 Replace the screw (M2x3) that secures the solid-state drive and solid-state drive shield to the computer base.

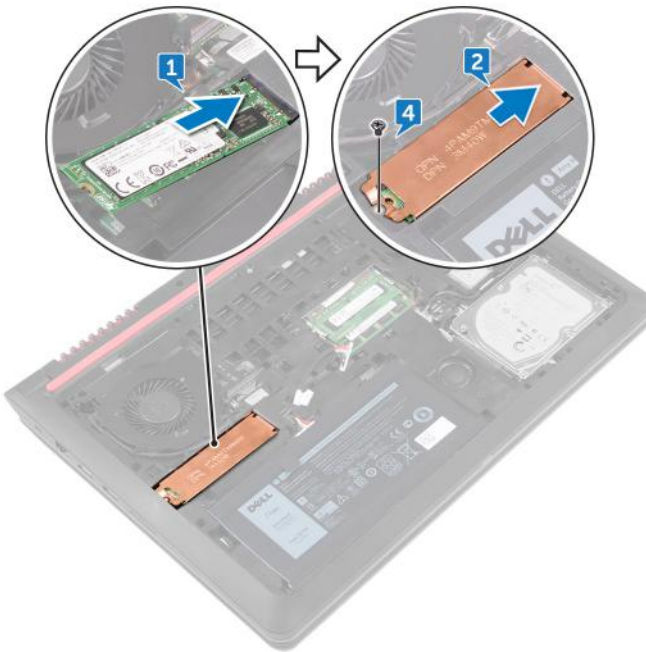

GUID-AE7ECB70-187F-4B55-B064-D848E8B056A4

Post-requisites

Replace the [base cover](#).

GUID-4AF7A7F4-79DC-43F4-A4DF-63362F890FB6

Removing the wireless card



WARNING: Before working inside your computer, read the safety information that shipped with your computer and follow the steps in [Before working inside your computer](#). After working inside your computer, follow the instructions in [After working inside your computer](#). For more safety best practices, see the Regulatory Compliance home page at www.dell.com/regulatory_compliance.

GUID-3C63A198-AEF4-4A5C-8332-3DBE7C0BA47D

Prerequisites

Remove the [base cover](#).

GUID-FAA0A60B-E724-4C05-A633-F119CF394281

Procedure

- 1 Disconnect the antenna cables from the wireless card.
- 2 Remove the screw (M2x3) that secures the wireless card to the chassis.



- 3** Slide and remove the wireless card from the wireless-card slot.

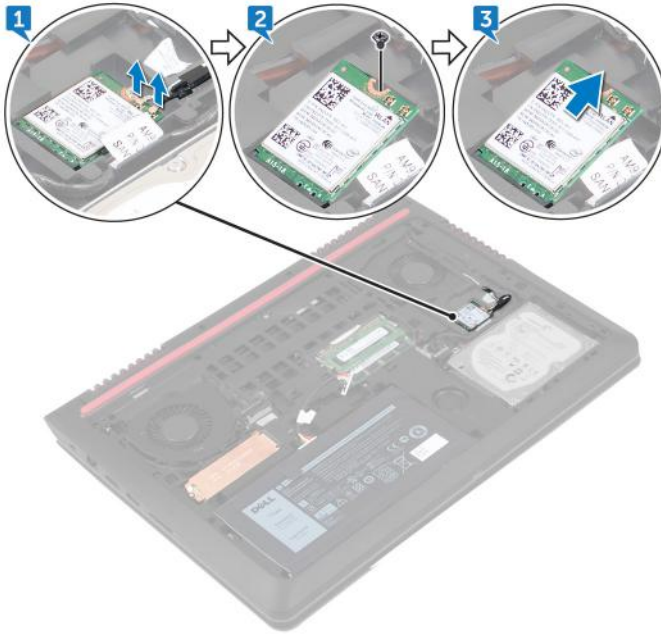

Replacing the wireless card

 **WARNING:** Before working inside your computer, read the safety information that shipped with your computer and follow the steps in [Before working inside your computer](#). After working inside your computer, follow the instructions in [After working inside your computer](#). For more safety best practices, see the Regulatory Compliance home page at www.dell.com/regulatory_compliance.

Procedure

 **CAUTION:** To avoid damage to the wireless card, do not place any cables under it.

- 1 Align the notch on the wireless card with the tab on the wireless-card slot and insert the wireless card at an angle into the wireless-card slot
- 2 Align the screw hole on the wireless card with the screw hole on the chassis.
- 3 Replace the screw (M2x3) that secures the wireless card to chassis.

- 4 Connect the antenna cables to the wireless card.

The following table provides the antenna-cable color scheme for the wireless card supported by your computer.

Table 2. Antenna-cable color scheme

Connectors on the wireless card	Antenna-cable color
Main (white triangle)	White
Auxiliary (black triangle)	Black

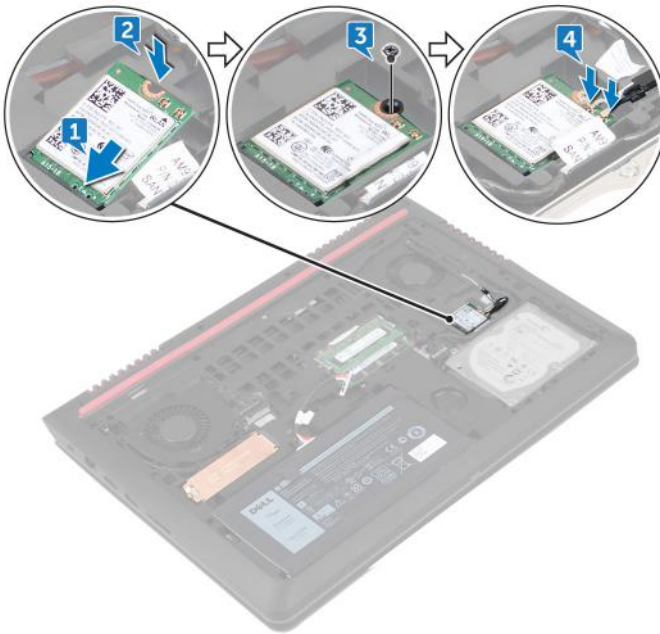

GUID-22E85947-ED90-4695-8CC1-7DFBFAA4C70E

Post-requisites

Replace the [base cover](#).

GUID-5AE964CF-7958-4D31-BBA8-155C933167E8

Removing the keyboard



WARNING: Before working inside your computer, read the safety information that shipped with your computer and follow the steps in [Before working inside your computer](#). After working inside your computer, follow the instructions in [After working inside your computer](#). For more safety best practices, see the Regulatory Compliance home page at www.dell.com/regulatory_compliance.

GUID-111AF520-E9B2-44D2-BC1A-96AD6C9D7A1D

Prerequisites

Remove the [base cover](#).

GUID-31276FD2-4AF6-4FC0-996F-F49B311180E2

Procedure

- 1 Turn the computer over and open the display as far as possible.
- 2 Using a plastic scribe, gently release the tabs that secure the keyboard to the palm-rest assembly.



- Carefully turn the keyboard over and place it on the palm-rest assembly.



- Open the latches and disconnect the keyboard cable and the keyboard-backlight cable from the system board.

- 5 Lift the keyboard, along with the cables, off the palm-rest assembly.

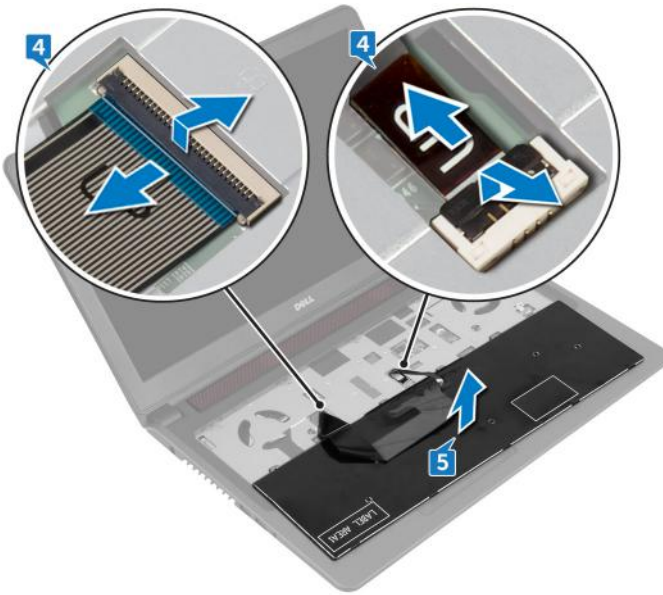

GUID-18204C76-DF75-4DB8-BD6F-EFA74576AAD7

Replacing the keyboard



WARNING: Before working inside your computer, read the safety information that shipped with your computer and follow the steps in [Before working inside your computer](#). After working inside your computer, follow the instructions in [After working inside your computer](#). For more safety best practices, see the Regulatory Compliance home page at www.dell.com/regulatory_compliance.

GUID-08BFA655-500C-4492-8644-3795FA336860

Procedure



NOTE: If you are installing a new keyboard, fold the cables the same way they are folded on the old keyboard. For more information, see "[Folding the Keyboard Cables](#)".

- 1 Slide the keyboard cable and keyboard-backlight cable into their connectors and close the latches to secure the cables.
- 2 Carefully turn the keyboard over, slide the tabs on the keyboard into the slots on the palm-rest assembly, and snap the keyboard into place.
- 3 Close the display and turn the computer over.

GUID-070827EA-D066-403F-A99C-393B3B7E2AB2

Post-requisites

Replace the [base cover](#).

GUID-E0F827D6-EF60-408B-9344-F8DBDCFF264

Folding the Keyboard Cables



CAUTION: Do not apply excess pressure while folding the cables.

The cables on the keyboard are not folded when you receive a replacement keyboard. Follow these instructions to fold the cables on the replacement keyboard the same way they are folded on the old keyboard.

 **NOTE: Keyboard-backlight cable is present only on a backlit-keyboard.**

- 1 Place the keyboard on a flat and clean surface.

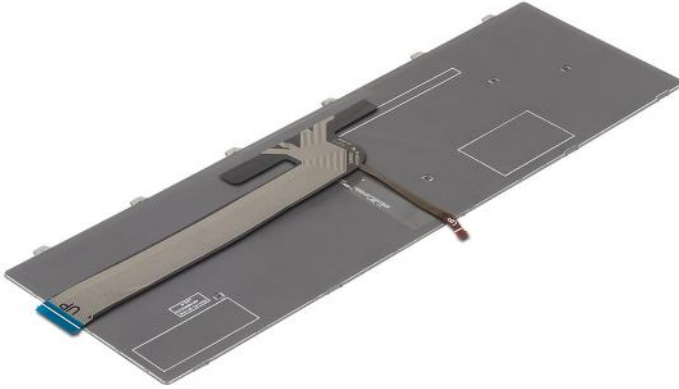

- 2 Gently fold the keyboard-backlight cable till the edge of the keyboard cable as shown in the image.

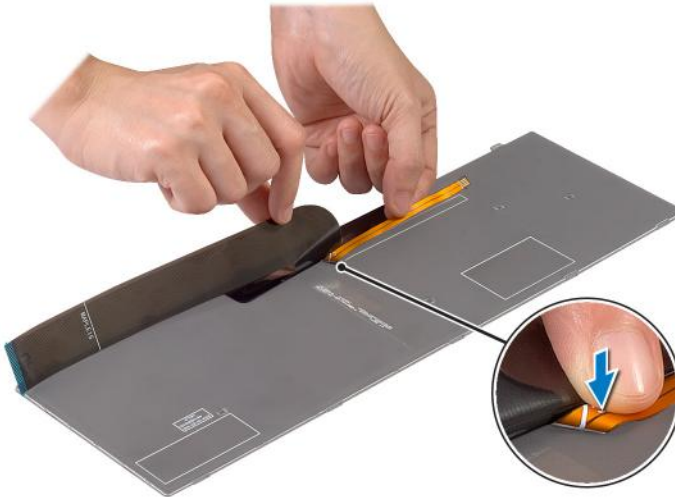

- 3** Gently fold the keyboard cable with the end aligned at the fold line as shown in the image.

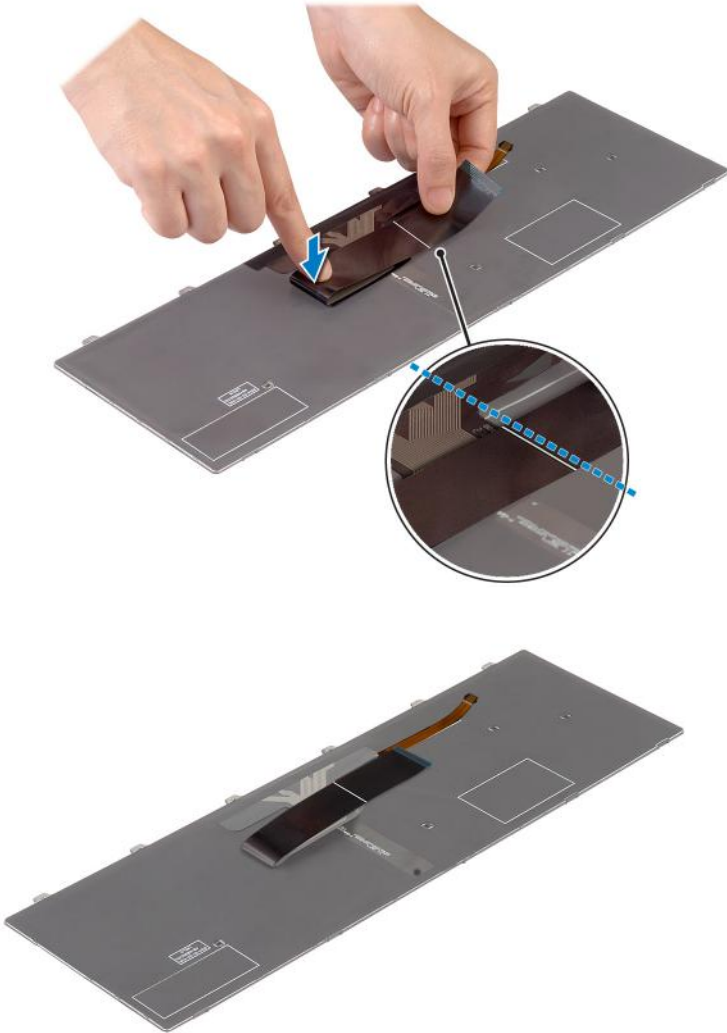

GUID-740BADE7-E98C-41E6-A2C7-D807C0482F9A

Removing the palm-rest assembly



WARNING: Before working inside your computer, read the safety information that shipped with your computer and follow the steps in [Before working inside your computer](#). After working inside your computer, follow the instructions in [After working inside your computer](#). For more safety best practices, see the Regulatory Compliance home page at www.dell.com/regulatory_compliance.

GUID-CBE4B1C7-12A0-4388-BAD2-18B99AE0CFBC

Prerequisites

- 1 Remove the [base cover](#).
- 2 Remove the [battery](#).
- 3 Follow the procedure from step 1 to step 3 in "[Removing the hard drive](#)".
- 4 Remove the [keyboard](#).

GUID-EC73BD66-2A55-4F18-8C10-5F43C74BD492

Procedure

- 1 Open the latch and disconnect the power-button cable from the system board.
- 2 Open the latch and disconnect the touch-pad cable from the system board.



- 3 Remove the two screws (M2x5) that secure the palm-rest assembly to the computer base.

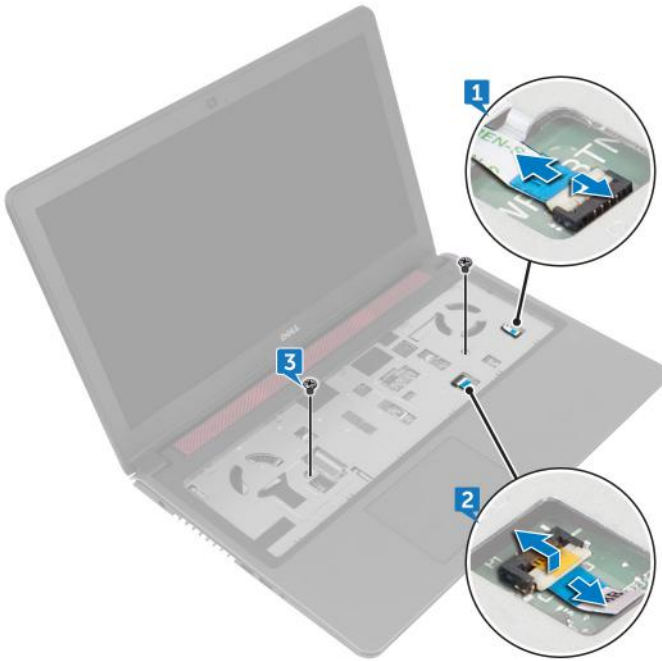

- 4 Close the display and turn the computer over.

- 5 Remove the four screws (M2x5) that secure the palm-rest assembly to the computer base.

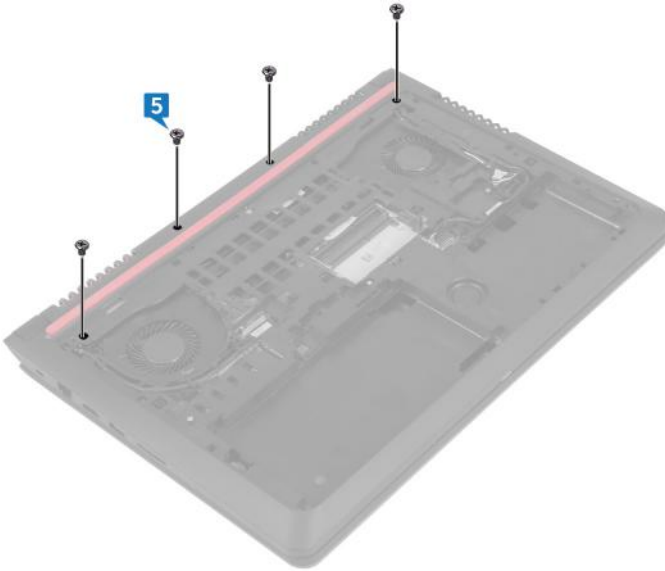

- 6 Lift the computer base and using a plastic scribe, release the tabs on the palm-rest assembly from the slots on the computer base.

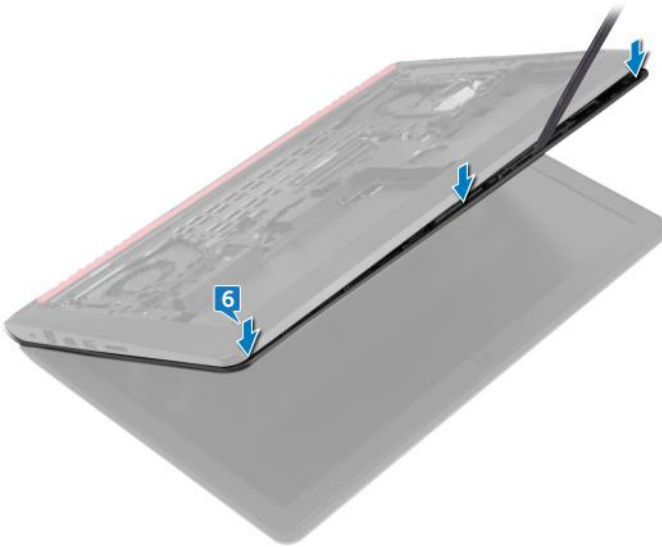

- 7 Turn the computer over and open the display as far as possible.

- 8 Lift the palm-rest assembly off the computer base.

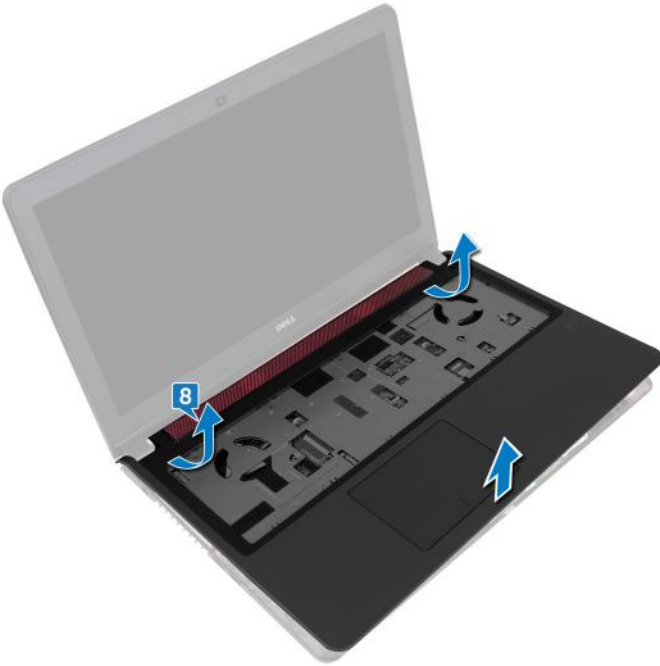

Replacing the palm-rest assembly



WARNING: Before working inside your computer, read the safety information that shipped with your computer and follow the steps in [Before working inside your computer](#). After working inside your computer, follow the instructions in [After working inside your computer](#). For more safety best practices, see the Regulatory Compliance home page at www.dell.com/regulatory_compliance.

Procedure

- 1 Align the screw holes on the palm-rest assembly with the screw holes on the computer base and snap the palm rest into place.
- 2 Replace the two screws (M2x5) that secure the palm-rest assembly to the computer base.
- 3 Slide the touch-pad cable and power-button cable into the connectors and close the latches to secure the cables.
- 4 Close the display and turn the computer over.
- 5 Replace the four screws (M2x5) that secure the palm-rest assembly to the computer base.

Post-requisites

- 1 Replace the [keyboard](#).
- 2 Follow the procedure from step 4 to step 6 in "[Replacing the hard drive](#)".
- 3 Replace the [battery](#).
- 4 Replace the [base cover](#).

Removing the coin-cell battery

 **WARNING:** Before working inside your computer, read the safety information that shipped with your computer and follow the steps in [Before working inside your computer](#). After working inside your computer, follow the instructions in [After working inside your computer](#). For more safety best practices, see the Regulatory Compliance home page at www.dell.com/regulatory_compliance.

 **CAUTION:** Removing the coin-cell battery resets the BIOS setup program's settings to default. It is recommended that you note the BIOS setup program's settings before removing the coin-cell battery.

Prerequisites

- 1 Remove the [base cover](#).
- 2 Remove the [battery](#).
- 3 Follow the procedure from step 1 to step 3 in "[Removing the hard drive](#)".
- 4 Remove the [keyboard](#).
- 5 Remove the [palm-rest assembly](#).

Procedure

- 1 Disconnect the coin-cell battery cable from the system board.



- 2 Using a plastic scribe, gently pry the coin-cell battery out of the battery socket on the computer base.



GUID-5E22F4A0-F01F-4522-8155-BE22A8CA6E5F

Replacing the coin-cell battery



WARNING: Before working inside your computer, read the safety information that shipped with your computer and follow the steps in [Before working inside your computer](#). After working inside your computer, follow the instructions in [After working inside your computer](#). For more safety best practices, see the Regulatory Compliance home page at www.dell.com/regulatory_compliance.

GUID-038582F0-E0F0-456C-BE93-79AB02311711

Procedure

- 1 With the positive-side facing up, snap the coin-cell battery into the battery socket on the computer base.
- 2 Connect the coin-cell battery cable to the system board.

GUID-530FF952-5492-4C67-BD4E-C5D96A9C924E

Post-requisites

- 1 Replace the [palm-rest assembly](#).
- 2 Replace the [keyboard](#).
- 3 Follow the procedure from step 4 to step 6 in "[Replacing the hard drive](#)".
- 4 Replace the [battery](#).
- 5 Replace the [base cover](#).



GUID-D3FE0BE4-9B4F-4CD6-AA62-7E9E26B84AD4

Removing the status-light board



WARNING: Before working inside your computer, read the safety information that shipped with your computer and follow the steps in [Before working inside your computer](#). After working inside your computer, follow the instructions in [After working inside your computer](#). For more safety best practices, see the Regulatory Compliance home page at www.dell.com/regulatory_compliance.

GUID-4E2BE14F-6641-4FA5-8393-1D705E89011F

Prerequisites

- 1 Remove the [base cover](#).
- 2 Remove the [battery](#).
- 3 Follow the procedure from step 1 to step 3 in “[Removing the hard drive](#)”.
- 4 Remove the [keyboard](#).
- 5 Remove the [palm-rest assembly](#).

GUID-049DA82B-8330-42D4-86A6-A12D626829A9

Procedure



NOTE: The status-light board includes an LED indicator for power and battery-status light/hard-drive activity light.

- 1 Open the latch and disconnect the status-light board cable from the status light board.
- 2 Using a plastic scribe, release the status-light board from under the tabs on the computer base.

- 3** Lift the status-light board off the computer base.

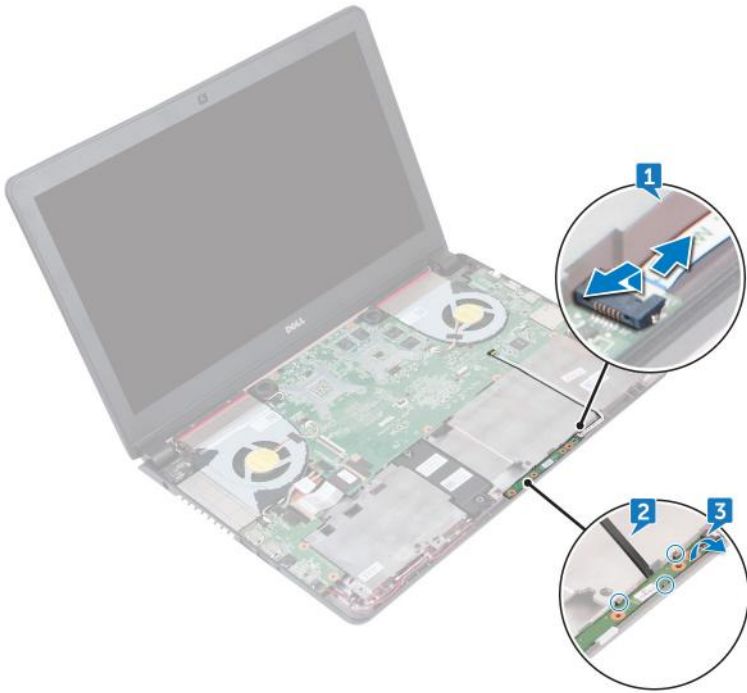

GUID-8EDA8A82-09F4-420D-8DE0-82220E44E1C2

Replacing the status-light board



WARNING: Before working inside your computer, read the safety information that shipped with your computer and follow the steps in [Before working inside your computer](#). After working inside your computer, follow the instructions in [After working inside your computer](#). For more safety best practices, see the Regulatory Compliance home page at www.dell.com/regulatory_compliance.

GUID-F790821E-ACC3-4727-9074-DEAA58C40DBC

Procedure

- 1 Using the alignment posts, place the status-light board in the slot on the computer base.
- 2 Slide the status-light board cable into the connector on the status-light board and close the latch to secure the cable.

GUID-530FF952-5492-4C67-BD4E-C5D96A9C924E

Post-requisites

- 1 Replace the [palm-rest assembly](#).
- 2 Replace the [keyboard](#).
- 3 Follow the procedure from step 4 to step 6 in "[Replacing the hard drive](#)".
- 4 Replace the [battery](#).
- 5 Replace the [base cover](#).



GUID-F98150E9-52A3-4FCD-8420-54A9A2A6DA46

Removing the fans



WARNING: Before working inside your computer, read the safety information that shipped with your computer and follow the steps in [Before working inside your computer](#). After working inside your computer, follow the instructions in [After working inside your computer](#). For more safety best practices, see the Regulatory Compliance home page at www.dell.com/regulatory_compliance.

GUID-4E2BE14F-6641-4FA5-8393-1D705E89011F

Prerequisites

- 1 Remove the [base cover](#).
- 2 Remove the [battery](#).
- 3 Follow the procedure from step 1 to step 3 in “[Removing the hard drive](#)”.
- 4 Remove the [keyboard](#).
- 5 Remove the [palm-rest assembly](#).

GUID-CCBC99E2-1774-4634-A545-6DD394F0BE1F

Procedure

- 1 Disconnect the left-fan cable from the system board.
- 2 Remove the I/O-board power cables from the routing guides on the left fan.



- 3 Lift the left fan, along with its cable, off the computer base.



- 4 Disconnect the right-fan cable from the system board.

- 5 Lift the right fan, along with its cable, off the computer base.

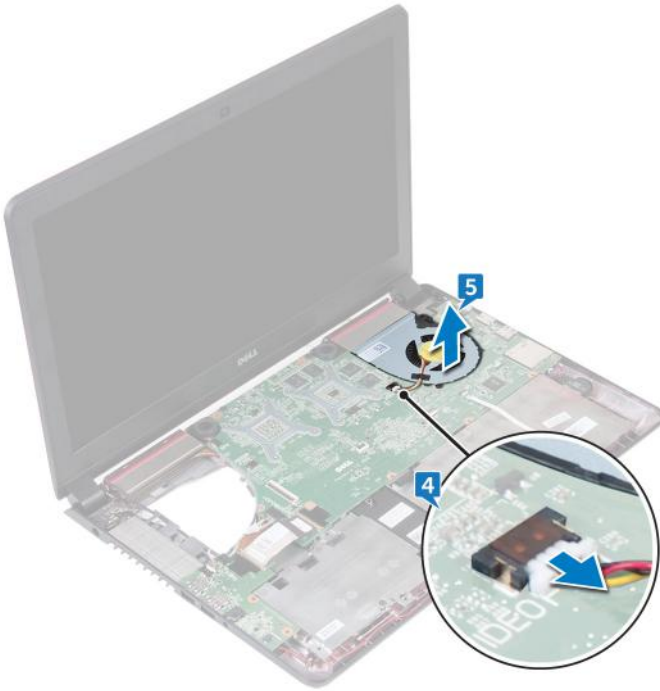

GUID-C3E89978-1994-4C7D-98C9-E51C8651B0A6

Replacing the fans



WARNING: Before working inside your computer, read the safety information that shipped with your computer and follow the steps in [Before working inside your computer](#). After working inside your computer, follow the instructions in [After working inside your computer](#). For more safety best practices, see the Regulatory Compliance home page at www.dell.com/regulatory_compliance.

GUID-595E567B-881C-477D-96B7-5808B2FDA986

Procedure

- 1 Using the alignment posts, place the right fan on the computer base.
- 2 Connect the right-fan cable to the system board.
- 3 Using the alignment posts, place the left fan on the computer base.
- 4 Route the I/O-board power cables through the routing guides on the left fan.
- 5 Connect the left-fan cable to the system board.

GUID-530FF952-5492-4C67-BD4E-C5D96A9C924E

Post-requisites

- 1 Replace the [palm-rest assembly](#).
- 2 Replace the [keyboard](#).
- 3 Follow the procedure from step 4 to step 6 in "[Replacing the hard drive](#)".
- 4 Replace the [battery](#).
- 5 Replace the [base cover](#).

GUID-35D5032D-9652-403C-9A8A-F98FFABA8776

Removing the power-adapter port



WARNING: Before working inside your computer, read the safety information that shipped with your computer and follow the steps in [Before working inside your computer](#). After working inside your computer, follow the instructions in [After working inside your computer](#). For more safety best practices, see the Regulatory Compliance home page at www.dell.com/regulatory_compliance.

GUID-57B854EB-0FFF-49FA-B005-0539FF278025

Prerequisites

- 1 Remove the [base cover](#).
- 2 Remove the [battery](#).
- 3 Follow the procedure from step 1 to step 3 in “[Removing the hard drive](#)”.
- 4 Remove the [keyboard](#).
- 5 Remove the [palm-rest assembly](#).
- 6 Remove the [fans](#).

GUID-85D64419-AC46-4DAD-8CB6-351015410547

Procedure

- 1 Disconnect the power-adapter port cable from the system board.



- 2 Remove the power-adaptor port cable from the routing guides on the computer base and turn the computer over.

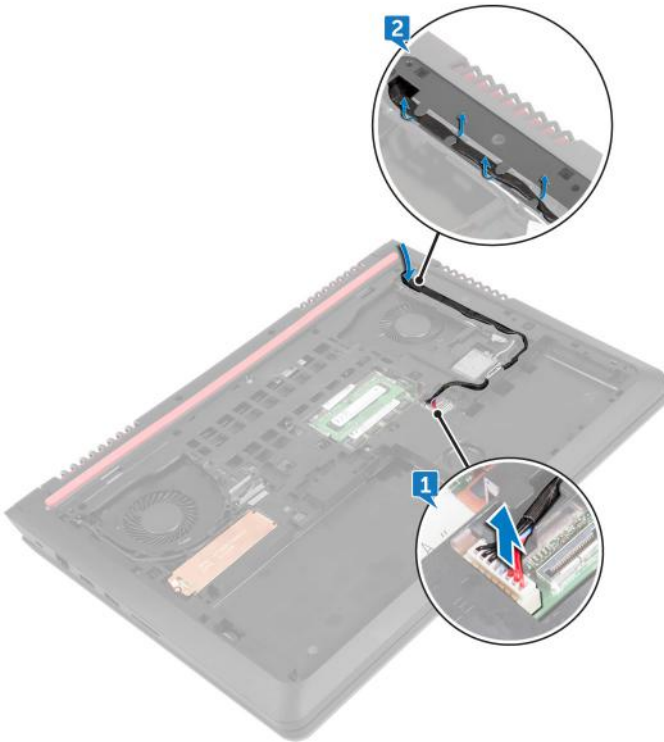

- 3 Remove the cable through the slots on the computer base and lift the power-adapter port along with its cable off the computer base.



GUID-A99140DB-7AF3-4218-B305-532FF94DF51D

Replacing the power-adapter port



WARNING: Before working inside your computer, read the safety information that shipped with your computer and follow the steps in [Before working inside your computer](#). After working inside your computer, follow the instructions in [After working inside your computer](#). For more safety best practices, see the Regulatory Compliance home page at www.dell.com/regulatory_compliance.

GUID-69394734-CD91-4D90-BD23-AD4056766042

Procedure

- 1 Insert the power-adapter port into the slot on the computer base.
- 2 Route the power-adapter port cable through the routing guides on the computer base.
- 3 Connect the power-adapter port cable to the system board.

GUID-D9A17E63-C44D-48D1-90E9-7EABE699EF43

Post-requisites

- 1 Replace the [fans](#).
- 2 Replace the [palm-rest assembly](#).
- 3 Replace the [keyboard](#).
- 4 Follow the procedure from step 4 to step 6 in "[Replacing the hard drive](#)".
- 5 Replace the [battery](#).
- 6 Replace the [base cover](#).

GUID-DC61C8F1-86D0-49DE-B8D8-229750E714D6

Removing the I/O board



WARNING: Before working inside your computer, read the safety information that shipped with your computer and follow the steps in [Before working inside your computer](#). After working inside your computer, follow the instructions in [After working inside your computer](#). For more safety best practices, see the Regulatory Compliance home page at www.dell.com/regulatory_compliance.

GUID-4E2BE14F-6641-4FA5-8393-1D705E89011F

Prerequisites

- 1 Remove the [base cover](#).
- 2 Remove the [battery](#).
- 3 Follow the procedure from step 1 to step 3 in “[Removing the hard drive](#)”.
- 4 Remove the [keyboard](#).
- 5 Remove the [palm-rest assembly](#).

GUID-FC2C2F7E-7427-49C5-BA7E-482D730890E0

Procedure

- 1 Peel off the tape to open the latch and disconnect the I/O-board cable from the I/O board.
- 2 Disconnect the I/O-board power cables from the I/O board.
- 3 Disconnect the subwoofer cable from the I/O board.



- 4 Pull the release tab and lift the I/O board off the computer base.

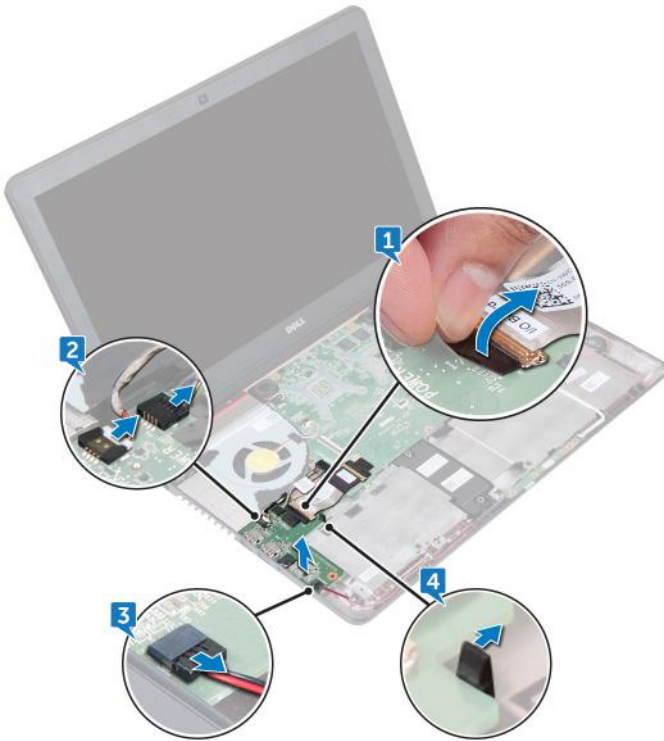

GUID-98F27B1C-9F09-48EC-83D7-FC85C825E6A4

Replacing the I/O board



WARNING: Before working inside your computer, read the safety information that shipped with your computer and follow the steps in [Before working inside your computer](#). After working inside your computer, follow the instructions in [After working inside your computer](#). For more safety best practices, see the Regulatory Compliance home page at www.dell.com/regulatory_compliance.

GUID-C7A35960-9C59-4BE5-B9A2-BF7E65563CC9

Procedure

- 1 Align and place the I/O-board on the computer base.
- 2 Adhere the tape that secures the I/O board cable to the I/O board.
- 3 Slide the I/O-board cable into the connector on the I/O board and close the latch to secure the cable.
- 4 Connect the I/O-board power cables and sub-woofer cable to the I/O board.

GUID-530FF952-5492-4C67-BD4E-C5D96A9C924E

Post-requisites

- 1 Replace the [palm-rest assembly](#).
- 2 Replace the [keyboard](#).
- 3 Follow the procedure from step 4 to step 6 in "[Replacing the hard drive](#)".
- 4 Replace the [battery](#).
- 5 Replace the [base cover](#).



Removing the system board



WARNING: Before working inside your computer, read the safety information that shipped with your computer and follow the steps in [Before working inside your computer](#). After working inside your computer, follow the instructions in [After working inside your computer](#). For more safety best practices, see the Regulatory Compliance home page at www.dell.com/regulatory_compliance.



NOTE: Your computer's Service Tag is stored in the system board. You must enter the Service Tag in the BIOS setup program after you replace the system board.



NOTE: Replacing the system board removes any changes you have made to the BIOS using the BIOS setup program. You must make the appropriate changes again after you replace the system board.



NOTE: Before disconnecting the cables from the system board, note the location of the connectors so that you can reconnect the cables correctly after you replace the system board.

Prerequisites

- 1 Remove the [base cover](#).
- 2 Remove the [battery](#).
- 3 Follow the procedure from step 1 to step 3 in "[Removing the hard drive](#)".
- 4 Remove the [memory modules](#).
- 5 Remove the [solid-state drive](#).
- 6 Remove the [wireless card](#).
- 7 Remove the [keyboard](#).
- 8 Remove the [palm-rest assembly](#).
- 9 Remove the [I/O board](#).
- 10 Remove the [fans](#).

Procedure

- 1 Using the pull-tab, disconnect the display cable from the system board.
- 2 Disconnect the power-adaptor port cable from the system board.



- 3 Turn the computer over and open the display.
- 4 Disconnect the speaker cable from the system board.
- 5 Peel the tape that secures the I/O-board cable to the system board to open the latch and disconnect the I/O-board cable from the system board.
- 6 Disconnect the I/O-board power cable from the system board.
- 7 Open the latch and disconnect the status-light board cable from the system board.

- 8 Disconnect coin-cell battery cable from the system board.

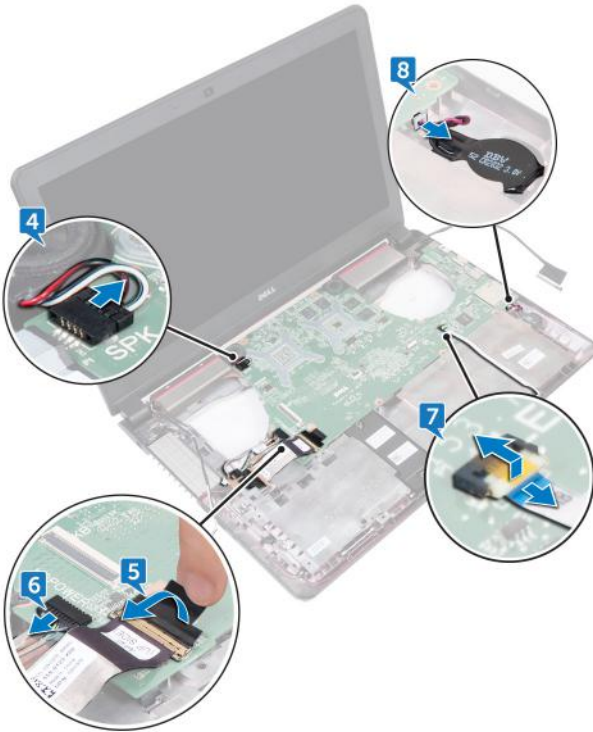

- 9 Lift the system board at an angle, slide and release the ports from the slots on the computer base.

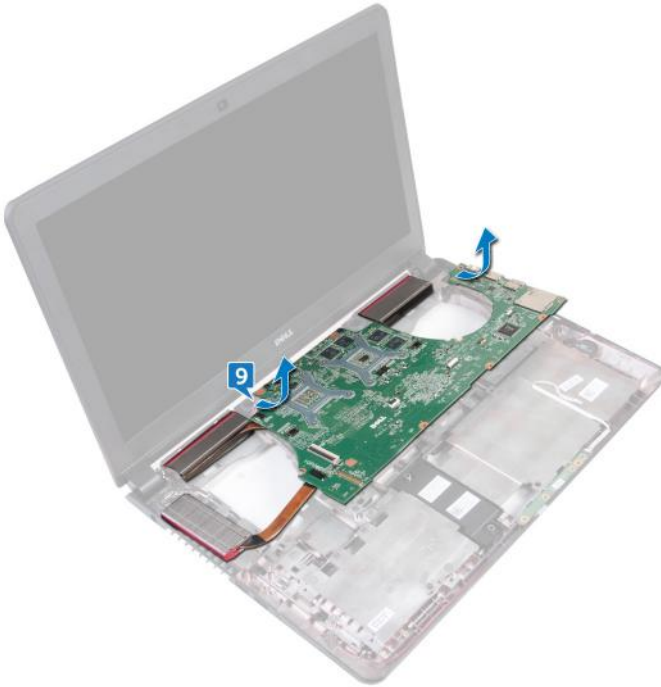

- 10 Remove the [speakers](#).
- 11 Remove the [heat sink](#).



Replacing the system board



WARNING: Before working inside your computer, read the safety information that shipped with your computer and follow the steps in [Before working inside your computer](#). After working inside your computer, follow the instructions in [After working inside your computer](#). For more safety best practices, see the Regulatory Compliance home page at www.dell.com/regulatory_compliance.



NOTE: Your computer's Service Tag is stored in the system board. You must enter the Service Tag in the BIOS setup program after you replace the system board.



NOTE: Replacing the system board removes any changes you have made to the BIOS using the BIOS setup program. You must make the appropriate changes again after you replace the system board.

Procedure



- 1 Replace the [heat sink](#).
- 2 Replace the [speakers](#).
- 3 Slide the ports on the system board into the slots on the computer base and place the system board on the computer base.
- 4 Connect the coin-cell battery cable to the system board.
- 5 Slide the status-light board cable into the connector on the system board and close the latch to secure the cable.
- 6 Connect the speaker cable and I/O-board power cable to the system board.
- 7 Slide and close the latch to secure the cable.
- 8 Adhere the tape that secures the I/O board cable to the system board.
- 9 Close the display and turn the computer over.
- 10 Connect the power-adaptor port cable and display cable to the system board.

Post-requisites

- 1 Replace the [fans](#).
- 2 Replace the [I/O board](#).
- 3 Replace the [palm-rest assembly](#).
- 4 Replace the [keyboard](#).
- 5 Replace the [wireless card](#).
- 6 Replace the [solid-state drive](#).
- 7 Replace the [memory modules](#).
- 8 Follow the procedure from step 4 to step 6 in "[Replacing the hard drive](#)".
- 9 Replace the [battery](#).
- 10 Replace the [base cover](#).



Removing the heat sink

-  **WARNING:** Before working inside your computer, read the safety information that shipped with your computer and follow the steps in [Before working inside your computer](#). After working inside your computer, follow the instructions in [After working inside your computer](#). For more safety best practices, see the Regulatory Compliance home page at www.dell.com/regulatory_compliance.
-  **WARNING:** The heat sink may become hot during normal operation. Allow sufficient time for the heat sink to cool before you touch it.
-  **CAUTION:** For maximum cooling of the processor, do not touch the heat transfer areas on the heat sink. The oils in your skin can reduce the heat transfer capability of the thermal grease.

Prerequisites

- 1 Remove the [base cover](#).
- 2 Remove the [battery](#).
- 3 Follow the procedure from step 1 to step 3 in "[Removing the hard drive](#)".
- 4 Remove the [memory modules](#).
- 5 Remove the [solid-state drive](#).
- 6 Remove the [wireless card](#).
- 7 Remove the [keyboard](#).
- 8 Remove the [palm-rest assembly](#).
- 9 Remove the [I/O board](#).
- 10 Remove the [fans](#).
- 11 Follow the procedure from step 1 to step 10 in "[Removing the system board](#)".



Procedure

 **NOTE:** The appearance of the heat sink on your computer may differ from the image shown in this chapter.

- 1 Place the system board on a clean and flat surface.
- 2 In sequential order (indicated on the heat-sink), loosen the captive screws that secure the heat sink to the system board.
- 3 Lift the heat sink off the system board.

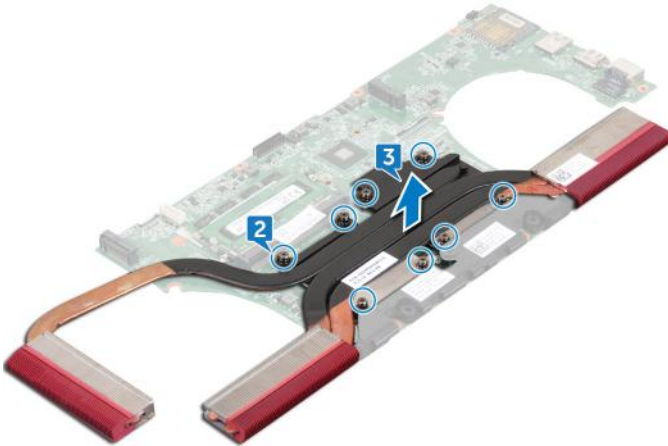

Replacing the heat sink

 **WARNING:** Before working inside your computer, read the safety information that shipped with your computer and follow the steps in [Before working inside your computer](#). After working inside your computer, follow the instructions in [After working inside your computer](#). For more safety best practices, see the Regulatory Compliance home page at www.dell.com/regulatory_compliance.

 **CAUTION:** Incorrect alignment of the heat sink can damage the system board and processor.

 **NOTE:** The original thermal grease can be reused if the original system board and heat sink are reinstalled together. If either the system board or the heat sink is replaced, use the thermal pad provided in the kit to ensure that thermal conductivity is achieved.

Procedure

- 1 Align the screw holes on the heat sink with the screw holes on the system board.
- 2 In sequential order (indicated on the heat-sink), tighten the captive screws that secure the heat sink to the system board.

Post-requisites

- 1 Follow the procedure from step 2 to step 12 in "[Replacing the system board](#)".
- 2 Replace the [fans](#).
- 3 Replace the [I/O board](#).
- 4 Replace the [palm-rest assembly](#).
- 5 Replace the [keyboard](#).
- 6 Replace the [wireless card](#).
- 7 Replace the [solid-state drive](#).

- 8** Replace the [memory modules](#).
- 9** Follow the procedure from step 4 to step 6 in "[Replacing the hard drive](#)".
- 10** Replace the [battery](#).
- 11** Replace the [base cover](#).



Removing the speakers



WARNING: Before working inside your computer, read the safety information that shipped with your computer and follow the steps in [Before working inside your computer](#). After working inside your computer, follow the instructions in [After working inside your computer](#). For more safety best practices, see the Regulatory Compliance home page at www.dell.com/regulatory_compliance.

Prerequisites

- 1 Remove the [base cover](#).
- 2 Remove the [battery](#).
- 3 Follow the procedure from step 1 to step 3 in “[Removing the hard drive](#)”.
- 4 Remove the [memory modules](#).
- 5 Remove the [solid-state drive](#).
- 6 Remove the [wireless card](#).
- 7 Remove the [keyboard](#).
- 8 Remove the [palm-rest assembly](#).
- 9 Remove the [I/O board](#).
- 10 Remove the [fans](#).
- 11 Follow the procedure from step 1 to step 9 in “[Removing the system board](#)”.

Procedure

- 1 Note the position of the rubber grommets and release the rubber grommets from the slots on the system board.

- 2 Slide the speaker off the system board.

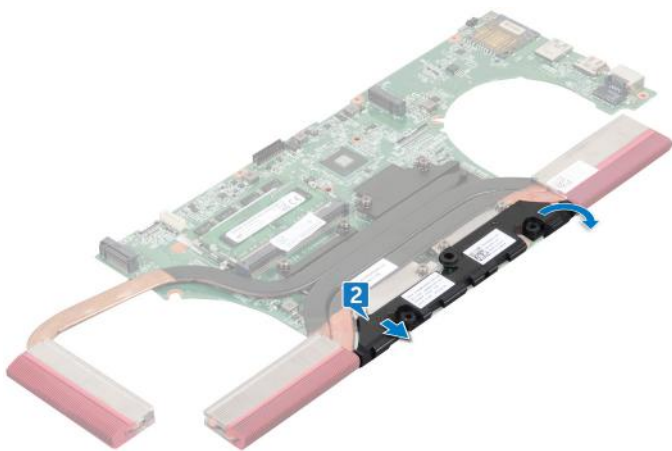

GUID-40DC76F7-B3EC-450A-848E-632D68C352E2

Replacing the speakers



WARNING: Before working inside your computer, read the safety information that shipped with your computer and follow the steps in [Before working inside your computer](#). After working inside your computer, follow the instructions in [After working inside your computer](#). For more safety best practices, see the Regulatory Compliance home page at www.dell.com/regulatory_compliance.

GUID-A231D39F-9132-4613-8D22-3BA540C7830A

Procedure



NOTE: The rubber grommets may get pushed out while replacing the speaker. Ensure that the rubber grommets are in their position after placing the speaker on the system board.

- 1 Using the alignment posts, align and place the speaker on the system board.
- 2 Replace the rubber grommets if they are pushed up while replacing the speaker.

GUID-35A6ECFC-8F40-4EBE-809C-CD3C09A05D89

Post-requisites

- 1 Follow the procedure from step 3 to step 12 in "[Replacing the system board](#)".
- 2 Replace the [fans](#).
- 3 Replace the [I/O board](#).
- 4 Follow the procedure from step 2 to step 6 in "[Replacing the palm-rest assembly](#)".
- 5 Replace the [keyboard](#).
- 6 Replace the [wireless card](#).
- 7 Replace the [solid-state drive](#).
- 8 Replace the [memory modules](#).
- 9 Follow the procedure from step 4 to step 6 in "[Replacing the hard drive](#)".

- 10 Replace the [battery](#).
- 11 Replace the [base cover](#).



GUID-CCE0D2B8-1FAA-48F5-9D85-1746B662EC00

Removing the subwoofer



WARNING: Before working inside your computer, read the safety information that shipped with your computer and follow the steps in [Before working inside your computer](#). After working inside your computer, follow the instructions in [After working inside your computer](#). For more safety best practices, see the Regulatory Compliance home page at www.dell.com/regulatory_compliance.

GUID-57DB760A-2F55-4195-A39D-F4612B8A0C67

Prerequisites

- 1 Remove the [base cover](#).
- 2 Remove the [battery](#).
- 3 Follow the procedure from step 1 to step 3 in “[Removing the hard drive](#)”.
- 4 Remove the [memory modules](#).
- 5 Remove the [solid-state drive](#).
- 6 Remove the [wireless card](#).
- 7 Remove the [keyboard](#).
- 8 Remove the [palm-rest assembly](#).
- 9 Remove the [I/O board](#).
- 10 Remove the [fans](#).
- 11 Follow the procedure from step 1 to step 9 in “[Removing the system board](#)”.

GUID-E25B928F-3006-4BCB-A9E0-1EB3A97E3998

Procedure

- 1 Note the subwoofer cable routing and remove it from the routing guides on the computer base.
- 2 Note the position of the rubber grommets before lifting the subwoofer.



- 3 Lift the subwoofer off the computer base.



GUID-843C6FE2-25D0-48C6-8EB2-9829A89CC1C8

Replacing the subwoofer



WARNING: Before working inside your computer, read the safety information that shipped with your computer and follow the steps in [Before working inside your computer](#). After working inside your computer, follow the instructions in [After working inside your computer](#). For more safety best practices, see the Regulatory Compliance home page at www.dell.com/regulatory_compliance.

GUID-690FE132-660D-4D0B-9C1B-0C0FA0BEA347

Procedure



NOTE: The rubber grommets may get pushed out while replacing the subwoofer. Ensure that the rubber grommets are in their position after placing the subwoofer on the computer base.

- 1 Using the alignment posts, align and place the subwoofer on the computer base.
- 2 Route the subwoofer cable through the routing guides on the computer base.
- 3 Replace the rubber grommets if they are pushed up while replacing the subwoofers.

GUID-40A7CF05-B2F6-46AF-8994-9D9AA0A21ADE

Post-requisites

- 1 Follow the procedure from step 3 to step 8 in "[Replacing the system board](#)".
- 2 Replace the [fans](#).
- 3 Replace the [I/O board](#).
- 4 Replace the [palm-rest assembly](#).
- 5 Replace the [keyboard](#).
- 6 Replace the [wireless card](#).
- 7 Replace the [solid-state drive](#).
- 8 Replace the [memory modules](#).

- 9 Follow the procedure from step 4 to step 6 in "[Replacing the hard drive](#)".
- 10 Replace the [battery](#).
- 11 Replace the [base cover](#).



GUID-AB1F153B-621B-42FC-89BE-0E1105FF1786

Removing the display assembly



WARNING: Before working inside your computer, read the safety information that shipped with your computer and follow the steps in [Before working inside your computer](#). After working inside your computer, follow the instructions in [After working inside your computer](#). For more safety best practices, see the Regulatory Compliance home page at www.dell.com/regulatory_compliance.

GUID-B5230F2E-487B-4214-A52B-237499DD89AF

Prerequisites

- 1 Remove the [base cover](#).
- 2 Remove the [battery](#).
- 3 Follow the procedure from step 1 to step 3 in “[Removing the hard drive](#)”.
- 4 Remove the [keyboard](#)
- 5 Remove the [palm-rest assembly](#).
- 6 Remove the [fans](#).

GUID-0298D5D0-CBE7-4691-AC0D-95968070FA30

Procedure

- 1 Close the display and turn the computer over.
- 2 Using the pull tab, disconnect the display cable from the system board.
- 3 Note the display-cable routing and remove the cable from the routing guides on the computer base.
- 4 Disconnect the antenna cables from the wireless card.
- 5 Note the antenna-cable routing and remove the antenna cables from the routing guides on the computer base.



- 6 Slide the display cable and antenna cables through the slots on the computer base.

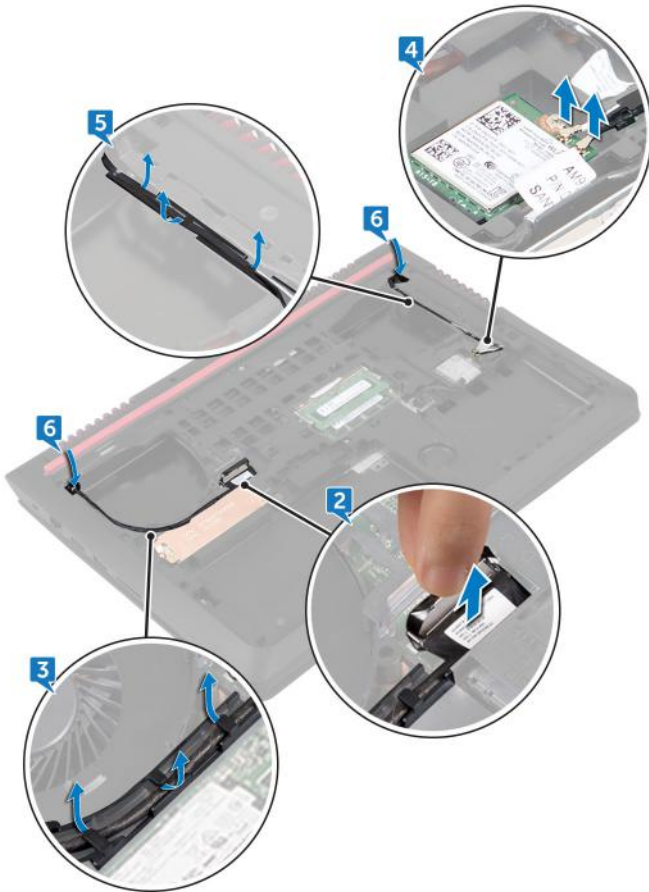

- 7 Remove the four screws (M2x5) that secure the display assembly to the computer base.

- 8 Lift the display assembly off the computer base.

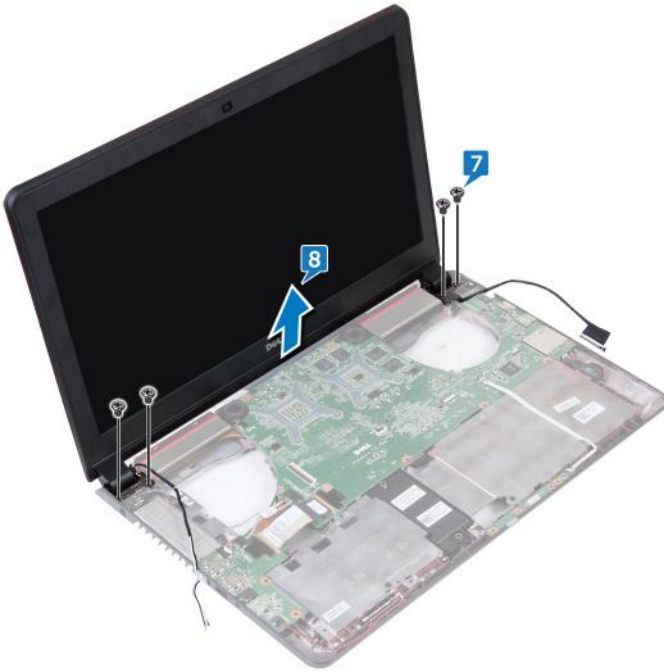

GUID-2DF70EB1-9D26-4051-8B7C-FB14A89925D8

Replacing the display assembly



WARNING: Before working inside your computer, read the safety information that shipped with your computer and follow the steps in [Before working inside your computer](#). After working inside your computer, follow the instructions in [After working inside your computer](#). For more safety best practices, see the Regulatory Compliance home page at www.dell.com/regulatory_compliance.

GUID-20513DC8-46A2-43D0-9037-C0681DDE3299

Procedure

- 1 Align the screw holes on the display assembly with the screw holes on the computer base.
- 2 Replace the four screws (M2x5) that secure the display assembly to the computer base.
- 3 Slide the display cable and antenna cables through the slot on the computer base.
- 4 Close the display and turn the computer over.
- 5 Route the display cable and antenna cables through the routing guides on the computer base.
- 6 Connect the antenna cables to the wireless card.
- 7 Connect the display cable to the system board.
- 8 Close the display and turn the computer over.

GUID-54B4E1CC-911F-4017-B455-13135928F7F6

Post-requisites

- 1 Replace the [fans](#).
- 2 Replace the [palm-rest assembly](#).
- 3 Replace the [keyboard](#).
- 4 Follow the procedure from step 4 to step 6 in "[Replacing the hard drive](#)".



- 5 Replace the [battery](#).
- 6 Replace the [base cover](#).



GUID-5C27B5F7-0EC4-42CD-AB68-CFC88E655D56

Removing the display bezel



WARNING: Before working inside your computer, read the safety information that shipped with your computer and follow the steps in [Before working inside your computer](#). After working inside your computer, follow the instructions in [After working inside your computer](#). For more safety best practices, see the Regulatory Compliance home page at www.dell.com/regulatory_compliance.

GUID-F47EE1A7-D628-4A62-BC98-CF367FD14FE1

Prerequisites



NOTE: These instructions are applicable only for laptops with a non-touch screen display.

- 1 Remove the [base cover](#).
- 2 Remove the [battery](#).
- 3 Follow the procedure from step 1 to step 3 in "[Removing the hard drive](#)".
- 4 Remove the [keyboard](#)
- 5 Remove the [palm-rest assembly](#).
- 6 Remove the [fans](#).
- 7 Remove the [display assembly](#).

GUID-959226BA-FFEF-4B7C-A965-71F8989DCF91

Procedure

- 1 Using your fingertips, gently pry up the outside edges of the display bezel.



- 2 Lift the display bezel off the display assembly.



GUID-619F529E-294B-4F0D-BB9D-9B71EB448811

Replacing the display bezel



WARNING: Before working inside your computer, read the safety information that shipped with your computer and follow the steps in [Before working inside your computer](#). After working inside your computer, follow the instructions in [After working inside your computer](#). For more safety best practices, see the Regulatory Compliance home page at www.dell.com/regulatory_compliance.

GUID-A78695C2-DF5F-471D-8C95-AC5B01ABBB7D

Procedure

Align the display bezel with the display back-cover, and gently snap the display bezel into place.

GUID-575A9C78-B49D-4A7F-8BDA-43761571EBE8

Post-requisites

- 1 Replace the [display assembly](#).
- 2 Replace the [fans](#).
- 3 Replace the [palm-rest assembly](#).
- 4 Replace the [keyboard](#).
- 5 Follow the procedure from step 4 to step 6 in "[Replacing the hard drive](#)".
- 6 Replace the [battery](#).
- 7 Replace the [base cover](#).



GUID-7D2CEA1B-1FC0-4606-86EB-F51C5DFB6E52

Removing the display panel



WARNING: Before working inside your computer, read the safety information that shipped with your computer and follow the steps in [Before working inside your computer](#). After working inside your computer, follow the instructions in [After working inside your computer](#). For more safety best practices, see the Regulatory Compliance home page at www.dell.com/regulatory_compliance.

GUID-1B921F65-013D-4B22-AF4D-6E0688BE2C02

Prerequisites



NOTE: These instructions are applicable only for laptops with a non-touch screen display.

- 1 Remove the [base cover](#).
- 2 Remove the [battery](#).
- 3 Follow the procedure from step 1 to step 3 in "[Removing the hard drive](#)".
- 4 Remove the [keyboard](#)
- 5 Remove the [palm-rest assembly](#).
- 6 Remove the [fans](#).
- 7 Remove the [display assembly](#).
- 8 Remove the [display bezel](#).

GUID-83D93423-9B2E-4DD4-B799-3688697091A5

Procedure

- 1 Remove the four screws (M2x3) that secure the display panel to the display back-cover and antenna assembly.

-
- 2 Gently lift the display panel and turn it over.

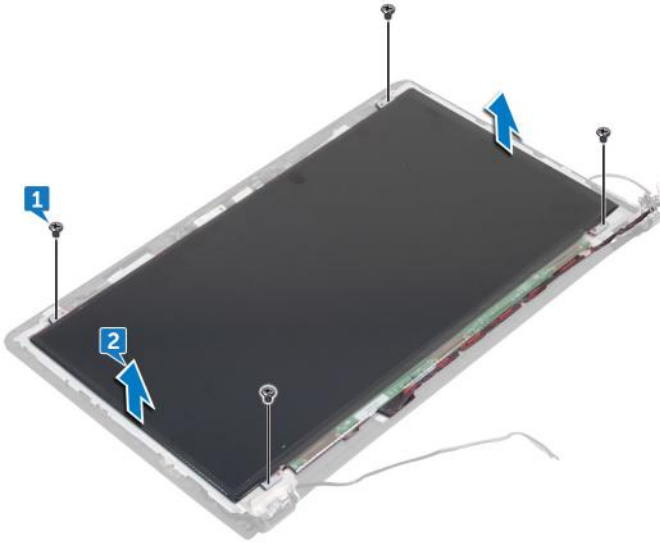

-
-
- 3 Peel off the tape that secures the display cable to the display panel.
- 4 Open the latch and disconnect the display cable from the display panel.

- 5 Lift the display panel off the display back-cover and antenna assembly.

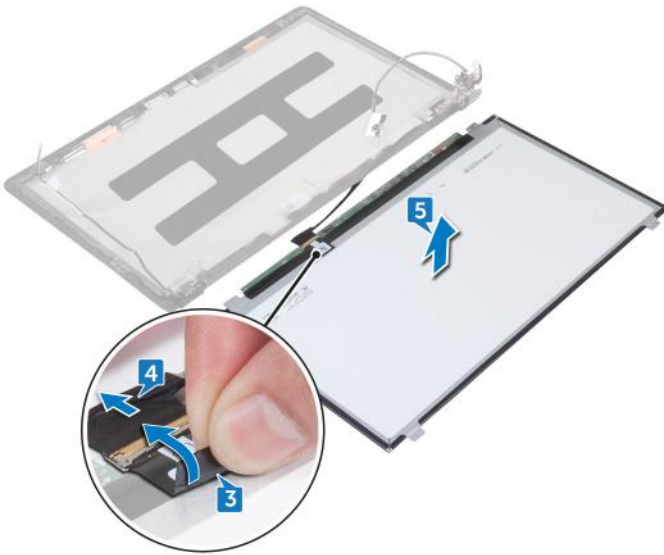

GUID-6FD32244-34F4-4843-983D-B6C14903EFC9

Replacing the display panel



WARNING: Before working inside your computer, read the safety information that shipped with your computer and follow the steps in [Before working inside your computer](#). After working inside your computer, follow the instructions in [After working inside your computer](#). For more safety best practices, see the Regulatory Compliance home page at www.dell.com/regulatory_compliance.

GUID-31CC13B0-7DE7-4072-BF45-2E61E056782E

Procedure

- 1 Slide the display cable into the connector on the display panel and close the latch to secure the cable.
- 2 Adhere the tape that secures the display cable to the display panel.
- 3 Turn the display panel over and gently place it on the display back-cover and antenna assembly.
- 4 Align the screw holes on the display panel with the screw holes on the display back-cover and antenna assembly.
- 5 Replace the four screws (M2x3) that secure the display panel to the display back-cover and antenna assembly.

GUID-263A4E5D-1495-4A26-9E4C-8DB8D8F1F7DB

Post-requisites

- 1 Replace the [display bezel](#).
- 2 Replace the [display assembly](#).
- 3 Replace the [fans](#).
- 4 Replace the [palm-rest assembly](#).
- 5 Replace the [keyboard](#).
- 6 Follow the procedure from step 4 to step 6 in "[Replacing the hard drive](#)".
- 7 Replace the [battery](#).



8 Replace the [base cover](#).



GUID-1FB16E7C-AF0C-4FA0-8736-EAD91D8969A8

Removing the camera



WARNING: Before working inside your computer, read the safety information that shipped with your computer and follow the steps in [Before working inside your computer](#). After working inside your computer, follow the instructions in [After working inside your computer](#). For more safety best practices, see the Regulatory Compliance home page at www.dell.com/regulatory_compliance.

GUID-A81DE201-ECFF-4FB3-97C7-410B28BA9C0E

Prerequisites



NOTE: These instructions are applicable only for laptops with a non-touch screen display.

- 1 Remove the [base cover](#).
- 2 Remove the [battery](#).
- 3 Follow the procedure from step 1 to step 3 in "[Removing the hard drive](#)".
- 4 Remove the [keyboard](#)
- 5 Remove the [palm-rest assembly](#).
- 6 Remove the [fans](#).
- 7 Remove the [display assembly](#).
- 8 Remove the [display bezel](#).
- 9 Remove the [display panel](#).

GUID-243E2B4C-14FA-4B02-8D46-1F0A8F742DB1

Procedure

- 1 Using a plastic scribe, gently pry the camera from the display back-cover and antenna assembly.
- 2 Turn the camera over and peel off the tape that secures the camera cable to the camera.



- 3** Disconnect the camera cable from the camera.

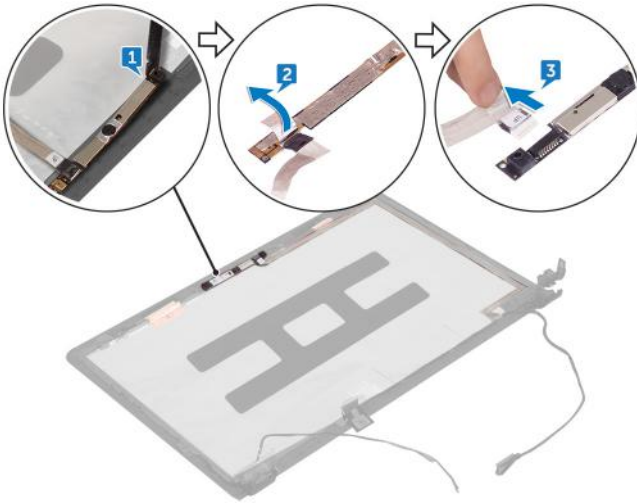

GUID-690FF12D-2581-4326-8270-C4B813388FD3

Replacing the camera



WARNING: Before working inside your computer, read the safety information that shipped with your computer and follow the steps in [Before working inside your computer](#). After working inside your computer, follow the instructions in [After working inside your computer](#). For more safety best practices, see the Regulatory Compliance home page at www.dell.com/regulatory_compliance.

GUID-8D6DFB3B-3EB9-43F2-AAD2-077C5B8F068C

Procedure

- 1 Connect the camera cable to the camera.
- 2 Adhere the tape that secures the camera cable to the camera.
- 3 Align the camera to the alignment posts on the display back-cover and antenna assembly and snap the camera in place.

GUID-F07275DD-636B-49AF-8D70-71F228E061EA

Post-requisites

- 1 Replace the [display panel](#).
- 2 Replace the [display bezel](#).
- 3 Replace the [display assembly](#).
- 4 Replace the [fans](#).
- 5 Replace the [palm-rest assembly](#).
- 6 Replace the [keyboard](#).
- 7 Follow the procedure from step 4 to step 6 in "[Replacing the hard drive](#)".
- 8 Replace the [battery](#).
- 9 Replace the [base cover](#).



GUID-166DA787-661F-4E60-8975-5E84EDB0868D

Removing the display cable



WARNING: Before working inside your computer, read the safety information that shipped with your computer and follow the steps in [Before working inside your computer](#). After working inside your computer, follow the instructions in [After working inside your computer](#). For more safety best practices, see the Regulatory Compliance home page at www.dell.com/regulatory_compliance.

GUID-17F08195-0F73-43BA-AE47-5A94D212A368

Prerequisites



NOTE: These instructions are applicable only for laptops with a non-touch screen display.

- 1 Remove the [base cover](#).
- 2 Remove the [battery](#).
- 3 Follow the procedure from step 1 to step 3 in "[Removing the hard drive](#)".
- 4 Remove the [keyboard](#)
- 5 Remove the [palm-rest assembly](#).
- 6 Remove the [fans](#).
- 7 Remove the [display assembly](#).
- 8 Remove the [display bezel](#).
- 9 Remove the [display panel](#).
- 10 Remove the [camera](#).

GUID-422284EA-6D65-40C2-8EB0-9325C58CD193

Procedure

- 1 Peel off the display cable from the display back-cover and antenna assembly.
- 2 Remove the display cable from the routing guides on the display hinge and bracket assembly



- 3 Remove the display cable from the routing guides on the display back-cover and antenna assembly.
- 4 Lift the display cable off the display back-cover and antenna assembly.

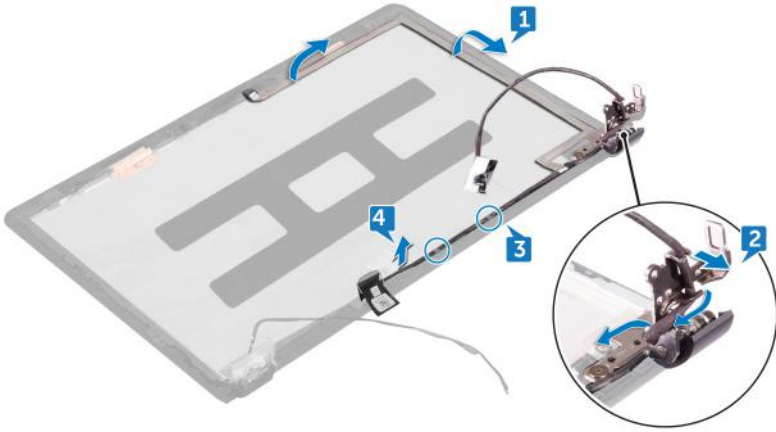

Replacing the display cable



WARNING: Before working inside your computer, read the safety information that shipped with your computer and follow the steps in [Before working inside your computer](#). After working inside your computer, follow the instructions in [After working inside your computer](#). For more safety best practices, see the Regulatory Compliance home page at www.dell.com/regulatory_compliance.

Procedure

- 1 Align the display cable with the slots on the display back-cover and antenna assembly.
- 2 Route the cable through the routing guides on the display back-cover and antenna assembly.
- 3 Route the cable through the routing guides on the display hinge and bracket assembly.
- 4 Adhere the display cable to the display back-cover and antenna assembly.

Post-requisites

- 1 Replace the [camera](#).
- 2 Replace the [display panel](#).
- 3 Replace the [display bezel](#).
- 4 Replace the [display assembly](#).
- 5 Replace the [fans](#).
- 6 Replace the [palm-rest assembly](#).
- 7 Replace the [keyboard](#).
- 8 Follow the procedure from step 4 to step 6 in "[Replacing the hard drive](#)".
- 9 Replace the [battery](#).

10 Replace the [base cover](#).



GUID-5FDA8E9B-5CB1-4057-8C24-222940B45611

Removing the display hinge and bracket assembly



WARNING: Before working inside your computer, read the safety information that shipped with your computer and follow the steps in [Before working inside your computer](#). After working inside your computer, follow the instructions in [After working inside your computer](#). For more safety best practices, see the Regulatory Compliance home page at www.dell.com/regulatory_compliance.

GUID-FD772283-A563-47E4-879F-0A972338692A

Prerequisites



NOTE: These instructions are applicable only for laptops with a non-touch screen display.

- 1 Remove the [base cover](#).
- 2 Remove the [battery](#).
- 3 Follow the procedure from step 1 to step 3 in “[Removing the hard drive](#)”.
- 4 Remove the [keyboard](#)
- 5 Remove the [palm-rest assembly](#).
- 6 Remove the [fans](#).
- 7 Remove the [display assembly](#).
- 8 Remove the [display bezel](#).
- 9 Remove the [display panel](#).

GUID-BE9E2DE8-EFDE-486F-B799-D10F03347536

Procedure

- 1 Note the antenna-cable routing and remove the antenna cables from the routing guides on the display hinges.



- 2 Note the display cable routing and remove the display cable from the routing guides on the display hinges.
- 3 Remove the four screws (M2x3) that secure the display hinges to the display back-cover.
- 4 Remove the two screws (M2x3) that secure the bracket assembly to the display back-cover.
- 5 Release the display hinge and bracket assembly from the latches on the display back-cover.
- 6 Lift the display hinge and bracket assembly off the display back-cover.

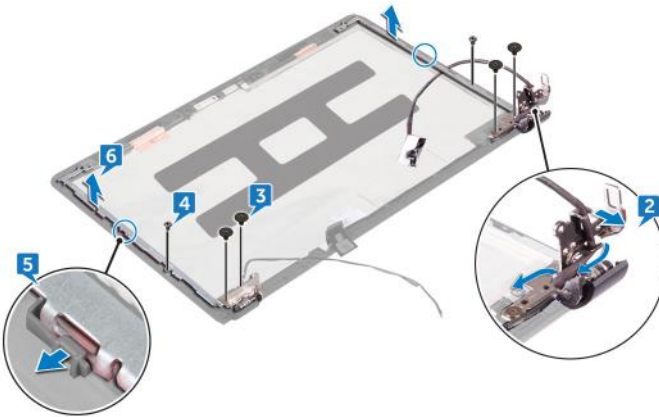

Replacing the display hinge and bracket assembly



WARNING: Before working inside your computer, read the safety information that shipped with your computer and follow the steps in [Before working inside your computer](#). After working inside your computer, follow the instructions in [After working inside your computer](#). For more safety best practices, see the Regulatory Compliance home page at www.dell.com/regulatory_compliance.

Procedure

- 1 Slide the hinge and bracket assembly under the latches on the display back-cover and snap it into place.
- 2 Align the screw holes on the display hinge and bracket assembly with the screw holes on the display back-cover.
- 3 Replace the four screws (M2x3) that secure the display hinges to the display back-cover.
- 4 Replace the two screws (M2x3) that secure the bracket assembly to the display back-cover.

Post-requisites

- 1 Replace the [display panel](#).
- 2 Replace the [display bezel](#).
- 3 Replace the [display assembly](#).
- 4 Replace the [fans](#).
- 5 Replace the [palm-rest assembly](#).
- 6 Replace the [keyboard](#).

- 7 Follow the procedure from step 4 to step 6 in "[Replacing the hard drive](#)".
- 8 Replace the [battery](#).
- 9 Replace the [base cover](#).



Removing the display back-cover and antenna assembly



WARNING: Before working inside your computer, read the safety information that shipped with your computer and follow the steps in [Before working inside your computer](#). After working inside your computer, follow the instructions in [After working inside your computer](#). For more safety best practices, see the Regulatory Compliance home page at www.dell.com/regulatory_compliance.

Prerequisites



NOTE: These instructions are applicable only for laptops with a non-touch screen display.

- 1 Remove the [base cover](#).
- 2 Remove the [battery](#).
- 3 Follow the procedure from step 1 to step 3 in “[Removing the hard drive](#)”.
- 4 Remove the [keyboard](#)
- 5 Remove the [palm-rest assembly](#).
- 6 Remove the [fans](#).
- 7 Remove the [display assembly](#).
- 8 Remove the [display bezel](#).
- 9 Remove the [display panel](#).
- 10 Remove the [display hinge and bracket assembly](#).
- 11 Remove the [camera](#).

Procedure

After performing the steps mentioned in the pre-requisites, we are left with the display back-cover and antenna assembly.

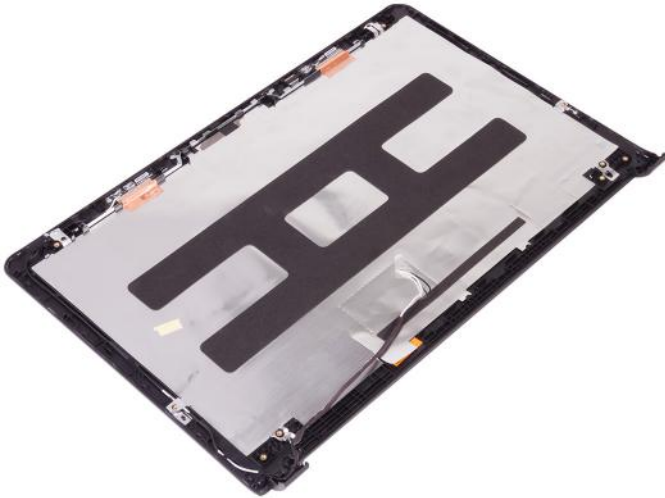

GUID-2EF50600-2483-40F4-A773-07DC95179CB6

Replacing the display back-cover and antenna assembly



WARNING: Before working inside your computer, read the safety information that shipped with your computer and follow the steps in [Before working inside your computer](#). After working inside your computer, follow the instructions in [After working inside your computer](#). For more safety best practices, see the Regulatory Compliance home page at www.dell.com/regulatory_compliance.

GUID-DE1F87B0-274E-4E23-89C1-ADDD8A4BC807

Procedure

Place the display back-cover and antenna assembly on a clean, flat surface.

GUID-CB2CC875-B446-48D8-B1F8-781F745D0ACC

Post-requisites

- 1 Replace the [camera](#).
- 2 Replace the [display hinge and bracket assembly](#).
- 3 Replace the [display panel](#).
- 4 Replace the [display bezel](#).
- 5 Replace the [display assembly](#).
- 6 Replace the [fans](#).
- 7 Replace the [palm-rest assembly](#).
- 8 Replace the [keyboard](#).
- 9 Follow the procedure from step 4 to step 6 in "[Replacing the hard drive](#)".
- 10 Replace the [battery](#).
- 11 Replace the [base cover](#).

Flashing the BIOS

You may need to flash (update) the BIOS when an update is available or when you replace the system board. To flash the BIOS:

- 1 Turn on your computer.
- 2 Go to www.dell.com/support.
- 3 Click **Product support**, enter the Service Tag of your computer, and then click **Submit**.



NOTE: If you do not have the Service Tag, use the auto-detect feature or manually browse for your computer model.

- 4 Click **Drivers & downloads** → **Find it myself**.
- 5 Select the operating system installed on your computer.
- 6 Scroll down the page and expand **BIOS**.
- 7 Click **Download** to download the latest version of the BIOS for your computer.
- 8 After the download is complete, navigate to the folder where you saved the BIOS update file.
- 9 Double-click the BIOS update file icon and follow the instructions on the screen.



Diagnosics

Power and battery-status light/ hard-drive activity light: Indicates the battery-charge status or the hard-drive activity.

 **NOTE: Press Fn+H to toggle this light between power and battery-status light and hard-drive activity light.**

Hard-drive activity light

Turns on when the computer reads from or writes to the hard drive.

Power and battery-status light

Indicates the power and battery-charge status.

Solid white – Power adapter is connected and the battery has more than 5 percent charge.

Amber – Computer is running on battery and the battery has less than 5 percent charge.

Off

- Power adapter is connected and the battery is fully charged.
- Computer is running on battery and the battery has more than 5 percent charge.
- Computer is in sleep state, hibernation, or turned off.

For example, the power and battery-status light blinks amber two times followed by a pause, and then blinks white three times followed by a pause. This 2,3 pattern continues until the computer is turned off indicating no memory or RAM is detected.

The following table shows different light patterns and what they indicate.

Table 3. Diagnosics

Light pattern	Problem description
2,1	CPU failure
2,2	System board: BIOS and ROM failure
2,3	No memory or RAM detected
2,4	Memory or RAM failure

Light pattern	Problem description
2,5	Invalid memory installed
2,6	System board or chipset error
2,7	LCD failure
3,1	CMOS battery failure
3,2	PCI/video card failure
3,3	Recovery image not found
3,4	Recovery image found but invalid

Camera status light: Indicates whether the camera is in use.

- Solid white – Camera is in use.
- Off – Camera is not in use.

Caps Lock status light: Indicates whether Caps Lock is enabled or disabled.

- Solid white – Caps Lock enabled.
- Off – Caps Lock disabled.



Getting help and contacting Dell

Self-help resources

You can get information and help on Dell products and services using these self-help resources:

Table 4. Self-help resources

Information about Dell products and services

www.dell.com

Dell Help & Support app



Get started app



Accessing help

In Windows search, type **Help** and **Support**, and press **Enter**.

Online help for operating system

www.dell.com/support/windows

www.dell.com/support/linux

Troubleshooting information, user manuals, setup instructions, product specifications, technical help blogs, drivers, software updates, and so on.

www.dell.com/support

Learn about your operating system, setting up and using your computer, data backup, diagnostics, and so on.

See *Me and My Dell* at www.dell.com/support/manuals.

Contacting Dell

To contact Dell for sales, technical support, or customer service issues, see www.dell.com/contactdell.



NOTE: Availability varies by country and product, and some services may not be available in your country.



NOTE: If you do not have an active internet connection, you can find contact information on your purchase invoice, packing slip, bill, or Dell product catalog.

