

# Nokia BPM+

Compact Wireless Blood Pressure Monitor  
Installation and Operating Instructions (Android users)

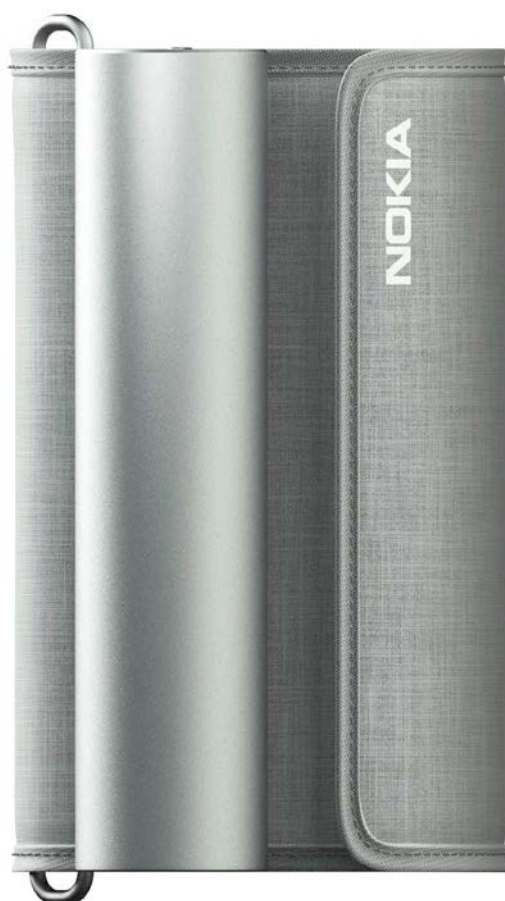

# Table of Contents

---

Minimum Requirements.....	5
Smartphone or Device.....	5
OS version.....	5
Nokia BPM+ Description.....	6
Overview .....	6
Box Contents .....	6
Product Description.....	7
Setting up my Nokia BPM+ .....	8
Installing the Health Mate® app .....	8
Installing my Nokia BPM+ .....	8
Using my Nokia BPM+ .....	15
Positioning myself before and during the measurement .....	15
Taking a measurement .....	18
Understanding the results .....	20
Viewing the history of my measurements.....	22
Managing my data .....	23
Sharing my data with Google Fit.....	23
Dissociating my Nokia BPM+ .....	25
Cleaning and Maintenance .....	26
Cleaning my Nokia BPM+.....	26
Changing the Batteries.....	26
Medical Device .....	28
Personal Data.....	28
Use and Storage .....	29
Safety .....	29
Service and Maintenance .....	29
Specifications .....	30
Document Release Overview.....	32
Warranty .....	33



## Important Notice



By using your Nokia BPM+ you expressly agree to the Nokia Services Terms and Conditions available on our [website](#).

# Minimum Requirements

---

## Smartphone or Device

An iOS or Android device (with operational Bluetooth and Wi-Fi or 3G/4G) is required to:

- Download the Health Mate® app
- Set up your Nokia BPM+
- Access your data

For device compatibility information, refer to "[Specifications](#)" on page 30.

## OS version

You need iOS 8 (or higher) or Android 5.0 (or higher) to install and run the Health Mate® app.

# Nokia BPM+ Description

---

## Overview

The Nokia BPM+ has been designed to be even more travel-friendly. With its soft grey cuff and ultra-slim profile, it is ready to go wherever life takes you. The Nokia BPM+ is a medical device that allows you to accurately track and monitor your blood pressure and heart rate measurements.

Thanks to the cuff oscillometric method, you simply have to wrap the cuff of the Nokia BPM+ around your arm and press the button to get a measurement. Your blood pressure and heart rate measurements are then sent to the Health Mate® app automatically.

The Health Mate® app allows you to easily view the history of your measurements. You can also share data with your family and doctor.

## Box Contents

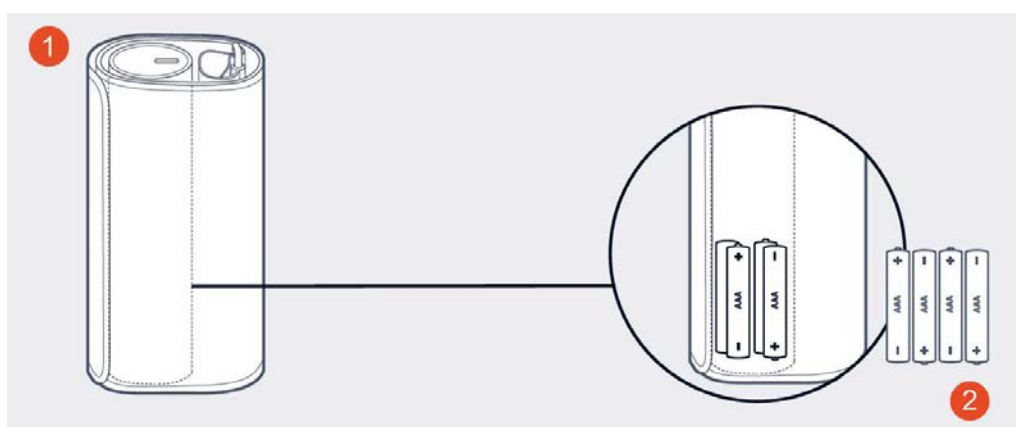

(1) Nokia BPM+

(2) Four AAA alkaline cells  
(already inserted)

## Product Description

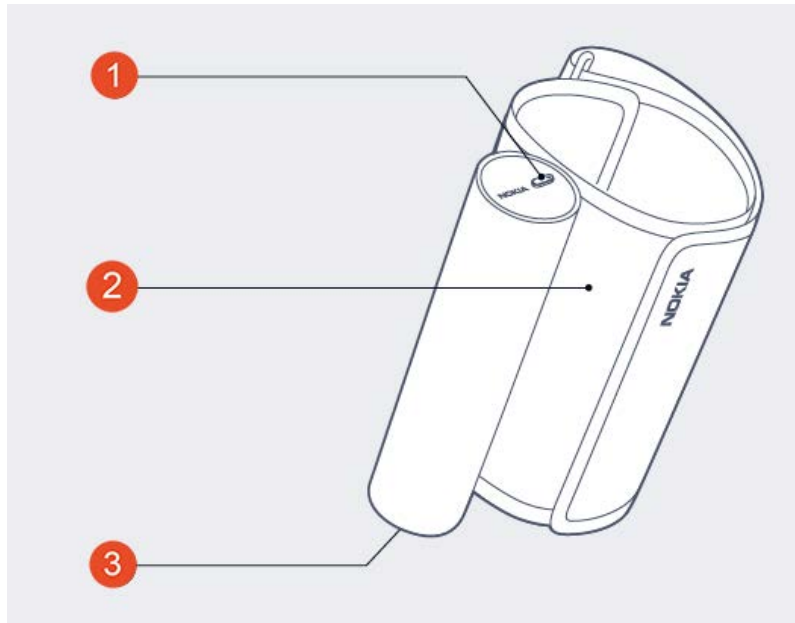

(1) Button

(2) Cuff

(3) Battery cover

# Setting up my Nokia BPM+

---

## Installing the Health Mate® app

If the Health Mate® app is not already installed on your device, perform the following steps:

1. Type [healthapp.nokia.com](http://healthapp.nokia.com) in your device's web browser.
2. Tap **Android App on Google play**.
3. Tap **INSTALL**.  
The installation process starts.

When a new version of the Health Mate® app is available, you will automatically be prompted to update it.

## Installing my Nokia BPM+

### I'm new to Health Mate®

If you don't already have a Health Mate® account, you have to create one in order to set up and use your Nokia BPM+.

If you already have an account, refer to "[I already have a Health Mate® account](#)" on [page 11](#)

To install your Nokia BPM+, perform the following steps:

1. Open the Health Mate® app.
2. Tap **Get started**.

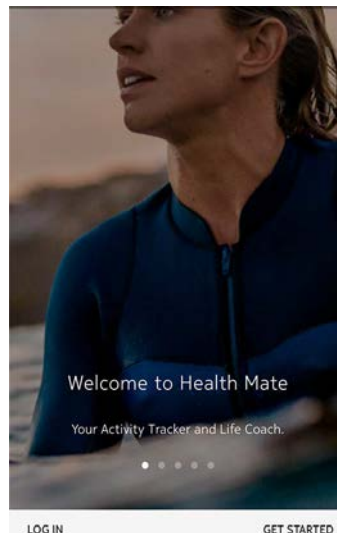

3. Tap **I'm setting up a device.**

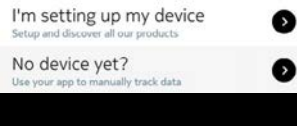

4. Tap **Blood Pressure Monitors.**



5. Tap **Nokia BPM+.**



6. Tap **Install.**

7. Press the button of the Nokia BPM+.



The LED of the Nokia BPM+ lights up blue and starts blinking.

- 8. Tap **Next** in the app.
- 9. Tap **Next**.



10. Enter your email and password. Tap **Next**.



11. Enter your first name, surname and birthday.

12. Select your gender and enter your height and weight. Tap **Next**.

13. Tap **Start**.

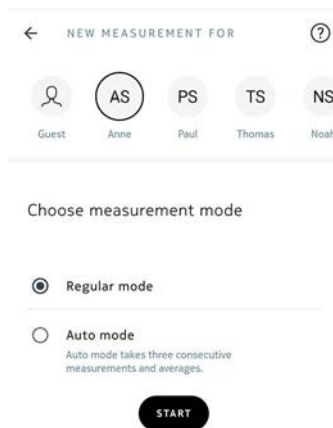

14. Tap **Done** at the end of the measurement.

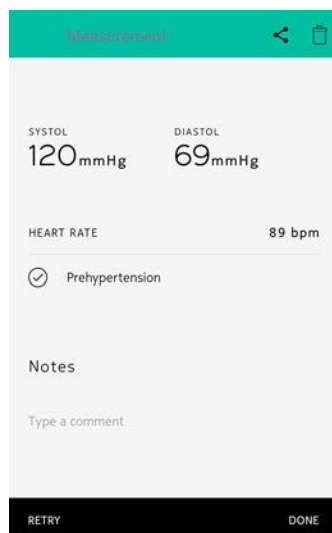

If you want to take another measurement, tap on **Retry**.

### **I already have a Health Mate® account**

If you already have a Health Mate® account, you can get started on the installation process. To do so, perform the following steps:

1. Open the Health Mate® app.
2. Log in to your account, if you already have one, or create one.
3. Tap **My devices**.

4. Tap **+**.

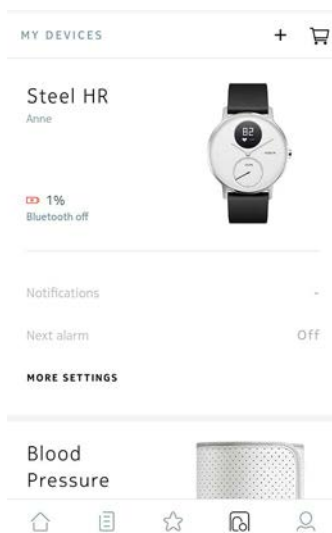

5. Tap **Blood Pressure Monitors**.



6. Tap **Nokia BPM+**.

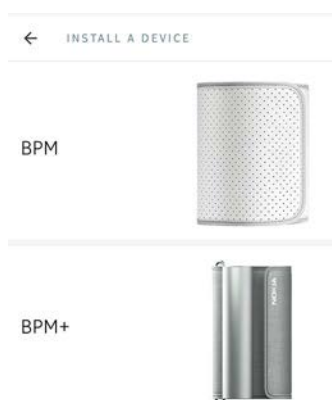

7. Tap **Next**.

8. Press the button of the Nokia BPM+.



The LED of the Nokia BPM+ lights up blue and starts blinking.

9. Tap **Next** in the app.

10. Tap **Next**.



11. Tap **Start**.

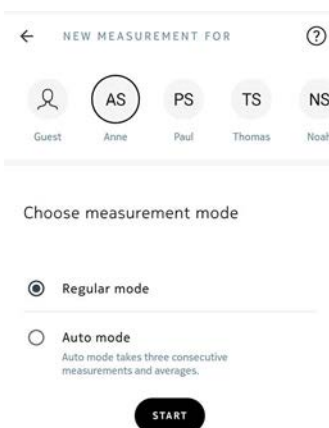

12. Tap **Done** at the end of the measurement.

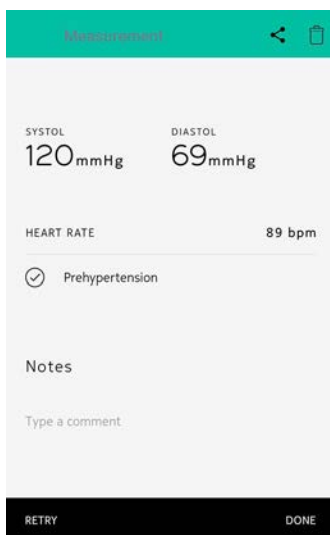

If you want to take another measurement, tap on **Retry**.

## Positioning myself before and during the measurement

Make sure you follow these guidelines when taking a measurement. Failing to do so may lead to inaccurate results or cause the measurements to fail.

1. Sit down in a comfortable position.

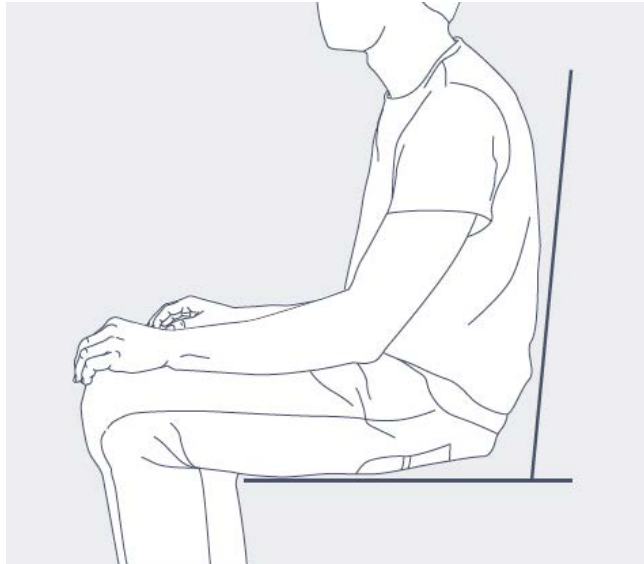

2. Make sure you rest for five minutes before taking a measurement.
3. Unroll the cuff. Place your arm inside it.

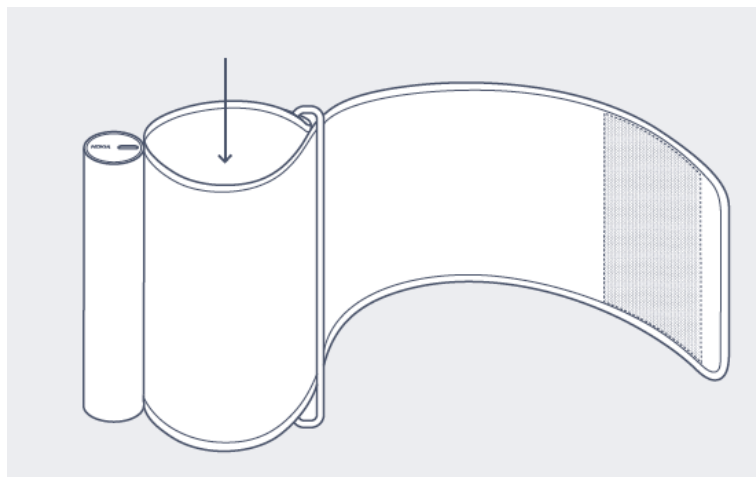

4. Tighten the cuff around your arm, about 1 inch (2 centimeters) above your elbow.

5. Make sure that the metal tube is positioned against your inner arm.



6. Place your arm on a table, slightly flexed and level with your heart.

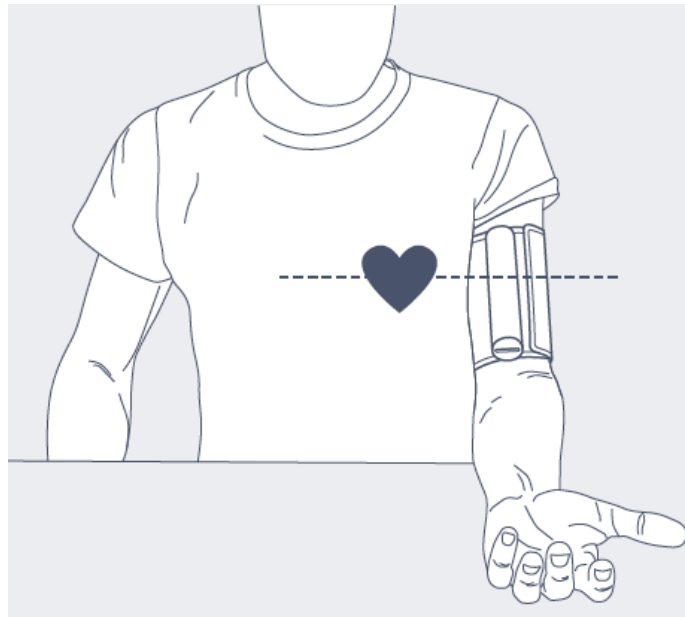

7. Turn on your Nokia BPM+.

The Health Mate® app starts automatically.



8. Press the **Start** button to launch the measurement.

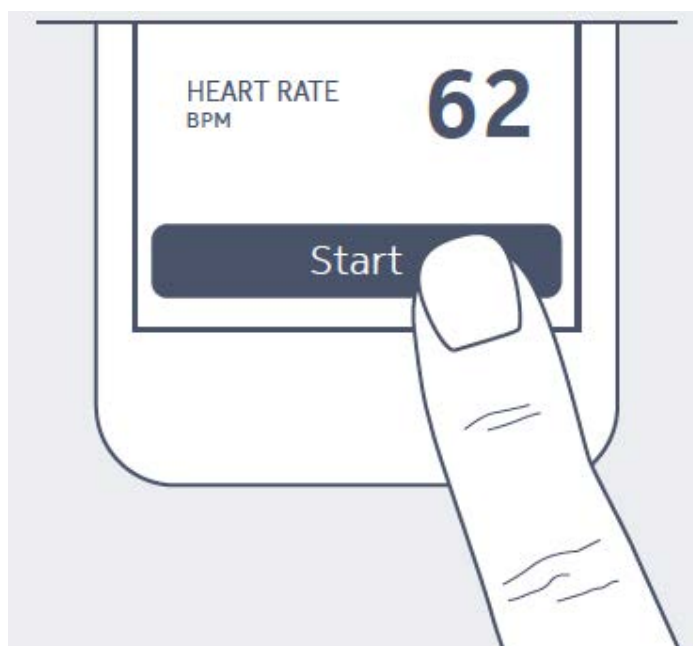

## Taking a measurement

To take a measurement, perform the following steps:

1. Position the Nokia BPM+.  
For more information on how to position the Nokia BPM+, refer to "[Positioning myself before and during the measurement](#)" on page 15.
2. Turn on the screen of your phone.
3. Press the button of the Nokia BPM+.  
The Health Mate® app launches.
4. Tap the user name below **New measurement for** if you want to take an anonymous measurement or take a measurement linked to another user profile.

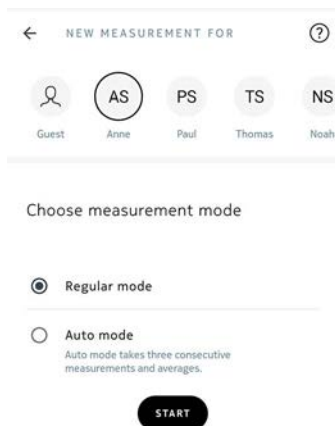

At this point, you have the possibility to take an automatic measurement. This option allows you to take three consecutive measurements, and to obtain the average of the three measurements.

5. If you want to take an automatic measurement, tap **Automatic mode**.

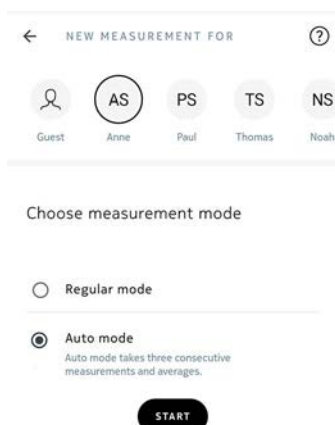

6. Tap **Start**.

7. Tap > to see the tutorial or tap **Skip**.

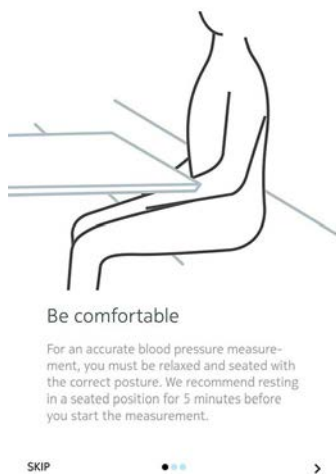

Make sure you stay as still as possible and avoid talking during the measurement. Any movement may impact your results.

8. Tap **Done** at the end of the measurement.

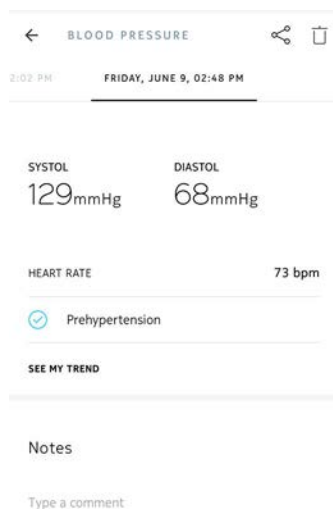

# Understanding the results

## US and Canada

Compare your results to the table below to understand them better.

Blood Pressure Category	Systolic (mmHg)		Diastolic (mmHg)	
Normal	Less than 120	AND	Less than à 80	Green
Prehypertension	120-139	OR	80-89	Green
High Blood Pressure (Hypertension) Stage 1	140-159	OR	90-99	Yellow
High Blood Pressure (Hypertension) Stage 2	160 or higher	OR	100 or higher	Yellow
Hypertensive Crisis (Emergency care needed)	Higher than 180	OR	Higher than 110	Red

This classification is taken from the 2013 guidelines of the American Heart Association.

This classification is based on the values of seated blood pressure measured in a doctor's office or hospital by a healthcare professional.

International guidelines suggest that the following blood pressure readings obtained by self-measurement (measurement taken at home) indicate high blood pressure:

- Systolic blood pressure  $\geq$  135 mmHg
- Diastolic blood pressure  $\geq$  85 mmHg

The color code of this classification is from the article “CoCo trial: Color-coded blood pressure Control, a randomized controlled study”.

## European Union

Compare your results to the table below to understand them better.

Class	Systolic blood pressure (mmHg)		Diastolic blood pressure (mmHg)	
Optimal	< 120	AND	< 80	Green
Normal	120-129	AND/OR	80-84	Light Green
High normal	130-139	AND/OR	85-89	Yellow-Green
Grade 1 hypertension	140-159	AND/OR	90-99	Yellow
Grade 2 hypertension	160-179	AND/OR	100-109	Orange
Grade 3 hypertension	≥ 180	AND/OR	≥ 110	Red
Isolated systolic hypertension	≥ 140	AND	< 90	Dark Red

This classification is taken from the 2013 guidelines of the American Heart Association.

This classification is based on the values of seated blood pressure measured in the office or hospital by a healthcare professional.

International guidelines suggest that the following blood pressure readings obtained by self-measurement (measurement taken at home) indicate high blood pressure:

- Systolic blood pressure  $\geq 135$  mmHg
- Diastolic blood pressure  $\geq 85$  mmHg

The color code of this classification is from the article “CoCo trial: Color-coded blood pressure Control, a randomized controlled study”.

## Viewing the history of my measurements

As soon as you take your blood pressure and your heart rate, your measurements are sent to the Health Mate® app.

To see detailed about your measurements, and see your full history, you have to check your data on the Health Mate® app.

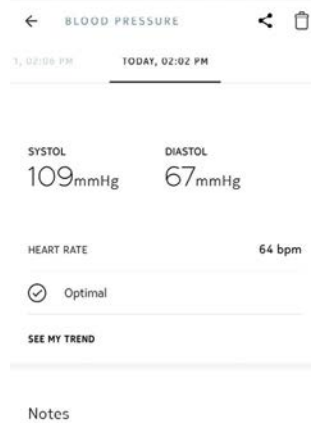

You can access your data by tapping **See my trend** in any blood pressure measurement in your Timeline. To access your heart rate measurement data, tap any item in your Timeline.

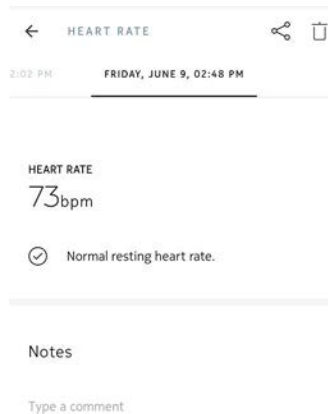

## Sharing my data with Google Fit

The Health Mate® app can share the heart rate measurements with Google Fit.

To link your accounts, perform the following steps:

1. Open the Health Mate app.
2. Tap **Profile**.
3. Tap **Google Fit**.

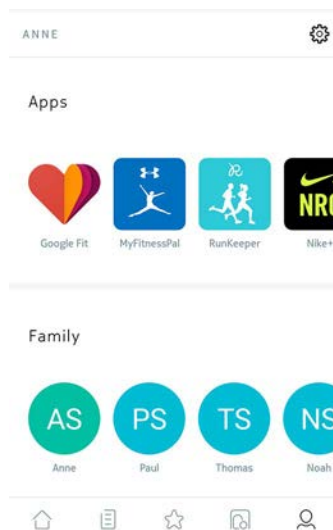

4. Tap the toggle to activate the Google Fit integration.

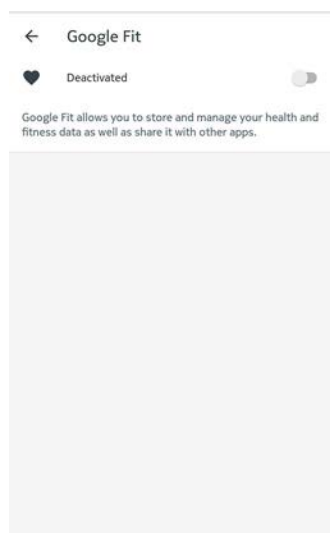

5. Select the Google account you want to link your Health Mate account to.
6. Tap **OK** twice.

## Deleting data

You have the possibility to delete your heart rate and blood pressure measurements from the Health Mate® app. To do so, perform the following steps:

1. Open the Health Mate® app.
2. Swipe the value which you want to delete measurement.



3. Tap **Delete**.

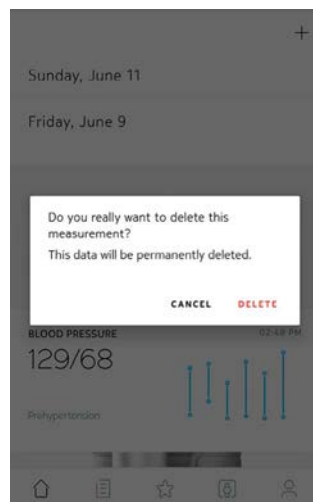

# Dissociating my Nokia BPM+

If you want to stop using your Nokia BPM+, you have to dissociate it from your account first.



**Dissociating your Nokia BPM+ will not remove any of the data that was synced from the Health Mate® app.**

To dissociate your Nokia BPM+, perform the following steps:

1. Open the Health Mate® app.
2. Go to **My devices**.
3. Tap **Nokia BPM+**.

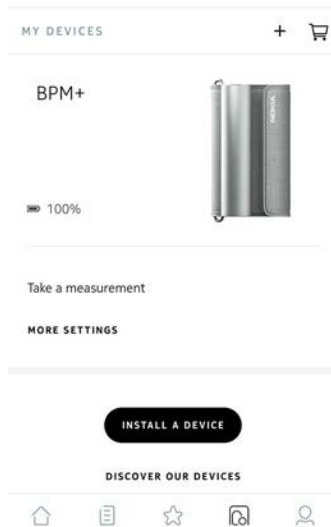

4. Tap **Dissociate**.
5. Tap **Remove from my account**.

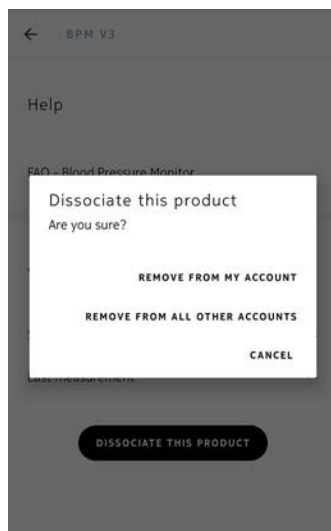

# Cleaning and Maintenance

---

## Cleaning my Nokia BPM+

You can clean your Nokia BPM+ using a cloth dampened with water. Do not put the Nokia BPM+'s cuff in a washing machine or submerge it in water as it contains electronic components



**Do not, under any circumstance, use any solvent to clean your Nokia BPM+.**

## Changing the Batteries

To check the battery level of your Nokia BPM+, perform the following steps:

1. Open the Health Mate® app.
2. Go to **My devices**.
3. Tap **Nokia BPM+**.

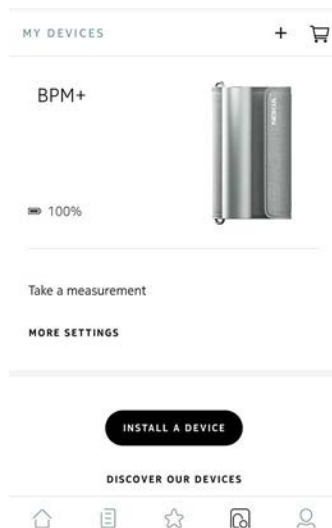

4. Check the battery level displayed at the top.

If the battery level is below 20%, we advise that you change the batteries. Your Nokia BPM+ uses four AAA alkaline batteries (LR3). To change the batteries of your Nokia BPM+, perform the following steps:

1. Make sure the Nokia BPM+ is turned off.  
If the LED is on, press the button for 3 seconds.

2. Turn the slot of the twist cover counterclockwise using a coin to remove the battery cover.

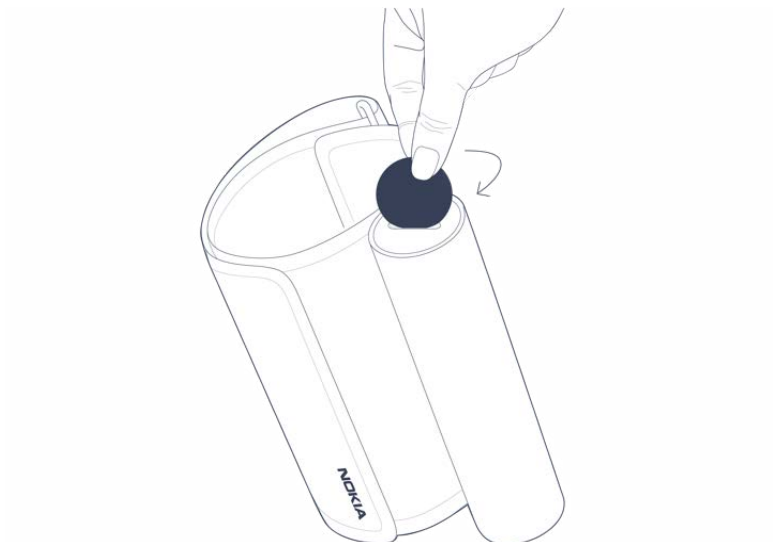

3. Replace the batteries.  
Make sure the batteries are correctly inserted by following the polarity markings.
4. Put the cover back in place.

# User Guide Copyright

---

This User guide is protected by Intellectual Property laws and copyright. Any reproduction, modification, representation, and/or publication without Nokia® prior approval is strictly prohibited. You may print this User Guide for your personal use exclusively. For any questions, please contact Nokia® at: <http://contact.nokia.com>.

## Legal Notice

---



By using your Nokia BPM+ you expressly agree to the Nokia® Services Terms and Conditions available on our [website](#).

	<b>Identity data</b> means the data which can directly identify you.
	<b>Body metrics data</b> means data which correspond to an accurate measurement of your physical features and your body activity.
	<b>Cookies - technical features</b> mean data, not directly identifying you, which allows you to use our Products and Services and allow us improve your personal experience.

## Medical Device

- The Nokia BPM+ is a medical device and has been validated by competent authorities.
- The Health Mate® app is not a medical device. Any advice or insight given by the app cannot replace medical attention.

## Personal Data

- Make sure you have read our privacy policy, which you can find on our [website](#).
- Make sure your Nokia® account password is secure enough to restrict access to your account. It should be at least eight-character long, have mixed case, and use a combination of alphanumeric and special characters.

# Safety Instructions

---

## Use and Storage

- Use the product at temperatures between 10°C and 40°C (50°F and 104°F).
- Product may be stored in a clean, dry location between -25°C and 55°C (-13°F and 131°F) when not in use.
- Remove the batteries if you do not plan to use your Nokia BPM+ for an extended period of time.
- The Nokia BPM+ is only meant to track your blood pressure and heart rate measurements, exclusively by wrapping it around your arm. Any other use is prohibited.

## Safety

- Make sure you consult a doctor should the symptoms be persistent or worrying in any way.
- Do not allow your Nokia BPM+ to come in contact with liquids. If it gets wet, make sure you let it dry before trying to use it.
- Do not leave your Nokia BPM+ exposed to dust or sunlight for too long as it might damage the product.
- Keep your Nokia BPM+ and its accessories out of reach from children, as it contains small parts and may present a choking hazard.

## Service and Maintenance

- Do not attempt to repair or modify your Nokia BPM+ on your own.
- If you have any issue, feel free to contact our Customer Service at: <http://contact.nokia.com>.

# Specifications

---

## Nokia BPM+

- Length: 165 mm (6.5 in.)
- Width: 60 mm (2.4 in.)
- Weight: 390 g (0.859 lb) with batteries
- Cuff circumference: fits arm circumferences 22 to 42 cm (9 to 17 in)

## Connectivity

- Bluetooth 4.0 connectivity

## Storage and memory

- Free and unlimited online storage of blood pressure data
- Up to 100 measurements can be stored on the Nokia BPM+ if the smartphone is not connected to the Internet

## Technology

- Cuff oscillo metric method
- Measurement range: 0 to 285 mmHg
- Accuracy:  $\pm 3$  mmHg or 2% of reading
- Inflation: automatic inflation
- Controlled release

## Certifications

- FDA and Medical EC approved
- ANSI/AAMI SP10: 2002/A1 2003(R) 2008
- FCC part B 15B: 2013

## International standards

- European Society of Hypertension (ESH) for all countries except USA and Canada
- American Society of Hypertension (ASH) for USA and Canada

## Metrics

- Heart rate measurement range: from 40 to 180 beats per minute
- Accuracy: 5% of reading

## Battery life

- Four AAA (LR03) batteries (provided and already installed)
- One year autonomy (based on one measurement per day)

## Compatible devices

- iPhone (4S or higher)
- Apple Watch
- iPod Touch (5th generation or higher)
- iPad (3rd generation or higher)

## Compatible OS

- Android 5.0 or higher
- iOS 8.0 or higher

## Apps

- Health Mate® App
- Apple Health App
- Google Fit App

# Document Release Overview

---

Release date		Modifications
June 2017	v1.0	First release



**The screenshots in this manual are used for explanatory purposes. Your actual screens may differ from the screenshots in this manual.**

# Warranty

---

## Nokia® One (1) Year Limited Warranty - Nokia BPM+

Nokia® warrants the Nokia® branded hardware product (“Nokia BPM+”) against defects in materials and workmanship when used normally in accordance with Nokia®’ published guidelines for a period of ONE (1) YEAR from the date of original retail purchase by the end-user purchaser (“Warranty Period”). Nokia® published guidelines include but are not limited to information contained in technical specifications, safety instructions or quick start guide. Withings does not warrant that the operation of the Nokia BPM+ will be uninterrupted or error-free. Nokia® is not responsible for damage arising from failure to follow instructions relating to the Nokia BPM+’s use.

# Regulatory Statements

---

## Federal Communications Commission (FCC) Statement

FCC ID: XNAWPM03

This device complies with Part 15 of the FCC Rules. This equipment complies with FCC radiation exposure limits set forth for an uncontrolled environment. End users must follow the specific operating instructions for satisfying RF exposure compliance. This transmitter must not be co-located or operated in conjunction with any other antenna or transmitter.

Operation is subject to the following two conditions:

- (1) This device may not cause harmful interference, and
- (2) This device must accept any interference received, including interference that may cause undesired operation.

This device complies with the R&TTE Directive 1999/5/CE.

A copy of the EU Declaration of Conformity is available online at [nokia.com/compliance](http://nokia.com/compliance)

# Nokia BPM+

Compact Wireless Blood Pressure Monitor  
Installation and Operating Instructions (iOS users)

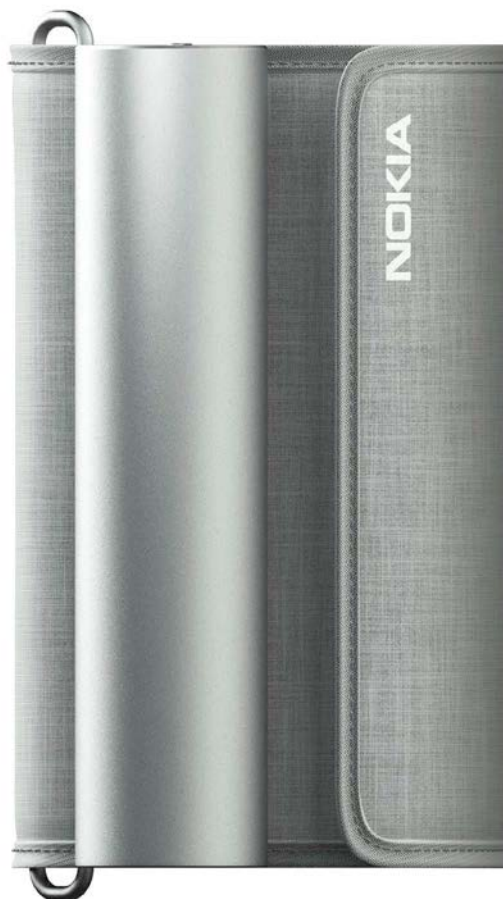

# Table of Contents

---

Minimum Requirements.....	5
Smartphone or Device.....	5
OS version.....	5
Nokia BPM+ Description.....	6
Overview .....	6
Box Contents .....	6
Product Description.....	7
Setting up my Nokia BPM+ .....	8
Installing the Health Mate® app .....	8
Installing my Nokia BPM+ .....	8
Using my Nokia BPM+ .....	18
Positioning myself before and during the measurement .....	18
Taking a measurement .....	21
Understanding the results .....	23
Getting Insights .....	24
Viewing the history of my measurements.....	28
Managing my data .....	29
Sharing my data with Apple Health.....	29
Dissociating my Nokia BPM+ .....	31
Cleaning and Maintenance .....	32
Cleaning my Nokia BPM+ .....	32
Changing the Batteries.....	32
Medical Device .....	34
Personal Data.....	34
Use and Storage .....	35
Safety .....	35
Service and Maintenance .....	35
Specifications .....	36
Document Release Overview.....	38

Warranty .....	39
Regulatory Statements .....	40

## Important Notice



By using your Nokia BPM+ you expressly agree to the Nokia Services Terms and Conditions available on our [website](#).

# Minimum Requirements

---

## Smartphone or Device

An iOS or Android device (with operational Bluetooth and Wi-Fi or 3G/4G) is required to:

- Download the Health Mate® app
- Set up your Nokia BPM+
- Access your data

For device compatibility information, refer to "[Specifications](#)" on page 36.

## OS version

You need iOS 8 (or higher) or Android 5.0 (or higher) to install and run the Health Mate® app.

# Nokia BPM+ Description

---

## Overview

The Nokia BPM+ has been designed to be even more travel-friendly. With its soft grey cuff and ultra-slim profile, it is ready to go wherever life takes you. The Nokia BPM+ is a medical device that allows you to accurately track and monitor your blood pressure and heart rate measurements.

Thanks to the cuff oscillometric method, you simply have to wrap the cuff of the Nokia BPM+ around your arm and press the button to get a measurement. Your blood pressure and heart rate measurements are then sent to the Health Mate® app automatically.

The Health Mate® app allows you to easily view the history of your measurements. You can also share data with your family and doctor.

## Box Contents

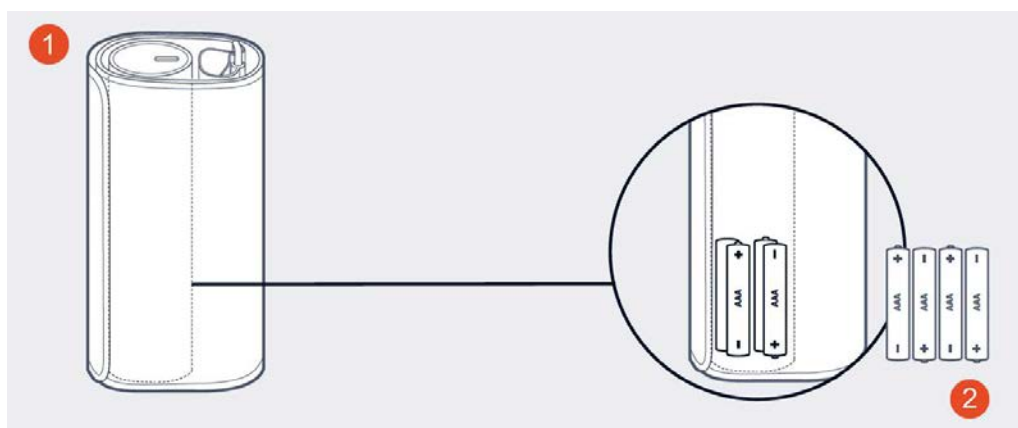

(1) Nokia BPM+

(2) Four AAA alkaline cells  
(already inserted)

## Product Description

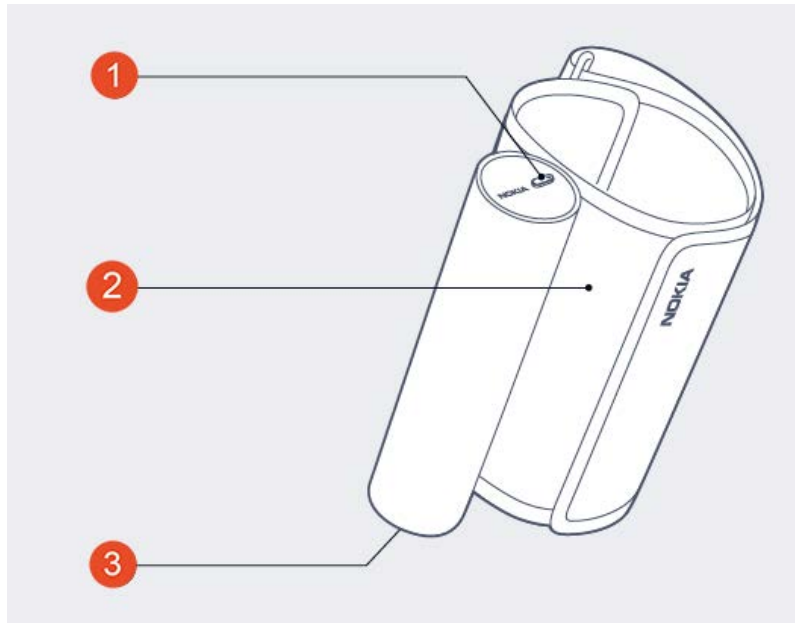

(1) Button

(2) Cuff

(3) Battery cover

# Setting up my Nokia BPM+

---

## Installing the Health Mate® app

If the Health Mate® app is not already installed on your device, perform the following steps:

1. Type [healthapp.nokia.com](http://healthapp.nokia.com) in your device's web browser.
2. Tap **Download on the App Store**.
3. Tap **GET**.  
The installation process starts.

When a new version of the Health Mate® app is available, you will automatically be prompted to update it.

## Installing my Nokia BPM+

### I'm new to Health Mate®

If you don't already have a Health Mate® account, you have to create one in order to set up and use your Nokia BPM+.

If you already have an account, refer to "[I already have a Health Mate® account](#)" on [page 13](#)

To install your Nokia BPM+, perform the following steps:

1. Open the Health Mate® app.
2. Tap **Get started**.



3. Tap **I'm setting up a device.**



4. Tap **Blood Pressure Monitors.**

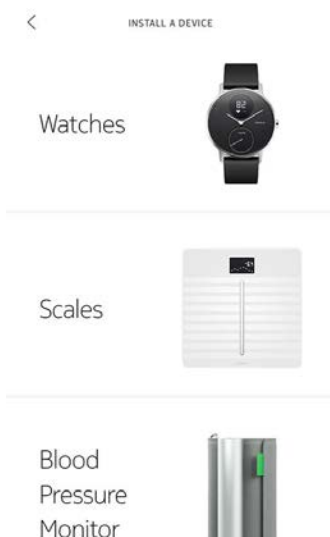

5. Tap **Nokia BPM+.**

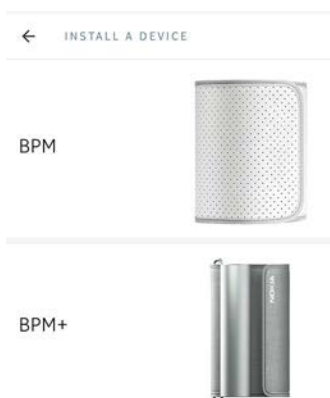

6. Tap **Install.**

7. Press the button of the Nokia BPM+.

CANCEL

Wake up your BPM+

Push the button to wake up your BPM+

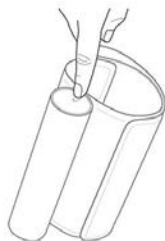

The LED of the Nokia BPM+ lights up blue and starts blinking.

8. Tap **Next** in the app.

9. Tap **Install**.

CANCEL

BPM+ detected



INSTALL

10. Tap **Pair**.

CANCEL

Pair your device with your  
phone



PAIR

11. Tap **Pair**.

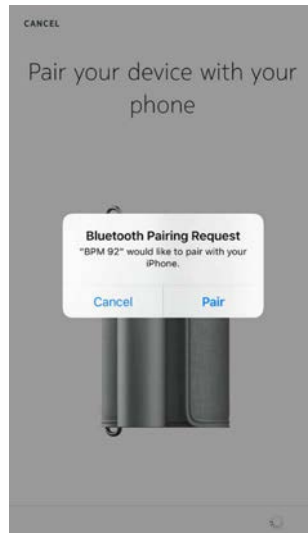

12. Tap **Next**.



13. Enter your email and password. Tap **Create**.



14. Enter your first name, surname and birthday.

15. Select your gender and enter your height and weight. Tap **Next**.

16. Tap **Change the avatar** if you want to change it.

17. Tap **Next**.

You have the possibility to add a family member if you want to.

The Nokia BPM+ is updating and restarting.

18. Tap **Done**.

You're all set!



DONE

19. Tap **Start**.

CANCEL NEW MEASUREMENT FOR HELP



Choose Measurement Mode



START

20. Tap **Done** at the end of the measurement.

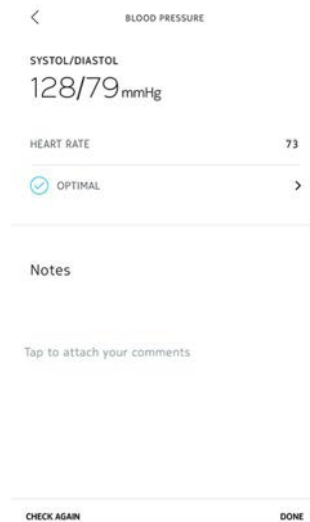

If you want to take another measurement, tap on **Check again**.

### **I already have a Health Mate® account**

If you already have a Health Mate® account, you can get started on the installation process. To do so, perform the following steps:

1. Open the Health Mate® app.
2. Log in to your account, if you already have one, or create one.
3. Tap **My devices**.
4. Tap **+**.

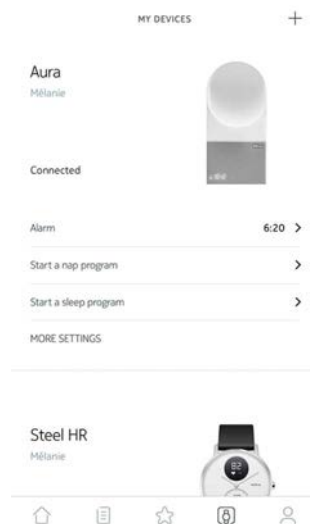

5. Tap **Blood Pressure Monitors**.

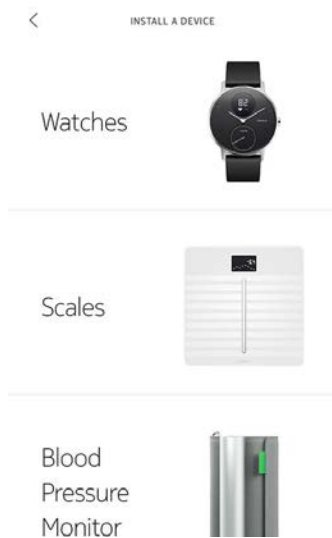

6. Tap **Nokia BPM+**.

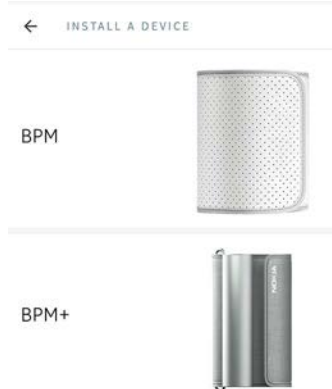

7. Tap **Install**.

8. Press the button of the Nokia BPM+.

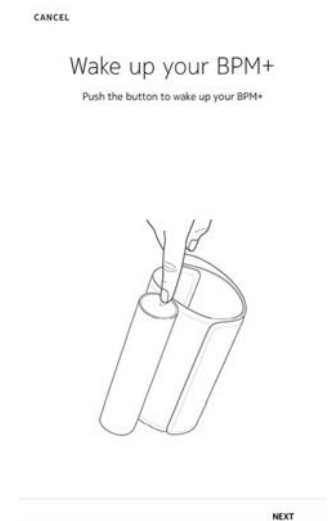

The LED of the Nokia BPM+ lights up blue and starts blinking.

- 9. Tap **Next** in the app.
- 10. Tap **Install**.



- 11. Tap **Pair**.



- 12. Tap **Pair**.

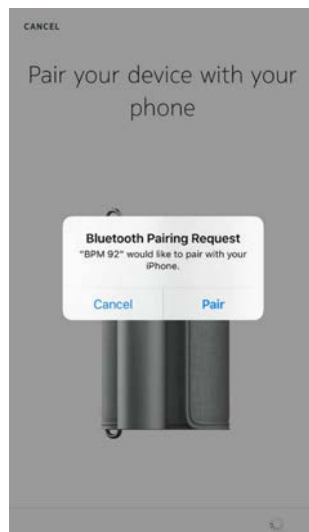

13. Tap **Next**.



14. Tap **Done**.



15. Tap **Start**.

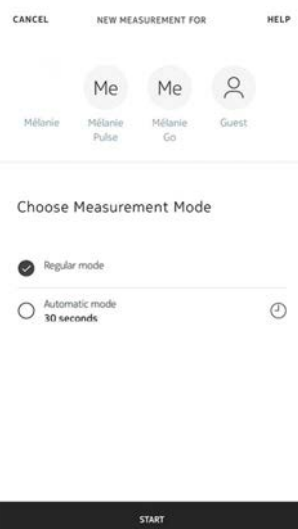

16. Tap **Done** at the end of the measurement.

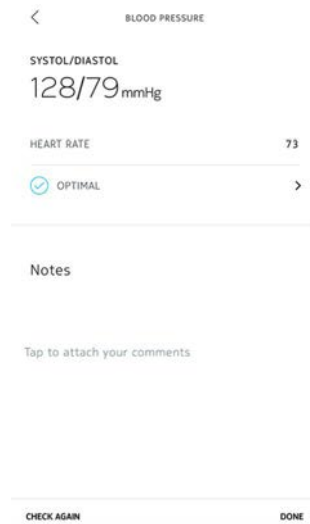

If you want to take another measurement, tap on **Check again**.

## Positioning myself before and during the measurement

Make sure you follow these guidelines when taking a measurement. Failing to do so may lead to inaccurate results or cause the measurements to fail.

1. Sit down in a comfortable position.

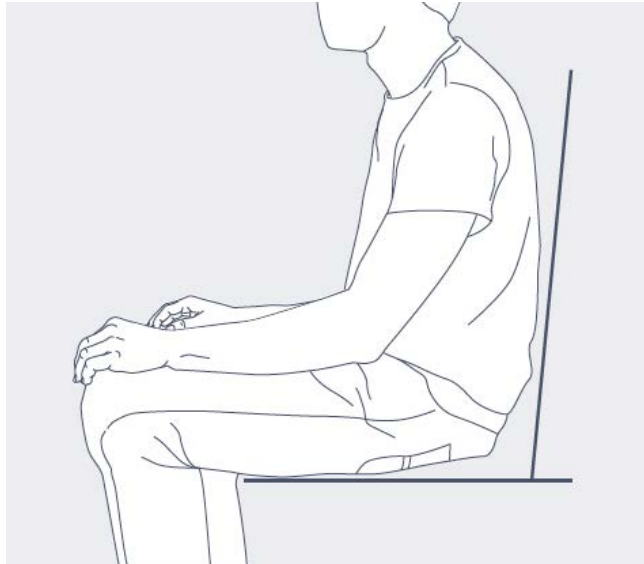

2. Make sure you rest for five minutes before taking a measurement.
3. Unroll the cuff. Place your arm inside it.

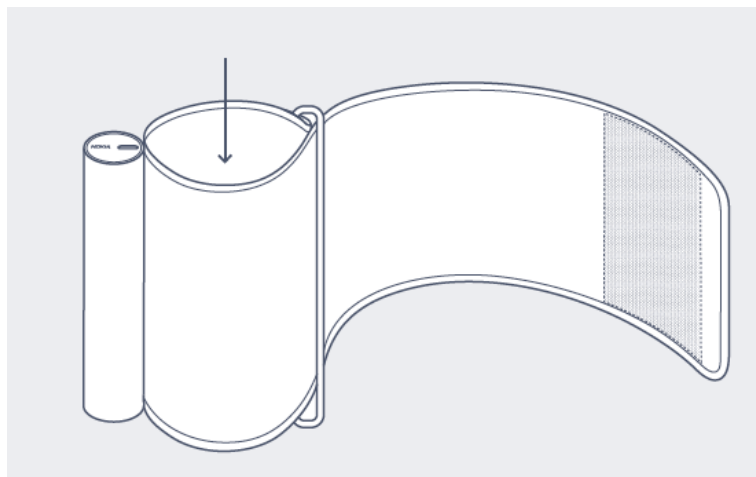

4. Tighten the cuff around your arm, about 1 inch (2 centimeters) above your elbow.

5. Make sure that the metal tube is positioned against your inner arm.



6. Place your arm on a table, slightly flexed and level with your heart.

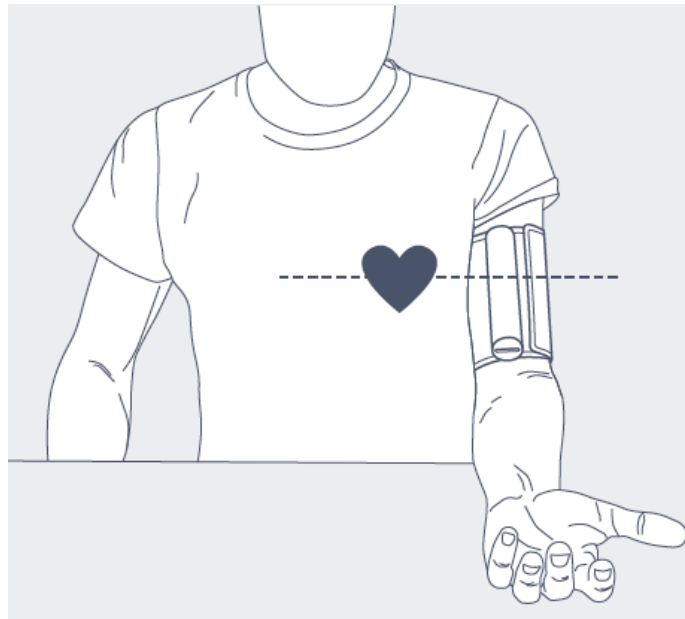

7. Turn on your Nokia BPM+.

The Health Mate® app starts automatically.



8. Press the **Start** button to launch the measurement.

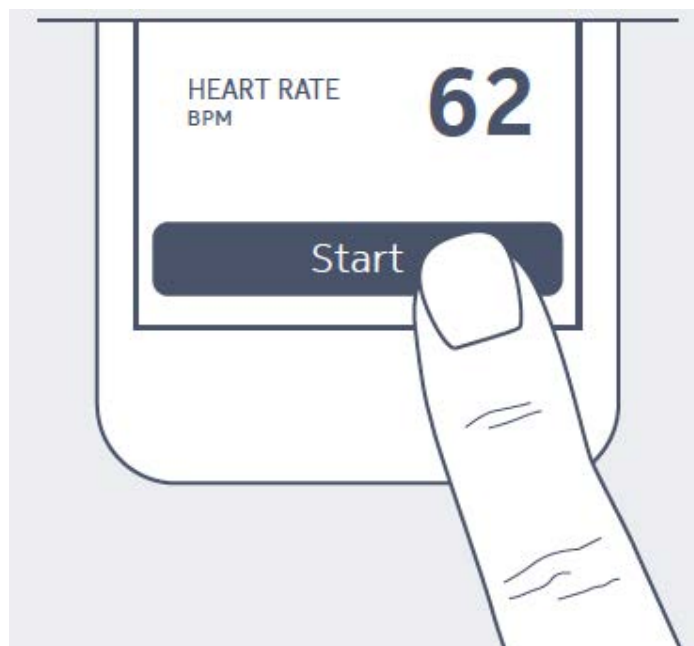

## Taking a measurement

To take a measurement, perform the following steps:

1. Position the Nokia BPM+.  
For more information on how to position the Nokia BPM+, refer to "[Positioning myself before and during the measurement](#)" on page 18.
2. Turn on the screen of your phone.
3. Press the button of the Nokia BPM+.  
The Health Mate® app launches.
4. Tap **Next** to pass through the tutorial.



At this point, you have the possibility to take an automatic measurement. This option allows you to take three consecutive measurements, and to obtain the average of the three measurements.

5. Tap the user name below **New measurement for** if you want to take an anonymous measurement or take a measurement linked to another user profile.
6. If you want to take an automatic measurement, tap **Automatic mode**.

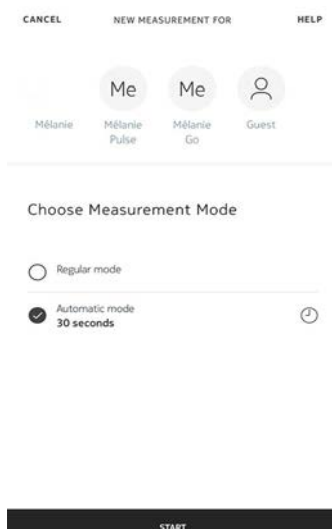

7. Tap **Start**.

Make sure you stay as still as possible and avoid talking during the measurement. Any movement may impact your results.

8. Tap **Done** at the end of the measurement.



# Understanding the results

## US and Canada

Compare your results to the table below to understand them better.

Blood Pressure Category	Systolic (mmHg)		Diastolic (mmHg)	
Normal	Less than 120	AND	Less than à 80	Green
Prehypertension	120-139	OR	80-89	Green
High Blood Pressure (Hypertension) Stage 1	140-159	OR	90-99	Yellow
High Blood Pressure (Hypertension) Stage 2	160 or higher	OR	100 or higher	Yellow
Hypertensive Crisis (Emergency care needed)	Higher than 180	OR	Higher than 110	Red

This classification is taken from the 2013 guidelines of the American Heart Association.

This classification is based on the values of seated blood pressure measured in a doctor's office or hospital by a healthcare professional.

International guidelines suggest that the following blood pressure readings obtained by self-measurement (measurement taken at home) indicate high blood pressure:

- Systolic blood pressure  $\geq 135$  mmHg
- Diastolic blood pressure  $\geq 85$  mmHg

The color code of this classification is from the article “CoCo trial: Color-coded blood pressure Control, a randomized controlled study”.

## European Union

Compare your results to the table below to understand them better.

Class	Systolic blood pressure (mmHg)		Diastolic blood pressure (mmHg)	
Optimal	< 120	AND	< 80	Green
Normal	120-129	AND/OR	80-84	Green
High normal	130-139	AND/OR	85-89	Green
Grade 1 hypertension	140-159	AND/OR	90-99	Yellow
Grade 2 hypertension	160-179	AND/OR	100-109	Yellow
Grade 3 hypertension	≥ 180	AND/OR	≥ 110	Red
Isolated systolic hypertension	≥ 140	AND	< 90	Dark Red

This classification is taken from the 2013 guidelines of the American Heart Association.

This classification is based on the values of seated blood pressure measured in the office or hospital by a healthcare professional.

International guidelines suggest that the following blood pressure readings obtained by self-measurement (measurement taken at home) indicate high blood pressure:

- Systolic blood pressure ≥ 135 mmHg
- Diastolic blood pressure ≥ 85 mmHg

The color code of this classification is from the article “CoCo trial: Color-coded blood pressure Control, a randomized controlled study”.

## Getting Insights

Hy-Result is a medically validated protocol that allows you to test your hypertension from home and share the results with your doctor. It also gives you a complete and precise diagnostic about your blood pressure.

While it is a chargeable option, you can use it as many times as you'd like after the purchase.

## Purchasing Hy-Result

To get the Hy-Result function, perform the following steps:

1. Open the Withings Health Mate™ app.
2. Tap **Wellness Programs**.

### 3. Tap **Hy-Result**.

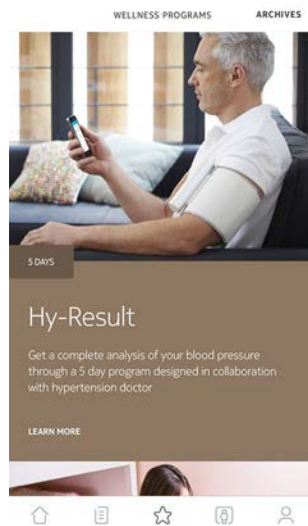

### 4. Tap **Join**.

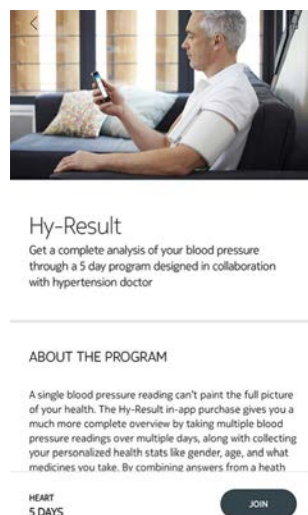

You'll have to enter your Apple ID and password to validate the purchase.

## Setting Hy-Result

Before starting the protocol, you'll have to fill in a form with various information about your health. Please note that none of this information will be shared with Withings or anyone else. Furthermore, this information will only be accessible locally on your iPhone.

Once the purchase is validated, you can start setting Hy-Result. To do so, perform the following steps:

1. Open the Health Mate® app.

## 2. Tap **Wellness Programs**.



## 3. Tap **Hy-Result**.

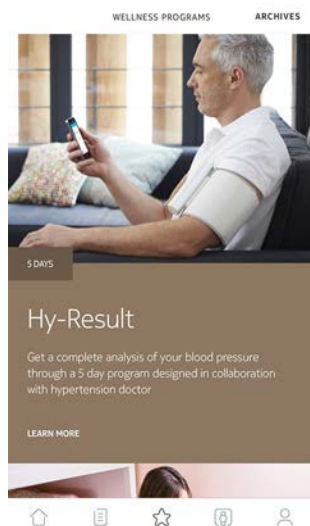

## 4. Tap **Join**.

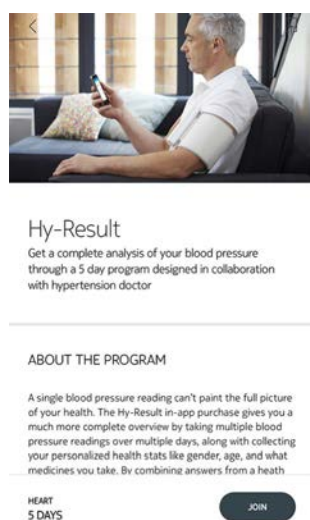

## 5. Set reminders to make sure you don't forget to take your measurements.

## 6. Fill in the form.

7. Tap **OK**.
8. Tap **Done**.  
The protocol will start the next day.

## Using Hy-Result

The Hy-Result protocol takes place over five days. During these five days, you'll have to enter three measurements per half-day (ten half-days in total). You can select one of three ways to enter these measurements:

- Enter three measurements manually
- Take three separate measurements using your Nokia BPM+
- Take an automatic measurement using your Nokia BPM+

To get the results, you can't miss more than two half-days of measurements. If you miss any more than that, you'll have to start the protocol over from the start.

Make sure you don't log out of the Health Mate® app for the entire duration of the Hy-Result protocol. If you do, you'll have to start the protocol over from the start, as your data is only stored locally on your iPhone.

## Viewing the results

Once you have completed the Hy-Result protocol, a PDF will be created with results, containing the following information::

- Your average blood pressure with a color code
- An analysis of your hypertension, validated by medical research
- A PDF report that you can share with your doctor

You will have the opportunity to save this PDF, but for privacy reasons, if you do not save the PDF it will be deleted and you will lose your results. Note that the Hy-Result feature may be used as many times as you would like after purchase.

## Viewing the history of my measurements

As soon as you take your blood pressure and your heart rate, your measurements are sent to the Health Mate® app.

To see detailed about your measurements, and see your full history, you have to check your data on the Health Mate® app.

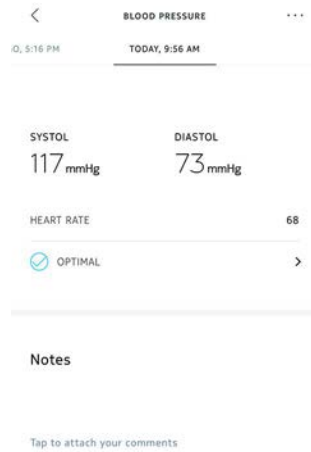

You can access your data by tapping any blood pressure or heart rate measurement item in your Timeline.

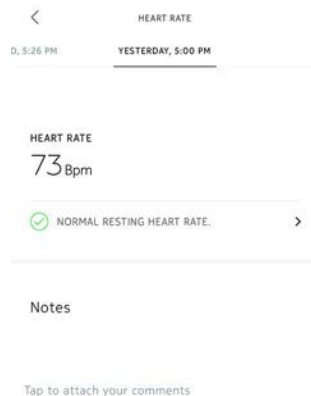

## Sharing my data with Apple Health

The Health Mate® app can share the following data with Apple Health:

- Diastolic Blood Pressure
- Heart Rate
- Systolic Blood Pressure

To link your accounts, perform the following steps:

1. Open the Health Mate app.
2. Tap **Profile**.
3. Tap **Health**.

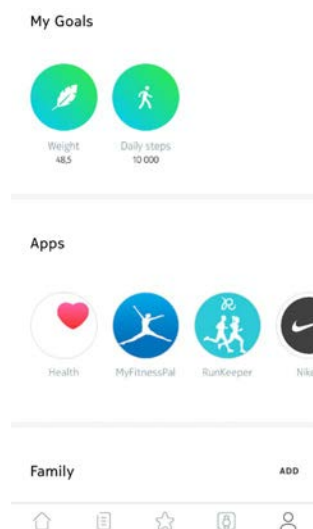

4. Select the data you want to share with Apple Health.

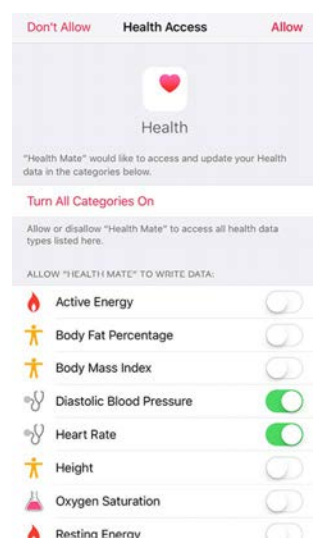

5. Tap **Allow**.

## Deleting data

You have the possibility to delete your heart rate and blood pressure measurements from the Health Mate® app. To do so, perform the following steps:

1. Open the Health Mate® app.
2. Swipe the value which you want to delete measurement.



3. Tap **Delete**.

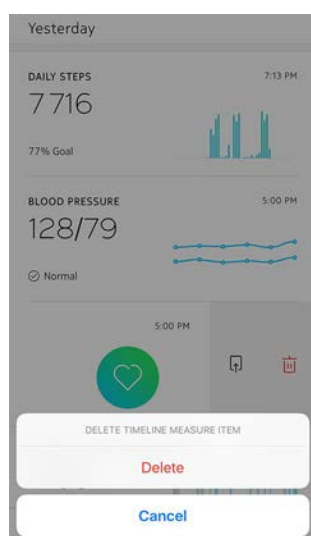

# Dissociating my Nokia BPM+

If you want to stop using your Nokia BPM+, you have to dissociate it from your account first.



**Dissociating your Nokia BPM+ will not remove any of the data that was synced from the Health Mate® app.**

To dissociate your Nokia BPM+, perform the following steps:

1. Open the Health Mate® app.
2. Go to **My devices**.
3. Tap **Nokia BPM+**.

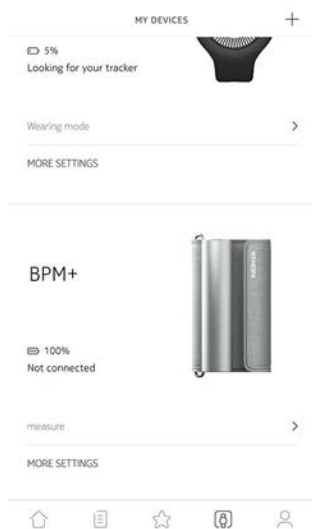

4. Tap **Dissociate**.
5. Tap **Remove from my account**.

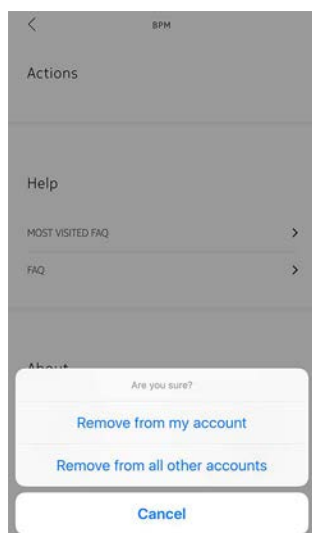

## Cleaning my Nokia BPM+

You can clean your Nokia BPM+ using a cloth dampened with water. Do not put the Nokia BPM+'s cuff in a washing machine or submerge it in water as it contains electronic components



**Do not, under any circumstance, use any solvent to clean your Nokia BPM+.**

## Changing the Batteries

To check the battery level of your Nokia BPM+, perform the following steps:

1. Open the Health Mate® app.
2. Go to **My devices**.
3. Tap **Nokia BPM+**.

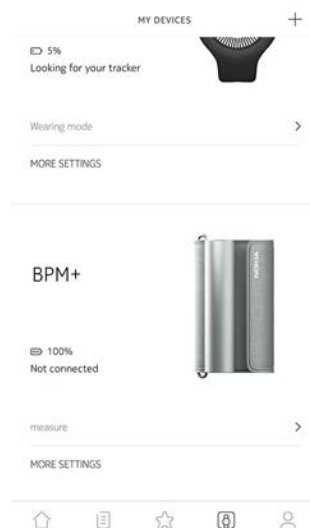

4. Check the battery level displayed at the top.

If the battery level is below 20%, we advise that you change the batteries. Your Nokia BPM+ uses four AAA alkaline batteries (LR3). To change the batteries of your Nokia BPM+, perform the following steps:

1. Make sure the Nokia BPM+ is turned off.  
If the LED is on, press the button for 3 seconds.

2. Turn the slot of the twist cover counterclockwise using a coin to remove the battery cover.

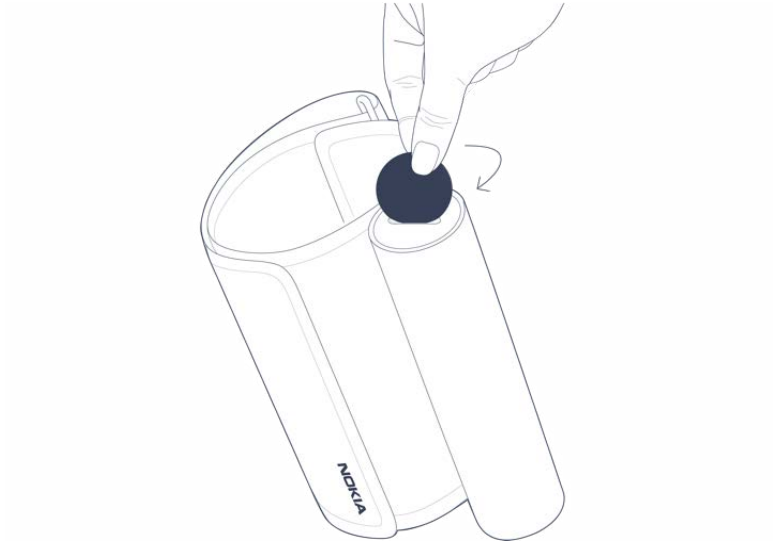

3. Replace the batteries.  
Make sure the batteries are correctly inserted by following the polarity markings.
4. Put the cover back in place.

# User Guide Copyright

---

This User guide is protected by Intellectual Property laws and copyright. Any reproduction, modification, representation, and/or publication without Nokia® prior approval is strictly prohibited. You may print this User Guide for your personal use exclusively. For any questions, please contact Nokia® at: <http://contact.nokia.com>.

## Legal Notice

---



By using your Nokia BPM+ you expressly agree to the Nokia® Services Terms and Conditions available on our [website](#).

	<b>Identity data</b> means the data which can directly identify you.
	<b>Body metrics data</b> means data which correspond to an accurate measurement of your physical features and your body activity.
	<b>Cookies - technical features</b> mean data, not directly identifying you, which allows you to use our Products and Services and allow us improve your personal experience.

## Medical Device

- The Nokia BPM+ is a medical device and has been validated by competent authorities.
- The Health Mate® app is not a medical device. Any advice or insight given by the app cannot replace medical attention.

## Personal Data

- Make sure you have read our privacy policy, which you can find on our [website](#).
- Make sure your Nokia® account password is secure enough to restrict access to your account. It should be at least eight-character long, have mixed case, and use a combination of alphanumeric and special characters.

# Safety Instructions

---

## Use and Storage

- Use the product at temperatures between 10°C and 40°C (50°F and 104°F).
- Product may be stored in a clean, dry location between -25°C and 55°C (-13°F and 131°F) when not in use.
- Remove the batteries if you do not plan to use your Nokia BPM+ for an extended period of time.
- The Nokia BPM+ is only meant to track your blood pressure and heart rate measurements, exclusively by wrapping it around your arm. Any other use is prohibited.

## Safety

- Make sure you consult a doctor should the symptoms be persistent or worrying in any way.
- Do not allow your Nokia BPM+ to come in contact with liquids. If it gets wet, make sure you let it dry before trying to use it.
- Do not leave your Nokia BPM+ exposed to dust or sunlight for too long as it might damage the product.
- Keep your Nokia BPM+ and its accessories out of reach from children, as it contains small parts and may present a choking hazard.

## Service and Maintenance

- Do not attempt to repair or modify your Nokia BPM+ on your own.
- If you have any issue, feel free to contact our Customer Service at: <http://contact.nokia.com>.

# Specifications

---

## Nokia BPM+

- Length: 165 mm (6.5 in.)
- Width: 60 mm (2.4 in.)
- Weight: 390 g (0.859 lb) with batteries
- Cuff circumference: fits arm circumferences 22 to 42 cm (9 to 17 in)

## Connectivity

- Bluetooth 4.0 connectivity

## Storage and memory

- Free and unlimited online storage of blood pressure data
- Up to 100 measurements can be stored on the Nokia BPM+ if the smartphone is not connected to the Internet

## Technology

- Cuff oscillo metric method
- Measurement range: 0 to 285 mmHg
- Accuracy:  $\pm 3$  mmHg or 2% of reading
- Inflation: automatic inflation
- Controlled release

## Certifications

- FDA and Medical EC approved
- ANSI/AAMI SP10: 2002/A1 2003(R) 2008
- FCC part B 15B: 2013

## International standards

- European Society of Hypertension (ESH) for all countries except USA and Canada
- American Society of Hypertension (ASH) for USA and Canada

## Metrics

- Heart rate measurement range: from 40 to 180 beats per minute
- Accuracy: 5% of reading

## Battery life

- Four AAA (LR03) batteries (provided and already installed)
- One year autonomy (based on one measurement per day)

## Compatible devices

- iPhone (4S or higher)
- Apple Watch
- iPod Touch (5th generation or higher)
- iPad (3rd generation or higher)

## Compatible OS

- Android 5.0 or higher
- iOS 8.0 or higher

## Apps

- Health Mate® App
- Apple Health App
- Google Fit App

# Document Release Overview

---

Release date		Modifications
June 2017	v1.0	First release



**The screenshots in this manual are used for explanatory purposes. Your actual screens may differ from the screenshots in this manual.**

# Warranty

---

## Nokia® One (1) Year Limited Warranty - Nokia BPM+

Nokia® warrants the Nokia® branded hardware product (“Nokia BPM+”) against defects in materials and workmanship when used normally in accordance with Nokia®’ published guidelines for a period of ONE (1) YEAR from the date of original retail purchase by the end-user purchaser (“Warranty Period”). Nokia® published guidelines include but are not limited to information contained in technical specifications, safety instructions or quick start guide. Withings does not warrant that the operation of the Nokia BPM+ will be uninterrupted or error-free. Nokia® is not responsible for damage arising from failure to follow instructions relating to the Nokia BPM+’s use.

# Regulatory Statements

---

## Federal Communications Commission (FCC) Statement

FCC ID: XNAWPM03

This device complies with Part 15 of the FCC Rules. This equipment complies with FCC radiation exposure limits set forth for an uncontrolled environment. End users must follow the specific operating instructions for satisfying RF exposure compliance. This transmitter must not be co-located or operated in conjunction with any other antenna or transmitter.

Operation is subject to the following two conditions:

- (1) This device may not cause harmful interference, and
- (2) This device must accept any interference received, including interference that may cause undesired operation.

This device complies with the R&TTE Directive 1999/5/CE.

A copy of the EU Declaration of Conformity is available online at [nokia.com/compliance](http://nokia.com/compliance)