

HARD FLOOR EXPERT™
MULTICYCLONIC
USER GUIDE

1547 SERIES

IMPORTANT SAFETY INSTRUCTIONS

READ ALL INSTRUCTIONS BEFORE USING YOUR UPRIGHT VACUUM.

Always connect to a polarized outlet (one slot is wider than the other). Unplug from outlet when not in use and before conducting maintenance. When using an electrical appliance, basic precautions should be observed, including the following:

WARNING

TO REDUCE THE RISK OF FIRE, ELECTRIC SHOCK, OR INJURY:

- » Always connect to a polarized outlet (one slot is wider than the other). Do not modify the polarized plug to fit a non-polarized outlet or extension cord.
- » Do not leave vacuum cleaner when it is plugged in. Unplug from outlet when not in use and before servicing.
- » Do not use outdoors or on wet surfaces.
- » Do not allow to be used as a toy. Close attention is necessary when used by or near children.
- » Do not use for any purpose other than described in this User's Guide. Use only manufacturer's recommended attachments.
- » Do not use with damaged cord or plug. If appliance is not working as it should, has been dropped, damaged, left outdoors, or dropped into water, have it repaired at an authorized service center.
- » Do not pull or carry by cord, use cord as a handle, close a door on cord, or pull cord around sharp edges or corners. Do not run appliance over cord. Keep cord away from heated surfaces.
- » Do not unplug by pulling on cord. To unplug, grasp the plug, not the cord.
- » Do not handle plug or vacuum cleaner with wet hands.
- » Do not put any object into openings. Do not use with any opening blocked; keep openings free of dust, lint, hair, and anything that may reduce air flow.
- » Keep hair, loose clothing, fingers, and all parts of body away from openings and moving parts.
- » Turn off all controls before plugging or unplugging vacuum cleaner.
- » Use extra care when cleaning on stairs.
- » Do not use to pick up flammable or combustible materials (lighter fluid, gasoline, kerosene, etc.) or use in areas where they may be present.
- » Do not use vacuum cleaner in an enclosed space filled with vapors given off by oil base paint, paint thinner, some moth proofing substances, flammable dust, or other explosive or toxic vapors.
- » Do not use to pick up toxic material (chlorine bleach, ammonia, drain cleaner, etc.).
- » Do not pick up anything that is burning or smoking, such as cigarettes, matches, or hot ashes.
- » Do not use without filters in place.
- » Do not pick up hard or sharp objects such as glass, nails, screws, coins, etc.
- » Use only on dry, indoor surfaces.
- » Keep appliance on a level surface.
- » Do not carry the vacuum cleaner while it is running.
- » Unplug before connecting or disconnecting the TurboBrush® Tool.

SAVE THESE INSTRUCTIONS FOR FUTURE USE

This model is for household use only.

THIS APPLIANCE HAS A POLARIZED PLUG

To reduce the risk of electric shock, this appliance has a polarized plug (one blade is wider than the other). This plug will fit in a polarized outlet only one way. If the plug does not fit fully in the outlet, reverse the plug. If it still does not fit, contact a qualified electrician to install a proper outlet. Do not change the plug in any way.

Thanks for buying a BISSELL vacuum

We're glad you purchased a BISSELL vacuum. Everything we know about floor care went into the design and construction of this complete, high-tech home cleaning system.

Your BISSELL vacuum is well made, and we back it with a limited warranty. We also stand behind it with a knowledgeable, dedicated Consumer Care department, so, should you ever have a problem, you'll receive fast, considerate assistance.

My great-grandfather invented the floor sweeper in 1876. Today, BISSELL is a global leader in the design, manufacture, and service of high quality homecare products like your BISSELL vacuum.

Thanks again, from all of us at BISSELL.

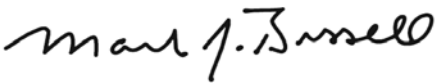

Mark J. Bissell
Chairman & CEO

Safety Instructions	2
Product View	4
Assembly	5
Operations	5-6
Maintenance & Care	6-8
Troubleshooting	9
Replacement Parts	10
Warranty	11
Service	11
Product Registration	12
Consumer Care	12



Product View

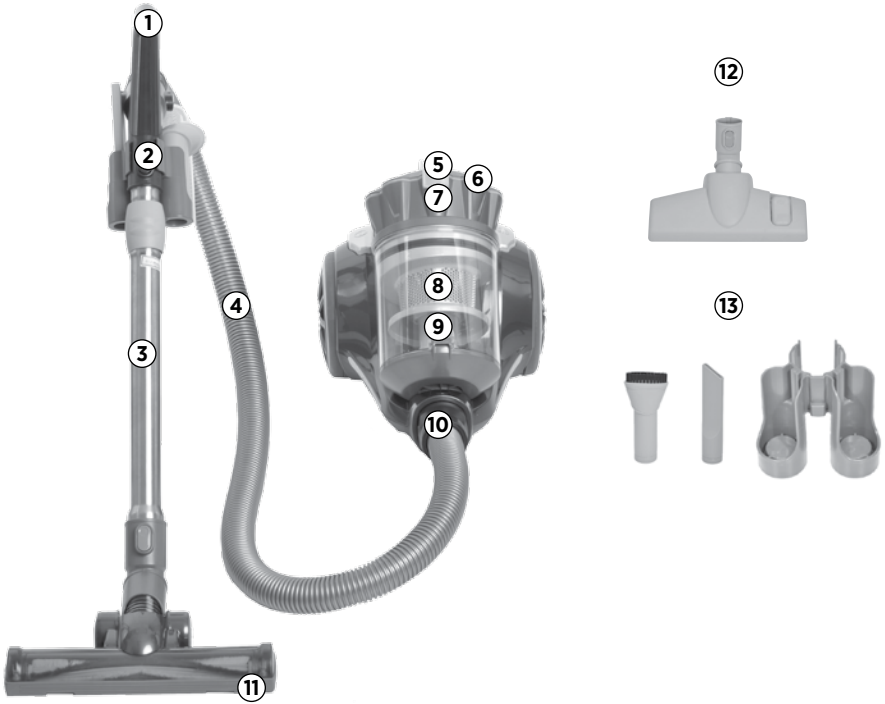

- | | | | |
|---|-------------------------|----|---|
| 1 | Handle | 8 | Cyclone |
| 2 | Air Flow Regulator | 9 | Easy Empty™ Dirt Cup |
| 3 | Extension Wand | 10 | Hose Connector |
| 4 | Hose | 11 | Turbine Hard Floor Tool |
| 5 | Carry Handle | 12 | Multi-Surface Floor Nozzle |
| 6 | Dirt Cup Release Button | 13 | Crevice Tool, Dusting Brush & Upholstery Tool w/Holster |
| 7 | Emptying Button | | |



WARNING

Plastic film can be dangerous. To avoid danger of suffocation, keep away from babies and children.



WARNING

Do not plug in your vacuum cleaner until you are familiar with all instructions and operating procedures.



WARNING

To reduce the risk of electric shock, turn power switch off and disconnect polarized plug from electrical outlet before performing maintenance or troubleshooting checks.

Assembly

1. Connect hose to vacuum by inserting hose connector on the end of the hose into the suction inlet. Make sure the hose is positioned so the tabs on the hose connector line up with the notches on the suction inlet.
2. Connect hose handle to the end of the extension wand and twist slightly to tighten.
3. Connect floor nozzle to the end of the extension wand and twist slightly to tighten.
4. Once assembled, you can store your vacuum by inserting the storage clip (located on the back of the floor nozzle) into the storage slot on the rear of the vacuum.

Colors may vary from models shown.

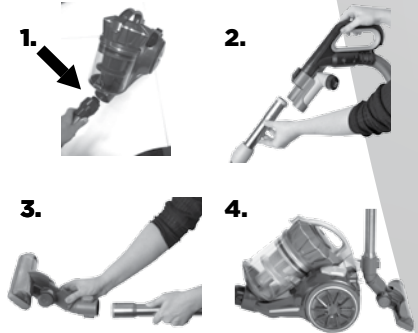

Operations

Automatic cord rewind

Your vacuum is equipped with an automatic cord rewind. When cleaning is finished, press the power button OFF and grasp the plug to disconnect from the electrical outlet. Hold the plug and press the automatic cord rewind button to rewind the cord automatically.

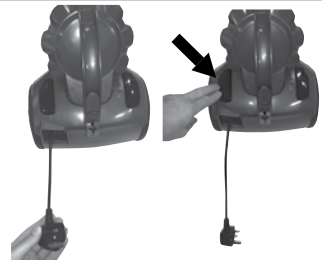

Power button

Turn the power ON or OFF by pressing lightly downward on the power button (ⓘ).





Special tools

Your BISELL vacuum is not only a powerful carpet and rug vacuum cleaner, it's also a versatile bare floor and above floor vacuum cleaner when you select one of the special tools.

Floor nozzle

Use to vacuum carpets, rugs and bare floors. Swivel head turns to get into tight spaces and fits under cabinets.

1. To vacuum carpets and rugs, push the brush switch to the carpet position . This will pull the brushes up into the floor nozzle.
2. To vacuum bare floors, push the brush switch to the bare floor position . This will extend the brushes down from the floor nozzle.



Operations

Small accessories

Use the crevice tool in tight, narrow spaces.
Use the dusting brush to clean curtains, draperies, and side tables and window ledges.
Use upholstery tool for soft furnishings.



Turbine Hard Floor Tool

Use to vacuum to vacuum, tile, wood, laminate and other hard surfaces

Air flow regulator (2)

Open the air flow regulator by sliding the regulator up towards the handle to an open position. This will reduce the suction power for vacuuming delicate fabrics.

For full suction power, close the air flow regulator by sliding the regulator down to the closed position.

Maintenance & Care

Empty the dirt cup

Empty the dirt cup as soon as the dirt reaches the "FULL" lines on the sides of the dirt cup.

1. Unplug the vacuum from the electrical outlet.
2. Press the dirt cup release button on the carry handle and lift up to remove the dirt cup.
3. Choose an emptying method. Method #2 is recommended for allergy sufferers.

Method #1 - Hold the dirt cup over a rubbish bin and push the emptying button to open the bottom. Close the bottom after the dirt empties.

Method #2 - Place a plastic bag over the bottom of the dirt cup. Push the emptying button through the plastic to open the bottom. After the dust settles, close the bottom and remove the bag to discard.

4. Replace the dirt cup by placing it back into the vacuum and pushing down on the carry handle until it snaps back into place.

WARNING

To reduce the risk of electric shock, turn power switch off and disconnect polarized plug from electrical outlet before performing maintenance or troubleshooting checks.

2.



3.

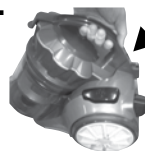

4.



Maintenance & Care

Cleaning the dirt cup filter

Use only BISSELL replacement filters in your vacuum.

1. Unplug the vacuum from the electrical outlet.
2. The dirt cup filters can be reached by removing the dirt cup from the vacuum, and unclipping the dirt cup lid then pivoting backwards. Pull filter upwards to remove.
3. The dirt cup filter can be hand washed in cold water with a mild detergent. Rinse well and air dry thoroughly before placing back onto the filter frame base.
4. Close dirt cup lid and replace dirt container back onto product.

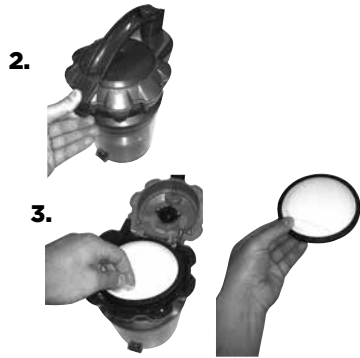

Replacing the post-motor filter

The post-motor filter assists in the filtration process to return cleaner air to the room. Use only BISSELL replacement filters.

1. Unplug the vacuum from electrical outlet.
2. Remove the filter door (located in the wheel next to the on/ off switch of the vacuum) by twisting it anti-clockwise and pulling out and away from the vacuum
3. The post-motor filter can be hand washed in cold water with a mild detergent. Rinse well and air dry thoroughly before placing back into the vacuum.
4. Replace the filter door by aligning the tabs up with the slots on inside the wheel and turning clockwise until you feel a click.

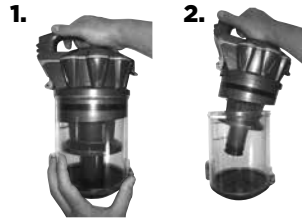

Cleaning the cyclone shroud

1. Remove the dirt cup from the dirt cup lid and cyclone assembly by twisting it anti-clockwise and pulling away.
2. Remove the cyclone shroud by twisting it clockwise then pulling down and away from the dirt tank lid, over the secondary cyclone fine dirt collector.
3. The cyclone shroud can be washed in cold water with a mild detergent. Make sure it is completely dry before replacing.
4. Replace the cyclone shroud by sliding it over the bottom of the secondary cyclone dirt collector and lining it up with the lock/ unlock arrow before twisting anti-clockwise until you feel a click.
5. Replace the dirt cup and twist clockwise to lock.

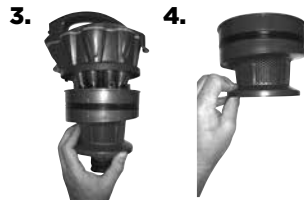

Maintenance & Care

Clearing clogs from the dirt cup

1. Unplug the vacuum from electrical outlet.
2. Remove the dirt cup from the vacuum, following steps 1-3 of Emptying the dirt cup on page 6.
3. Remove the dirt cup filter assembly from the dirt cup, following step 2 of Clean the dirt cup filter on page 6.
4. Tap the dirt cup filter assembly over a garbage container to remove any dirt or debris from the cyclone screen that surrounds the dirt cup filter.
5. Reach up into the dirt cup to clear any dirt or debris from the dirt cup.
6. Check to see if there are any clogs in the suction inlet.
7. After clearing any dirt or debris from the dirt cup, replace the dirt cup filter assembly back in the dirt cup following step 8 of Cleaning the dirt cup filter on page 6.

Removing debris from turbine hard floor tool

1. Use coin or flathead screwdriver to release the lock on the bottom of the tool to release the soft dusting brush.
2. Return the brush and replace the locking mechanism when completed.

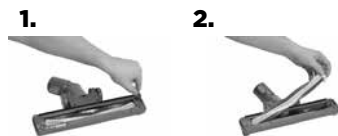

Troubleshooting



WARNING

To reduce the risk of electric shock, turn power switch off and disconnect polarized plug from electrical outlet before performing maintenance or troubleshooting checks.

Problem	Possible causes	Remedies
Vacuum cleaner won't turn on	Power cord not plugged in	Check electrical plug
	Blown fuse/tripped breaker	Check/replace fuse or reset breaker
Vacuum cleaner won't pick up dirt and/or tools are not working	Incorrect height adjustment	Adjust powerfoot to correct height setting
	Hose not attached to suction opening	Grasp the hose wand and firmly push into the hose wand base
	Crack or hole in hose	Check hose and replace if needed
	Broken or worn drive belt	Replace drive belt, see page 12
	Rotating floor brush bristles worn	Replace brush
	Rotating floor brush jammed	Remove brush and clean debris from brush ends, see page 11
	Clog in vacuum	Follow instructions on page 12 for clearing clogs
	Dirt tank full	Empty dirt tank
	Dirt tank or upper tank not installed properly	Position correctly and lock in place
Filters are dirty	Check and clean or replace pre-motor and post-motor filters, see page 8	
Weakened suction power	Full dust bin	Empty dust bin
	Dusty filter(s)	Check, clean or replace filters
	Clog in the hard floor tool or hose	Follow instructions E3 on page 6 for cleaning the hard floor tool
Power cord will not rewind	The power cord may pile on one side of the coiler	Pull out a large section of the cord and rewind it
Power cord won't pull out	Power cord may be twisted	Press the rewind button and pull out
Visible dirt escaping from cleaner	Dirt tank full	Empty dirt tank
	Filters missing or installed incorrectly	Check pre-motor and post-motor filters for correct installation

Please do not return this product to the store.

Other maintenance or service not included in the manual should be performed by an authorized service representative.









Thank you for selecting a BISSELL product.

For any questions or concerns, BISSELL is happy to be of service. Contact us directly at 1-800-237-7691.



Replacement Parts

These items are available for your BISELL vacuum.
Call 1-800-237-7691 or visit www.bissell.com

PART #	PART NAME		PART #	PART NAME	
160-5296	Post-Motor Filter		160-5295	Dirt Cup Filter	
160-3060	Dusting Brush		160-5292	Multi-Surface Floor Nozzle	
160-2331	Hose Assembly		160-2091	Telescopic Extension Wand	
160-3058	Crevice Tool		160-2090	Turbine Hard Floor Tool	
160-TBD	Handle Assembly				

Warranty

This warranty gives you specific legal rights, and you may also have other rights which may vary from state to state. If you need additional instruction regarding this warranty or have questions regarding what it may cover, please contact BISSELL Consumer Care by E-mail, telephone, or regular mail as described below.

Limited Two-Year Warranty

Subject to the *EXCEPTIONS AND EXCLUSIONS identified below, upon receipt of the product BISSELL will repair or replace (with new or remanufactured components or products), at BISSELL's option, free of charge from the date of purchase by the original purchaser, for two years any defective or malfunctioning part.

See information on "If your BISSELL product should require service".

This warranty applies to product used for personal, and not commercial or rental service. This warranty does not apply to fans or routine maintenance components such as filters, belts, or brushes. Damage or malfunction caused by negligence, abuse, neglect, unauthorized repair, or any other use not in accordance with the User's Guide is not covered.

BISSELL IS NOT LIABLE FOR INCIDENTAL OR CONSEQUENTIAL DAMAGES OF ANY NATURE ASSOCIATED WITH THE USE OF THIS PRODUCT. BISSELL'S LIABILITY WILL NOT EXCEED THE PURCHASE PRICE OF THE PRODUCT.

Some states do not allow the exclusion or limitation of incidental or consequential damages, so the above limitation or exclusion may not apply to you.

*EXCEPTIONS AND EXCLUSIONS FROM THE TERMS OF THE LIMITED WARRANTY

THIS WARRANTY IS EXCLUSIVE AND IN LIEU OF ANY OTHER WARRANTIES EITHER ORAL OR WRITTEN. ANY IMPLIED WARRANTIES WHICH MAY ARISE BY OPERATION OF LAW, INCLUDING THE IMPLIED WARRANTIES OF MERCHANTABILITY AND FITNESS FOR A PARTICULAR PURPOSE, ARE LIMITED TO THE THREE YEAR DURATION FROM THE DATE OF PURCHASE AS DESCRIBED ABOVE.

Some states do not allow limitations on how long an implied warranty last so the above limitation may not apply to you.

NOTE: Please keep your original sales receipt. It provides proof of date of purchase in the event of a warranty claim.

Service

If your BISSELL product should require service:

Visit BISSELL.com or contact BISSELL Consumer Care to locate a BISSELL Authorized Service Center in your area.

If you need information about repairs or replacement parts, or if you have questions about your warranty, contact BISSELL Consumer Care.

Website or E-mail:

www.BISSELL.com

Or Call:

BISSELL Consumer Care
1-800-237-7691

Monday - Friday 8am - 10pm ET

Saturday 9am - 8pm ET

Sunday 10am - 7pm ET



Register your product today!

Registering is quick, easy and offers you benefits over the lifetime of your product.

You'll receive:

BISSELL Rewards Points

Automatically earn points for discounts and free shipping on future purchases.

Faster Service

Supplying your information now saves you time should you need to contact us with questions regarding your product.

Product Support

Reminders and Alerts

We'll contact you with any important product maintenance reminders and alerts.

Special Promotions

Optional: Register your email to receive notice of offers, contests, cleaning tips and more!

Visit www.BISSELL.com/registration now!

BISSELL Consumer Care

For information about repairs or replacement parts, or questions about your warranty:

Call:

BISSELL Consumer Care
1-800-237-7691

Monday - Friday 8 am - 10 pm ET
Saturday 9 am - 8 pm ET
Sunday 10am - 7pm ET

Email:

BISSELL.com/email-us

Visit the BISSELL website: www.BISSELL.com

When contacting BISSELL, have model number of cleaner available.

Please record your Model Number: _____

Please record your Purchase Date: _____

NOTE: Please keep your original sales receipt. It provides proof of purchase date in the event of a warranty claim. See Warranty on page 11 for details.



©2014 BISSELL Homecare, Inc
Grand Rapids, Michigan
All rights reserved. Printed in China
Part Number 160-3879 Rev 12/14
Visit our website at: www.BISSELL.com