

### STEP 6

Install Square Leg (5) on Panel (B) with Screw (2).

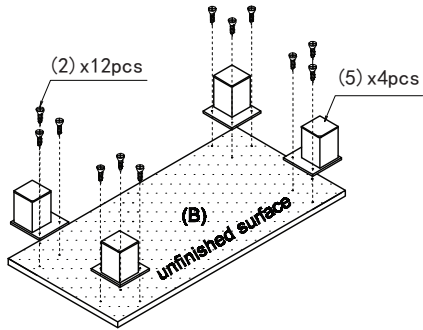

### STEP 8

Upright the unit.  
Attach Back Panel (H) to the back side with Power Pin (6).

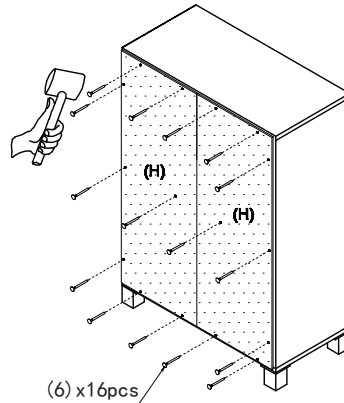

### STEP 7

Attach Bottom Panel (B) to assembled unit with Screw (1).

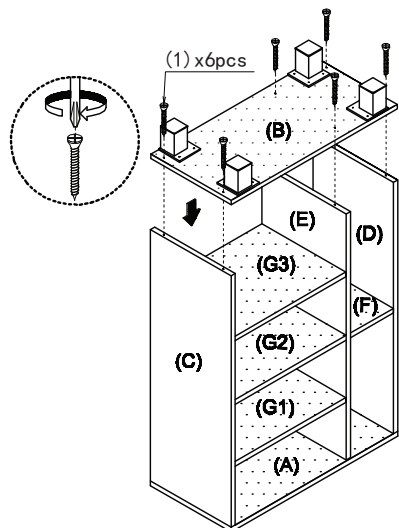

### STEP 9

Unfold the Bin (9) and slide into the storage.

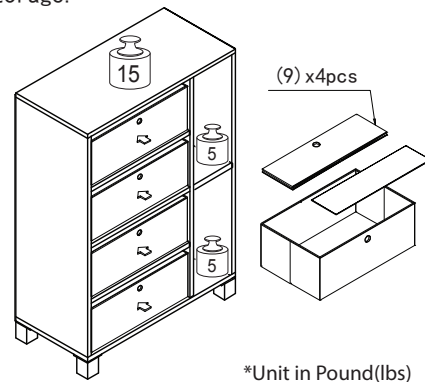

\*Unit in Pound (lbs)

#### **WARNING:**

>This unit has been designed to support the maximum loads shown. Exceeding these load limits could cause sagging, instability, product collapse, and/or serious injury.

>DO NOT allow children to climb on unit.

>Put heavier items on lower shelves.



## **Assembly Instruction**

Furinno Multipurpose Storage Cabinet with 4 Bin-Type Drawer

MODEL : **11159**

DIMENSION : 23.6"(W) x 33.1"(H) x 11.8 "(D)

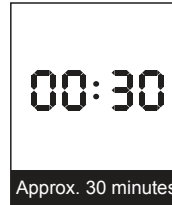

Approx. 30 minutes



Recomm. 2 Person

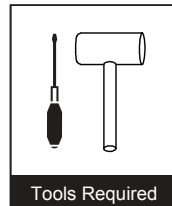

Tools Required



### Customer Service

Tel/Fax: 281.500.9372









Toll Free: 773.299.8111 (Mon - Fri 9am - 5pm)









Email: support@furinno.com

[www.furinno.com](http://www.furinno.com)

Find us on  
**Facebook**

**Pinterest**

No	Hardware List	Qty
1	Long Screw 	6pcs
2	Short Screw 	12pcs
3	Long Plastic Dowel 	2pcs
4	Short Plastic Dowel 	18pcs
5	Square Leg 	4pcs
6	Power Pin 	16pcs
7	Cam-Lock Nut 	6pcs
8	Cam-Lock Srew 	6pcs
9	Bin 	4pcs

No	Parts List	Qty
A	Top Panel 	1pcs
B	Bottom Panel 	1pcs
C	Left Side Panel 	1pcs
D	Right Side Panel 	1pcs
E	Center Panel 	1pcs
F	Short Shelf Panel 	1pcs
G	Long Shelf Panel (G1) (G2) (G3) 	3pcs
H	Back Panel 	2pcs

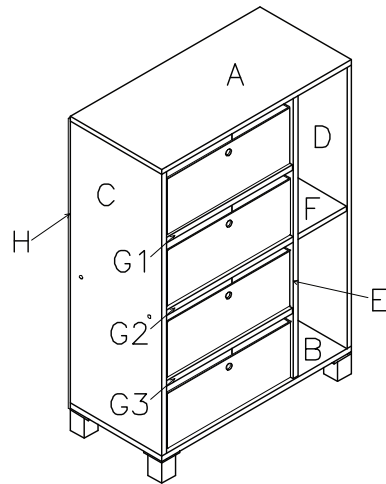

#### USEFUL HINTS BEFORE YOU START:

1. Read each step carefully before starting.
2. It is important that each step is performed in correct order to avoid difficulties.
3. Identify, sort and count the parts before assembly.
4. Assemble your furniture on packaging cardboard to prevent scratch or damage.
5. Clean the product with mild cleanser using soft damped cloth. Do not use harsh or abrasive cleanser.
6. Using incompatible hardware might cause damage to product.

#### STEP 1

Insert Dowel (4) to Panel (G1) (G2) (G3).  
Insert Dowel (3) & (4) to Panel (F).

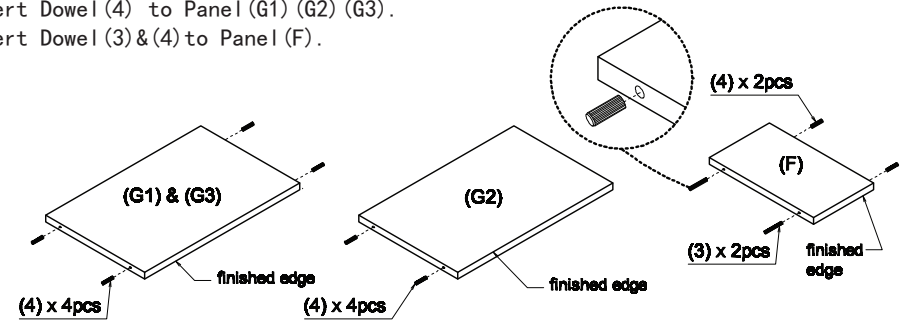

#### STEP 2

Insert Cam-Lock Nut (7) and Dowel (4) into Panel (C) (D) (E).  
\*\*Arrow on Cam-Lock Nut should be pointing toward hole.\*\*

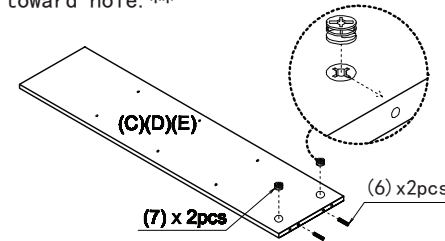

#### STEP 3

Attach Shelf Panel (G) to Panel (C) & (E).  
Attach Panel (F) to Panel (E) & (D).

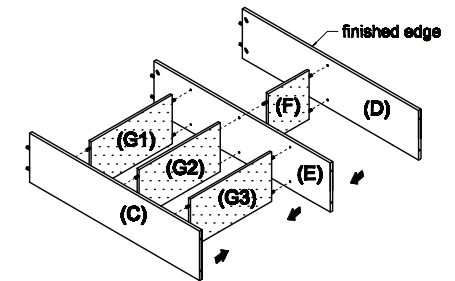

#### STEP 4

Screw Cam-Lock Screw (8) into the pre-drilled holes on Panel (A).

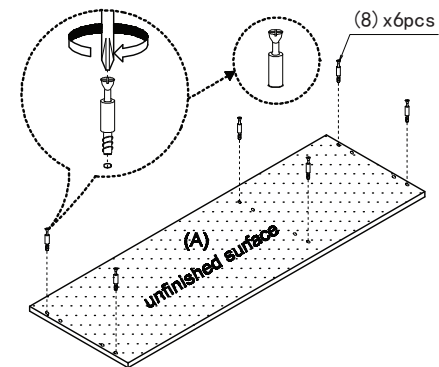

#### STEP 5

Attach assembled unit to Panel (A) and tighten Cam-Lock Nut (7) using phillips screwdriver.

