

# PORTER CABLE®

20V MAX\* 18 GAUGE CORDLESS BRAD NAILER



| Fastener Length |      | Fastener Gauge |
|-----------------|------|----------------|
| MIN.            | MAX. |                |
| 5/8"            | 2"   | 18             |
| 16mm            | 50mm | 1.2mm          |

INSTRUCTION MANUAL

## SAFETY GUIDELINES - DEFINITIONS

It is important for you to read and understand this manual. The information it contains relates to protecting YOUR SAFETY and PREVENTING PROBLEMS. The symbols below are used to help you recognize this information.

**⚠ DANGER:** Indicates an imminently hazardous situation which, if not avoided, will result in death or serious injury.

**⚠ WARNING:** *Indicates a potentially hazardous situation which, if not avoided, could result in death or serious injury.*

**⚠ CAUTION:** *Indicates a potentially hazardous situation which, if not avoided, may result in minor or moderate injury.*

**NOTICE:** *Used without the safety alert symbol indicates a situation which, if not avoided, may result in property damage.*

## General Power Tool Safety Warnings

**⚠ WARNING:** Read all safety warnings and all instructions. Failure to follow the warnings and instructions may result in electric shock, fire and/or serious injury.

### SAVE ALL WARNINGS AND INSTRUCTIONS FOR FUTURE REFERENCE

The term "power tool" in the warnings refers to your mains-operated (corded) power tool or battery-operated (cordless) power tool.

#### 1) WORK AREA SAFETY

- a) Keep work area clean and well lit. Cluttered or dark areas invite accidents.
- b) Do not operate power tools in explosive atmospheres, such as in the presence of flammable liquids, gases or dust. Power tools create sparks which may ignite the dust or fumes.
- c) Keep children and bystanders away while operating a power tool. *Distractions can cause you to lose control.*

#### 2) ELECTRICAL SAFETY

- a) Power tool plugs must match the outlet. Never modify the plug in any way. Do not use any adapter plugs with earthed (grounded) power tools. *Unmodified plugs and matching outlets will reduce risk of electric shock.*
- b) Avoid body contact with earthed or grounded surfaces such as pipes, radiators, ranges and refrigerators. *There is an increased risk of electric shock if your body is earthed or grounded.*
- c) Do not expose power tools to rain or wet conditions. *Water entering a power tool will increase the risk of electric shock.*
- d) Do not abuse the cord. Never use the cord for carrying, pulling or unplugging the power tool. Keep cord away from heat, oil, sharp edges or moving parts. *Damaged or entangled cords increase the risk of electric shock.*
- e) When operating a power tool outdoors, use an extension cord suitable for outdoor use. *Use of a cord suitable for outdoor use reduces the risk of electric shock.*
- f) If operating a power tool in a damp location is unavoidable, use a ground fault circuit interrupter (GFCI) protected supply. *Use of a GFCI reduces the risk of electric shock.*

#### 3) PERSONAL SAFETY

- a) Stay alert, watch what you are doing and use common sense when operating a power tool. Do not use a power tool while you are tired or under the influence of drugs, alcohol or medication. *A moment of inattention while operating power tools may result in serious personal injury.*
- b) Use personal protective equipment. Always wear eye protection. *Protective equipment such as dust mask, nonskid safety shoes, hard hat, or hearing protection used for appropriate conditions will reduce personal injuries.*
- c) Prevent unintentional starting. Ensure the switch is in the off position before connecting to power source and/ or battery pack, picking up or carrying the tool. *Carrying power tools with your finger on the switch or energizing power tools*

that have the switch on invites accidents.

- d) **Remove any adjusting key or wrench before turning the power tool on.** A wrench or a key left attached to a rotating part of the power tool may result in personal injury.
  - e) **Do not overreach. Keep proper footing and balance at all times.** This enables better control of the power tool in unexpected situations.
  - f) **Dress properly. Do not wear loose clothing or jewelry. Keep your hair, clothing and gloves away from moving parts.** Loose clothes, jewelry or long hair can be caught in moving parts.
  - g) **If devices are provided for the connection of dust extraction and collection facilities, ensure these are connected and properly used.** Use of dust collection can reduce dust-related hazards.
- 4) POWER TOOL USE AND CARE**
- a) **Do not force the power tool. Use the correct power tool for your application.** The correct power tool will do the job better and safer at the rate for which it was designed.
  - b) **Do not use the power tool if the switch does not turn it on and off.** Any power tool that cannot be controlled with the switch is dangerous and must be repaired.
  - c) **Disconnect the plug from the power source and/or the battery pack from the power tool before making any adjustments, changing accessories, or storing power tools.** Such preventive safety measures reduce the risk of starting the power tool accidentally.
  - d) **Store idle power tools out of the reach of children and do not allow persons unfamiliar with the power tool or these instructions to operate the power tool.** Power tools are dangerous in the hands of untrained users.
  - e) **Maintain power tools. Check for misalignment or binding of moving parts, breakage of parts and any other condition that may affect the power tool's operation.** If damaged, have the power tool repaired before use. Many accidents are caused by poorly maintained power tools.
  - f) **Keep cutting tools sharp and clean.** Properly maintained cutting tools with sharp cutting edges are less likely to bind and are easier to control.
  - g) **Use the power tool, accessories and tool bits, etc. in accordance with these instructions, taking into account the working conditions and the work to be performed.** Use of the power tool for operations different from those intended could result in a hazardous situation.

**5) BATTERY TOOL USE AND CARE**

- a) **Recharge only with the charger specified by the manufacturer.** A charger that is suitable for one type of battery pack may create a risk of fire when used with another battery pack.
- b) **Use power tools only with specifically designated battery packs.** Use of any other battery packs may create a risk of injury and fire.
- c) **When battery pack is not in use, keep it away from other metal objects, like paper clips, coins, keys, nails, screws or other small metal objects, that can make a connection from one terminal to another.** Shorting the battery terminals together may cause burns or a fire.
- d) **Under abusive conditions, liquid may be ejected from the battery, avoid contact.** If contact accidentally occurs, flush with water. If liquid contacts eyes, additionally seek medical help. Liquid ejected from the battery may cause irritation or burns.

**6) SERVICE**

- a) **Have your power tool serviced by a qualified repair person using only identical replacement parts.** This will ensure that the safety of the power tool is maintained.

**NAILER SAFETY WARNINGS**

- **Always assume that the tool contains fasteners.** Careless handling of the nailer can result in unexpected firing of fasteners and personal injury.
- **Do not point the tool towards yourself or anyone nearby.** Unexpected triggering will discharge the fastener causing an injury.
- **Do not actuate the tool unless the tool is placed firmly against the workpiece.** If the tool is not in contact with the workpiece, the fastener may be deflected away from your target.
- **Disconnect the tool from the power source when the fastener jams in the tool.** While removing a jammed fastener, the nailer may be accidentally activated if it is plugged in.

- **Do not use this nailer for fastening electrical cables.** *It is not designed for electric cable installation and may damage the insulation of electric cables thereby causing electric shock or fire hazards.*

## ADDITIONAL NAILER SAFETY WARNINGS

⚠ **WARNING:** When using any nailer, all safety precautions, as outlined below, should be followed to avoid the risk of death or serious injury. Read and understand all instructions before operating the tool.

- Hold tool by insulated gripping surfaces when performing an operation where the cutting tool may contact hidden wiring. Contact with a “live” wire will make exposed metal parts of the tool “live” and shock the operator.
- **Actuating tool may result in flying debris, collation material, or dust which could harm operator’s eyes.** Operator and others in work area **MUST** wear safety glasses with side shields. These safety glasses must conform to ANSI Z87.1 requirements (approved glasses have “Z87” printed or stamped on them. It is the employer’s responsibility to enforce the use of eye protection equipment by the tool operator and other people in the work area. (Fig. A)
- Always wear appropriate personal hearing and other protection during use. Under some conditions and duration of use, noise from this product may contribute to hearing loss. (Fig. A)
- **Disconnect battery pack from the tool when not in use. Always remove battery pack and remove fasteners from magazine before leaving the area or passing the tool to another operator.** Do not carry tool to another work area in which changing location involves the use of scaffoldings, stairs, ladders, and the like, with battery pack connected. Do not make adjustments, perform maintenance or clear jammed fasteners while battery is in place.
- Do not remove, tamper with, or otherwise cause the tool, trigger, trigger lock-off, or contact trip **to become inoperable.** Do not tape or tie trigger or contact trip in the ON position. Do not remove spring from contact trip. Make daily inspections for free movement of trigger and contact trip. Uncontrolled discharge could result.
- **Inspect tool before use.** Do not operate a tool if any portion of the tool, trigger, trigger lock-off, or contact trip is inoperable, disconnected, altered, or not working properly. Damaged parts or missing parts should be repaired or replaced before use. Refer to **Maintenance**.
- Do not alter or modify the tool in any way.
- Always assume that the tool contains fasteners.
- Do not point the tool at co-workers or yourself at any time. No horseplay! Work safe! Respect the tool as a working implement. (Fig. B)
- **Keep bystanders, children, and visitors away while operating a power tool.** Distractions can cause you to lose control. When tool is not in use, it should be locked in a safe place, out of the reach of children.
- Do not carry the tool from place to place holding the trigger. Accidental discharge could result.
- Always use trigger lock-off when tool is not in immediate use. Using the *trigger lock-off* will prevent accidental discharge.
- **Do not overreach. Maintain proper footing and balance at all times.** Loss of balance may cause personal injury. (Fig. C)



FIG. B



FIG. C



- Use the tool only for its intended use. Do not discharge fasteners into open air, concrete, stone, extremely hard woods, knots or any material too hard for the fastener to penetrate. *Do not use the body of the tool as a hammer. Discharged fasteners may follow unexpected path and cause injury.* (Figs. D, E, F)
- Refer to the *Maintenance* and *Repairs* sections for detailed information on the proper maintenance of the tool.
- **Always operate the tool in a clean, lighted area.** Be sure the work surface is clear of any debris and be careful not to lose footing when working in elevated environments such as rooftops.
- Do not drive fasteners near edge of material. The workpiece may split causing the fastener to ricochet, injuring you or a co-worker. Be aware that the nail may follow the grain of the wood (shiner), causing it to protrude unexpectedly from the side of the work material. Drive the chisel point of the nail perpendicular to the grain to reduce risk of injury. (Figs. E, F, K)
- **Do not drive nails onto the heads of other fasteners or with the tool at too steep an angle.** Personal injury from strong recoil, jammed fasteners, or ricocheted nails may result. (Fig. G)
- Always keep fingers clear of contact trip to prevent injury from inadvertent release of the pusher (Fig. H)
- Keep hands and body parts clear of immediate work area. Hold workpiece with clamps when necessary to keep hands and body out of potential harm. Be sure the workpiece is properly secured before pressing the nailer against the material. The contact trip may cause the work material to shift unexpectedly. (Fig. H)
- Do not use tool in the presence of flammable dust, gases or fumes. The tool may produce a spark that could ignite gases causing a fire. Driving a nail into another nail may also cause a spark. (Fig. I)
- Keep face and body parts away from back of the tool when working in restricted areas. Sudden recoil can result in impact to the body, especially when nailing into hard or dense material. (Fig. J)
- **Grip tool firmly to maintain control while allowing tool to recoil away from work surface as fastener is driven.**
- **Choice of triggering method is important.** Check the manual for triggering options.
- When actuating the brad nailer, always keep tool in control. Inaccurate placement of tool can result in misdirected discharge of a fastener.
- Do not drive nails onto the heads of other fasteners. Strong recoil, jammed fasteners, or ricocheted nails may result. (Fig. K)
- Be aware of material thickness when using nailer. A protruding nail may cause injury.

FIG. D

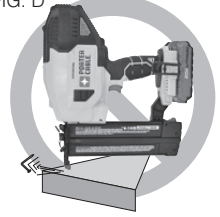

FIG. E

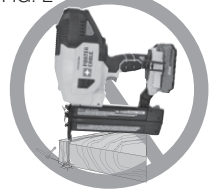

FIG. F

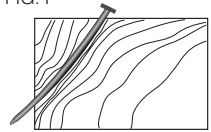

FIG. G

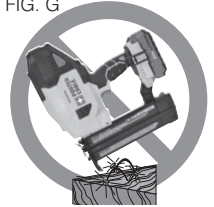

FIG. H

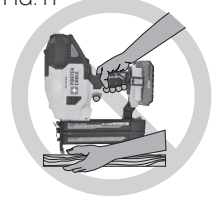
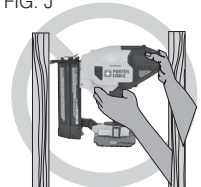

FIG. I



FIG. J



- **DEPTH ADJUSTMENT:** To reduce risk of serious injury from accidental actuation when attempting to adjust depth, **ALWAYS;**
  - Remove battery pack.
  - Engage trigger lock-off (Fig. L).
  - Avoid contact with trigger during adjustments
- Do not drive nails blindly into walls, floors or other work areas. Fasteners driven into live electrical wires, plumbing, or other types of obstructions can result in injury. (Fig. M)
- Stay alert, watch what you are doing and use common sense when operating a power tool. Do not use tool while tired or under the influence of drugs, alcohol, or medication. A moment of inattention while operating power tools may result in serious personal injury.
- Air vents often cover moving parts and should be avoided. Loose clothes, jewelry or long hair can be caught in moving parts.

FIG. K



FIG. L



FIG. M

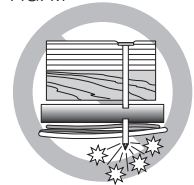

**⚠ WARNING:** ALWAYS use safety glasses. Everyday eyeglasses are NOT safety glasses. Also use face or dust mask if operation is dusty. **ALWAYS WEAR CERTIFIED SAFETY EQUIPMENT:**

- ANSI Z87.1 eye protection (CAN/CSA Z94.3),
- ANSI S12.6 (S3.19) hearing protection,
- NIOSH/OSHA/MSHA respiratory protection.

**⚠ WARNING:** Some dust created by power sanding, sawing, grinding, drilling, and other construction activities contains chemicals known to the State of California to cause cancer, birth defects or other reproductive harm. Some examples of these chemicals are:

- lead from lead-based paints,
- crystalline silica from bricks and cement and other masonry products, and
- arsenic and chromium from chemically-treated lumber.

Your risk from these exposures varies, depending on how often you do this type of work. To reduce your exposure to these chemicals: work in a well ventilated area, and work with approved safety equipment, such as those dust masks that are specially designed to filter out microscopic particles.

- Avoid prolonged contact with dust from power sanding, sawing, grinding, drilling, and other construction activities. Wear protective clothing and wash exposed areas with soap and water. Allowing dust to get into your mouth, eyes, or lay on the skin may promote absorption of harmful chemicals.

**⚠ WARNING:** Use of this tool can generate and/or disperse dust, which may cause serious and permanent respiratory or other injury. Always use NIOSH/OSHA approved respiratory protection appropriate for the dust exposure. Direct particles away from face and body.

**⚠ WARNING:** Always wear proper personal hearing protection that conforms to ANSI S12.6 (S3.19) during use. Under some conditions and duration of use, noise from this product may contribute to hearing loss.

**⚠ CAUTION:** When not in use, place tool on its side on a stable surface where it will not cause a tripping or falling hazard. Some tools with large battery packs will stand upright on the battery pack but may be easily knocked over.

- The label on your tool may include the following symbols. The symbols and their definitions are as follows:
 

|   |  |
|---|--|
| <p>V .....volts</p> <p>Hz .....hertz</p> <p>min .....minutes</p> <p>— or DC ....direct current</p> <p>ⓘ .....Class I Construction<br/>(grounded)</p> <p>▣ .....Class II Construction<br/>(double insulated)</p> <p>.../min .....per minute</p> <p>IPM .....impacts per minute</p> <p>SPM .....strokes per minute</p> <p>📖 .....<i>Read instruction manual before use</i></p> <p>👁 .....<i>Use proper eye protection</i></p> | <p>A ..... amperes</p> <p>W ..... watts</p> <p>~ or AC ..... alternating current</p> <p>⌚ or AC/DC .... alternating or direct current</p> <p>⊖ ..... no load speed</p> <p>n ..... rated speed</p> <p>⊕ ..... earthing terminal</p> <p>⚠ ..... safety alert symbol</p> <p>BPM .....beats per minute</p> <p>RPM ..... revolutions per minute</p> <p>sfpm ..... surface feet per minute</p> <p>🧴 .....<i>Use proper respiratory protection</i></p> <p>👂 .....<i>Use proper hearing protection</i></p> |
|---|--|

## IMPORTANT SAFETY INSTRUCTIONS FOR BATTERY CHARGERS

**SAVE THESE INSTRUCTIONS:** This manual contains important safety instructions for battery chargers.

**⚠ WARNING:** Before using charger, read all instructions and cautionary markings on charger, battery pack, and product using battery pack.

- **Shock hazard.** Do not allow any liquid to get inside charger.
- **Burn hazard.** To reduce the risk of injury, charge only designated **PORTER-CABLE** batteries. Other types of batteries may burst causing personal injury and damage.
- Under certain conditions, with the charger plugged in to the power supply, the charger can be shorted by foreign material. Foreign materials of a conductive nature such as, but not limited to, steel wool, aluminum foil, or any buildup of metallic particles should be kept away from charger cavities. Always unplug the charger from the power supply when there is no battery pack in the cavity. Unplug charger before attempting to clean.
- **DO NOT attempt to charge the battery pack with any chargers other than the ones in this manual.** *The charger and battery pack are specifically designed to work together.*
- **These chargers are not intended for any uses other than charging designated PORTER-CABLE rechargeable batteries.** *Any other uses may result in risk of fire, electric shock or electrocution.*
- **Do not expose charger to rain or snow.**
- **Pull by plug rather than cord when disconnecting charger.** *This will reduce risk of damage to electric plug and cord.*
- **Make sure that cord is located so that it will not be stepped on, tripped over, or otherwise subjected to damage or stress.**
- **Do not use an extension cord unless it is absolutely necessary.** *Use of improper extension cord could result in risk of fire, electric shock, or electrocution.*
- **An extension cord must have adequate wire size (AWG or American Wire Gauge) for safety.** *The smaller the gauge number of the wire, the greater the capacity of the cable, that is 16 gauge has more capacity than 18 gauge. When using more than one extension to make up the total length, be sure each individual extension contains at least the minimum wire size.*
- **Do not place any object on top of charger or place the charger on a soft surface that might block the ventilation slots and result in excessive internal heat. Place the charger in a position away from any heat source.** *The charger is ventilated through slots in the top and the bottom of the housing.*
- **Do not operate charger with damaged cord or plug — have them replaced immediately.**
- **Do not operate charger if it has received a sharp blow, been dropped, or otherwise damaged in any way.** *Take it to an authorized service center.*
- **Do not disassemble charger; take it to an authorized service center when service or repair is required.** *Incorrect reassembly may result in a risk of electric shock, electrocution or fire.*

- **Disconnect the charger from the outlet before attempting any cleaning.** This will reduce the risk of electric shock. Removing the battery pack will not reduce this risk.
- **NEVER attempt to connect 2 chargers together.**
- **The charger is designed to operate on standard household electrical power (120 Volts). Do not attempt to use it on any other voltage.**

## SAVE THESE INSTRUCTIONS

### IMPORTANT SAFETY INSTRUCTIONS FOR BATTERY PACKS

**⚠WARNING:** For safe operation, read this manual and manuals originally supplied with tool before using the charger.

The battery pack is not fully charged out of the carton. Before using the battery pack and charger, read the safety instructions below. Then follow charging procedures outlined.

### READ ALL INSTRUCTIONS

- **Do not incinerate the battery pack even if it is severely damaged or is completely worn out.** The battery pack can explode in a fire. Toxic fumes and materials are created when LI-ION battery packs are burned.
- **Do not charge or use battery in explosive atmospheres, such as in the presence of flammable liquids, gases or dust.** Inserting or removing the battery from the charger may ignite the dust or fumes.
- **If battery contents come into contact with the skin, immediately wash area with mild soap and water.** If battery liquid gets into the eye, rinse water over the open eye for 15 minutes or until irritation ceases. If medical attention is needed, the battery electrolyte for Li-ion batteries is composed of a mixture of liquid organic carbonates and lithium salts.
- **Contents of opened battery cells may cause respiratory irritation.** Provide fresh air. If symptoms persists, seek medical attention.

**⚠WARNING: Burn hazard.** Battery liquid may be flammable if exposed to spark or flame.

- Charge the battery packs only in **PORTER-CABLE** chargers.
- **DO NOT splash or immerse in water or other liquids.** This may cause premature cell failure.
- **Do not store or use the tool and battery pack in locations where the temperature may reach or exceed 105°F (40°C) (such as outside sheds or metal buildings in summer).**

**⚠WARNING:** Never attempt to open the battery pack for any reason. If battery pack case is cracked or damaged, do not insert into charger. Do not crush, drop or damage battery pack. Do not use a battery pack or charger that has received a sharp blow, been dropped, run over or damaged in any way (i.e., pierced with a nail, hit with a hammer, stepped on). Damaged battery packs should be returned to service center for recycling.

**⚠WARNING: Fire hazard.** Do not store or carry battery so that metal objects can contact exposed battery terminals. For example, do not place battery in aprons, pockets, tool boxes, product kit boxes, drawers, etc., with loose nails, screws, keys, etc. Transporting batteries can possibly cause fires if the battery terminals inadvertently come in contact with conductive materials such as keys, coins, hand tools and the like. The US Department of Transportation Hazardous Material Regulations (HMR) actually prohibit transporting batteries in commerce or on airplanes (i.e., packed in suitcases and carry-on luggage) UNLESS they are properly protected from short circuits. So when transporting individual batteries, make sure that the battery terminals are protected and well insulated from materials that could contact them and cause a short circuit.

**NOTE: LI-ION batteries should not be put in checked baggage.**

- When using an extension cord, be sure to use one heavy enough to carry the current your product will draw. An undersized cord will cause a drop in line voltage resulting in loss of power and overheating. The following table shows the correct size to use depending on cord length and nameplate ampere rating. If in doubt, use the next heavier gage. The smaller the gage number, the heavier the cord.

#### Recommended Minimum Wire Size for Extension Cords

| Total Length of Cord |        |        |         |         |         |         |
|----------------------|--------|--------|---------|---------|---------|---------|
| 25 ft.               | 50 ft. | 75 ft. | 100 ft. | 125 ft. | 150 ft. | 175 ft. |
| 7.6 m                | 15.2 m | 22.9 m | 30.5 m  | 38.1 m  | 45.7 m  | 53.3 m  |
| Wire Size AWG        |        |        |         |         |         |         |
| 18                   | 18     | 16     | 16      | 14      | 14      | 12      |

## STORAGE RECOMMENDATIONS

1. The best storage place is one that is cool and dry away from direct sunlight and excess heat or cold.
2. Long storage will not harm the battery pack or charger.

## CHARGING PROCEDURE

**PORTER-CABLE** chargers are designed to charge **PORTER-CABLE** battery packs. Charge times are: PCC690L and PCC692L in 35-100 mins., PCC691L in 65-200 mins. and PCC695L in 160-300 mins. depending on the pack being charged.

1. Plug the charger into an appropriate outlet before inserting the battery pack.
2. Insert the battery pack into the charger.

 3. The LED will flash indicating that the battery is being charged.

4. The completion of charge is indicated by the LED remaining on continuously.

 The pack is fully charged and may be used at this time or left on the charger.  
**Recharge discharged batteries as soon as possible after use or battery life may be greatly diminished. For longest battery life, do not discharge batteries fully.** It is recommended that the batteries be recharged after each use.

## CHARGER DIAGNOSTICS

This charger is designed to detect certain problems that can arise with the battery packs or the power source. Problems are indicated by one LED flashing in different patterns.

### BAD BATTERY

 The charger can detect a weak or damaged battery. The LED flashes in the pattern indicated on the label. If you see this bad battery blink pattern, do not continue to charge the battery. Return it to a service center or a collection site for recycling.

### HOT/COLD PACK DELAY

 When the charger detects a battery that is excessively hot or excessively cold, it automatically starts a Hot/Cold Pack Delay, suspending charging until the battery has normalized. After this happens, the charger automatically switches to the Pack Charging mode. This feature ensures maximum battery life. The light flashes in the pattern indicated on the label.

### PROBLEM POWER LINE

 When the charger is used with some portable power sources such as generators or sources that convert DC to AC, the charger may temporarily suspend operation. The LED flashes in the pattern indicated on the label. This indicates that the power source is out of limits.

### LEAVING THE BATTERY IN THE CHARGER

The charger and battery pack can be left connected with the LED glowing indefinitely. The charger will keep the battery pack fresh and fully charged. This charger features an automatic tune-up mode which equals or balances the individual cells in the battery pack to allow it to function at peak capacity. Battery packs should be tuned up weekly or whenever the battery no longer delivers the same amount of work. To use the automatic tune-up mode, place the battery pack in the charger and leave it for at least 8 hours.

### IMPORTANT CHARGING NOTES

1. Longest life and best performance can be obtained if the battery pack is charged when the air temperature is between 65°F and 75°F (18° - 24°C). DO NOT charge the battery pack in an air temperature below +40°F (+4.5°C), or above +105°F (+40.5°C). This is important and will prevent serious damage to the battery pack.
2. The charger and battery pack may become warm to touch while charging. This is a normal condition, and does not indicate a problem. To facilitate the cooling of the battery pack after use, avoid placing the charger or battery pack in a warm environment such as in a metal shed, or an uninsulated trailer.
3. If the battery pack does not charge properly:
  - a. Check current at receptacle by plugging in a lamp or other appliance
  - b. Check to see if receptacle is connected to a light switch which turns power off when you turn out the lights.
  - c. Move charger and battery pack to a location where the surrounding air temperature is approximately 65°F - 75°F (18° - 24°C).
  - d. If charging problems persist, take the tool, battery pack and charger to your local service center.
4. The battery pack should be recharged when it fails to produce sufficient power on jobs which were easily done previously. DO NOT CONTINUE to use under these conditions. Follow the charging procedure. You may also charge a partially used pack whenever you desire with no adverse affect on the battery pack.

## FUNCTIONAL DESCRIPTION

Figure 1

1. Trigger Switch
2. Trigger Lock-Off switch
3. Depth adjustment wheel
4. Depth adjustment indicator
5. Worklights/low battery/jam indicator

6. Stall release lever
7. Jam clearing latch
8. Contact trip
9. Magazine
10. Pusher latch
11. Hang hook

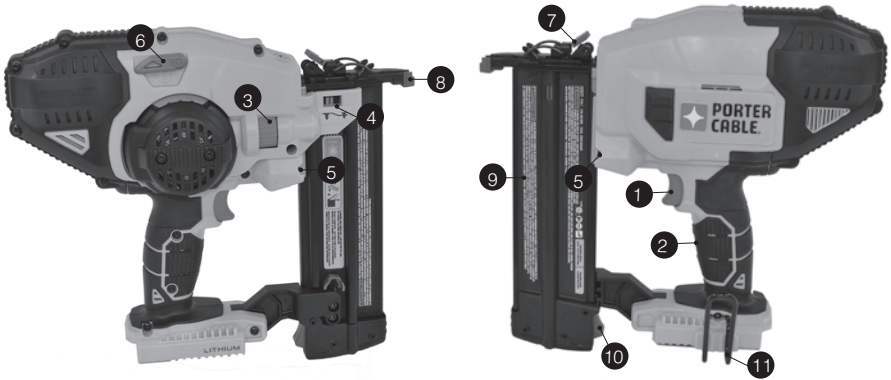

This product uses the batteries and chargers listed below.

20V Max\* Lithium-Ion Batteries: PCC680L, PCC681L, PCC685L, PCC682L

20V Max\* Lithium-Ion Chargers: PCC690L, PCC691L, PCC695L, PCC692L

## OPERATING INSTRUCTIONS

### INSTALLING AND REMOVING THE BATTERY PACK FROM THE TOOL

**⚠WARNING:** Make certain the trigger lock-off button is engaged to prevent switch actuation before removing or installing battery.

**TO INSTALL BATTERY PACK:** Insert battery pack (2A) firmly into tool until an audible click is heard as shown in **Figure 2**. Ensure battery pack is fully seated and fully latched into position.

**TO REMOVE BATTERY PACK:** Depress the battery release button (3A) as shown in **Figure 3** and pull battery pack out of tool.

### OPERATION

**⚠WARNING:** Read the section titled **Nailer Safety Warnings** at the beginning of this manual. Always wear eye and ear protection when operating this tool. Keep the nailer pointed away from yourself and others. For safe operation, complete the following procedures and checks before each use of the nailer.

**⚠WARNING:** To reduce the risk of personal injury, disconnect battery pack from tool and engage trigger lock-off before performing maintenance, clearing a jammed nails, leaving work area, moving tool to another location or handing the tool to another person.

**⚠WARNING:** Always wear proper eye [ANSI Z87.1 (CAN/CSA Z94.3)] and ANSI S12.6 (S3.19) hearing protection when operating tool.

This **PORTER-CABLE** cordless nailer is assembled in accordance with the ANSI Standard SNT-101-2002.

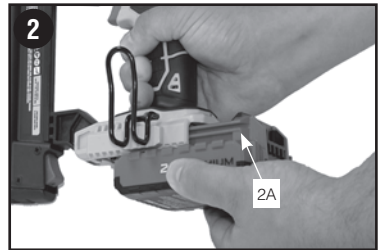

**⚠WARNING:** *Keep fingers AWAY from trigger when not driving fasteners to avoid accidental firing.* NEVER carry tool with finger on trigger.

1. Wear proper eye, hearing and respiratory protection.
2. Remove battery pack from tool and engage trigger lock-off.
3. Lock the pusher in the back position and remove all nail strips from the magazine.
4. Check for smooth and proper operation of contact trip and pusher assemblies. Do not use tool if either assembly is not functioning properly.
5. NEVER use a tool that has damaged parts.

## TO OPERATE THE NAILER

**⚠WARNING:** The contact trip needs to be depressed followed by a full trigger pull for each nail followed by a release of both the contact trip and trigger after each nail.

**⚠WARNING:** The battery should always be removed and the trigger lock-off engaged whenever any adjustments are made or when tool is not in use.

1. Fully depress contact trip against the work surface.
2. Fully pull trigger and motor will start. (nail will drive into work surface).
3. Release trigger.
4. Lift contact trip off work surface.
5. Repeat steps 1 through 4 for next application.

## PREPARING THE TOOL

**⚠WARNING:** NEVER spray or in any other way apply oil, lubricants or cleaning solvents inside the tool. *This can seriously affect the life and performance of the tool.*

**⚠WARNING:** The battery should always be removed and the trigger lock-off engaged whenever any adjustments are made or when tool is not in use.

1. **Read the Safety Instruction section of this manual.**
2. Wear eye and ear protection.
3. Remove battery from tool and fully charge.
4. Ensure magazine is empty of all fasteners.
5. Check for smooth and proper operation of contact trip and pusher assemblies. Do not use tool if either assembly is not functioning properly.
6. Keep tool pointed away from yourself and others.
7. Insert fully charged battery pack.

## LOADING THE TOOL

**⚠WARNING:** Keep the tool pointed away from yourself and others. Serious personal injury may result.

**⚠WARNING:** Never load nails with the contact trip or trigger activated. Personal injury may result.

**⚠WARNING:** Always remove battery pack before loading or unloading nails. Serious personal injury may result.

**⚠WARNING:** The battery should always be removed and the trigger lock-off is engaged whenever any adjustments are made or when tool is not in use.

**⚠CAUTION:** Keep fingers clear of pusher to prevent injury.

1. Press pusher latch (10) and pull magazine down.
2. Insert fasteners into the side of the magazine. Ensure the fastener tips are placed towards the front of the magazine, under the nail guide (4A) in the nail channel **as shown in figure 4**.
3. Push magazine closed until it locks into place.

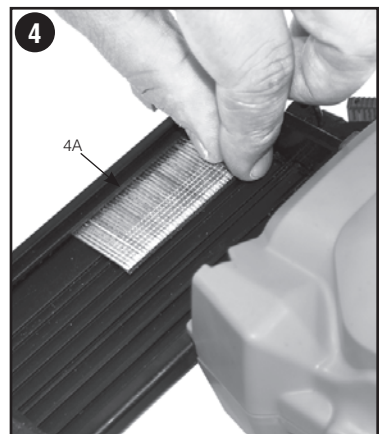

## UNLOADING THE TOOL

**⚠WARNING:** The battery should always be removed and the trigger lock-off engaged whenever any adjustments are made or when tool is not in use.

1. Press the nail pusher latch and pull the magazine down.
2. Tip the tool up until the nails slide freely out of the magazine.
3. Open the jam clear door on the contact trip to verify there are no nails remaining.

## ADJUSTING DEPTH (FIG. 5)

The depth that the fastener is driven can be adjusted using the depth adjustment wheel (3) on the side of the tool.

**⚠WARNING:** *To reduce risk of serious injury from accidental actuation when attempting to adjust depth, ALWAYS:*

- Remove battery pack.
- Engage trigger lock-off.
- Avoid contact with trigger during adjustments.

Depth settings are on a sliding scale, the right side being the shallowest and the left side being the deepest.

1. To drive the nail shallower, rotate the depth adjustment wheel (3) to the lowest setting, towards the right on the depth adjustment indicator (4).
2. To drive the nail deeper, rotate the depth adjustment wheel (3) to the highest setting, towards the left on the depth adjustment indicator (4).

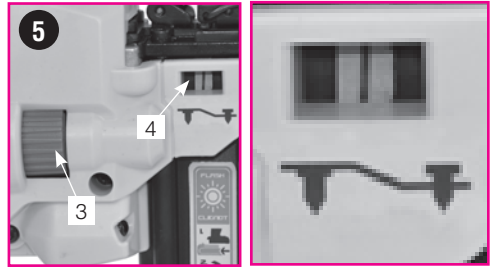

## WORK LIGHTS (FIG. 6)

There are work lights (5) located on each side of the nailer. Work lights turn on upon depressing the contact trip.

**NOTE:** These work lights are for illuminating the immediate work surface and are not intended to be used as flashlights.

**LOW BATTERY INDICATOR:** The work lights will flash and then turn off completely to indicate low battery.

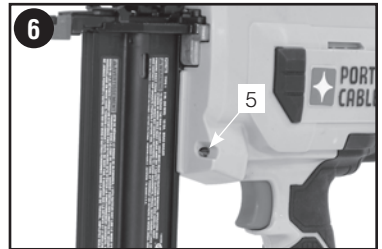

**LOW BATTERY.....** ■■■■

**JAMMED NAIL INDICATOR:** The work lights will flash continually if a nail becomes jammed in the nose piece (see **Clearing a jammed nail**).

**JAMMED NAIL .....** ■■■■■■■■■■■■

## STALL RELEASE (FIG. 7)

**⚠WARNING:** *If a jam occurs, the tool will disable itself and will require you to reset it. To do so, follow instructions on clearing the jammed nail. Next remove battery pack and then reinsert battery pack. The tool will now be operational.*

If the nailer is used in rigorous application where all available energy in the motor is used to drive a fastener, the tool may stall. The driver blade did not complete the drive cycle and the jam/stall indicator will flash. Rotate the stall release lever (6) on the tool and the mechanism will release as shown in **figure 7**.

**NOTE:** The tool will disable itself and not reset until the battery pack has been removed and reinserted. If the driver blade does not automatically return to the home position, proceed to **“clearing a jammed nail”**. If the unit continues to stall please review the material and fastener length to be sure that it is not too rigorous an application.

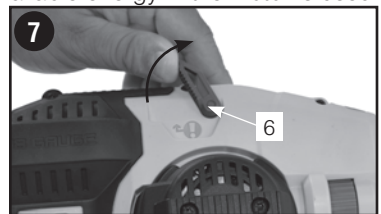

## CLEARING A JAMMED NAIL (FIG. 8)

**⚠WARNING:** To reduce the risk of personal injury, disconnect battery pack from tool and engage trigger lock-off before performing maintenance, or clearing a jammed nail. If a nail becomes jammed in the nose piece, keep the tool pointed away from you and follow these instructions to clear:

1. Remove battery pack from tool and engage trigger lock-off.
2. Rotate the stall release lever (6) on the tool to release the driver blade and clear the jam. If tool is still jammed follow steps 3-12 listed below.
3. Press the nail pusher latch (10) and pull the magazine (9) downward.
4. Tip the tool up until the nails slide freely out of the magazine.
5. Lift the jam clearing latch (7) then pull up to open front door (12).
6. Remove bent nail, using pliers if necessary.
7. If driver blade is in the down position, insert screwdriver or other rod into contact trip and push driver blade back in position.
8. Close the front door and engage the wire form (13) under the 2 arms on the contact trip. Push latch down (7) until it locks in place.
9. Reinsert nails into magazine (see **Loading the Tool**).
10. Push magazine closed until it locks into position.
11. Reinsert battery pack.
12. Disengage trigger lock-off (2), allowing the trigger to be actuated.

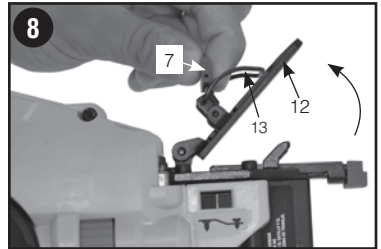

**⚠WARNING:** If a jam occurs, the tool will disable itself and will require you to reset it. To do so, follow instructions on clearing the jammed nail. Next remove battery pack and then reinsert battery pack. The tool will now be operational.

**NOTE:** Should nails continue to jam frequently in contact trip, have tool serviced by an authorized **PORTER-CABLE** service center.

## COLD WEATHER OPERATION

When operating tools at temperatures below freezing:

1. Keep tool as warm as possible prior to use.
2. Actuate the tool 5 or 6 times into scrap lumber before using.

## HOT WEATHER OPERATION

Tool should operate normally. However, keep tool out of direct sunlight as excessive heat can deteriorate bumpers and other rubber parts resulting in increased maintenance.

## HANG HOOK (FIG. 9-10)

**⚠WARNING:** Remove nails from magazine before making any adjustments or servicing this tool. Failure to do so may result in serious injury.

**⚠WARNING:** To reduce the risk of serious personal injury, disconnect battery pack from tool before making any adjustments, changing accessories, servicing, or moving the tool. Such preventative safety measures reduce the risk of starting the tool accidentally.

**⚠CAUTION:** When not in use, place tool on its side on a stable surface where it will not cause a tripping or falling hazard. Some tools with large battery packs will stand upright on the battery pack but may be easily knocked over.

The **PORTER-CABLE** cordless nailers include a hang hook (11) for convenient access and storage during use.

## TO INSTALL HANG HOOK

**⚠WARNING:** The battery should always be removed and the trigger lock-off engaged whenever any adjustments are made or when tool is not in use.

1. Remove battery pack from tool, and engage trigger lock-off.
2. With a screwdriver remove screw from hang hook cavity on the base of the tool (14).
3. Place the front lip of the hang hook (11) into the cavity on the base of the tool (14) as shown in **Figure 9**.
4. Secure the hang hook (11) with the supplied screw (15) and firmly tighten with a screwdriver as shown in **Figure 10**.
5. Replace battery pack.

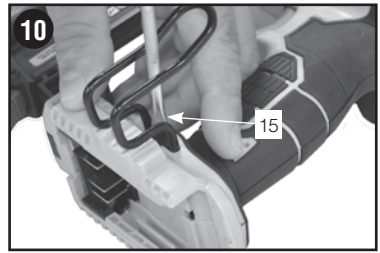
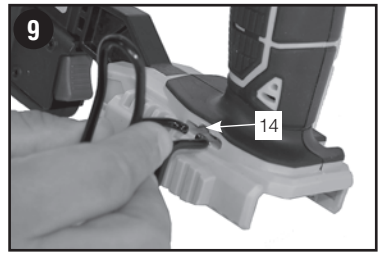

## MAINTENANCE

**⚠WARNING:** To reduce the risk of injury, turn unit off, engage trigger lock-off and remove battery before installing and removing accessories, before adjusting or when making repairs. An accidental start-up can cause injury.

### Daily Maintenance Chart

|                |   |
|----------------|---|
| <b>ACTION:</b> | Clean magazine, pusher, and contact trip mechanism.   |
| <b>WHY:</b>    | Permits smooth operation of magazine, reduces wear, and prevents jams.  |
| <b>HOW:</b>    | Clean tool with a clean, damp cloth. Do not oil or lubricate this tool. The use of oils, lubricants periodically or solvents is not recommended as they tend to attract debris. |



## CLEANING

**⚠WARNING:** Blow dirt and dust out of all air vents with clean, dry air at least once a week. To minimize the risk of eye injury, always wear ANSI Z87.1 approved eye protection when performing this.

**⚠WARNING:** Never use solvents or other harsh chemicals for cleaning the non-metallic parts of the tool. These chemicals may weaken the plastic materials used in these parts. Use a cloth dampened only with water and mild soap. Never let any liquid get inside the tool; never immerse any part of the tool into a liquid.

## LUBRICATION

**⚠WARNING:** NEVER *spray or in any other way apply lubricants or cleaning solvents inside the tool.* This can seriously affect the life and performance of the tool.

**PORTER-CABLE** tools are properly lubricated at the factory and are ready for use. However, it is recommended that, once a year, you take or send the tool to a certified **PORTER-CABLE** service center for a thorough cleaning and inspection.

## REPLACEMENT PARTS

**⚠WARNING:** To reduce the risk of personal injury, disconnect battery pack from tool and engage trigger lock-off before performing maintenance, or clearing a jammed nail. The tool comes equipped with a spare no mar tip (16) located on the side of the nail magazine as shown in **Figure 11**.

1. To replace the tip, simply pull off the old tip and slide the new tip onto the contact trip as shown in **Figure 12**.

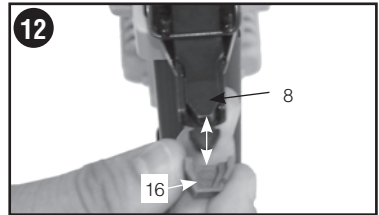
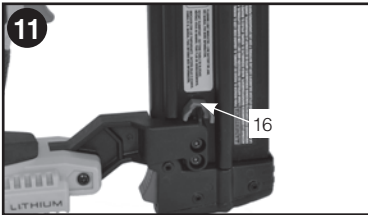

# TROUBLESHOOTING

| <u>Problem</u>   | <u>Possible Cause</u>   | <u>Possible Solution</u>   |
|--|---|--|
| - Unit will not start.   | - Battery pack not installed properly.<br>- Battery pack not charged.   | - Check battery pack installation.<br>- Check battery pack charging requirements.<br>- Disengage trigger lock-off.   |
| - Tool doesn't actuate.<br>(Headlights on, motor does not run)                 | - Motor stops running after 2 seconds.  | - Normal operation; release trigger or contact trip and re-depress.  |
| - Tool doesn't actuate.<br>(Headlights flash)                                  | - Low battery charge or damaged battery.  | - Charge or replace battery.   |
| - Tool doesn't actuate.<br>(Headlights flash continuously)                     | - Jammed fastener.<br><br>- Jammed mechanism.   | - Remove the battery, rotate the stall release lever. Clear the jammed fastener, and reinsert battery pack.<br>- See authorized service center.  |
| - Tool doesn't actuate.<br>(Headlights on, motor runs)                         | - Jammed fastener.  | - Remove the battery, rotate the stall release lever. Clear the jammed fastener, and reinsert battery pack.<br><br>- See authorized service center.  |
| - Tool doesn't actuate<br>(Headlights on, motor runs, driver blade stuck down) |   |  |
| - Tool operates, but does not drive the fastener fully.                        | - Low battery charge or damaged battery.<br>- Depth adjustment set too shallow.<br>- Tool not firmly applied to workpiece.<br>- Material and fastener length too rigorous an application. | - Charge or replace battery.<br><br>- Rotate depth adjustment wheel to a deeper setting.<br>- Read instruction manual.<br><br>- Choose appropriate material or fastener length.  |
| - Tool operates, but no fastener driven.                                       | - No fasteners in magazine.<br>- Wrong size or angle fasteners.<br><br>- Debris in contact trip or magazine.<br>- Jammed fastener.  | - Load fasteners into magazine.<br>- Use only recommended fasteners.<br>- Remove debris.<br><br>- Read "Clearing a Jammed Nail".   |
| - Jammed fastener.   | - Wrong size or angle fasteners.<br>- Material and fastener length too rigorous an application.<br>- Low battery charge or damaged battery.<br>- Debris in nose piece or magazine.        | - Use only recommended fasteners.<br><br>- Charge or replace battery.<br><br>- Remove debris.  |
| - Battery pack will not charge.  | - Battery pack not inserted into charger.<br>- Charger not plugged in.<br><br>- Surrounding air temperature too hot or too cold.  | - Insert battery pack into charger until LED lights.<br>- Plug charger into a working outlet. Refer to "Important Charging Notes" for more details.<br>- Move charger and battery pack to a surrounding air temperature of above 40 degrees F (4,5°C) or below 105 degrees F (+40,5°C) |
| - Unit shuts off abruptly.   | - Battery pack has reached its maximum thermal limit.<br>- Out of charge. ( To maximize the life of the battery pack it is designed to shutoff abruptly when the charge is depleted.)     | - Allow battery pack to cool down.<br><br>- Place on charger and allow to charge.  |