

# BIG BOSS™ JUICER



BIG BOSS™ JUICER ITEM NO. 8123E  
Distributed By EMSON® NY, NY, 10001 ©Copyright 2010  
EMSON® All Rights Reserved. Printed In China.

## **INSTRUCTION MANUAL**

Please read all instructions carefully  
and retain for future reference.



## TROUBLESHOOTING

Below information summarizes the most common problems you could encounter with your juice extractor. Please read the different sections for more details. If you are unable to solve the problem, please contact your customer care center.

PROBLEM	SOLUTIONS
The appliance does not work	The appliance is equipped with a safety system. It won't work if the parts have not been assembled properly. Switch off the appliance before checking whether the parts have been assembled in the right way.
The motor unit gives off an unpleasant smell the first few times the appliance is used	This is not unusual. If the appliance continues to give off the unpleasant smell after a few times, check the quantities you are processing and the processing time.
The appliance makes a lot of noise, gives off an unpleasant smell, is too hot to touch, emits smoke etc.	Switch the appliance off and unplug it. Bring to the nearest service center or your dealer for assistance.
The filter is blocked	Switch the appliance off, clean the feeding tube and the filter and process a smaller quantity.
The filter touches the feeding tube or vibrates strongly during processing	Switch the appliance off and unplug it. Check if the filter has been properly placed in the juice collector. The ribs in the bottom of the filter should fit properly onto the driving shaft. Check if the filter is damaged. Cracks, crazes, a loose grating disc or any other irregularity may cause malfunction.

## TIPS

1. Use fresh fruit and vegetables, as they contain more juice. Pineapples, beetroots, celery stalks, apples, cucumbers, carrots, spinach, melons, tomatoes, pomegranates, oranges and grapes are particularly suitable for processing in the juice extractor.
2. You don't have to remove thin peels or skins. Only thick peels, e.g. those of oranges, pineapples and uncooked beetroots need to be removed.
3. When preparing apple juice, remember that the thickness of the apple juice depends on the kind of apple you are using. The juicer the apple, the thinner the juice. Choose a kind of apple that produces the type of juice you prefer.
4. Apple juice turns brown very quickly. You can slow down this process by adding a few drops of lemon juice.
5. Fruits that contain starch, such as bananas, papayas, avocados, figs and mangoes are not suitable for processing in the juice extractor. Use a food processor, blender or bar blender to process these fruits.
6. Leaves and leaf stalks of e.g. lettuce can also be processed in the juice extractor.
7. Drink the juice immediately after you have extracted it. If it is exposed to air for some time, the juice will lose its taste and nutritional value.
8. To extract the maximum amount of juice, always press the pusher down slowly.
9. The juicer is not suitable for processing very hard and /or fibrous/starchy fruit or vegetables such as sugar cane.

## CLEANING

The appliance is easier to clean if you do so immediately after use.

Do not use abrasive cleaning agents, scorers, acetone, alcohol etc. to clean the appliance.

All detachable parts are dishwasher-safe.

Place the detachable plastic parts on the top tray of the dishwasher. Make sure they are placed well away from the heating element.

1. Switch the appliance off, remove the plug from the wall socket and wait until the filter has stopped rotating.
2. Remove the dirty parts from the motor unit. Disassemble the appliance in the following order:
  - a. Remove the pulp container
  - b. Remove the pusher;
  - c. Open the clamp;
  - d. Remove the lid.
3. Remove the juice collector together with the filter. See **Fig.9**.
4. Clean these parts with a cleaning brush in warm water with some washing-up liquid and rinse them under the tap. See **Fig.10**.
5. Clean the motor unit with a damp cloth.  
Never immerse the motor unit in water nor rinse it under the tap.

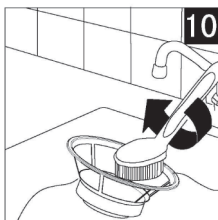
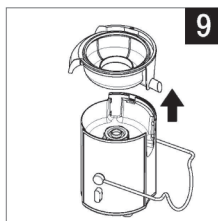

## FOR HOUSEHOLD USE ONLY IMPORTANT SAFEGUARDS

Signal Word Definitions

**DANGER** – Indicates an imminently hazardous situation, which, if not avoided, will result in death or serious injury. Usage of this signal word is limited to the most extreme situations.

**WARNING** – Indicates a potentially hazardous situation, which, if not avoided, could result in death or serious injury.

**CAUTION** – Indicates a potentially hazardous situation, which, if not avoided, may result in minor/moderate injury or product/property damage. It also alerts against unsafe practices. When using this or any other electrical appliance, always follow these basic safety precautions:

**READ ALL INSTRUCTIONS BEFORE USE.**

**WARNING: To reduce the risk of fire, electric shock, or serious personal injury:**

- Always ensure the product is unplugged from the electrical outlet before relocating, assembling, disassembling, or cleaning it.
- Keep the product out of the reach of children and pets. This product is not intended for use by children.
- Do not leave the product unattended while it is in use, especially when children are present. Always unplug the product from the electrical outlet when it is not in use.
- Do not place product base in or expose it to water or other liquids.
- Keep the power cord and product away from heated surfaces.
- Do not use attachments not recommended or sold by the product manufacturer.
- Only use the appliance when safety clamps are locked.
- Do not operate the juicer for more than 40 seconds at a time when juicing heavy loads and let it cool down sufficiently afterwards.
- Never reach into the feeding tube with your fingers or an object while the appliance is running. Only the pusher is to be used for this purpose.
- Only unlock the clamps after you have switched the appliance off and the filter has stopped rotating.
- Do not remove the pulp container when the appliance is in operation.
- Do not touch the small cutting blades in the base of the filter.
- Do not plug/unplug the product into/from the electrical outlet with a wet hand.
- To disconnect the product from an electrical outlet, pull directly on the plug; do not pull on the power cord.
- Always operate the product with the cover in place.
- Do not put any stress on the power cord where it connects to the product, as the power cord could fray and break.
- Do not operate the product if it has a damaged or cut power cord or plug, if wires are exposed, if it malfunctions, or if it is dropped or damaged. This product has no user-serviceable parts. Do not attempt to examine or repair this product yourself. Only qualified service personnel should perform any servicing; take the product to the appliance repair shop of your choice for inspection and repair.

**CAUTION: To reduce the risk of personal injury or product/property damage:**

- This product is intended for indoor, non-commercial, non-industrial use in processing foods for human consumption. Do not use the product outdoors or for any other purpose.
- Always operate the product on a flat, stable surface.
- Do not attempt to open any part of the motor housing.
- Do not allow the power cord to hang, such as over the edge of a table or counter, where it may be tripped over or pulled.

**SPECIAL INSTRUCTIONS:**

- To avoid a circuit overload when using this product, do not operate another high-wattage product on the same electrical circuit.
- Avoid the use of an extension cord because the extension cord may overheat increasing the risk of fire. However if an extension cord must be used, rated not less than 1875W.

**SAVE THESE INSTRUCTIONS FOR FUTURE REFERENCE**

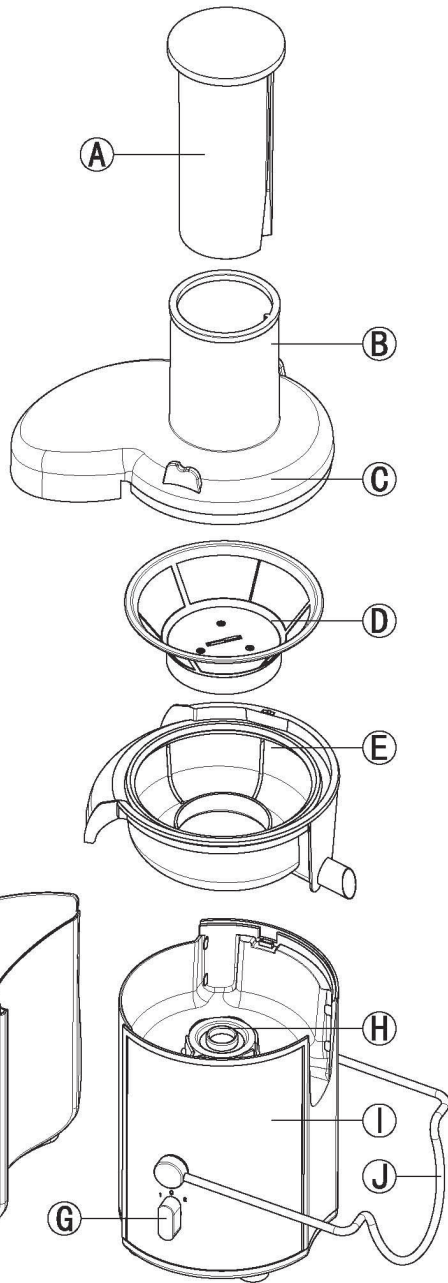

- A. Pusher**
- B. Feeding tube**
- C. Lid**
- D. Filter**
- E. Juice collector**
- F. Pulp container**
- G. Control knob**
- H. Driving shaft**
- I. Motor unit**
- J. Safety clamp**

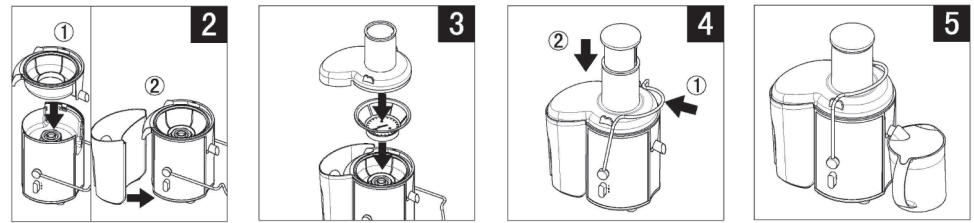

### PREPARING FOR USE

1. Wash all detachable parts (see p.5 for 'Cleaning').
2. Put the plug in the wall socket.
3. Place the juice collector into the appliance (1) and place the pulp container into the appliance by tilting it forward slightly (2). Insert the top end first and then push the bottom end. See **Fig.2**.
4. Put the filter in the juice collector (1) and hold the lid over the filter and lower it into position (2). See **Fig. 3**.
5. Snap the safety clamp onto the lid to lock it into place ('click') (1) and slide the pusher into the feeding tube by aligning the groove in the pusher with the small protrusion on the inside of the feeding tube (2). See **Fig. 4**. Make sure the safety clamps are locked into the position on either side of the lid.
6. Place the container under the spout. See **Fig. 5**.

### USING THE APPLIANCE

The appliance will only function if all parts have been properly assembled and the lid has been properly locked in place with the clamp.

1. Wash the fruit and/or vegetables and cut them into pieces that fit into the feeding tube. See **Fig. 6**.

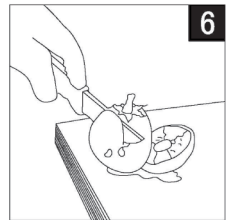

2. Make sure the container has been placed under the spout.

3. Switch the appliance on by turning the control knob to setting 1 (low speed) or 2 (normal speed). See **Fig. 7**.

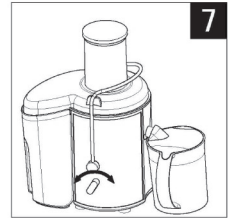

**Speed 1** is especially suitable for soft fruits and vegetables such as watermelons, grapes, tomatoes, cucumbers and raspberries.

**Speed 2** is suitable for all kinds of fruits and vegetables.

4. Put the pre-cut pieces in the feeding tube and gently press them down towards the rotating filter with the pusher. See **Fig. 8**.

Do not place too much pressure on the pusher, as this could affect the quality of the end result and it could cause the filter to come to a halt. Never insert your fingers or an object into the feeding tube.

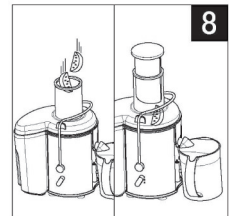

5. After you have processed all ingredients and the juice flow has stopped, switch the appliance off and wait until the filter has stopped rotating.

**NOTE:** To help complete and stop the flow of the juice, lift pusher out.