



Victure

User Manual

VD300

Video Doorbell

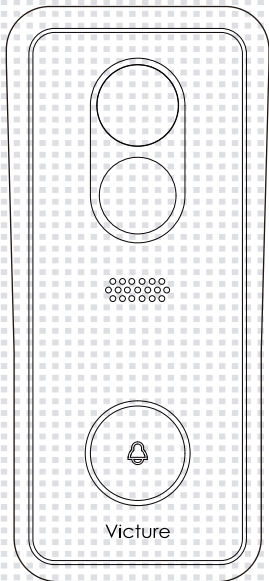

Warranty

Send us your Order Screenshot with email

vd.support@govicture.com to extend the warranty to **24 months!**

Lifetime professional tech support is provided by Victure.

Prefer Video?

Visit our YouTube Channel **'Victure VD'** for the instructional videos. You could also visit the link below for our YouTube Channel:

<https://bit.ly/2U19RXQ>

Explore More

vd.support@govicture.com



[Victure VD](#)



www.govicture.com



[Victure](#)



Contents

Package Content -----	4
Meet the Doorbell and Chime -----	5
Preparation -----	7
In-app Setup -----	10
Physical Installation -----	14
Pair with the Chime -----	17
Using your Doorbell -----	20
Troubleshooting -----	23
Need Help? -----	24
FCC Certification Information -----	25

Package Content

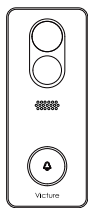

①

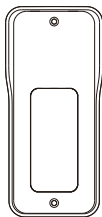

②

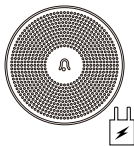

③

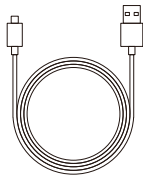

④



⑤

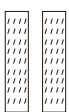

⑥

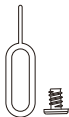

⑦



⑧

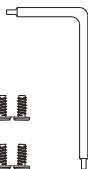

⑨

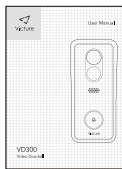

⑩

① VD300 Doorbell

② Mounting Bracket

③ Wireless Door Chime Set

④ USB Cable

⑤ Batteries

⑥ Double-sided Tape

⑦ Reset Pin & Security Screw

⑧ Screws

⑨ Screwdriver

⑩ User Manual

Meet the Doorbell and Chime

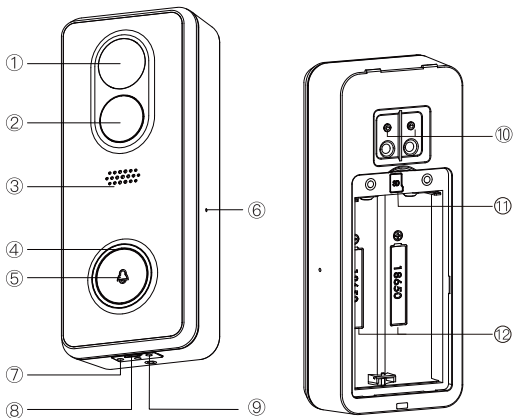

① Camera

② PIR motion Sensor

③ Speakers

④ Status Indicator

⑤ Doorbell Button

⑥ Microphone

⑦ Charging Indicator

⑧ Micro USB Port

⑨ Reset Hole

⑩ Hard-wired Power Port

⑪ SD Card Slot

⑫ Battery Compartment

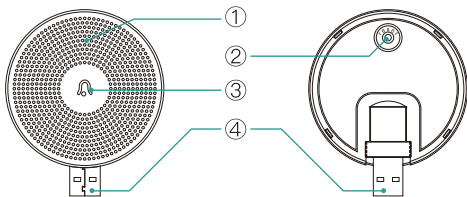

- 1. Speakers
- 3. LED Indicator

- 2. Reset Button
- 4. USB Power Port

Preparation

Insert the SD card

1. Take out the mounting bracket by pushing from the back of the doorbell.

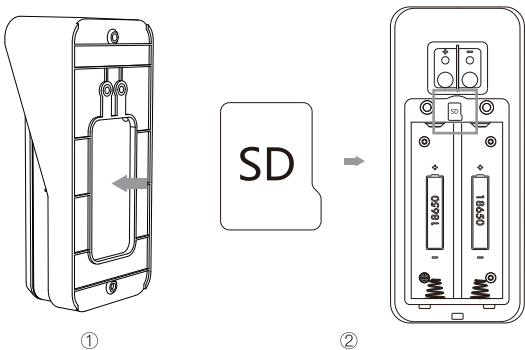

2. Unscrew the battery compartment lid with the supplied screwdriver.
3. Insert the Micro SD card to the SD card slot.

▲ Tip: Doorbell supports class 10 micro SD card from 8G to 128G. Please format the SD card with 'FAT32' format before use. Insert the SD card without powering the camera.

Insert the battery

Place the new battery in the battery compartment with correct polarity, and tighten the lid of the battery compartment securely with screws.

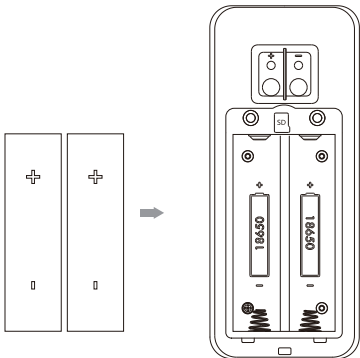

▲Tip: Please make sure the lid of the battery compartment is tightened with screws, so that there won't be any water leakage issue.

Charge your Victure doorbell

Charge the doorbell before installation using the provided USB cable. The small charging indicator next to the USB port will glow blue once fully charged.

If you can't wait to play with your doorbell, go ahead and set it up. But, we recommend fully charging it for about 8-10 hours before installation.

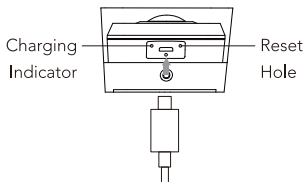

▲ Tip: The battery life of a doorbell system is affected by the amount of activation (such as traffic or population density of the neighborhood) .

In-app Setup

Download the App

The **CloudEdge** app will walk you through setting up and manage your Victure Video Doorbell. Please search '**CloudEdge**' in the Apple Store or Google Play. You could also download the app by scanning the QR code to download the app.



CloudEdge



ios



Android

Grab Your Wi-Fi Password for **2.4GHz Network**,
It's required for the in-app setup. Write it
down below so it's handy when you need it.

Your Wi-Fi password ↗

Set up your VD300 near your router

▲ Tip:

- 1). Doorbell currently supports 2.4 GHz Wi-Fi network only (5G is not supported).
- 2). Wi-Fi password does not include special characters such as @% and

3). Please move your Wi-Fi router closer to your door or invest in a Wi-Fi extender for stronger Wi-Fi signal and better video quality.

1. Register or Log in with Existing Account.

In the CloudEdge app, please register a new account with your **email address** or log in with an existing account.

▲ Tip: You will need the verification code for your email address during the account registration process. If you could not find the code in your email inbox, please check your spam folder or another tab of your email. You could also try to use a new email.

2. Add doorbell

Please tap the '+' icon to add the device.

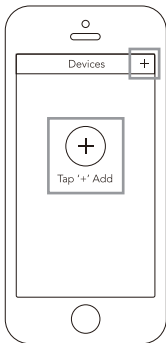

When prompted, select 'doorbell' and choose VD300 doorbell.

3. Reset the doorbell and tear off the protective film:

When switching or connecting to a new network for the doorbell, please perform a hard reset on your doorbell by inserting the reset pin into the Reset Hole of the doorbell and hold for 5 seconds to reset the doorbell and pair with the cell phone. You will hear a sound, and the status indicator turns to be flash red when the reset is done.



Tear off the protective film from the doorbell's shell and follow the in-app instruction to pair the doorbell with the app.

4. Doorbell status indicator guide

Action	Light Ring
Pairing mode	Slow blinking red
Connecting to Wi-Fi	Fast blinking red
Doorbell Error or Network Error	Solid red
Doorbell Wi-Fi connected and function properly	Solid Blue

▲ Tip:

1. Please adjust the angle and the distance between the doorbell and the cell phone slowly to make sure the doorbell is paired successfully.

2. If you could not pair the doorbell with your app, please check whether your network is 2.4GHz and the make sure the network signal is strong.

Try it out!

After setup, push the button on the front of your Victure Doorbell to see video from the camera in the CloudEdge app.

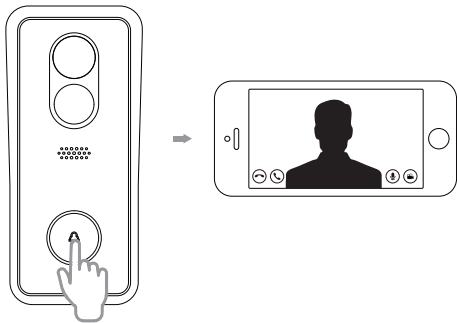

▲ Tip:

1. The camera should be connected with your phone via Wi-Fi for the first time. After that, you could see the video in the app with the cellular data.
2. If video quality is not as good outdoors as it was indoors, you may need to move your router closer to your door or invest in a Wi-Fi extender. Email our warranty team to learn more about it.

Physical Installation

Installation Method 1: Powered by Wire

Please purchase our additional hard-wire installation package, which includes the power kit to ensure that your doorbell gets the power it needs safely. Email our warranty team for more information and surprise about it.

Installation Method 2: Powered by Battery

Select an install height

Install your doorbell four feet off the ground for optimal performance.

If you are installing your Victure doorbell in a house with siding or in a house where the door is atop a set of stairs, please purchase the additional wedge mount to angle your doorbell down.

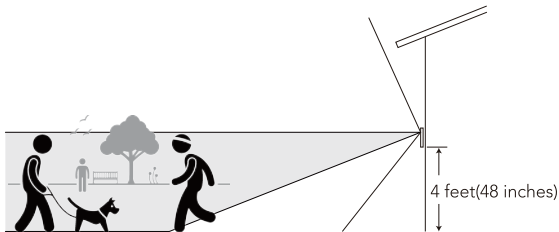

Install the mounting bracket

1. Take out the mounting bracket by pushing the doorbell from its back.

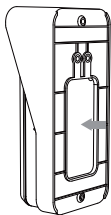

2. Mark the place to install the screws.

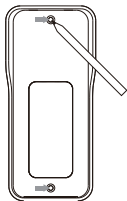

3. Insert anchors (optional)

▲ Tip: If you're installing on the hard surface such as stucco, brick, or concrete, mark the drill holes. Use the bit to drill holes in your wall and insert the anchors. If you're installing on wood, skip this step and throw the anchors in that drawer of stuff you never use.

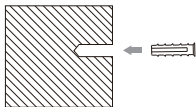

4. Use the screws to install the mounting bracket on the wall. Please drive the screws into the anchors or directly into the wall until they're flush with the mounting bracket and the bracket is flat against the wall.

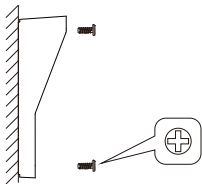

5. Attach the doorbell and secure with the security screw

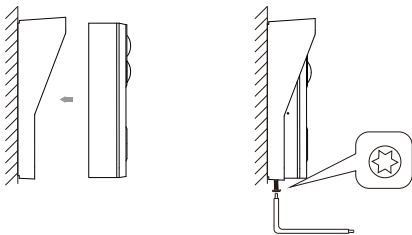

▲ Tip: If you would like to take out the doorbell, please make ensure to unscrew the security screw and take out the doorbell from the lower part of the doorbell.

Pair with the Chime

Find a location somewhere between your Wi-Fi router, and your Victure video doorbell. The chime can be powered by an USB compatible phone charger (DC5V 1A). You can also plug the chime to the USB port on your PC/notebook to supply power.

1. Power by DC5V adapter

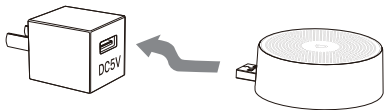

2. Power by PC's USB Port

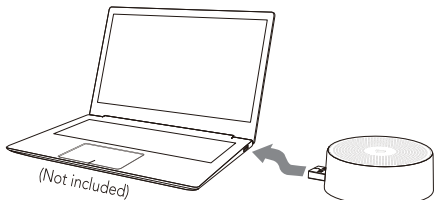

Perform the in-app Setup

When the LED Indicator on the front of your Chime is solid blue, it is ready to be set up.

1. Open the "CloudEdge" app and tap on the "... " icon to enter into Settings. Select Wireless Chime. Tap on the bell icon to go to the pairing interface.

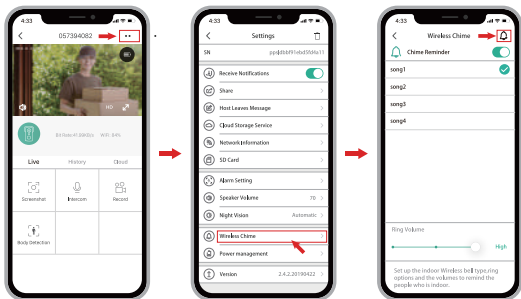

2. Reset the Chime: Hold the 'RESET' button on the back of Chime for about 5 seconds, until the LED Indicator flashes blue, indicating the device is in pairing mode.

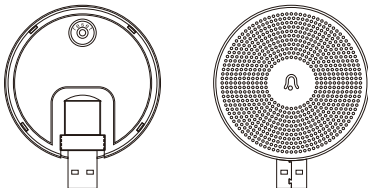

3. Tap “Pair” in the APP, and the doorbell will send a pairing signal to the Chime. Pairing succeeds, and the Indicator on the Chime will be in solid blue. Then you can push the doorbell button to try it out!

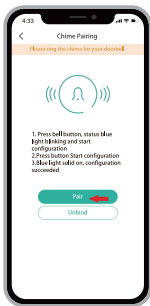

Unbound

1. Press and hold the reset button on the Chime for about 5 seconds till the Indicator flashes blue twice. It will reset to the factory default.
2. You can also tap on “unbound” (See to picture 6) in the APP to disconnect the Chime from the doorbell.

Enjoy your Chime

The LED Indicator on the front of Chime uses light patterns to communicate messages.

Flashing blue: pairing mode

Solid blue: power on/ pairing succeed

Flashes blue twice: reset to the factory setting

Using your Doorbell

In the CloudEdge app, tap your Victure doorbell to view its settings. Here you could configure your doorbell to meet your needs.

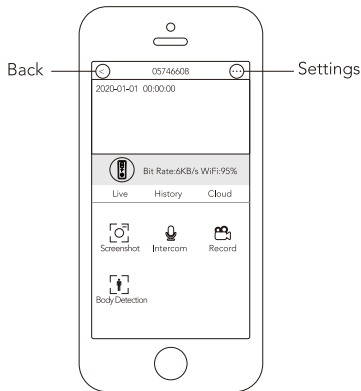

 **Intercom**—speak to visitors and hear what they have to say.

 **Body Detection**—enable to actively detect the movement with PIR sensor.

 **Screenshot/Record**—Take a live Screenshot or Video when you would like to catch the moment.

History where you could replay the recordings and check the alarms with timeline playback.

Automatic Power-Saving Mode when the doorbell does not detect anything for a long time. You could re-activate and control the doorbell remotely with your CloudEdge app.

* Switch these functions on or off on this screen.

Answering your doorbell

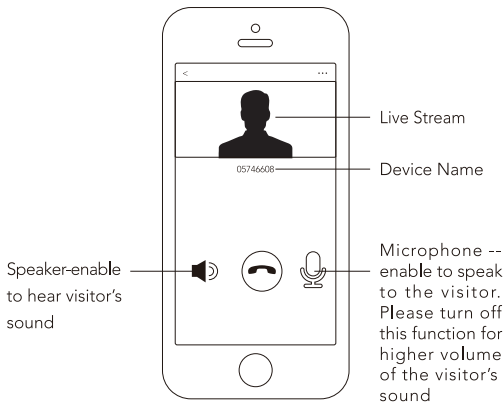

Settings



- **Device Share**—let family or friends answer live events and view recordings by adding the user account as a friend and selecting the user to share. (The shared user needs to approve your friend’s request in the message section before you could share the device.)
- **Host Leaves Message**— quick prerecorded response if you are busy and refuse to answer the call.
- **Cloud Storage Service**—an extra subscription fee will be charged if you would like to store the recordings in the cloud.
- **SD Card** —format the SD card before use. This doorbell features the loop recording technique for the SD card.
- **Alarm Setting**—adjust the sensitivity of the motion sensor for the detection range.

- **Speaker Volume**—adjust the volume of the visitor's sound. For higher visitor's sound volume, you could mute the microphone function.
- **Night Vision**— view the crisp images no matter day or night. The external light source will be recommended for better night vision quality.
- **Wireless Chime**—pair with our optional chime. Contact our warranty team for the discount of this accessory.

Troubleshooting

Q: I've installed my doorbell, but it won't turn on?

A: Please ensure that the doorbell has enough power. If you power the doorbell with wires, please make sure to connect power kit properly, and the connected power is 12V-24V AC. If all the things have been checked, but you're still not getting enough power, you may need to bypass your internal doorbell.

Q: I cannot connect the doorbell to my Wi-Fi network?

A: Tips

- 1) Doorbell currently supports 2.4 GHz Wi-Fi network only (5G is not supported). Make sure the Wi-Fi network is not an unencrypted (open) network.
- 2) Wi-Fi password does not include special characters such as @% and *.
- 3) Move your Wi-Fi router closer to the door or invest in a Wi-Fi extender for a stronger Wi-Fi signal.
- 4) Test your Wi-Fi network with other devices such as your phone or smart TV to make sure it is operating properly.
- 5) Reset the doorbell before pairing with the app. Make sure the doorbell is in pairing mode. Follow the on-screen pairing instructions

carefully and don't skip any steps.

6) Check whether your Wi-Fi router is using MAC filtering. If you cannot disable MAC filtering, you will need to add the doorbell's MAC address to the router's white-list of allowed devices. You can find the doorbell's MAC address printed on a label at the back of the device.

Need Help?

For questions, support, or warranty claims, contact us at the address below or visit govicture.com. Please include your Amazon order number and product model number.

vd.support@govicture.com

FCC Certification Information

Warning:

Changes or modifications to this unit not expressly approved by the party responsible for compliance could void the user's authority to operate the equipment.

▲Tip:

This device complies with part 15 of the FCC Rules. Operation is subject to the following two conditions: (1) This device may not cause harmful interference, and (2) this device must accept any interference received, including interference that may cause undesired operation.

▲Tip:

This equipment has been tested and found to comply with the limits for a Class B digital device, pursuant to part 15 of the FCC Rules. These limits are designed to provide reasonable protection against harmful interference in a residential installation. This equipment generates, uses and can radiate radio frequency energy and, if not installed and used in accordance with the instructions, may cause harmful interference to radio communications. However, there is no guarantee that interference will not occur in a particular installation. If this equipment does cause harmful interference to radio or television reception, which can be determined by turning the equipment off and on, the user is encouraged to try to correct the interference by one or more of the following measures:

- Reorient or relocate the receiving antenna.
- Increase the separation between the equipment and receiver.

- Connect the equipment into an outlet on a circuit different from that to which the receiver is connected.
- Consult the dealer or an experienced radio/TV technician for help.

RF exposure compliance statement:

This device has been evaluated to meet the general RF exposure requirement, it can be used in portable exposure condition without restriction.



Made in China
Version 1.0

封面封底 :120g金太阳双胶覆亚膜

内 页 :80g 金太阳双胶

尺 寸 :89mm*119mm 出血裁掉

装订方式 :钉装