



USER MANUAL

EasyCool Portable MPF

Rated voltage: 115V
Rated power: 900 - 1575W
Frequency: 60Hz
Capacity: 8000 ~ 14000BTU/h

Warning notices: Before using this product, please read this manual carefully and keep it for future reference.

The design and specifications are subject to change without prior notice for product improvement. Consult with your dealer or manufacturer for details.

version A - 03 - 2017

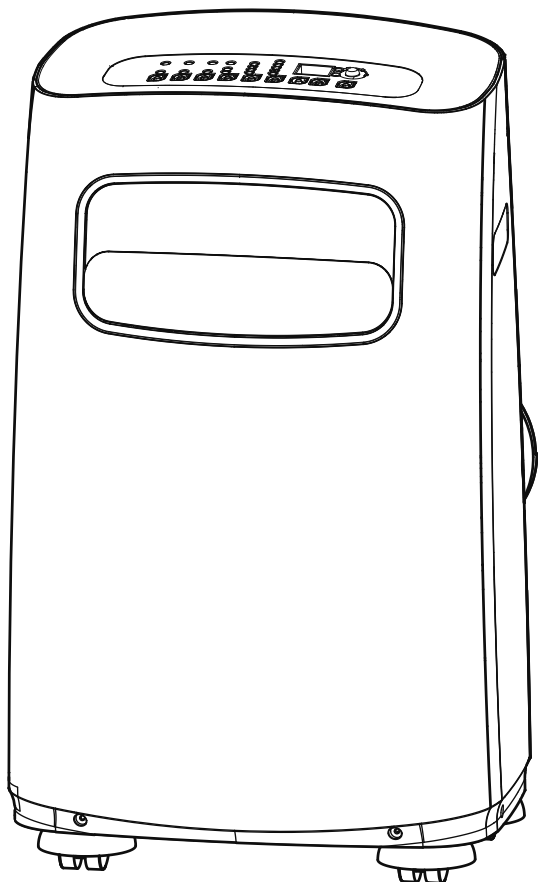

MPF08CR71
MPF10CR71
MPF12CR71
MPF14CR71

www.midea.com

0	Safety Precautions	3
1	Unit Specifications and Features	5
2	Operating Instructions	7
3	Installation Instructions	12
4	Care and Cleaning	17
5	Troubleshooting Tips	18
6	Remote Control Operating Instructions	19
7	Sociable Remark	28
8	Warranty	29

Read This Manual

Inside you will find many helpful hints on how to use and maintain your air conditioner properly. Just a little preventive care on your part can save you a great deal of time and money over the life of your air conditioner. You'll find many answers to common problems in the chart of troubleshooting tips - you should be able to fix most of them quickly before calling service. These instructions may not cover every possible condition of use, so common sense and care for safety is required when installing, operating and maintaining this product.



CAUTION

- Contact the authorized service technician for repair or maintenance of this unit.
- Contact the installer for installation of this unit.
- The air conditioner is not intended for use by young children or infirm persons without supervision.
- Young children should be supervised to ensure that they do not play with the air conditioner.
- If the power cord needs to be replaced, please contact our consumer service and look for an authorized technician.
- Electrical installation must be performed in accordance to national regulation standards by qualified personnel only.

Safety Precautions

To prevent injury to the user or other people and property damage, the following instructions must be followed. Incorrect operation due to ignoring of instructions may cause harm or damage. The seriousness is classified by the following indications.



This symbol indicates the possibility of death or serious injury.



This symbol indicates the possibility of injury or damage to property.

WARNING

Please read through these instructions before you start the installation process. Improper installation can cause damage to the unit, your personal property, and also poses a personal safety hazard.

- Installation must be performed according to the installation instructions. Improper installation can cause water leakage, electrical shock, or fire.
- Use only the included accessories and parts, and specified tools for the installation. Using non-standard parts can cause water leakage, electrical shock, fire, and injury or property damage.
- Make sure that the outlet you are using is grounded and has the appropriate voltage. The power cord is equipped with a three-prong grounding plug to protect against shock. Voltage information can be found on the side of the unit, behind the grille.
- Install the unit in on a flat, sturdy surface. Failure to do so could result in damage or excessive noise and vibration.
- The unit must be kept free from obstruction to ensure proper function and to mitigate safety hazards.
- DO NOT modify the length of the power cord or use an extension cord to power the unit. DO NOT share a single outlet with other electrical appliances. Improper power supply can cause fire or electrical shock.
- DO NOT install your air conditioner in a wet room such as a bathroom or laundry room. Too much exposure to water can cause electrical components to short circuit.
- DO NOT install the unit in a location that may be exposed to combustible gas, as this could cause fire.
- The unit has wheels to facilitate moving. Make sure not to use the wheels on thick carpet or to roll over objects, as these could cause tipping.
- DO NOT operate a unit that has been dropped or damaged.
- Only use the included accessories and specified parts for installation. Using nonstandard parts can cause water leakage, electrical shock, fire, and injury or property damage.

**WARNING**

- The unit must be kept free from obstruction to ensure proper function.
- DO NOT allow children to play with the air conditioner. Children must be supervised around the unit at all times.
- If the air conditioner is knocked over during use, turn off the unit and unplug it from the main power supply immediately. Visually inspect the unit to ensure there is no damage. If you suspect the unit has been damaged, contact a technician or customer service for assistance.
- In a thunderstorm, the power must be cut off to avoid damage to the machine due to lightning.

**CAUTION**

- This appliance can be used by children aged from 8 years and above and person with reduced physical, sensory or mental capabilities or lack of experience and knowledge if they have been given supervision or instruction concerning use of the appliance in a safe way and understand the hazards involved. Children shall not play the appliance. Cleaning and user maintenance shall not be made by children without supervision. (be applicable for the European Countries)
- This appliance is not intended for use by persons (including children) with reduced physical, sensory or mental capabilities or lack of experience and knowledge, unless they have been given supervision or instruction concerning use of the appliance by a person responsible for their safety. (be applicable for other countries except the European Countries)
- Children should be supervised to ensure that they do not play with the appliance.
- If the supply cord is damaged, it must be replaced by the manufacturer, its service agent or similarly qualified persons in order to avoid a hazard.
- Prior to cleaning or other maintenance, the appliance must be disconnected from the supply mains.
- Do not install the appliance in a location that may be exposed to combustible gas.
- If combustible gas accumulates around the unit, it may cause fire.
- Do not run cord under carpeting. Do not cover cord with throw rugs, runners, or similar coverings. Do not route cord under furniture or appliances. Arrange cord away from traffic area and where it will not be tripped over.
- Do not operate unit with a damaged cord or plug. Discard unit or return to an authorized service facility for examination and/or repair.
- To reduce the risk of fire or electric shock, do not use this fan with any solid-state speed control device.
- The appliance shall be installed in accordance with national wiring regulations.
- Contact the authorised service technician for repair or maintenance of this unit.
- Contact the authorised installer for installation of this unit.
- When there are wide differences between “USER’S MANUAL” and “Remote Controller Illustration” on function description, the description on “USER’S MANUAL” shall prevail.
- Do not operate your air conditioner in a wet room such as a bathroom or laundry room.

1

Unit Specifications and Features

Preparation

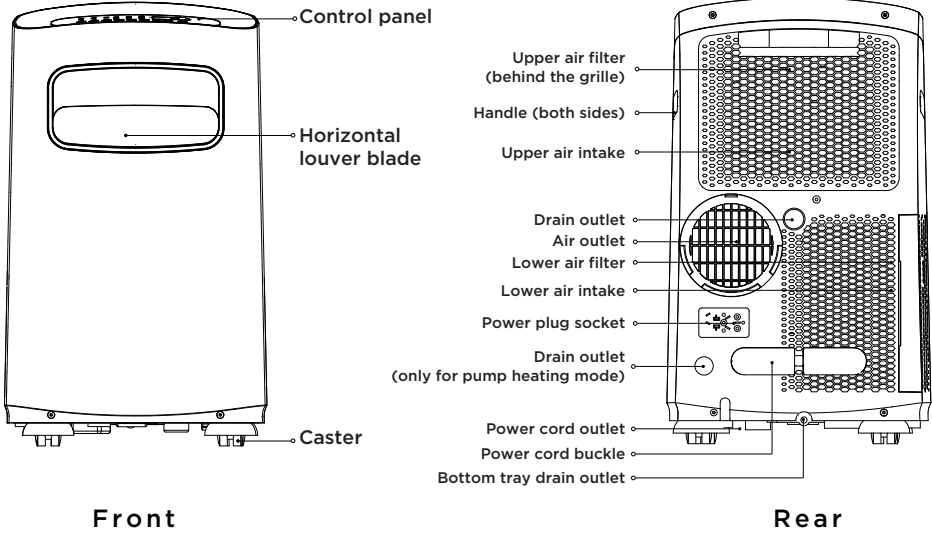

Design and Compliance Notes

Design Notice:

In order to ensure the optimal performance of our products, the design specifications of the unit and remote control are subject to change without prior notice.

Energy Rating Information:

The Energy Rating for this unit is based on an installation using an un-extended exhaust duct without adapters A or B (as shown in the Installation section of this manual).

Unit Temperature Range:

Mode	Temperature Range
Cool	17°C - 35°C (62°F - 95°F)
Dry	13°C - 35°C (55°F - 95°F)
Heat (pump heat mode)	5°C - 30°C (41°F - 86°F)
Heat (electrical heat mode)	≤ 30°C (86°F)

Specifications

MODEL		MPF08CR71	MPF10CR71	MPF12CR71	MPF14CR71	
Power supply		Ph-V-Hz	1Ph, 115V-, 60Hz	1Ph, 115V-, 60Hz	1Ph, 115V-, 60Hz	1Ph, 115V-, 60Hz
Cooling	Capacity	Btu/h	8000	10000	12000	14000
	Rated input	W	900	1130	1350	1575
	Rated current	A	8	10	12	11.8
	EER	W/W	2.6	2.6	2.6	2.6
Btu/W.h		8.9	8.9	8.9	8.9	
Moisture removal (26.7/20.9°C)		L/h	1.2	1.5	1.8	2.1
Moisture removal (35/28.3°C)		L/h	1.6	2.1	2.5	2.9
Starting current		A	30.3	43	48.8	48.8
Indoor side air flow (Hi)	m ³ /h	300	300	350	380	
	CFM	176	176	206	224	
Indoor side noise level (Hi)		dB(A)	55	55	56	56
Refrigerant type		ozs	R410A/9.17	R410A/10.58	R410A/13.76	R410A/20.46
Plug type (NEMA#)			5-15P	5-15P	5-15P	5-15P
Control type			Remote Control	Remote Control	Remote Control	Remote Control
Operating temperature (room temp.)	°C	17 - 35/---	17 - 35/---	17 - 35/---	17 - 35/---	
	°F	62 - 95/---	62 - 95/---	62 - 95/---	62 - 95/---	
Application area (Cooling Standard)	m ²	11-16	13-20	16-23	19-27	
	sq.ft	118-172	140-215	172-248	205-291	
Application area (Cooling EPA)		ft ²	300-350	400-450	500-550	550-700
Dimension (W*D*H)	mm	435*330*730	435*330*730	435*330*730	458*365*774	
	in	17.1*13*28.3	17.1*13*28.3	17.1*13*28.3	18*14.4*30.5	
Net/Gross weight	kg	26/30.5	26/30.5	28.5/33	31/35.1	
	lb	57.2/67.1	57.2/67.1	62.7/72.6	68.3/77.4	

Operating Instructions

2

Key Pad Features

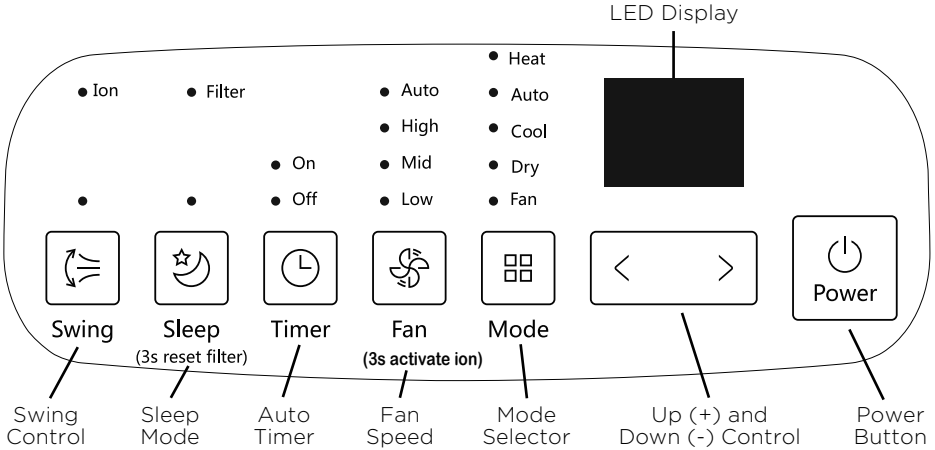

Swing Button (optional)

(Applicable to the models with auto swing feature only)

Used to initiate the Auto swing feature.

When the operation is ON, press the SWING button can stop the louver at the desired angle.

Sleep (Eco)/Filter button

Used to initiate the SLEEP/ECO operation.

NOTE

After 250 hours of operation, the filter indicator light illuminates. This feature is a reminder to clean the Air Filter for more efficient operation. Press this button for 3 seconds to cancel the reminder.

Timer button

Used to initiate the AUTO ON start time and AUTO OFF stop time program, in conjunction with the + & - buttons. The timer on/off indicator light illuminates under the timer on/off settings.

Fan/Ion button (Ion is optional)

Control the fan speed. Press to select the fan speed in four steps - LOW, MID, HIGH and AUTO. The fan speed indicator light illuminates under different fan settings.

NOTE

Press this button for 3 seconds to initiate ION feature. The ion generator is energized and will help to remove pollen and impurities from the air, and trap them in the filter. Press it for 3 seconds again to stop the ION feature.

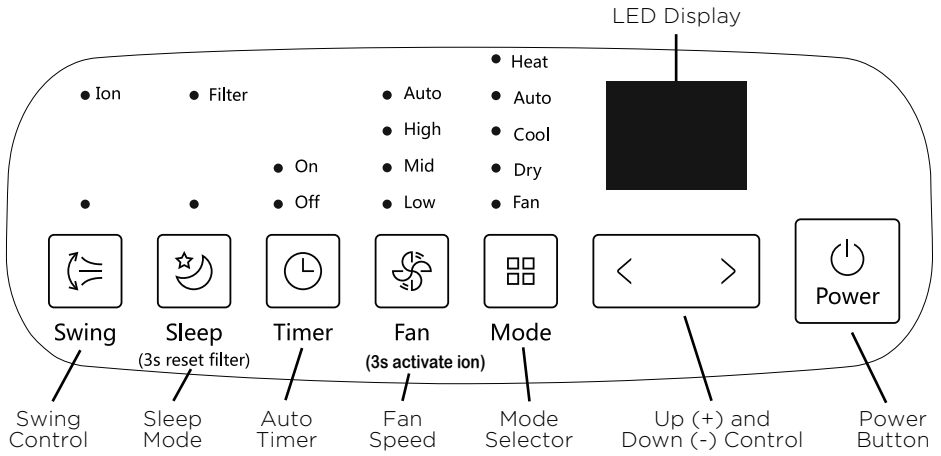

Mode button

Selects the appropriate operating mode. Each time you press the button, a mode is selected in a sequence that goes from AUTO, COOL, DRY, FAN and HEAT (cooling only models without). The mode indicator light illuminates under the different mode settings.

LED display

Shows the set temperature in °C or °F and the Auto-timer settings. While on DRY and FAN modes, it shows the room temperature.

Up (+) and Down (-) buttons

Used to adjust (increasing/decreasing) temperature settings in 1°C/1°F increments in a range of 17°C/62°F to 30°C/86°F or the TIMER setting in a range of 0 - 24hrs.

Shows Error codes and protection code:

- E1** - Room temperature sensor error.
- E2** - Evaporator temperature sensor error.
- E3** - Condenser temperature sensor error (on some models).
- E4** - Display panel communication error.
- E7** - Zero-crossing malfunction.
- P1** - Bottom tray is full -- Connect the drain hose and drain the collected water away. If protection repeats, call for service.

NOTE

The control is capable of displaying temperature in degrees Fahrenheit or degrees Celsius. To convert from one to the other, press and hold the Up and Down buttons at the same time for 3 seconds.

NOTE

When one of the above malfunctions occurs, turn off the unit, and check for any obstructions. Restart the unit, if the malfunction is still present, turn off the unit and unplug the power cord. Contact the manufacturer or its service agents or a similar qualified person for service.

Power button

Power switch on/off.

Operation Instructions

COOL operation

- Press the “MODE” button until the “COOL” indicator light comes on.
- Press the ADJUST buttons “+” or “-” to select your desired room temperature. The temperature can be set within a range of 17°C-30°C/62°F-86°F.
- Press the “FAN SPEED” button to choose the fanspeed.

HEAT operation

(cooling only models without)

- Press the “MODE” button until the “HEAT” indicator light comes on.
- Press the ADJUST buttons “+” or “-” to select your desired room temperature. The temperature can be set within a range of 17°C-30°C/62°F-86°F.
- Press the “FAN SPEED” button to choose the fan speed. For some models, the fan speed can not be adjusted under HEAT mode.

DRY operation

- Press the “MODE” button until the “DRY” indicator light comes on.
- Under this mode, you cannot select a fan speed or adjust the temperature. The fan motor operates at LOW speed.
- Keep windows and doors closed for the best dehumidifying effect.
- Do not put the duct to window.

AUTO operation

- When you set the air conditioner in AUTO mode, it will automatically select cooling, heating (cooling only models without), or fan only operation depending on what temperature you have selected and the room temperature.
- The air conditioner will control room temperature automatically round the temperature point set by you.
- Under AUTO mode, you can not select the fan speed.

FAN operation

- Press the “MODE” button until the “FAN” indicator light comes on.

- Press the “FAN SPEED” button to choose the fan speed. The temperature can not be adjusted.
- Do not put the duct to window.

TIMER operation

- When the unit is on, press the Timer button will initiate the Auto-off stop program, the TIMER OFF indicator light illuminates. Press the UP or down button to select the desired time. Press the TIMER button again within 5 seconds, the Auto-on start program is initiated. And the TIMER ON indicator light illuminates. Press the up or down button to select the desired Auto-on start time.
- When the unit is off, press the Timer button to initiate the Auto-on start program, press it again within five seconds will initiate the Auto-off stop program.
- Press or hold the UP or DOWN button to change the Auto time by 0.5 hour increments, up to 10 hours, then at 1 hour increments up to 24 hours. The control will count down the time remaining until start.
- The system will automatically revert back to display the previous temperature setting if there is no operation in a 5 seconds period.
- Turning the unit ON or OFF at any time or adjusting the timer setting to 0.0 will cancel the Auto Start/Stop timer program.
- When the malfunction occurs, the Auto Start/Stop timed program will also be cancelled.

SLEEP/ECO operation

Press this button, the selected temperature will increase (cooling) or decrease (heating) by 1°C/1°F 30 minutes. The temperature will then increase (cooling) or decrease (heating) by another 1°C/1°F after an additional 30 minutes. This new temperature will be maintained for 7 hours before it returns to the originally selected temperature. This ends the Sleep/Eco mode and the unit will continue to operate as originally programmed.

NOTE

This feature is unavailable under FAN or DRY mode.

Other Features

FOLLOW ME/TEMP SENSING

Feature (optional)

NOTE

This feature can be activated from the remote control **ONLY**. The remote control serves as a remote thermostat allowing for the precise temperature control at its location.

To activate the Follow Me/Temp Sensing feature, point the remote control towards the unit and press the Follow Me/Temp Sensing button. The remote display is actual temperature at its location. The remote control will send this signal to the air conditioner every 3 minutes interval until press the Follow Me/Temp Sensing button again. If the unit does not receive the Follow Me/Temp Sensing signal during any 7 minutes interval, the unit will beep to indicate the Follow Me/Temp Sensing mode has ended.

AUTO-RESTART

If the unit breaks off unexpectedly due to the power cut, it will restart with the previous function setting automatically when the power resumes.

WAIT 3 MINUTES BEFORE RESUMING OPERATION

After the unit has stopped, it can not be restarted operation in the first 3 minutes. This is to protect the unit. Operation will automatically start after 3 minutes.

AIR FLOW DIRECTION ADJUSTMENT

The louver can be adjusted automatically. Adjust the air flow direction automatically.

NOTE

On some models the louver can be adjusted manually only):

- When the Power is ON, the louver opens fully.
- Press the SWING button on the panel or remote controller to initiate the Auto swing feature. The louver will swing up and down automatically.
- Please do not adjust the louver manually.

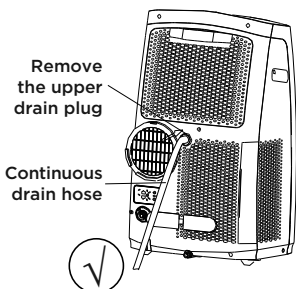

Water drainage

- During dehumidifying modes, remove the upper drain plug from the back of the unit, install the drain connector (5/8" universal female mender) with 3/4" hose (locally purchased). For the models without drain connector, just attach the drain hose to the hole. Place the open end of the hose directly over the drain area in your basement floor.

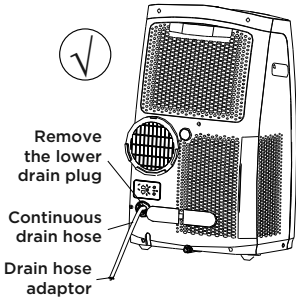

- During heating pump mode, remove the lower drain plug from the back of the unit, install the drain connector (5/8" universal female mender) with 3/4" hose (locally purchased). For the models without drain connector, just attach the drain hose to the hole. Place the open end of the Hose adaptor directly over the drain area in your basement floor.

NOTE

Make sure the hose is secure so there are no leaks. Direct the hose toward the drain, making sure that there are no kinks that will stop the water flowing. Place the end of the hose into the drain and make sure the end of the hose is down to let the water flow smoothly. (See Figs with \checkmark). Do never let it up. (See Figs with \times). When the continuous drain hose is not used, ensure that the corresponding drain plug and knob are installed firmly to prevent leakage.

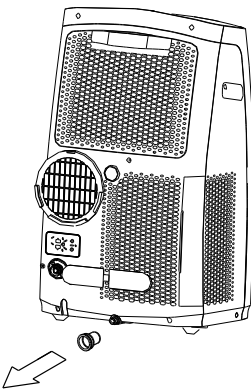
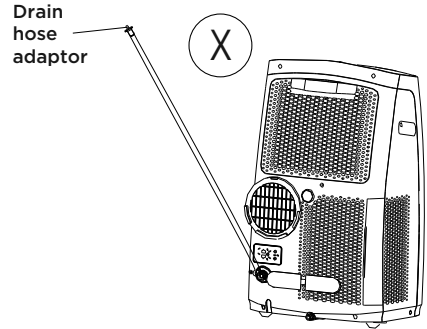
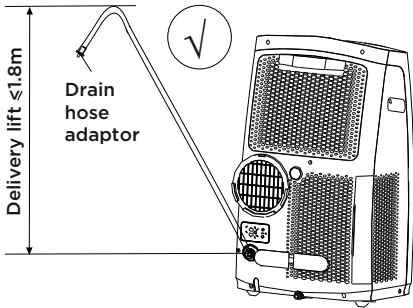

- When the water level of the bottom tray reaches a predetermined level, the unit beeps 8 times, the digital display area shows "P1". At this time the air conditioning/dehumidification process will immediately stop. However, the fan motor will continue to operate (this is normal). Carefully move the unit to a drain location, remove the bottom drain plug and let the water drain away. Reinstall the bottom drain plug and restart the machine until the "P1" symbol disappears. If the error repeats, call for service.

NOTE

Be sure to reinstall the bottom drain plug firmly to prevent leakage before using the unit.

Installation Instructions

3

Choosing the Right Location

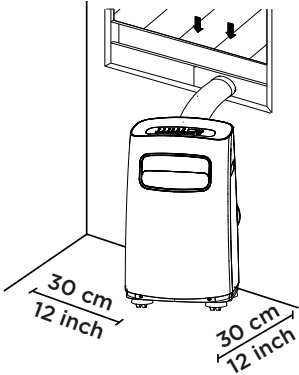

Your installation location should meet the following requirements:

- Make sure that you install your unit on an even surface to minimize noise and vibration.
- The unit must be installed near a grounded plug, and the Collection Tray Drain (found on the back of the unit) must be accessible.
- The unit should be located at least 30 cm (12") from the nearest wall to ensure proper air conditioning.
- DO NOT cover the Intakes, Outlets or Remote Signal Receptor of the unit, as this could cause damage to the unit.

Note About Fluorinated Gasses

- This air-conditioning unit is a hermetically sealed unit that contains fluorinated gasses. For specific information on the type of gas and the amount, please refer to the relevant label on the unit itself.
- Installation, service, maintenance and repair of this unit must be performed by a certified technician.
- Product uninstallation and recycling must be performed by a certified technician.
- If the system has a leak-detection system installed, it must be checked for leaks at least every 12 months.
- When the unit is checked for leaks, proper record-keeping of all checks is strongly recommended.

NOTE

All the illustrations in the manual are for explanation purpose only. Your machine may be slightly different.

The actual shape shall prevail.











The unit can be controlled by the unit control panel alone or with the remote controller. This manual does not include Remote Controller Operations, see the <<Remote Controller Instruction>> packed with the unit for details.

Tool Needed

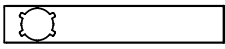
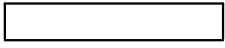
- Medium Philips screwdriver;
- Tape measure or ruler;
- Knife or scissors;
- Saw (optional, to shorten window adaptor for narrow windows).

Accessories

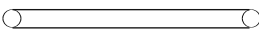
Your Window Installation Kit fits windows 67.5-123 cm (26.5-48") and can be shortened for smaller windows.

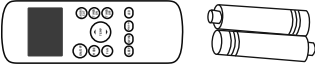
Part	Description	Quantity
	Unit adaptor	1 pc
	Exhaust hose	1 pc
	Window slider adaptor	1 pc
	Bolt	1 pc
	Window slider A	1 pc
	Window slider B	1 pc
	Foam seal A (adhesive)	2 pc
	Foam seal B (adhesive)	2 pc
	Foam seal C (Non-adhesive)	1 pc
	Security bracket and 2 screws	1 set
	Drain hose	1 pc
	Drain hose adaptor (only for heat pump mode)	1 pc
	Remote controller and battery (For remote control models only)	1 set

Window Installation Kit

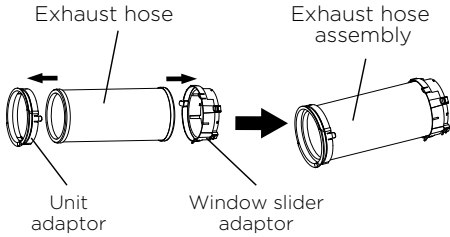

Step One: Preparing the exhaust hose assembly

Press the exhaust hose into the window slider adaptor and unit adaptor, clamp automatically by elastic buckles of the adaptors.

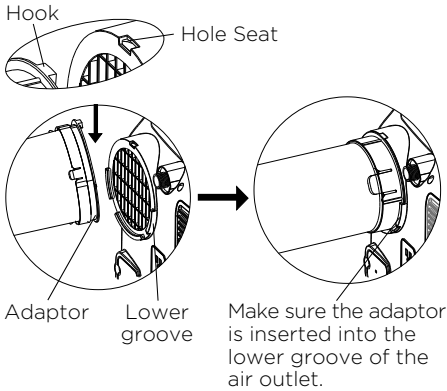

Step Two: Install the exhaust hose assembly to the unit

Insert unit adaptor of the Exhaust hose assembly into the lower groove of the air outlet of the unit while the hook of the adaptor is aligned with the hole seat of the air outlet and slide down the Exhaust hose assembly along the arrow direction for installation.

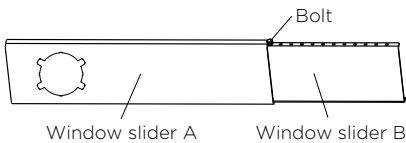

Step Three: Preparing the adjustable window slider

1. Depending on the size of your window, adjust the size of the window slider.
2. If the length of the window requires two window sliders, use the bolt to fasten the window sliders once they are adjusted to the proper length.

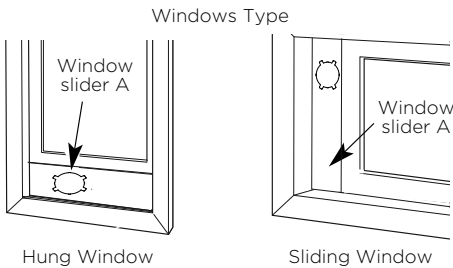

NOTE

Once the Exhaust Hose assembly and Adjustable Window Slider are prepared, choose from one of the following two installation methods.

Foam seal B
(Adhesive type-shorter)

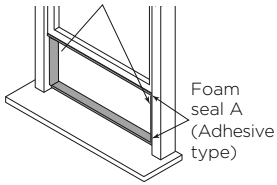

Type 1: Hung window installation

1. Cut the adhesive foam seal A and B strips to the proper lengths, and attach them to the window sash and frame as shown.

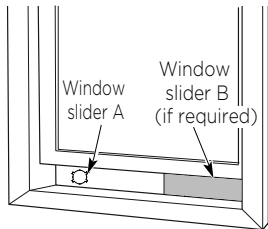

2. Insert the window slider assembly into the window opening.

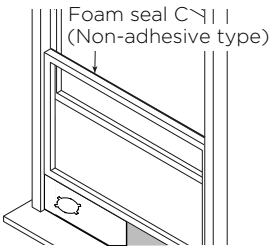

3. Cut the non-adhesive foam seal C strip to match the width of the window. Insert the seal between the glass and the window frame to prevent air and insects from getting into the room.

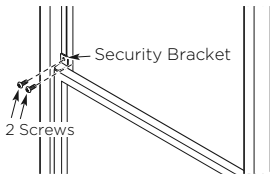

4. If desired, install the security bracket with 2 screws as shown.

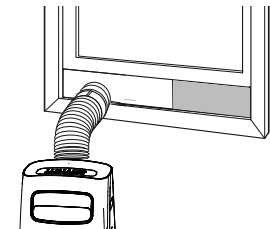

5. Insert the window slider adaptor into the hole of the window slider.

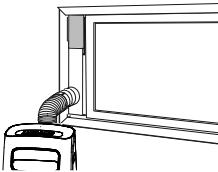
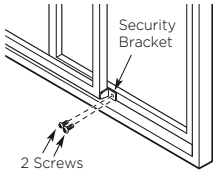
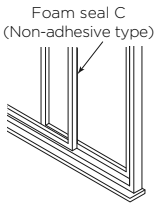
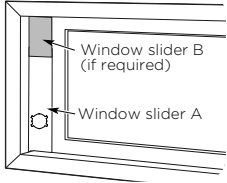
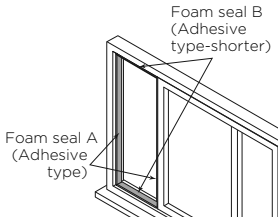

Type 2: Sliding window installation

1. Cut the adhesive foam seal A and B strips to the proper lengths, and attach them to the window sash and frame as shown.
2. Insert the window slider assembly into the window opening.
3. Cut the non-adhesive foam seal C strip to match the window height. Insert the foam seal between the glass and the window frame to prevent air and insects from getting into the room.
4. If desired, install the security bracket with 2 screws as shown.
5. Insert the window slider adaptor into the hole of the window slider.

NOTE

To ensure proper function, **DO NOT** overextend or bend the hose. Make sure that there is no obstacle around the air outlet of the exhaust hose (in the range of 500mm) in order to the exhaust system works properly. All the illustrations in this manual are for explanation purpose only. Your air conditioner may be slightly different. The actual shape shall prevail.



Care and Cleaning

4

Safety Precautions

- Always unplug the unit before cleaning or servicing.
- DO NOT use flammable liquids or chemicals to clean the unit.
- DO NOT wash the unit under running water. Doing so causes electrical danger.
- DO NOT operate the machine if the power supply was damaged during cleaning. A damaged power cord must be replaced with a new cord from the manufacturer.

Clean the Air Filter

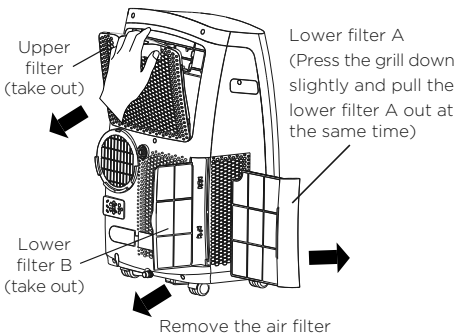

Maintenance Tips

- Be sure to clean the air filter every 2 weeks for optimal performance.
- The water collection tray should be drained immediately after P1 error occurs, and before storage to prevent mold.
- In households with animals, you will have to periodically wipe down the grill to prevent blocked airflow due to animal hair.

Clean the Unit

Clean the unit using a damp, lint-free cloth and mild detergent. Dry the unit with a dry, lint-free cloth.

Store the Unit When Not in Use

- Drain the unit's water collection tray according to the instructions in the following section.
- Run the appliance on FAN mode for 12 hours in a warm room to dry it and prevent mold.
- Turn off the appliance and unplug it.
- Clean the air filter according to the instructions in the previous section. Reinstall the clean, dry filter before storing.
- Remove the batteries from the remote control.

NOTE

Be sure to store the unit in a cool, dark place. Exposure to direct sunshine or extreme heat can shorten the lifespan of the unit.

Troubleshooting Tips

5

Faults Diagnosis

Please check the machine according to the following form before asking for maintenance:

Problem	Possible Cause	Troubleshooting
Unit does not turn on when pressing ON/OFF button	P1 Error Code.	The water collection tray is full. Turn off the unit, drain the water from the water collection tray and restart the unit.
	In COOL mode: room temperature is lower than the set temperature.	Reset the temperature.
Unit does not cool well	The air filter is blocked with dust or animal hair.	Turn off the unit and clean the filter according to instructions.
	Exhaust hose is not connected or is blocked.	Turn off the unit, disconnect the hose, check for blockage and reconnect the hose.
	The unit is low on refrigerant.	Call a service technician to inspect the unit and top off refrigerant.
	Temperature setting is too high.	Decrease the set temperature.
	The windows and doors in the room are open.	Make sure all windows and doors are closed.
	The room area is too large.	Double-check the cooling area.
	There are heat sources inside the room.	Remove the heat sources if possible.
The unit is noisy and vibrates too much	The ground is not level.	Place the unit on a flat, level surface.
	The air filter is blocked with dust or animal hair.	Turn off the unit and clean the filter according to instructions.
The unit makes a gurgling sound	This sound is caused by the flow of refrigerant inside the unit	This is normal.

Remote Control Operating Instructions

6

Remote Control Specifications

Model	RG57H2(B)/BG(C)EF
Rated voltage	3.0V (Dry batteries RO3/LR03x2)
Signal receiving range	8 m
Environment	-5°C - 60°C (23°F - 140°F)

Function Buttons

Before you begin using your new air conditioner, make sure to familiarize yourself with its remote control. The following is a brief introduction to the remote control itself. For instructions on how to operate your air conditioner, refer to the How to Use Basic Functions section of this manual.

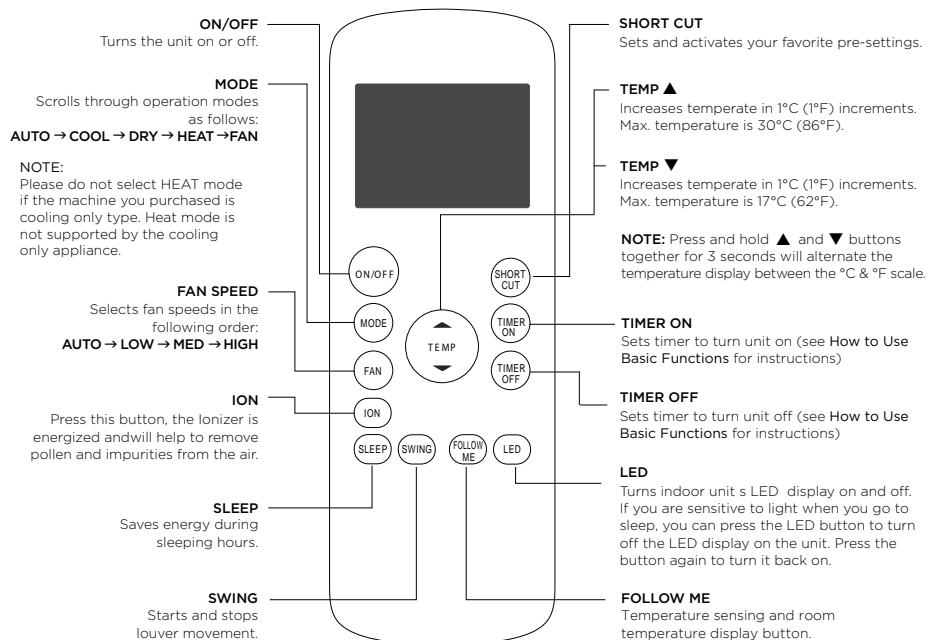

Operating Instructions (With Remote)

NOTE

Swing, Ion and Follow me features are optional. RG57H1(B)/BG(C)E-M without med fan speed.

Handing the Remote Control

NOT SURE WHAT A FUNCTION DOES?

Refer to the How to Use Basic Functions and How to Use Advanced Functions sections of this manual for a detailed description of how to use your air conditioner.

SPECIAL NOTE

Button designs on your unit may differ slightly from the example shown.

If the unit does not have a particular function, pressing that function's button on the remote control will have no effect.

When there are wide differences between Remote control Illustration and "USER'S MANUAL" on function description, the description of "USER'S MANUAL" shall prevail.

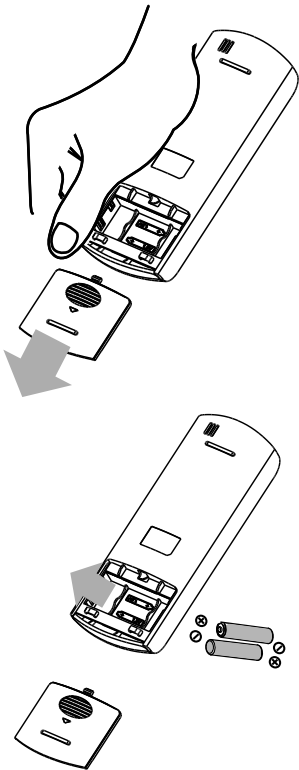

INSERTING AND REPLACING BATTERIES

Your air conditioning unit comes with two AAA batteries. Put the batteries in the remote control before use.

1. Slide the back cover from the remote control downward, exposing the battery compartment.
2. Insert the batteries, paying attention to match up the (+) and (-) ends of the batteries with the symbols inside the battery compartment.
3. Slide the battery cover back into place.

BATTERY NOTES

For optimum product performance:

- Do not mix old and new batteries, or batteries of different types.
- Do not leave batteries in the remote control if you don't plan on using the device for more than 2 months.

BATTERY DISPOSAL

Do not dispose of batteries as unsorted municipal waste. Refer to local laws for proper disposal of batteries.

TIPS FOR USING REMOTE CONTROL

- The remote control must be used within 8 meters / 26 feet of the unit.
- The unit will beep when remote signal is received.
- Curtains, other materials and direct sunlight can interfere with the infrared signal receiver.
- Remove batteries if the remote will not be used more than 2 months.

How to Use Use the Basic Fuctions

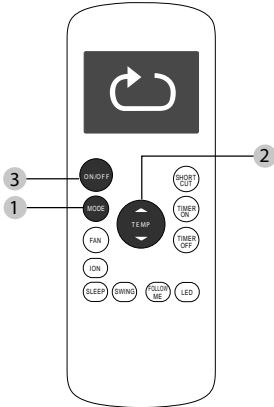

SETTING TEMPERATURE

The operating temperature range for units is 17-30°C (62°F-86°F). You can increase or decrease the set temperature in 1°C (1°F) increments.

AUTO operation

In AUTO mode, the unit will automatically select the COOL, FAN, HEAT or DRY mode based on the set temperature.

1. Press the MODE button to select Auto mode.
2. Set your desired temperature using the Temp ▲ or Temp ▼ button.
3. Press the ON/OFF button to start the unit.

NOTE

FAN SPEED can't be set in AUTO mode.

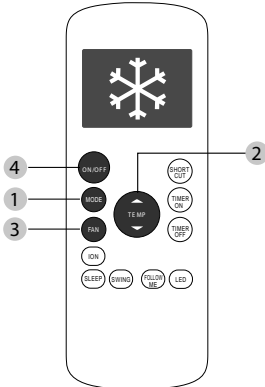

COOL operation

1. Press the MODE button to select COOL mode.
2. Set your desired temperature using the Temp ▲ or Temp ▼ button.
3. Press the FAN button to select the fan speed: AUTO, LOW, MED, or HIGH.
4. Press the ON/OFF button to start the unit.

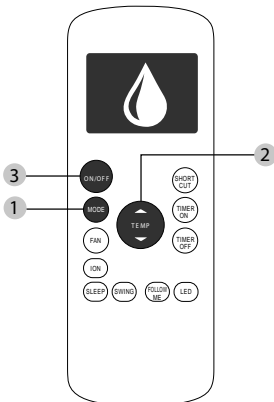

DRY operation(dehumidifying)

1. Press the MODE button to select DRY mode.
2. Set your desired temperature using the Temp ▲ or Temp ▼ button.
3. Press the ON/OFF button to start the unit.

NOTE

FAN SPEED can't be set in DRY mode.

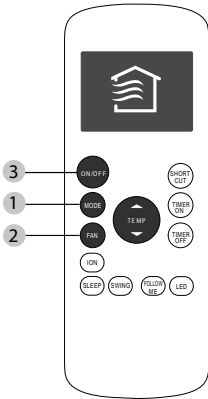

FAN operation

1. Press the MODE button to select FAN mode.
2. Press FAN button to select the fan speed: AUTO, LOW, MED or HIGH.
3. Press the ON/OFF button to start the unit.

NOTE

You can't set temperature in FAN mode. As a result, your remote control's LCD screen will not display temperature.

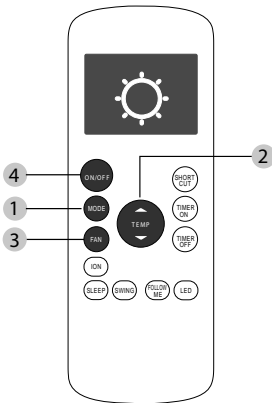

HEAT operation

1. Press the MODE button to select HEAT mode.
2. Set your desired temperature using the Temp ▲ or Temp ▼ button.
3. Press the FAN button to select the fan speed: AUTO, LOW, MED, or HIGH.
4. Press the ON/OFF button to start the unit.

NOTE

As outdoor temperature drops, the performance of your unit's HEAT function may be affected. In such instances, we recommend using this air conditioner in conjunction with other heating appliance.

Setting the Timer Functions

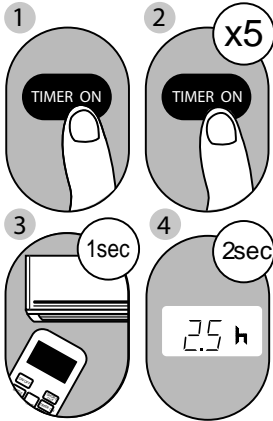

Example: Setting unit to turn on after 2.5 hours.

Your air conditioning unit has two timer-related functions:

TIMER ON - sets the amount of timer after which the unit will automatically turn on.

TIMER OFF - sets the amount of time after which the unit will automatically turn off.

TIMER ON function

The TIMER ON function allows you to set a period of time after which the unit will automatically turn on, such as when you come home from work.

1. Press the TIMER ON button. By default, the last time period that you set and an "h" (indicating hours) will appear on the display.

NOTE

This number indicates the amount of time after the current time that you want the unit to turn on.

For example, if you set TIMER ON for 2 hours, "2.0h" will appear on the screen, and the unit will turn on after 2 hours.

2. Press the TIMER ON button repeatedly to set the time when you want the unit to turn on.
3. Wait 2 seconds, then the TIMER ON function will be activated. The digital display on your remote control will then return to the temperature display.

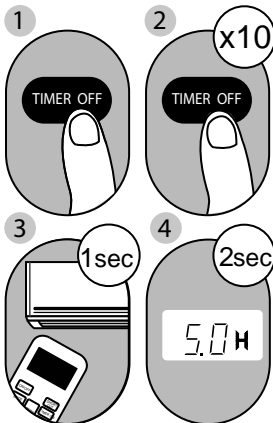

Example: Setting unit to turn off after 5 hours.

TIMER OFF function

The TIMER OFF function allows you to set a period of time after which the unit will automatically turn off, such as when you wake up.

1. Press the TIMER OFF button. By default, the last time period that you set and an "h" (indicating hours) will appear on the display.

NOTE

This number indicates the amount of time after the current time that you want the unit to turn off.

For example, if you set TIMER OFF for 2 hours, "2.0h" will appear on the screen, and the unit will turn off after 2 hours.

2. Press the TIMER OFF button repeatedly to set the time when you want the unit to turn off.

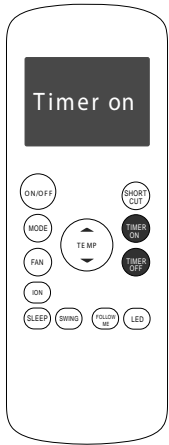

Continue to press **TIMER ON** or **TIMER OFF** until desired time is reached.

3. Wait 2 seconds, then the **TIMER OFF** function will be activated. The digital display on your remote control will then return to the temperature display.

NOTE

When setting the **TIMER ON** or **TIMER OFF** functions, up to 10 hours, the time will increase in 30 minute increments with each press. After 10 hours and up to 24, it will increase in 1 hour increments. The timer will revert to zero after 24 hours.

You can turn off either function by setting its timer to "0.0h".

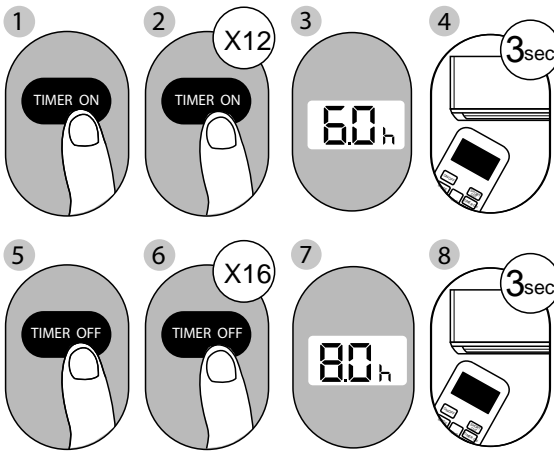

Setting both **TIMER ON** and **TIMER OFF** at the same time

Keep in mind that the time periods you set for both functions refer to hours after the current time. For example, say that the current time is 1:00 PM, and you want the unit to turn on automatically at 7:00 PM. You want it to operate for 2 hours, then automatically turn off at 9:00 PM.

Do the following (side figure):

Example: Setting the unit to turn on after 6 hours, operate for 2 hours, then turn off (see the figure below)

Your remote display

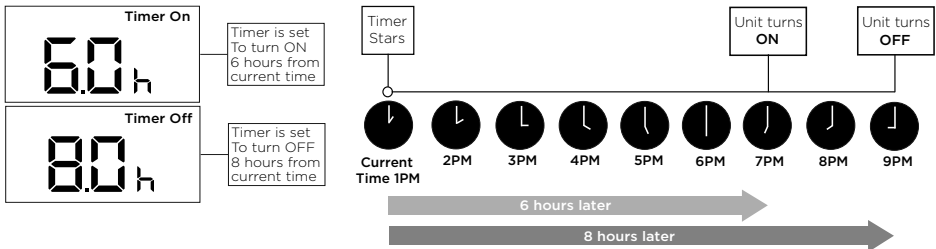

How to Use Use the Advanced Fuctions

SLEEP Function

The SLEEP function is used to decrease energy use while you sleep (and don t need the same temperature settings to stay comfortable). This function can only be activated via remote control.

Note: The SLEEP function is not available in FAN or DRY mode.

SWING Function

Used to stop or start louver movement and set the desired up/down air flow direction. The louver changes 6 degrees in angle for each press (some models without). If keep pushing more than 2 seconds, the louver auto swing feature is activated.

FOLLOW ME Function

The FOLLOW ME function enables the remote control to measure the temperature at its current location. When using AUTO, COOL, or HEAT functions, measuring ambient temperature from the remote control (instead of from the indoor unit it self) will enable the air conditioner to optimize the temperature around you and ensure maximum comfort.

1. Press FOLLOW ME button to activate function. The remote control will send temperature signal to the unit every three minutes.
2. Press FOLLOW ME button again to turn off this function.

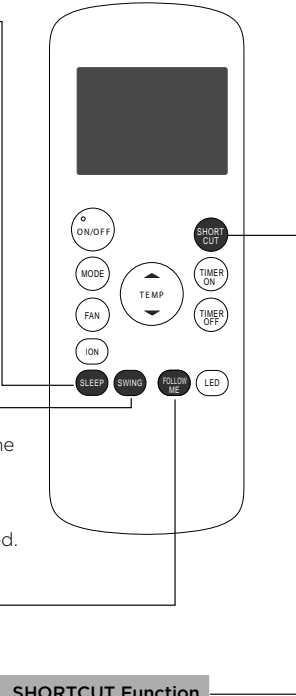

SHORTCUT Function

- Used to restore the current settings or resume previous settings.
- Push this button when remote controller is on, the system will automatically revert back to the previous settings including operating mode, setting temperature, fan speed level and sleep feature (if activated).
- If pushing more than 2 seconds, the system will automatically restore the current operation settings including operating mode, setting temperature, fan speed level and sleep feature (if activated).

NOTES

- Buttons design is based on typical model and might be slightly different from the actual one you purchased, the actual shape shall prevail.
- All the functions described are accomplished by the unit, if the unit has no this feature, there is no corresponding operation happened when press the relative button on the remote controller.

NOTES

- When there are wide differences between remote controller Illustration and “USER’S MANUAL” on function description, the description on “USER’S MANUAL” shall prevail.
- The device could comply with the local national regulations. In Canada, it should comply with CAN ICES-3(B)/NMB-3(B). In USA, this device complies with part 15 of the FCC Rules. Operation is subject to the following two conditions: (1) This device may not cause harmful interference, and (2) this device must accept any interference received, including interference that may cause undesired operation.
- This equipment has been tested and found to comply with the limits for a Class B digital device, pursuant to part 15 of the FCC Rules. These limits are designed to provide reasonable protection against harmful interference in a residential installation. This equipment generates, uses and can radiate radio frequency energy and, if not installed and used in accordance with the instructions, may cause harmful interference to radio communications. However, there is no guarantee that interference will not occur in a particular installation. If this equipment does cause harmful interference to radio or television reception, which can be determined by turning the equipment off and on, the user is encouraged to try to correct the interference by one or more of the following measures:
 - Reorient or relocate the receiving antenna.
 - Increase the separation between the equipment and receiver.
 - Connect the equipment into an outlet on a circuit different from that to which the receiver is connected.
 - Consult the dealer or an experienced radio/TV technician for help. Changes or modifications not approved by the party responsible for compliance could void users authority to operate the equipment.

Sociable Remark

7

When using this dehumidifier in the European countries, the following information must be followed:

DISPOSAL

Do not dispose this product as unsorted municipal waste. Collection of such waste separately for special treatment is necessary.

It is prohibited to dispose of this appliance in domestic household waste.

For disposal, there are several possibilities:

- A. The municipality has established collection systems, where electronic waste can be disposed of at least free of charge to the user.
 - B. When buying a new product, the retailer will take back the old product at least free of charge.
 - C. The manufacture will take back the old appliance for disposal at least free of charge to the user.
 - D. As old products contain valuable resources, they can be sold to scrap metal dealers.
- Wild disposal of waste in forests and landscapes endangers your health when hazardous substances leak into the ground-water and find their way into the food chain.

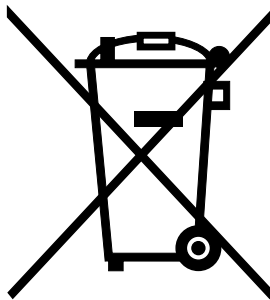



make yourself at home