



Owner's Manual

bObi by bObsweep

Owner's Manual

How to employ your intelligent floor cleaner

Congratulations on purchasing your intelligent floor cleaner! bObi is now at your service. To see bObi at her best, please read the Quick Start Guide and this manual thoroughly.

If you ever have questions or concerns feel free to contact our helpful team at support@bobsweep.com. Welcome to the bObsweep family and happy cleaning!

Contents at a Glance

Important Safety Instructions

Components

Installing the Battery

Turning bObi ON/OFF

Working Modes

Charging Station

Charging bObi

Mop

Remote Control

Cleaning Schedule

Maintenance

Troubleshooting

Checkup Guide

Warranty and Support

bObi FAQs

Important Safety Instructions

Basic safety precautions should always be observed, including the following:

To protect against electrical shock, do not immerse any part of bObi into water or other liquids. bObi's dustbin may be washed with water only once her motor has been removed.

Turn bObi OFF when she is not in use and before conducting maintenance.

If bObi, her remote control, or her charging station has been damaged, do not operate them. Contact our customer care center.

If bObi is not working as she should or has been dropped, damaged, left outdoors, or immersed in water, contact our customer care center.

Do not handle bObi, her remote control, or her charging station with wet hands; use only on dry surfaces.

bObi is not intended for use by persons (including children) with reduced physical or mental capabilities, or lack of experience and knowledge.

Do not pull or carry the charging station by the cord, use the cord as a handle, close a door on the cord, or pull the cord around sharp edges or corners. Keep the cord away from heated surfaces. Do not unplug the cord by pulling on it. To unplug the cord grasp the plug, not the cord.

Do not mutilate or incinerate the battery, as it will explode at high temperatures.

Do not attempt to open the charging station. Repairs on the charging station should only be carried out by our qualified customer care center.

Do not expose bObi, her remote control, or charging station to temperatures higher than 45° C (113° F) or moisture or humidity. Do not use bObi outdoors.

Do not let bObi pick up toxic materials (chlorine bleach, ammonia, drain cleaner, etc.).

bObi is composed of electronic components that in rare and unintended cases can cause hazards of heating, fire, and other malfunctions. Furthermore, because bObi

is capable of and intended for autonomous movement and cleaning, its use poses the risk of collision with property, pets, and persons, and unintended removal of articles, such as small valuables, jewelry, or hair of persons or pets lying on the floor, among others.

Do not let bObi pick up anything that is burning or smoking, such as cigarettes, matches, or hot ashes.

Do not use bObi to pick up flammable or combustible liquids such as gasoline, nor use her in areas where they may be present.

Do not use bObi in an enclosed space filled with vapors given off by oil based paint, paint thinner, moth proofing substances, flammable dust, or other explosive or toxic vapors.

Leaks from battery cells can occur under extreme usage or temperature conditions. If the liquid gets on skin, wash quickly with water. If the liquid gets into the eyes, flush them immediately with clean water for a minimum of 10 minutes. Seek medical attention immediately.

Do not dispose of your battery in fire. Old batteries should be recycled safely (check with your local recycler).

Do not look directly into the UV light.

Do not use bObi for other than intended usage.

Components

What comes in bObi's box?



bObi



Charging station



Charging adapter

2 main brushes



Remote control

Screwdriver



2 side brushes



Cleaning brush (to clean bObi)

Extra screws & Blindfold stickers



Mop extension



2 mop cloths



Filter refill

Owner's manual, quick start guide



Syncing tool



bObi's anatomy

Top view



Bottom view



Charging station



Remote



Get bObi Ready for Cleaning

Installing the Battery

When bObi first arrives, her battery is not installed. To install bObi's battery, place bObi on a flat surface and set her power switch to OFF.

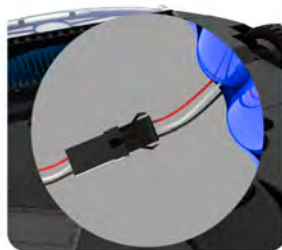
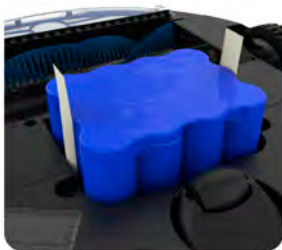

1 Using the provided Phillips screwdriver, remove the screws on the battery cover.

2 Remove the battery cover. Remove bObi's battery from the packaging.

3 Check which way the connectors go on both the battery and its compartment.

Turning bObi ON/OFF

bObi's power switch is located on her side. Use this switch to turn bObi ON or OFF. If bObi is not cleaning and the power switch is left ON, she enters standby mode, which uses a small amount of battery. When in stand-by mode, bObi beeps every few minutes to remind you to charge her or to turn her OFF. Remember to turn the power switch OFF when you are not using bObi to conserve her battery life.



Working Modes

There are three touch buttons on top of bObi:

JUICE, WAFFLE, and GO!

These buttons will not work while bObi is on her charging station. To use these buttons, you must first move bObi from her charging station manually or using her remote control, and then press the buttons on top of bObi while she is on the floor.



GO!

The GO! button activates bObi's default cleaning mode. In this mode she will use her programmed algorithm to clean the floor. To use this mode, simply touch the GO! button found on top of bObi or click the GO! button on her remote.

Clear away clutter and cords before letting bObi clean a room.

WAFFLE

Waffle cleaning mode can be used to clean up small spills of dry substances. In Waffle cleaning mode, bObi will clean an area of approximately 10 square feet (1 square meter) for about 3 minutes before she stops and enters standby mode. Waffle cleaning mode can be used to clean up small spills of dry substances. To have bObi clean a small area, press the WAFFLE button on bObi's cover or on her remote.

JUICE

Pressing the JUICE button makes bObi stop cleaning and start searching for her charging station. When she detects her charging station, she will dock herself and start juicing.

bObi's main brush and vacuuming motor do not work while in Juice mode.

bObi enters Juice mode automatically when her battery level falls below 15%.

Charging Station



Sync button is located on the back of the charging station

Setting up bObi's charging station

Position bObi's charging station against a wall on a hard flat surface. Make sure that there is at least 10 feet (3 meters) of open space in front of the charging station and 2 feet (0.5 meters) on either side of the station. Plug the adapter into the charging station. The nightlight on top of the charging station will turn on.

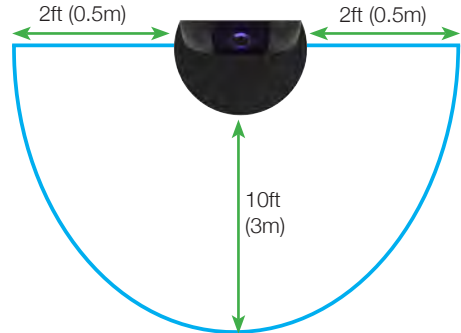

bObi can accidentally run over her adapter cord and get it tangled in her brush. Help bObi avoid this by hiding the cord behind her station and securing it between the charging station and the wall.

Syncing bObi with her charging station

If bObi can't find her charging station, the station and bObi are out of sync and you need to sync up their coding. Follow these steps:

1. Bring bObi close to her charging station.
2. Disconnect the charging station from the adapter.
3. Set the power switch on bObi's side to OFF.
4. Plug the adapter into the charging station.
5. Use the syncing tool to press and hold the sync button on back of the charging station.
6. While holding down the sync button, set bObi's power switch to ON.
7. bObi will emit a series of chirps to indicate the charging station has been synchronized.
8. If you do not hear the chirps, turn bObi and the charging station OFF, disconnect the station from the adapter, and wait a few minutes before repeating the process (restart from step 1).

Charging bObi

bObi is powered by a rechargeable battery. She will perform best if she juices up for 12 hours prior to her first cleaning mission.

Manual charging using the charging station

1. Turn bObi ON and place her directly onto her plugged-in charging station.
2. Make sure bObi's charging electrodes (on her front) make full contact with the station's electrodes.
3. To indicate that she is successfully connected, bObi flashes the middle orange LED light on her cover. The charging station's red nightlight also flashes slowly.
4. When bObi is done juicing (approximately 4-5 hours), the flashing light on her cover becomes solid and the charging station's nightlight flashes faster.

Manual charging using the adapter

While bObi is OFF, plug her charging adapter directly into her side. The power inlet is next to bObi's "ON/OFF" switch. bObi will chirp, flash her cover lights, then chirp again to let you know that she's connected. Her center LED light will blink orange to indicate that she is charging and turn solid orange when she's fully juiced.

Automatic charging

bObi will automatically start searching for her charging station when her battery falls below 15%. She will emit a series of chirps, stop her vacuum motor to preserve energy, and light up the JUICE button on her cover. She will move around, make full circles, and communicate with her station. When bObi detects the charging station, she will move her way towards it, dock, and begin to charge. You will know bObi is fully charged when the middle LED light on her cover stops blinking and turns solid.

If bObi cannot find her charging station, she will continue searching until her battery runs out, at which point you can manually pick her up and connect her to her station (see manual charging).

If bObi's battery drains fully before recharging, she will not be able to recharge on her charging station. Charge her manually by plugging her directly into the adapter.

Remote Control

The remote control is your most useful tool when communicating with bObi. It allows you to schedule bObi to clean your home automatically and to direct her to work in any of her modes. It also allows you to alter and control bObi's movements as she is cleaning. Each time you select an action on the remote, bObi will chirp once before performing the designated function.

bObi's remote control requires two AAA batteries (not included). Do not leave the batteries in the remote if you are not using it on a regular basis. Keep the remote at a normal room temperature.

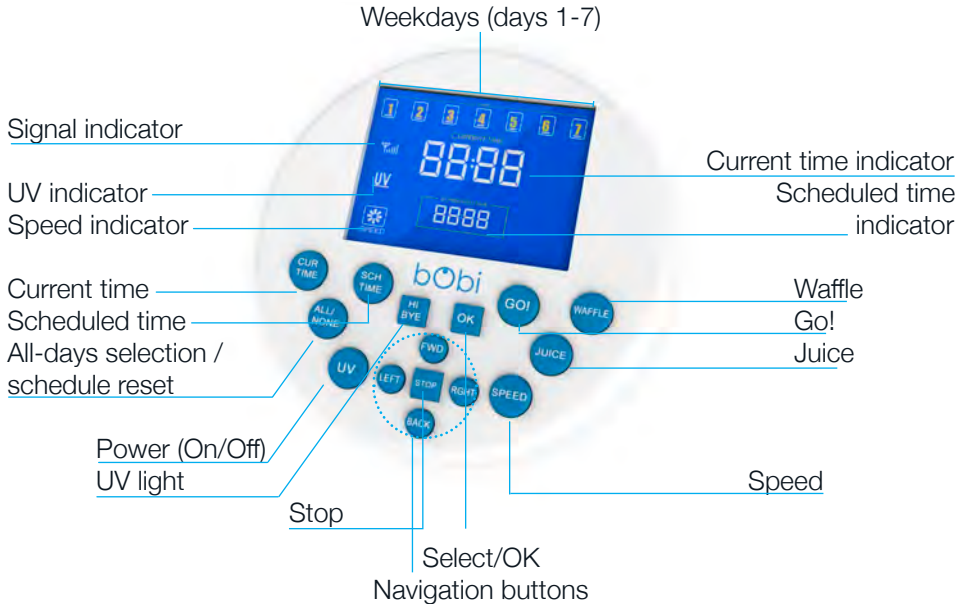

Using the direction buttons to steer bObi with her remote

If you want to turn bObi or drive her backwards, hold down the applicable direction button until she is in the correct direction. When you release the button, bObi will move forward. If you press the back button, bObi will move backwards as long as the button is held and will stop when it is released.

The STOP button in the center of the direction buttons will interrupt bObi's cleaning cycle and stop her until you press another button.

Be careful! Do not drive bObi in reverse towards edges or she could fall. The edge detection system only works when bObi is moving forward.



Choosing bObi's cleaning speed with her remote



bObi's default setting is fast mode, which maximizes the area she covers while cleaning. You can slow bObi down for a deeper, more thorough cleaning.

Press the SPEED button on bObi's remote control to toggle between fast or slow modes. The fan on the lower left side of her remote screen indicates slow mode by displaying only four blades and fast mode by displaying full blades.

Mop

bObi comes with a mop extension and 2 mini mop cloths that may be attached to her. bObi can mop at the same time as she is sweeping, vacuuming, and disinfecting! The microfiber mop cloths included with bObi may be used dry or damp - with water or your favorite cleaning product - to remove stains from tile, laminate, concrete, wood, and any other hard flooring.

Attach bObi's mop



1 Turn bObi upside down and line up the flat side of the attachment with the two clear plastic holders found on either side of the main brush.



2 Make sure the square notches on the sides of the trailing bar line up with the notches in the middle of bObi's holders.



3 Hold the mopping extension perpendicular to bObi's underside and apply light pressure downwards.

4 The mop will snap into place and lie flat along bObi's underside.

Detach bObi's mop



1 Grip the button on the curved side of the attachment to unlock it from bObi.



2 Lift the attachment upwards until it's perpendicular to bObi's underside, then pull up to detach.

3 Remove the cloth from the Velcro on the mop extension and wash after use if needed.

4 Remove the mop extension before bObi cleans the carpets.

Automatic Cleaning Schedule

bObi can be programmed to start working at a specific time of the day on as many days of the week as you want. Use the remote to program bObi's cleaning schedule.

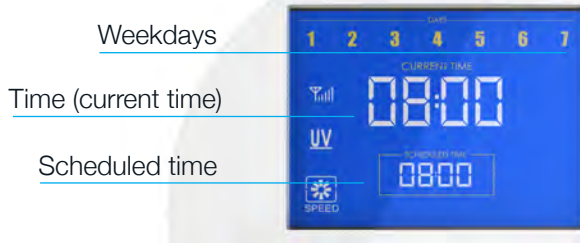

Weekdays

The numbers 1 to 7 on top of the screen represent days of the week. 1 stands for Monday and 7 is Sunday:

1 = Monday

2 = Tuesday

3 = Wednesday

4 = Thursday

5 = Friday

6 = Saturday

7 = Sunday

Current time

The current time is the top set of numbers indicated on remote's screen.

Scheduled time

The scheduled time is the bottom set of numbers indicated on remote's screen.

Time



bObi uses a 24-hour clock. If you want bObi to start cleaning at 8:00 AM set her schedule time to 08:00. If you want her to start at 8:00 PM, set it to 20:00.

8:00 AM is the default time. This time is displayed when installing batteries in the remote for the first time or after installing new batteries.

Quick reminder before programming bObi: bObi will clean on the scheduled time even if her bin or brushes require cleaning. Remember to check bObi's bin and brushes after every cleaning.

Setting the current time and weekday

To set the current time on bObi's remote, follow these steps:

1. Press the CUR TIME button.
2. The first (hour) digit under CURRENT TIME will start flashing. Use the FWD and BACK buttons to adjust the hour.
3. Use the LEFT and RIGHT buttons to scroll left and right to choose and adjust the other hour and minute digits.



4. Press CUR TIME again to save the time.
5. To set the current weekday, press CUR TIME again.
6. Press the LEFT button until the frame around number 1 on top of the screen starts to flash.
7. Press the FWD and BACK buttons to scroll through weekdays.
8. When you reach the current weekday, press CUR TIME again to save the day.

Programming bObi's cleaning schedule

Follow the steps below to schedule bObi's cleaning time and day(s):

1. Turn bObi ON and keep her close to the remote.
2. Press SCH TIME on her remote.
3. The first (hour) digit under SCHEDULED TIME will start flashing. Use the FWD and BACK buttons to adjust the time to the desired cleaning time.
4. Use the LEFT and RIGHT buttons to scroll left and right between the digits and change hour and minute settings.
5. Press SCH TIME again to save the scheduled cleaning time.
6. To choose the cleaning days, press SCH TIME again.
7. Press LEFT until the frame around the first day of the week, number 1, begins to flash.
8. Press the FWD and BACK buttons to scroll through days of the week.



9. To schedule cleaning for a certain day, press OK when the frame around that day is flashing. A day is selected when the number that represents that day is underlined. Keep pressing FWD and BACK to move between the days and press OK to select or deselect cleaning for each day.
10. Press SCH TIME when you are finished selecting days. bObi will confirm she has received her new schedule by chirping each time a new schedule is programmed.
11. If bObi is meant to work at the same time every day, just press the ALL/NONE button after setting her cleaning time schedule while the day of the week frame is flashing. All days will be underlined, which means bObi will start her work at the scheduled time every day. Press SCH TIME to save.
12. The ALL/NONE button can also be used to reset bObi's scheduled cleaning days. Remember, pressing ALL/NONE then SCH TIME when bObi has a preset schedule turns off cleaning on all days.

Maintenance

Dustbin

Remove and clean the dustbin

One of bObi's best features is her washable dustbin. For a quick clean, grasp and push down the button on the back of her dustbin, then pull the bin away from bObi to eject it while bObi is on the floor.

To remove the dustbin, push down the eject button and pull the bin away from bObi



Do not remove the dustbin while bObi is upside down

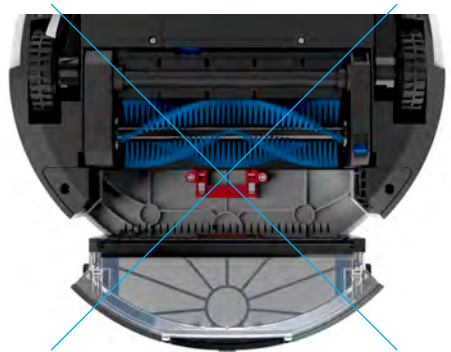

To open the dustbin, hold it with both hands and press down the two colored clips on the sides of the dustbin to release its plastic door.

For a quick clean, use the cleaning brush to remove the remaining dirt and dust from the dustbin.

Remove and clean the filter

Turn the dustbin around (HEPA filter on top), hold the dustbin with both hands, and press down on the two colored clips on the sides of the dustbin to release the filter cover. With the filter case open, take the HEPA filter out and clean it using the cleaning tool, or a flow of air.

It is recommended that you change bObi's HEPA filter every few months depending on the frequency and intensity of cleaning.



Wash the dustbin

To wash the dustbin, eject the vacuum motor first by pushing the button on top of the dustbin.



With the motor and filter removed, the dustbin may be washed with water. You can also sanitize it with your choice of cleaning product (do not use harsh chemicals). Do not wash or wet the vacuum motor.

Reinstall the dustbin

Place the vacuum motor and filter back in place and flip the filter cover and the dustbin's cover back so they snap into place. To reinstall the dustbin, make sure the side that encloses the filter faces down, put bObi upright and slowly slide the dustbin in until it clicks and locks properly. Be careful not to damage the two metal connectors that are located on bObi.



If bObi's dustbin is not fully engaged, her motor may not make proper contact with the battery's electrodes. If bObi does not resume her normal work after reinstalling her bin, or if she shows error 5 (Er 05) and her vacuum motor is not turning on, remove her dustbin, check that the connecting prongs on bObi (image on the right) are not stuck and can spring freely, then replace the dustbin securely.

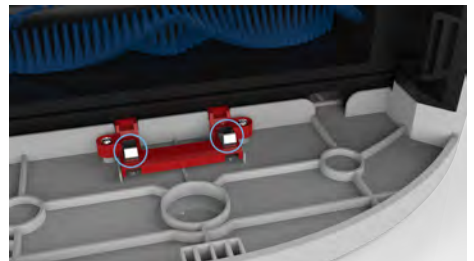

Main Brushes

bObi uses a dual brush cleaning system. It is recommended that you open and clean bObi's main brushes after every 2-3 cleaning tasks. To open and clean the brushes:

1 Flip bObi over, so the front wheel is farthest from you and the side brush is on your left.

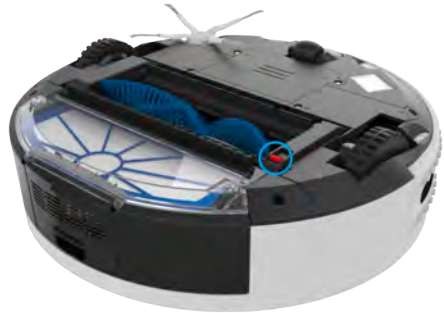

2 Open the locking bar by pressing the red latch found to the right side of the main brushes, then lift the locking tab up from its lower end. Take out the brushes by lifting the exposed side up. Then pull to the right.



3 Use the cleaning tool, paper towels, and a can of compressed air to fully remove dust, dirt, and hair from the brushes as well as the brush holders inside of bObi.



4 If there is anything wrapped around the bristles or brush ends (hair, strings, etc.), use scissors to cut it out and then use the cleaning tool and a paper towel to remove it.



5 Remove the circular rubber brush ends on each of the brushes. Clean them off and put them back on the brushes.

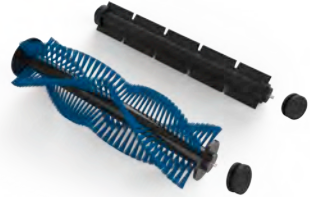

6 Lower the brushes into place starting with the left side then the right. Press the brushes down gently until they are secured in place. Lower the locking tab until it clicks into place.

Side Brush

bObi uses her side brush to clean corners and along walls. Dirt and dust trapped around the brush can deteriorate its ability to move freely and reduce bObi's efficiency. To clean the side brush:

1 Unscrew the screw in the center of the side brush with a Phillips screwdriver.

2 Remove the side brush and clean it. Use the cleaning tool to remove any debris around the side brush's anchor.

3 Replace the side brush and secure it with the screw.



UV Light

bObi's sterilizing UV light is located on her underbelly.

The UV light is automatically turned ON when bObi starts cleaning. Toggle the UV light ON or OFF by pressing the UV button on the remote.



Caution: Do not look directly into the UV light.

Front Wheel

Use the cleaning tool to clean the front wheel.

To remove the wheel, position a flat screwdriver under the front wheel. Pop the entire wheel assembly out with an upward motion and clean the wheel and its internal parts. Replace the wheel with gentle pressure until it clicks into place.



Sensors

Cleaning bObi's sensors

Dirt and dust on bObi's bottom and side sensors can reduce her performance. Regular cleaning of the sensors ensures that bObi keeps working at her best. Use a soft cloth or cotton swab slightly moistened with cold water or alcohol to wipe along bObi's surface and around and underneath her belly, especially on the bumper and floor detection sensors on bObi's bottom.



Blindfold stickers

Dark-colored carpets and certain patterns can seem like edges to bObi's infrared sensors. If you notice that bObi stops with error1 (Er 01) on your carpet, you can try "blindfolding" her by covering the 4 floor detection sensors underneath her. The floor detection sensors are on the front and sides of bObi's bottom when you flip her over. Just make sure bObi is not getting anywhere near stairs or sharp edges when blindfolded, as she can fall.



Storing bObi

bObi should not be left unused with her power switched ON for more than one week. If you are not using bObi for an extended period of time, switch her OFF. Then, unplug the charging station, remove bObi's battery, and store everything in a dry place at room temperature.

Do not leave bObi in direct sunlight.

Troubleshooting

Likely Cause(s) for bObi's Trouble/Error Codes

When bObi faces an uncomfortable situation, she will try to notify you of the issue. If she ever stops in the middle of her cleaning with the error sign (Er) lit on her remote, read the two-digit code on the remote's display. Below are the codes, the likely cause of the trouble, and what to do in the case of each code. Additionally, bObi is equipped with a self-checkup feature that allows you to test the functionality of her various parts and sensors. If the problem is not resolved, please contact us at support@bobsweep.com.

Not a fan of reading? For a complete archive of bObi's how-to videos, troubleshooting and checkup guides, go to <http://owners.bobsweep.com> or scan this smart-phone barcode:



Error Code 1 (Er 01)

bObi cannot see! Her ground/edge detecting sensors (the 4 sensors on the front and sides of bObi's bottom) are blocked or dirty.

What to do:

What kind of flooring are you using bObi on? On dark carpets or rugs use bObi's blindfold stickers as instructed to resolve the error.

If the flooring is not dark or patterned, turn bObi around and wipe sensors with a clean, dry cloth until they are completely clean. If the issue persists, run a checkup test on bObi.

If bObi needs a change of ground/edge detecting sensors contact our support team. Alternatively, you can change bObi's sensors at home. All you need is a new set of ground/edge detecting sensors and a Philips head screwdriver. Go to bObi's owners' corner at owners.bobsweep.com for a video guide and step-by-step instructions.

Error Code 2 (Er 02)

Error code 2 relates to bObi's main brush system and can appear when one or both main brushes have difficulty rotating.

What to do:

Open and take out the main brushes, and clean them thoroughly from end to end. If you see congestion in the main brush motor area try to clean it using a sharp-ended tool like a pair of tweezers. If the congestion is not easily removable, bObi's main brush motor may need to be replaced. For a video guide and step-by-step instructions, refer to bObi's owners' corner at owners.bobsweep.com.

On shag carpet or rugs take out the rubber main brush and use bObi's soft-bristled blue main brush. If the problem persists on hard flooring with a clean main brush and no congestion in the brush motor area, it is likely that bObi has an internal problem.

Contact support team for help.

Error Code 3 (Er 03)

If bObi's battery is 100% empty, she won't be able to charge using her station and may show error 3 (Er 03) on her remote.

What to do:

Plug bObi directly into the adapter using the inlet below her ON/OFF switch. bObi's screen will flash and turn on, and she will make a short, chirping sound. Let bObi sit for about 30 minutes then unplug her. Turn the side switch OFF, then back ON, and then put her on her station to complete charging.

Error Code 4 (Er 04)

Error code 4 pertains to an issue with bObi's left and right wheels, or blockage in her main rubber brush. The issue may simply be a jam in one or both wheels, or bObi may have an electronic problem that is keeping her right wheel from moving freely.

What to do:

Check bObi's wheels for jamming. Open the wheels and use compressed air to remove dust or debris. Check bObi's main brush and remove dirt, dust, or entanglement. If error 4 (Er 04) occurs on a soft or plush carpet, remove bObi's rubber brush and restart.

If this does not solve the problem and bObi still shows an error, perform a checkup test to see how the wheels and brushes respond to the test.

Contact support if needed.

Error Code 5 (Er 05)

Error code 5 means that bObi's dustbin is installed improperly or the vacuum motor's contact points are blocked or bent.

What to do:

Take out the dustbin, empty it, and clean the connector electrodes. Check that the connector electrodes (two metal prongs on bObi) spring freely and are not stuck or bent. If one or both of the electrodes is stuck, use a screwdriver to gently pull the metal tab up and out to free it. Carefully reinstall the dustbin while bObi is in an upright position, ensuring that it is fully engaged.

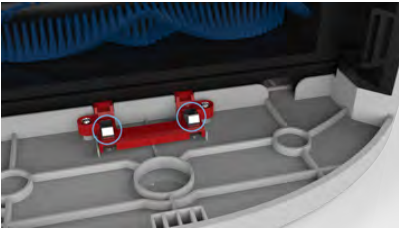

Checkup Guide

If you notice that bObi is not working in her usual way or repeatedly runs into a certain error, you may want to perform a checkup test to find out what is causing the issue. bObi's remote can be used to test all of her sensors and electronic parts in the span of a few minutes. If bObi does not produce the results as described during any of her tests, contact our support team for further assistance.

To begin the checkup, make sure the side power button on bObi is turned OFF. Bring bObi near the remote.

Put bObi in checkup mode

Press and hold the OK button on the remote while you switch bObi's power back ON. Continue holding the OK button. The three touch buttons (GO!, WAFFLE, JUICE) on bObi's cover will start flashing. While the touch buttons are flashing, simultaneously press the WAFFLE and JUICE buttons on bObi's cover with the OK button on the remote still held down. When bObi makes two beeping sounds, release the OK button and you will notice that all the digits on her remote become zeroes. bObi is now in test mode. While in this mode, the three buttons on bObi's cover (GO!, WAFFLE, JUICE) stay on, and the 5 LED lights above the buttons flash sequentially.

You may switch between different tests by pushing the LEFT button on the remote. Alternate between different parts of a certain test by pushing the RIGHT button, which will change the digits to let you know what part of bObi is being tested.

Test bObi's floor detecting sensors

Remove bObi's side brush before testing her floor sensors.

bObi's floor detection sensors are the first item tested when bObi is put into test mode. In this test mode, numbers 1-6 located on top of the remote represent bObi's 4 infrared floor detection sensors and the two floor detection sensors located in bObi's left and right wheels. The test mode indicator reads 0000.

With bObi on the floor, numbers 1, 2, 3, and 4 should be underlined to show that bObi's floor detection sensors are working.

When you lift bObi up, the lines under numbers 1,2,3, and 4 will disappear and new ones will show up underneath the numbers 5 and 6. This means that the left and right wheels are off the floor, and floor detection sensors are working properly.

bObi's firmware version

After testing the floor detection sensors, and while in test mode 0000, press LEFT on the remote. The number 0001 will appear on the test mode indicator. The main 4-digit number on the screen indicates the firmware version of your bObi.

Test the battery

While in test mode 0001, press LEFT on the remote. The number will change to 0002. In this mode, the main 4-digit number on the screen indicates the voltage of bObi's battery in millivolts (mv). Under normal circumstances this number ranges between 1400 and 1600. If the number on the screen changes to 0000, it means bObi's battery is not working or has a loose connection. Open the battery compartment and check the battery.

Test bObi's wall detecting sensors

After testing the floor detection sensors, press RIGHT on the remote. The number 0100 will appear on the test mode indicator. Use a piece of paper, a roll of paper towels, or a flat white surface to imitate a wall in front of bObi. Drag it from the left side of the bumper around to the right side until you reach the power switch. Numbers 1-5 on the remote will become underlined one by one as you do this. Ignore the numbers on the large 4-digit number in the middle of the screen.

Test the touch sensors

80 tiny touch sensors surround bObi's front. Test them while in same test mode as the wall detection sensors (0100). Press on any of the small points on the left side of the bumper and the number 6 will be underlined. Do the same to the right side and the number 7 will be underlined.

Usage counter

To find out how many times bObi has been used (charged in full and ran out of charge) either manually or automatically, press RIGHT on the remote while in test mode 0100. The test mode indicator becomes 0200. In this mode, the main 4-digit number on the screen indicates the number of times bObi's battery has been charged.

Test the left and right wheels, brushes, and vacuum motor

Turn bObi upside down and lay her on a flat surface. In test mode 0200, press RIGHT on the remote to enter test mode 0300. In this mode you can test the left and right wheels, main and side brushes, and vacuum fan's motor. As soon as she enters test mode 0300, bObi's wheels drive forward, her brushes move, and the vacuum fan starts to work.

Left Wheel: Digits 1 and 3 become underlined, indicating that both left and right wheels are working. The main 4-digit number on the remote's screen shows the current of bObi's left wheel. Normal current ranges between 0020 and 0110.

Right Wheel: Press LEFT on the remote to enter test mode 0301. Digits 1 and 3 will still be underlined; this time the main 4-digit number on the remote's screen shows the current of bObi's right wheel. Normal current ranges between 0020 and 0110.

Main Brush: In test mode 0301, press LEFT on the remote to enter test mode 0302. The wheels will stop moving. The main 4-digit number on the remote's screen will show the current of bObi's main brush. Standard current for the brushes should be below 0260mA.

Vacuum Motor: After testing the brush, press LEFT on the remote again and you will see the digits 0303 in the test mode indicator. The vacuum motor will start working and the main 4-digit number on remote's screen will show the current of the vacuum motor. Standard current range for the vacuum motor is between 0160 and 0200mA.

Test the charging station

The final part of the checkup tests bObi's ability to charge. To begin this test, press RIGHT on the remote so that bObi enters test mode 0400. The main 4-digit number in the center of the remote's screen should show 0000 when bObi is not on her charging station. Place bObi on her charging station, and a number between 0400 and 0800 should appear in place of the zeroes.

When you are finished with the test, turn bObi's side power button OFF to leave the checkup mode. When you switch it back ON, bObi will return to her normal working mode.

If everything responds properly, bObi's internal parts are working correctly. Contact our helpful support team at support@bobsweep.com if you have a question or need help with bObi.

Support and Warranty

Warranty Information

All bObsweep products purchased from an authorized seller and used anywhere in the world include a one 1-year limited warranty on parts and labor. This includes the battery. The warranty does not cover consumable parts (brushes, filters, mop). Additional coverage plans are available for purchase at:

<http://bobi.bobsweep.com/bobi-support-warranty/coverage-plans>

Even after bObi's warranty is over, we will share the maintenance costs with you. During the first five years of your purchase, we will replace/repair bObi when needed and subsidize the replacement/repair charges. The exact amount of our co-pay may vary. We will cover no less than 25%.

To receive warranty services you must register bObi online. You must also keep the original receipt of your purchase.

To register bObi visit:

<http://bobi.bobsweep.com/bobi-support-warranty/register-bobi>

bObi's Cleaning Behavior

Most of the time, bObi can be left on Go! cleaning mode to clean without supervision. In this automatic cleaning mode, bObi detects dirtier areas as she crosses them, and gives them more attention.

Sometimes bObi may seem to avoid one area of a room for a while, but be patient while she searches out dirt particles in her own way. bObi's pattern may look quite different from the way a human would clean: She sometimes draws short lines that are straight. Or she may go back and forth in the middle of the room, zigzagging over a small area. Rest assured, frequent directional changes are normal for bObi while she changes cleaning modes and algorithms. It is best to let bObi work in her own way even if her movements appear odd. Moving bObi around, manipulating her movements excessively, or picking her up will disrupt her cycle. If you leave bObi to do the job on her own, you will notice the excellent results when you open the dustbin at the end of her cleaning cycle. If you wish to control bObi's movements to cover/avoid a certain area, we recommend that you only do so using her remote. If the remote seems unresponsive at any time, check to make sure it is synced up with bObi. If your rooms are divided by ledges higher than bObi is able to climb, you may gently push her over.

Although bObi is capable of transitioning between rooms and most floor types, this does not mean that she always chooses to move onto the next area when she arrives at a transition. She may appear to be ignoring some spaces or spending too much time in others, but rest assured that her algorithms are designed to render an efficient cleaning job by the end of a full cycle.

bObi FAQs

1. Where can I find bObi's training videos?

bObi's "how-to" videos can be found at bObi's owners' corner at <http://owners.bobsweep.com>

2. How long should bObi's battery last?

bObi's running time depends on the type of floor she is cleaning, the speed she is set on, the age of the battery, etc. On average she works anywhere between 1 to 1.5 hours on a full battery. When her battery life falls below 15%, she automatically starts to look for her charging station. Before her first use, it is best to allow bObi to charge for 12-14 hours.

3. How often should I empty the dustbin?

It is recommended that you empty bObi's bin after one or two cleaning jobs but this mainly depends on the volume of cleaning that she does. The good news is you can wash bObi's bin under running water! Simply detach the vacuum motor from the bin and the bin is ready to wash!

4. How often do I need to change bObi's HEPA filter?

It is recommended that you clean bObi's HEPA filter every week and replace the filter every 3-6 months.

5. How often should I clean bObi's brushes?

bObi's brushes do a lot of work picking up hair and larger debris, so it is recommended that you clean the main and side brushes every 1 to 4 uses.

However, if you clean them more frequently, bObi will be able to store more dirt in her dustbin, rather than on her brushes. If you notice a thick covering of hair, dust, and debris on her brushes, remove and clean them. Remember to clean the interior of bObi where the brushes connect and where the dust flows to the dustbin to ensure they stay in good condition for a long time.

6. My bObi won't turn on no matter what I do.

If bObi has not been charging for a long time, and does not turn on when pressing the side power button or placing her on her charging station, it's likely that the battery has been drained too low for bObi to operate. To recharge her, unplug the adapter that normally attaches to the charging station and plug it directly into the inlet on bObi's side. Then, let bObi recharge fully before using her again. Afterwards, you will be able to charge bObi manually or automatically using her charging station. If you place bObi on her charging station, always make sure to turn her ON first, to activate the charging plates on her bottom. When bObi is charging, the battery bars on her cover blink

7. Why is my bObi beeping?

If bObi is left ON but she is not cleaning or charging, she makes a beeping sound once every five minutes to warn you that she is left unattended and her battery is being drained. Place bObi on her station, or turn her OFF completely by using her side power button. You will have to switch this button ON the next time you want bObi to clean.

bObi also makes this noise when she encounters problems cleaning and needs your assistance. In addition to the chirp, there will be an error number (Err) on the remote's display, which lets you know why bObi has stopped. You can decode this message by consulting the Troubleshooting section of this manual.

8. bObi is having trouble landing her charging station. Where is the best place to put the station?

bObi finds her station through the transmission of WiFi signals. bObi will park on her station more easily when the station is placed near the perimeter of the room with plenty of space in front, so that she may adjust her distance from the station and make a perfect landing. Place the station on a flat surface like hardwood or tile flooring instead of carpet. To facilitate bObi's work, find a spot for the charging station where bObi has a higher chance of passing through.

9. I left bObi's brush in for multiple cleans and am having problems removing it.

If the main or side brushes are difficult to remove, it is likely because hair, string, or other debris have been caught in them and are clogging the areas where they attach to bObi. You can use scissors to cut the hair wrapped around either brush, until you are able to remove it.

10. bObi is getting stuck under some of my furniture or travelling into areas with wires that tangle up the brush. How can I stop her from going into these areas?

bObi is determined to cover all the spaces she can find in your home. Because of this, she might get herself into trouble once in a while. If she finds her way under a piece of furniture where she can barely fit, she may struggle to get out. If there is only one open entrance, bObi may take a few minutes to figure out how to escape on her own. You do not have to assist her when this happens, unless you would like to use the remote to steer bObi out of her struggle zone.

11. Why does bObi start even though I did not tell her to clean?

bObi may begin cleaning on her own if you put her remote into auto-resume (Finish Fueling and Go) mode, or if she is scheduled to clean at a certain time. First, look at the display on bObi's remote. If the scheduled cleaning time slot does not show a 4-digit number but that the code "FFGO," then bObi is programmed to start working immediately once she is finished fueling.

To reset this feature and cancel the auto-resume, press the SCH TIME button on the remote, then press STOP.

12. When is a good time to use the waffle function?

The Waffle function is best for cleaning a small area with a large amount of dirt or dust. It is a great way to target only one area that has become dirty, such as a spill that must be swept or mopped in an otherwise clean area. It is also very effective when mopping, to minimize streaking on tile or hardwood floors.

13. My bObi is stopping and showing an Error Number on remote's screen, how can I fix this?

To understand bObi's language, consult the Troubleshooting section of this manual for the cause of the problem as well as its solution.

14. Where can I buy spare parts?

Extra parts are available for purchase on our owners website, owners.bobsweep.com. With bObi's modular design and our how-to videos, you can change each individual part easily if it gets old or damaged.

15. I have a question and need to contact bObsweep's support team.

Need help with bObi? Our devoted team is ready to help you! You can reach us by phone or e-mail.

Call us toll free [1-888-549-8847](tel:1-888-549-8847) for support in Canada and the United States. Or, email us at support@bobsweep.com. Our goal is to get back to you within a day.

To find bObi's how-to videos, repair videos, troubleshooting videos, and to connect with your extended bObsweep family members and fellow Bob and bObi owners, visit bObi's owners' corner at <http://owners.bobsweep.com>.

sealed with care
bObsweep

® and © bObsweep Inc.all rights reserved.