

THIS INSTRUCTION BOOKLET CONTAINS **IMPORTANT** SAFETY INFORMATION. PLEASE READ AND KEEP FOR FUTURE REFERENCE.

ESTE FOLLETO DE INSTRUCCION CONTIENE INFORMACION **IMPORTANTE** DE SEGURIDAD. POR FAVOR LEA Y GUARDE PARA REFERENCIA FUTURA.

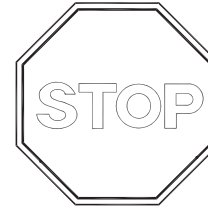

DO NOT RETURN PRODUCT TO THE STORE
Individual stores do not stock parts.

NO DEVUELVA ESTE PRODUCTO A LA TIENDA
Las tiendas no almacenan partes.

Lot Number / Número de Lote: _____

If a part is missing or damaged, call our toll-free customer service line. We will gladly ship your replacement parts **FREE** of charge.

Si faltan partes o piezas, o éstas están dañadas, llame gratis al teléfono de servicio al cliente. Con gusto le enviaremos las partes sin cargo alguno.

Need Parts or Assistance?
Necesitas partes o asistencia?

1-800-489-3351

or access our website
o visite nuestra página de internet

www.altrafurniture.com

For prompt, reliable service please have your assembly manual ready.
Para obtener servicio rapido y confiable, por favor tenga esta manual a la mano.

Recommended # of people needed for assembly: 2

El número recomendado de personas necesarias para el montaje: 2

Thank you for purchasing from Altra Furniture.
Visit www.altrafurniture.com to view the limited
warranty valid in the U.S. and Canada.

ALTRA FURNITURE CUSTOMER SERVICE

Gracias por haber comprado de Altra Furniture.
Visitar www.altrafurniture.com para mirar la garantía
limitada válida solamente en U.S.A y Canada.

SERVICIO A LA CLIENTE DE ALTRA FURNITURE

Before starting - Antes de empezar.

- Read each step carefully before starting. It is very important that each step of instruction is performed in the correct order. If these steps are not followed in sequence, assembly difficulties will occur.
Leer con cuidado cada paso antes de empezar. Es muy importante de ejecutar cada paso en el orden correcto. Si los pasos no están ejecutados en secuencia, ocurrirá dificultades en el montaje.
- Make sure all parts are included. Most board parts are labeled or stamped on the raw edge. Asegurar que todas las piezas son incluidas. La mayoría de las tablas tienen las etiquetas o los sellos en el lado sin acabado.
- Work in spacious area, preferably on a carpet, near the place the unit will be used.
Trabajar en una área espaciosa, preferible sobre alfombra, cercas del lugar donde se va a usar el mueble.
- Have the following tools close at hand.
Tener las herramientas siguientes cerca de la mano.
- Do not use power tools to assemble your furniture. Power tools may strip or damage the parts.
No use herramienta eléctrica para montar su unidad. Las herramientas eléctricas pueden dañar las piezas.

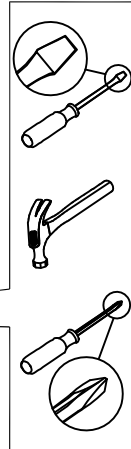

Call us at: 1-800-489-3351
Llamar a: (in U.S.A. only)
(Solo en U.S.A)

Monday - Friday
9:00 am - 5:00 pm
Central Time



Fax: 1-636-745-1005
Fax:

Lunes - Viernes
9:00h - 17:00h
Tiempo Central



Visit our Website:
Visitar nuestro website: www.altrafurniture.com



Write to: ALTRA FURNITURE
Escribir a: 410 East 1st Street South Wright City, MO 63390 USA
Attn: Service Dept.

HELPFUL HINTS

- Visit our website for assembly video clips.
- Identify, sort and count the parts before attempting assembly.
- Call our toll free number if you need assistance identifying parts.
- Compression dowels are tapped in with a hammer.
- Slides have lips only on the right side.
- Cam locks that are properly fastened on a horizontal board will face toward the center of the unit, on a vertical board the point on the lock will face the bottom.
- Back panels provide stability and support. Use all the nails provided.
- When tapping nails into a board, be sure there are equal margins on all sides to square the unit.
- Units without the back panel installed may collapse.
- Clean the product with your favorite furniture polish and a soft cloth. **DO NOT USE** harsh chemicals or abrasive cleaners.
- Move your new furniture carefully, with two people lift and carry the unit to it's new location.
- Never push, drag or scoot your furniture (especially on carpet).
- Your furniture can be disassembled and reassembled to move.
- Additional parts are available for a nominal fee.

NOTES UTILES

- Visitar nuestro website para mirar los videos cortos del montaje.
- Identificar, clasificar y contar las piezas antes de intentar el montaje.
- Llamar gratis a nuestro número de servicio si necesite ayuda con identificar las piezas.
- Las clavijas de compresión se taladran con un martillo.
- Las correderas sólo tienen las proyecciones en el lado derecho.
- Las cerraduras de leva que se atan propiamente en una tabla horizontal se puntan al centro de la unidad, y las en una tabla vertical se puntan al fondo.
- Los paneles traseros se mantienen la estabilidad. Usar todos los tornillos proporcionados.
- A taladrar los tornillos en una tabla, asegurarse que hay márgenes iguales en todos los lados para cuadrar la unidad.
- Las unidades sin panel trasero pueden derrumbarse.
- Limpiar la unidad con su pulimento favorito de mueble y una tela suave. **NO UTILIZAR** productos con químicos duros o abrasivos.
- Mover su mueble nuevo cuidadosamente, con dos personas levantar la unidad a su nuevo lugar.
- Nunca empujar o arrastrar su mueble (especialmente en alfombra).
- Poderse desmontar y volver a montar su mueble de para mover.
- Piezas adicionales están disponibles para una cuota nominal.

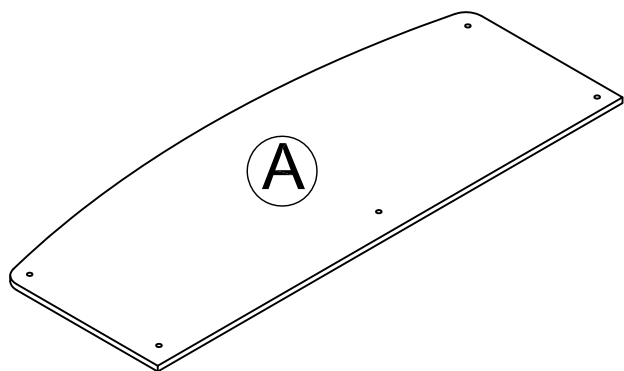

TOP
Panel superior
T1195096010

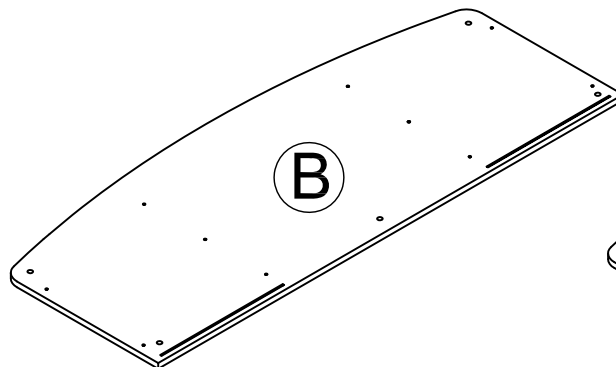

MIDDLE TOP
Superior medio
T1195096021

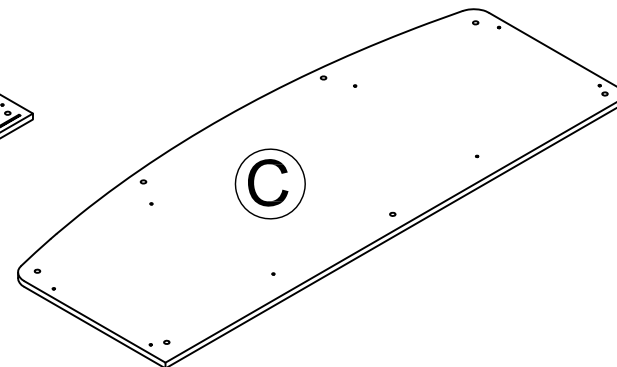

BOTTOM
Base
T1195096031

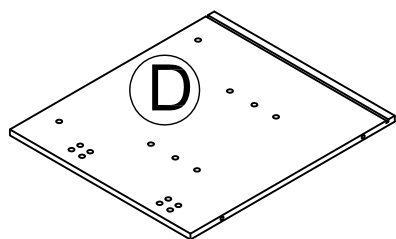

LEFT SIDE PANEL
Panel izquierdo
T1195096041

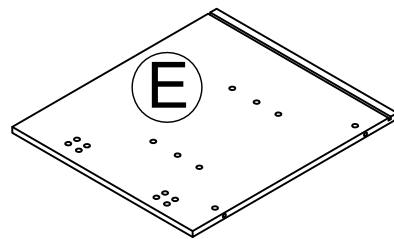

RIGHT SIDE PANEL
Panel lateral derecho
T1195096051

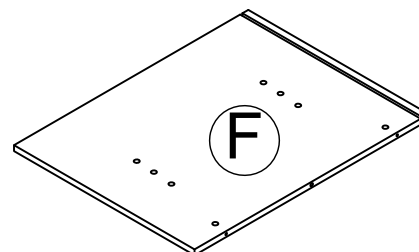

LEFT PARTITION
Partición izquierdo
T1195096061

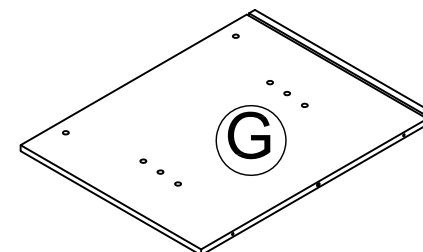

RIGHT PARTITION
Partición lateral derecho
T1195096071

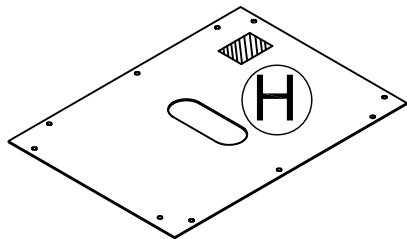

BACK PANEL
Panel trasero
T1195096080

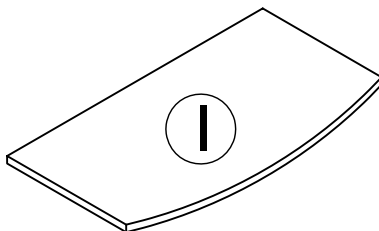

SHELF
Repisa
T1195096090

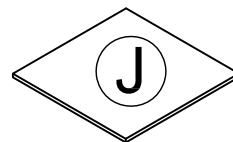

SHELF
Repisa
T1195096100
2PCS

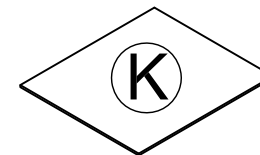

BACK PANEL
Panel trasero
T1195096110
2PCS

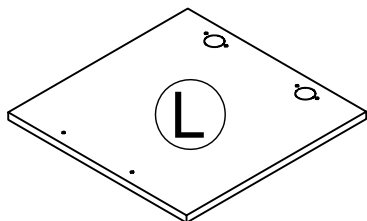

LEFT DOOR
Puerta izquierda
T1195096120

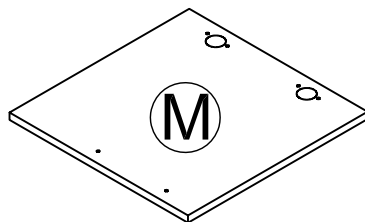

RIGHT DOOR
Puerta derecha
T1195096130



SUPPORT TUBE
Tubo soporte
T1195096140
5PCS



LEG
Pate
T1195096150
7PCS



WARNING LABEL
TTL1195

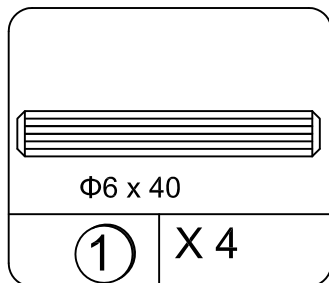

WOOD DOWEL
Clavija de madera
TTL4008

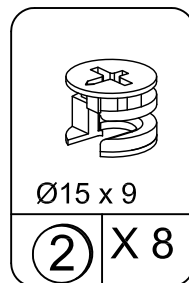

CAM LOCK
Tornillo de cerradura
TTL6025

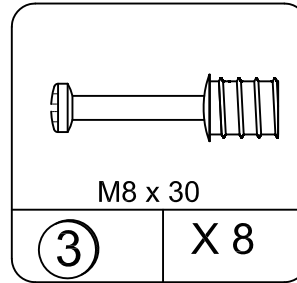

CAM BOLT
Tornillo de rosca
TTL6026

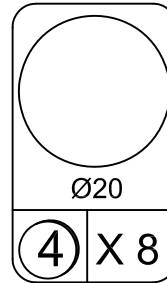

COVER
Cubre
TTL6010

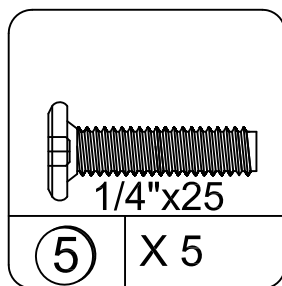

BOLT
Tornillo
TTL2020

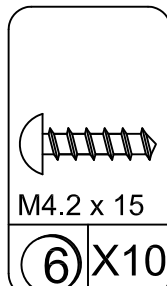

SCREW
Torillo
TTL5001

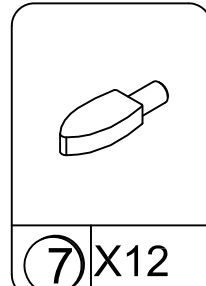

SHELF SUPPORT
Soporte de repisa
TTL5008

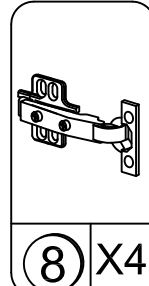

HINGE
Bisagra
TTL5004

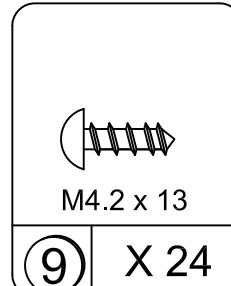

SCREW
Torillo
TTL5005

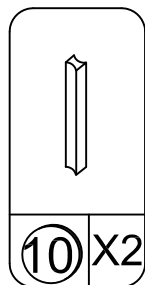

HANDLE
Perilla
TTL9105

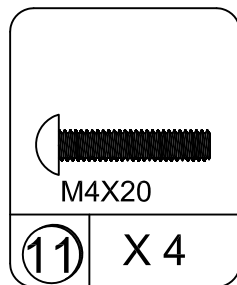

BOLT
Torillo
TTL5007

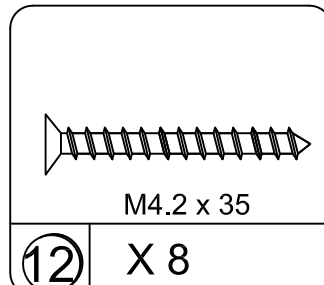

SCREW
Torillo
TTL5002

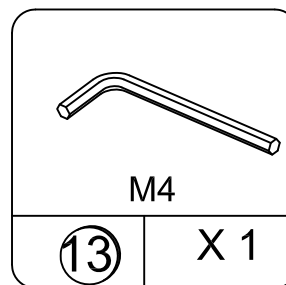

HEX KEY
Llave en L
TTL5003

This illustration shows how the CAM fastening system works.

Esta ilustración muestra como funciona el sistema de fijación de leva.

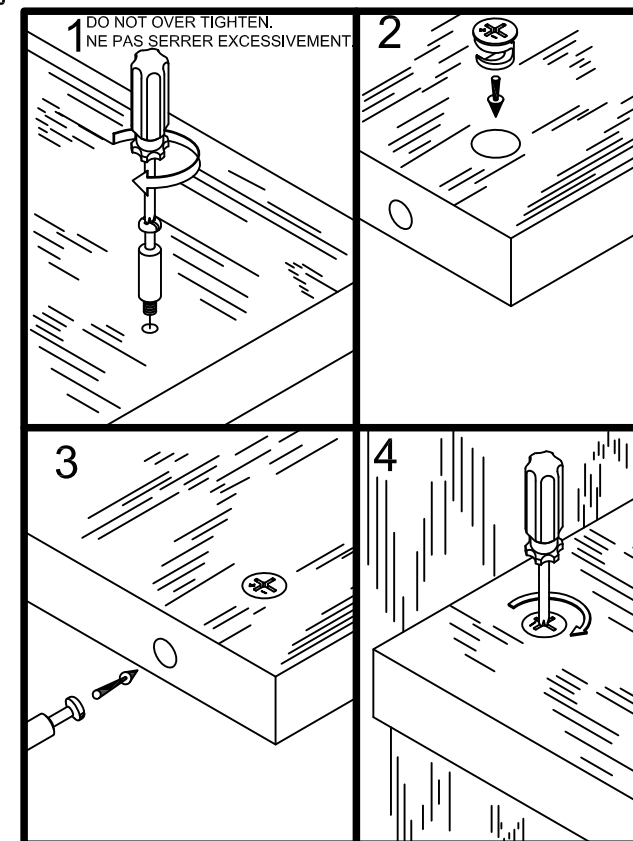

To view a video on how the CAM fastening system works, download a free QR-reader on your smartphone, then scan the code.

Para ver un video de como funciona el sistema de sujeción CAM, descargue una aplicación gratis que podra ver en su teléfono movil, entonces escnee el código.

1

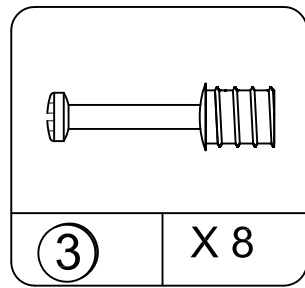
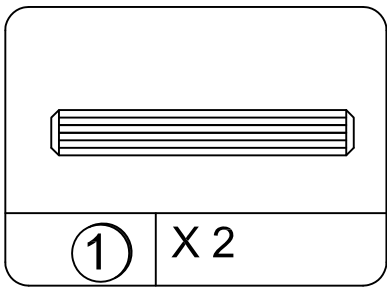
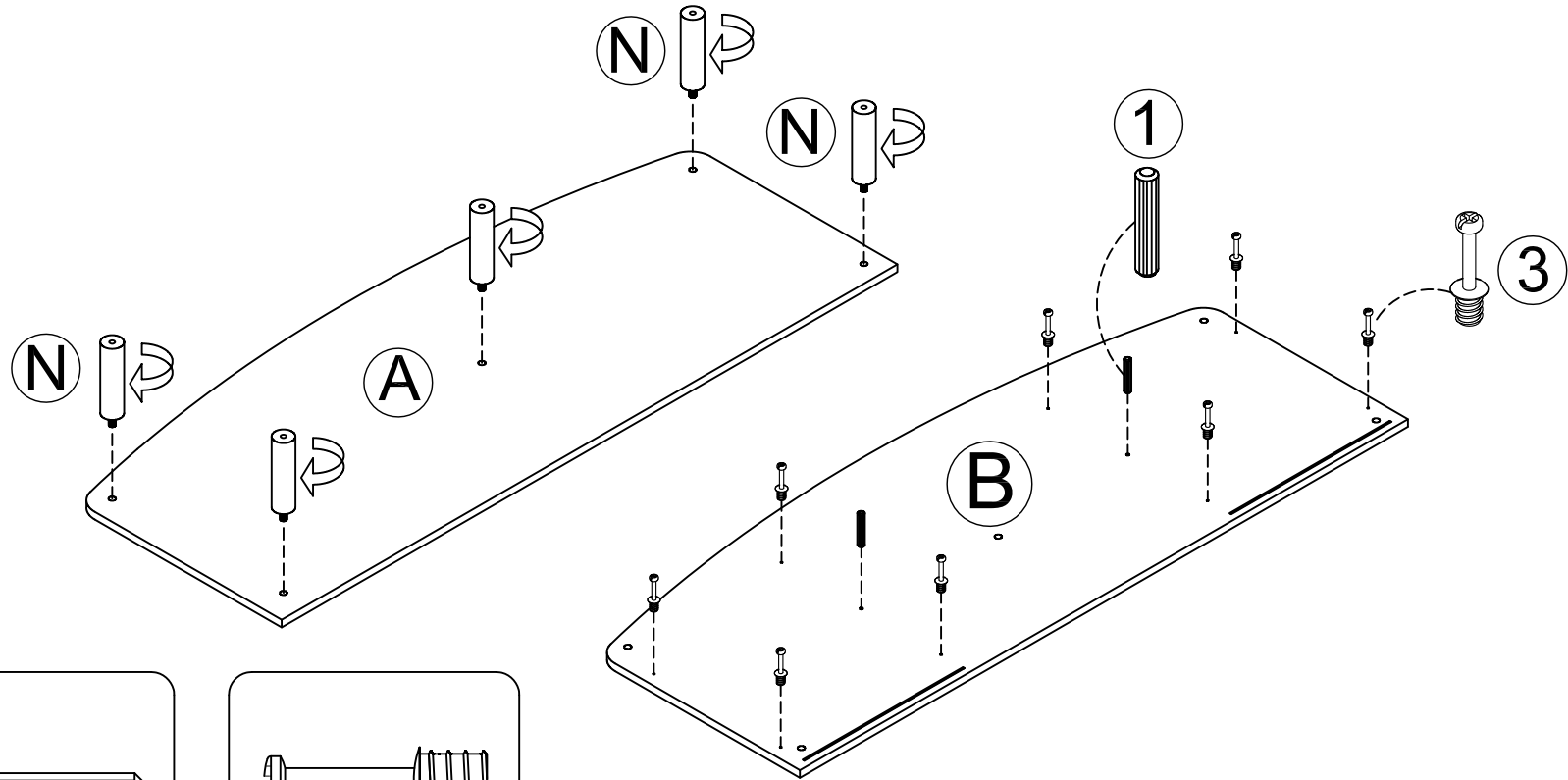

2

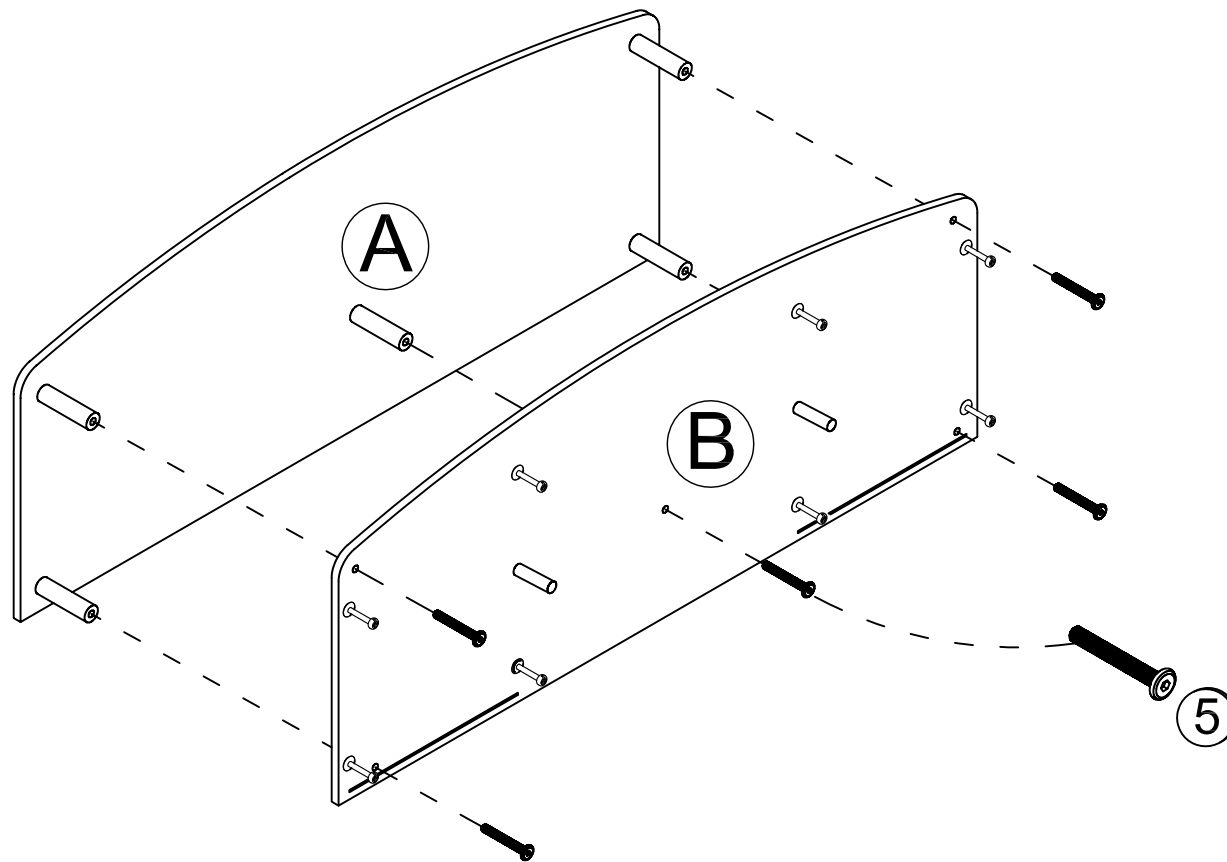
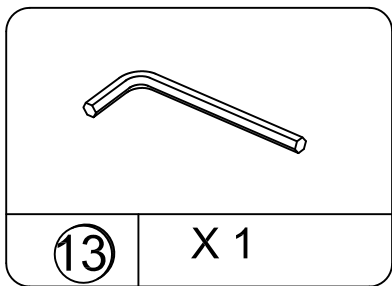
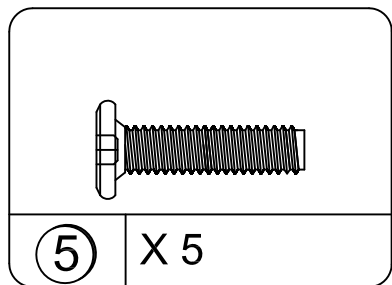

3

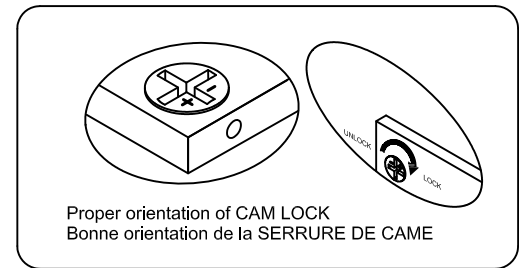
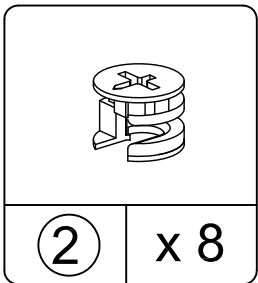
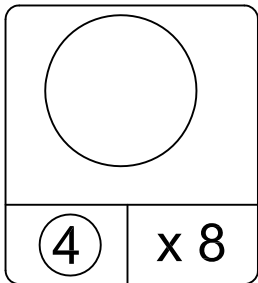
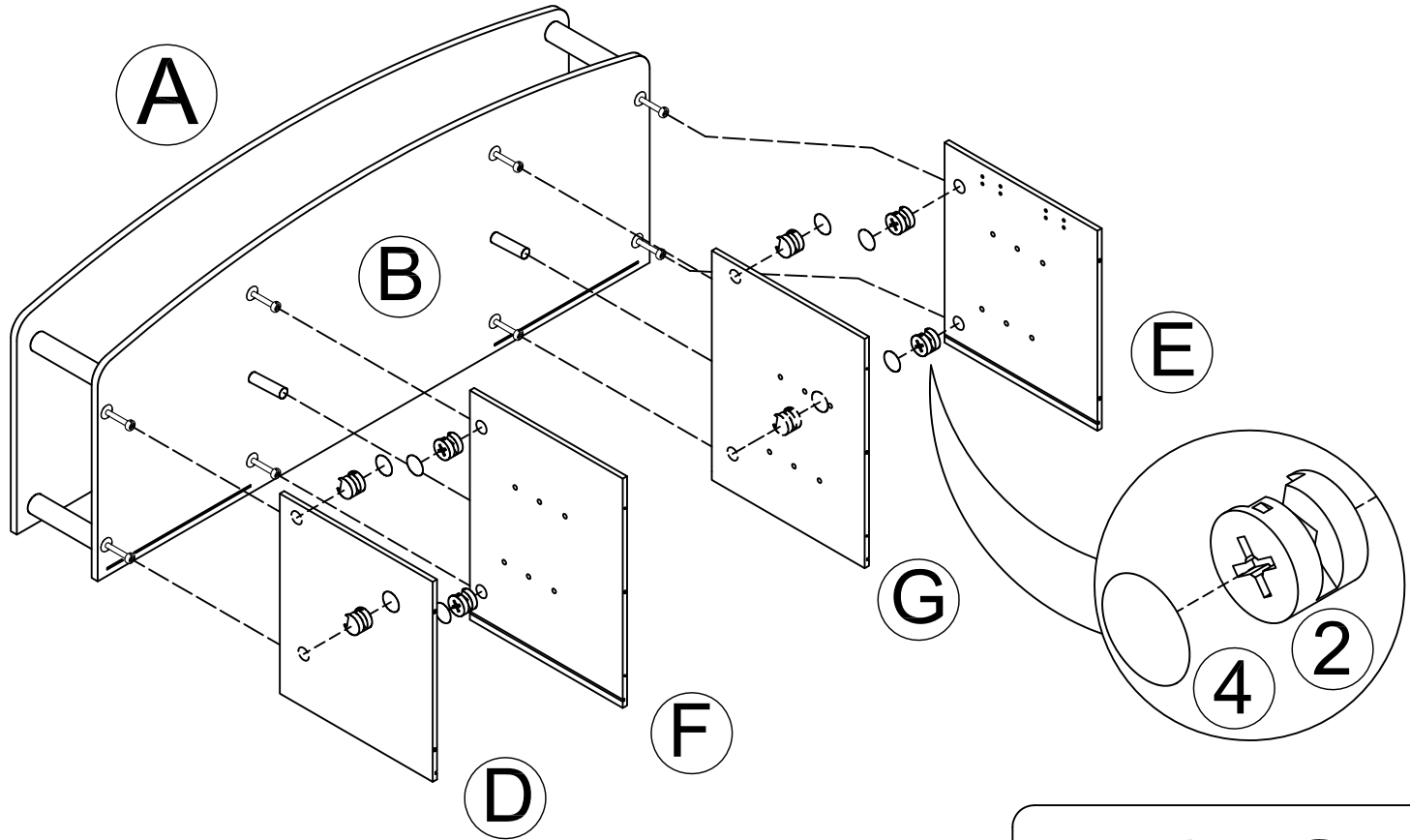

4

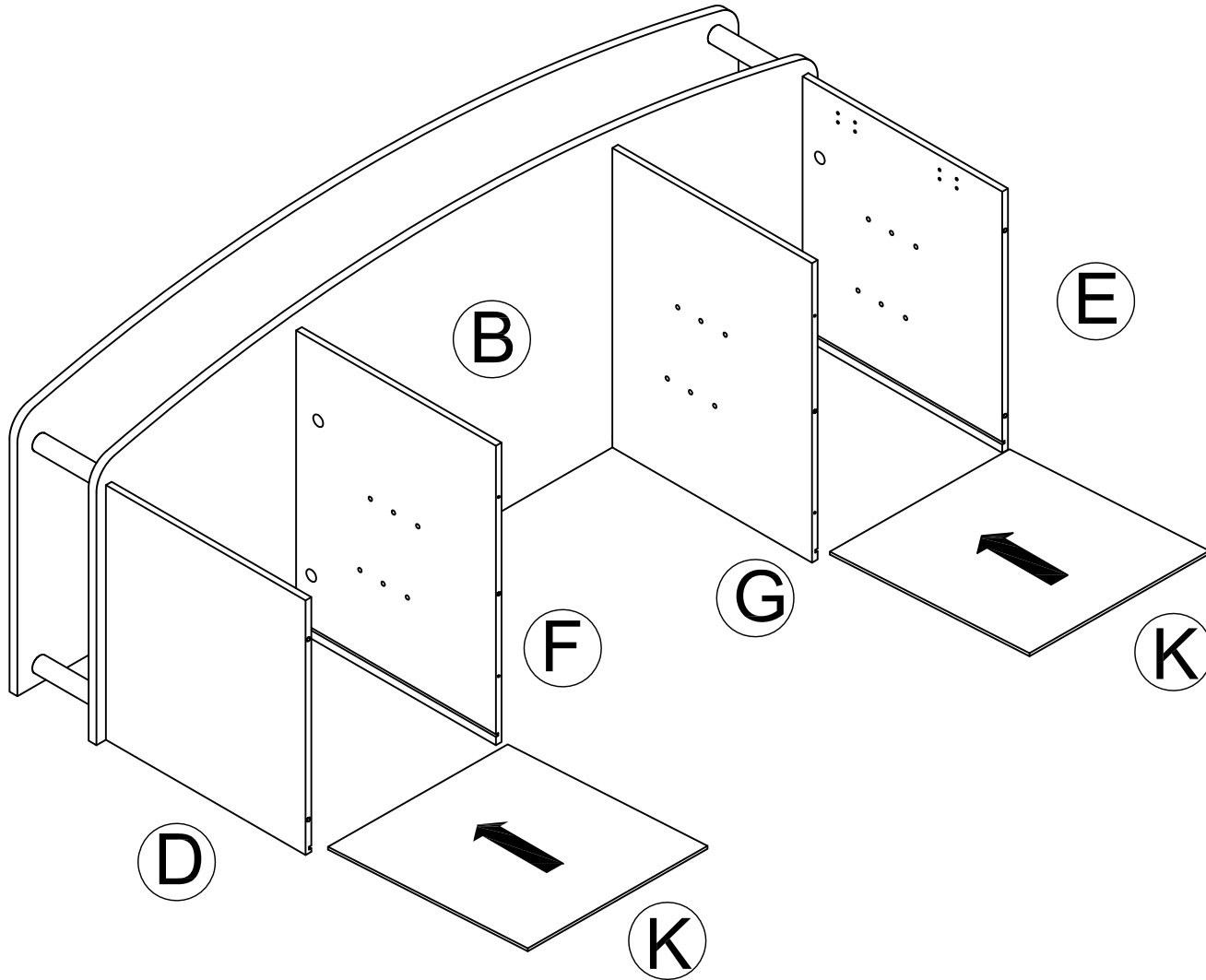

5

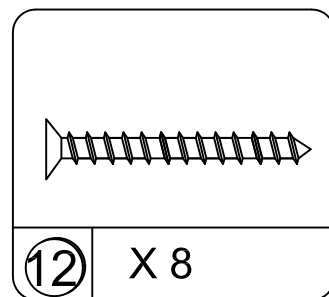
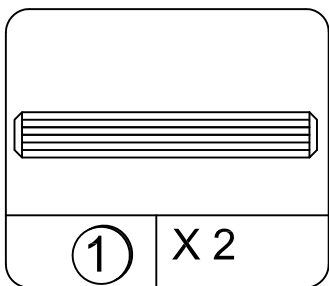
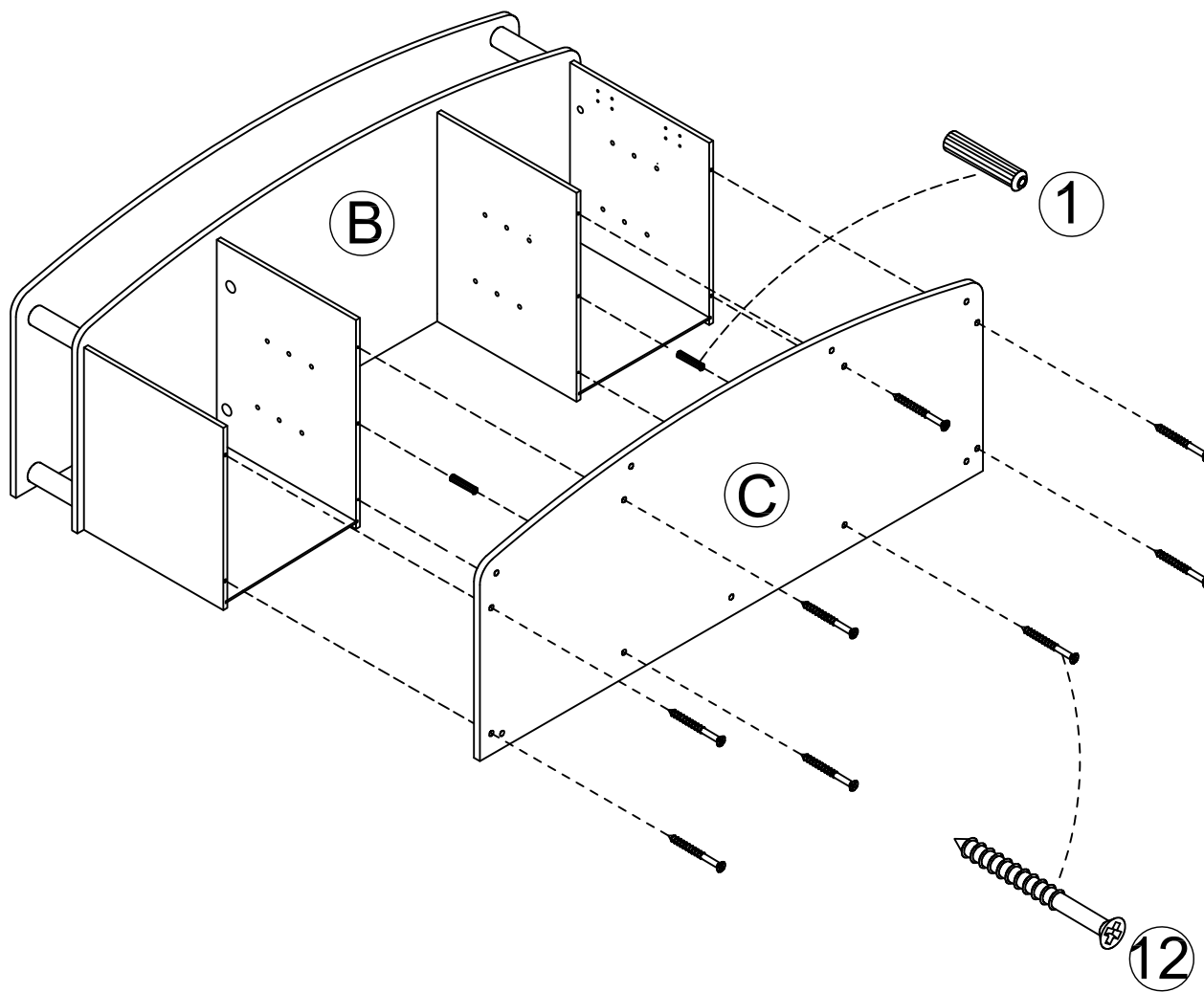

6

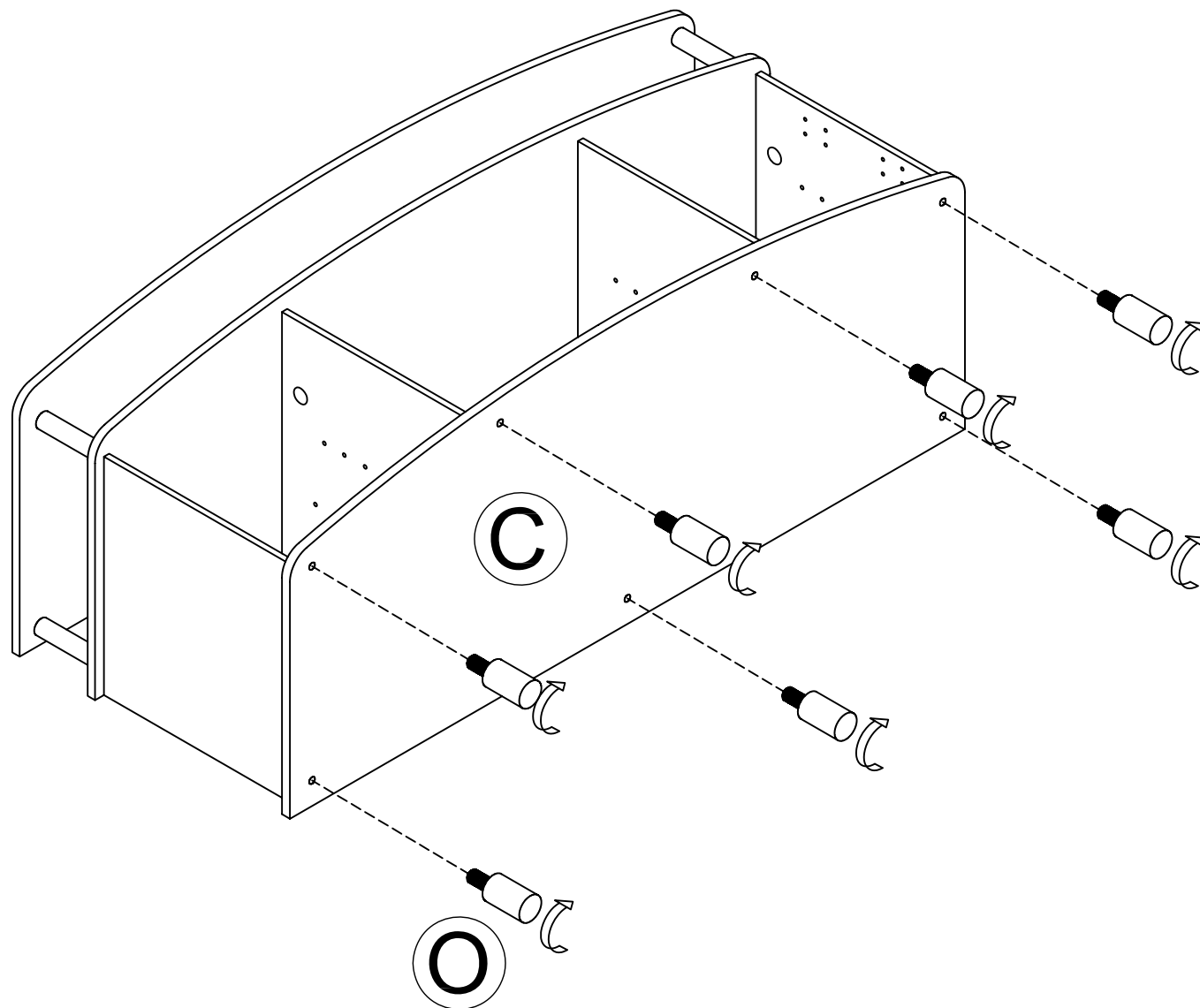

7

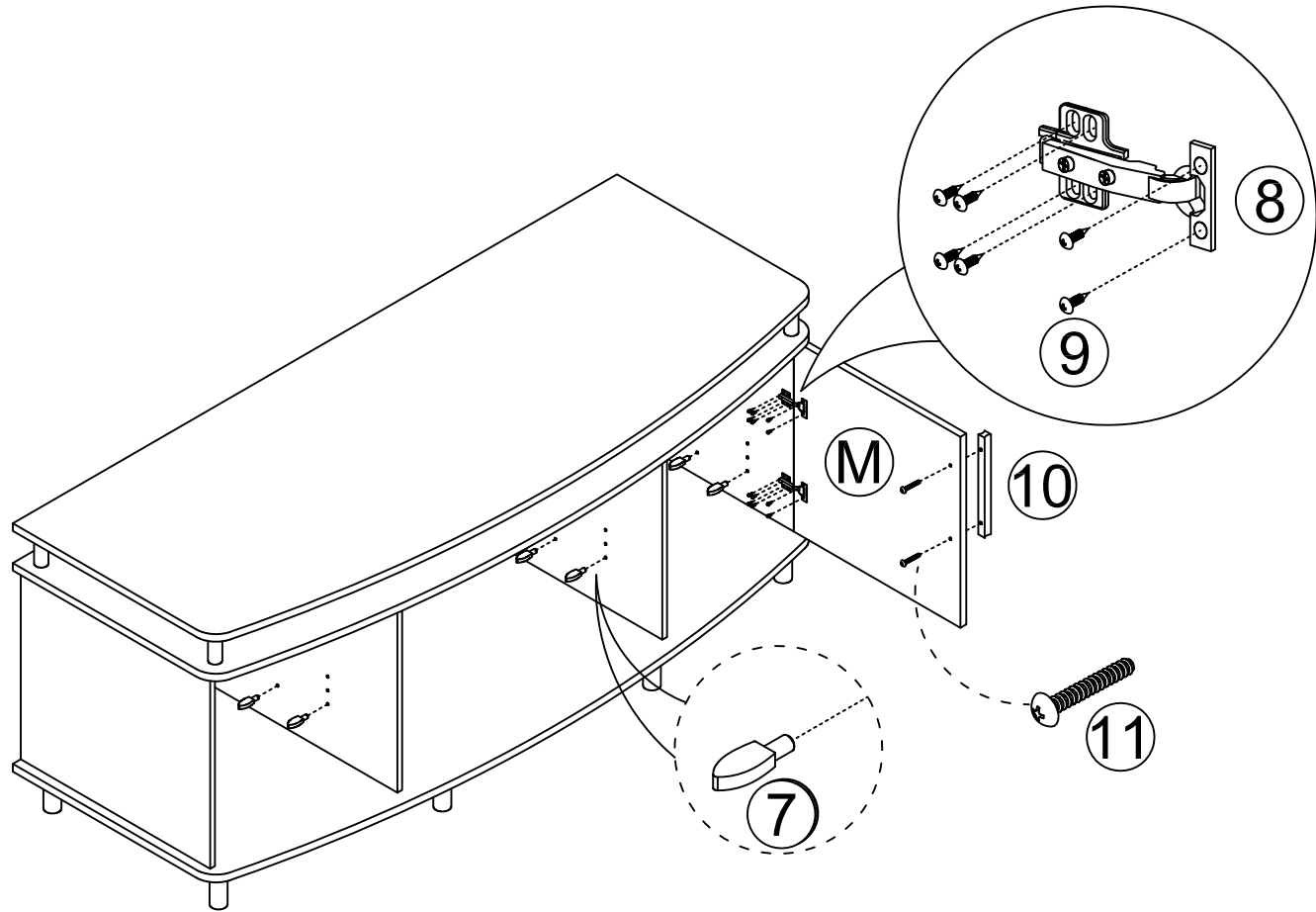
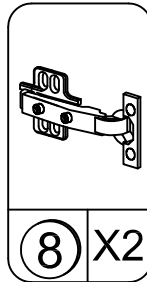
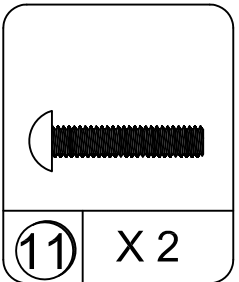
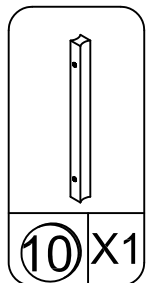
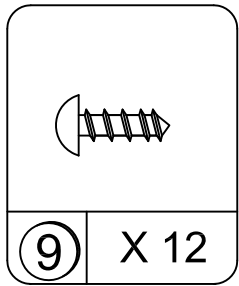
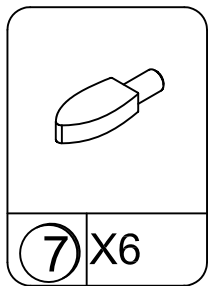

8

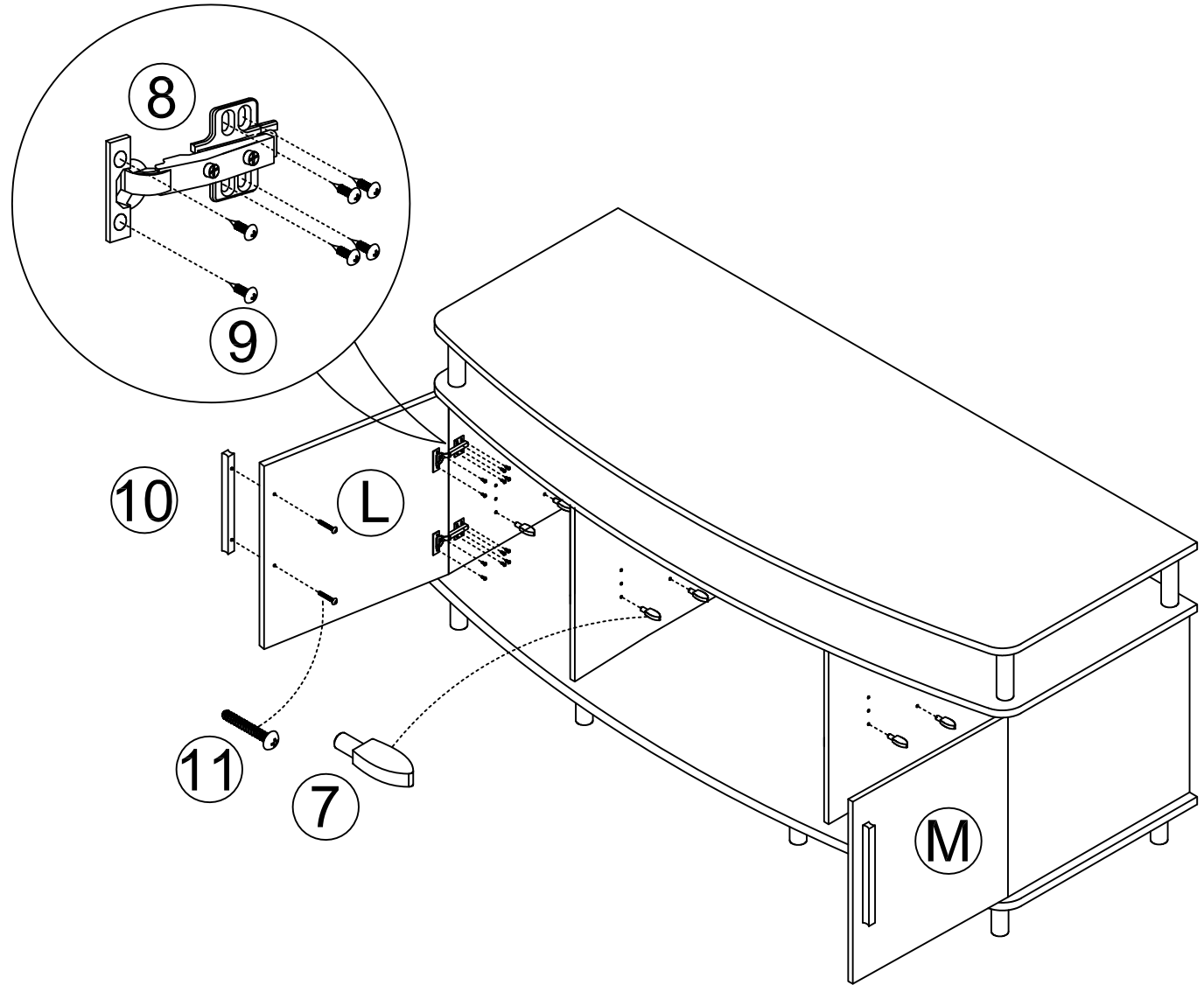
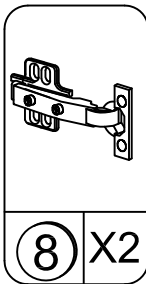
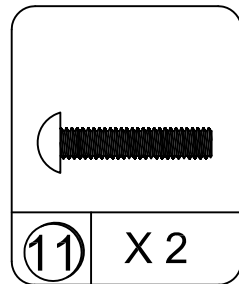
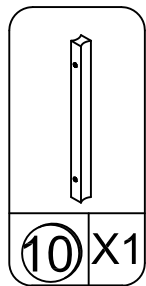
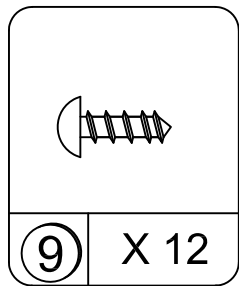
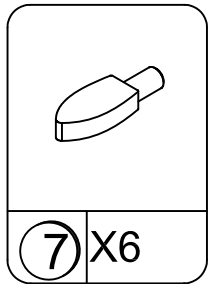

9

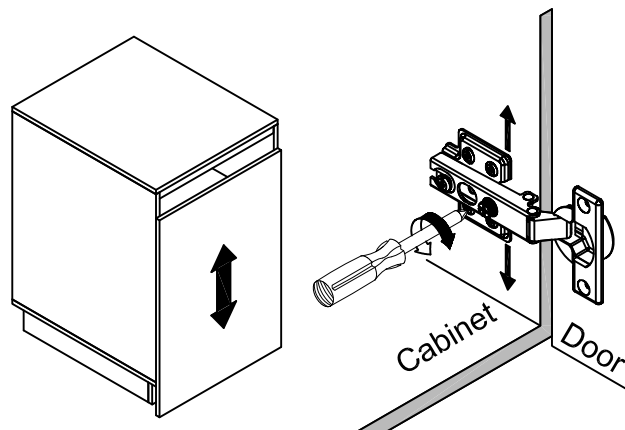
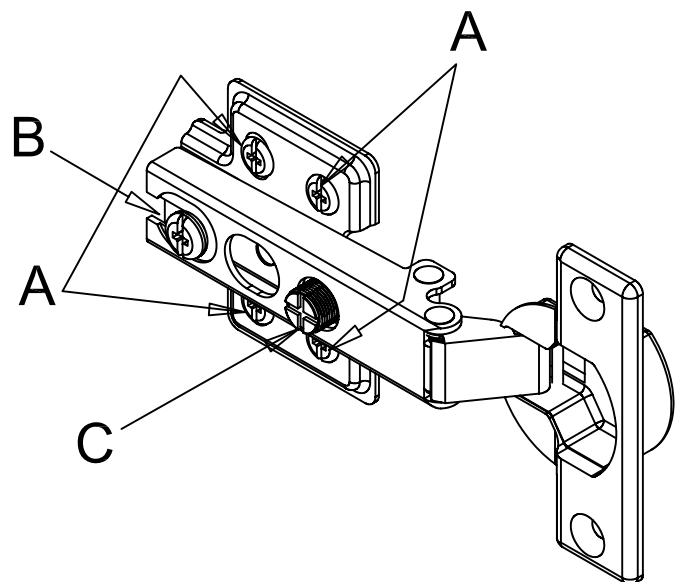

To adjust the vertical height.

Loosen the four screws "A" on both hinges. Two of them are usually in slotted holes which mean and you can adjust up or down by a few mm. Then tighten back up

Pour régler la hauteur verticale.

Desserrez les quatre vis "A" sur les deux charnières. Deux d'entre elles sont habituellement dans des fentes afin de vous permettre de les ajuster vers le haut ou le bas de quelques mm. Resserrez les vis après l'ajustement.

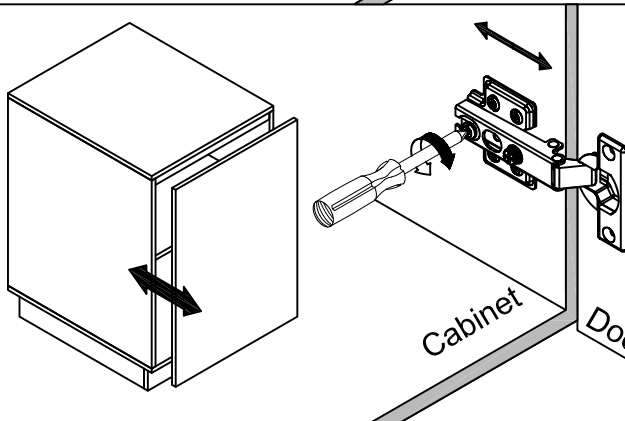

To adjust depth.

Loosen screw "B" and adjust door, if the door can not be adjusted, please loosen screw "C", then try again. Tighten screw "B" and "C".

Pour régler la profondeur.

Desserrez la vis "B" et ajustez la porte. Si la porte ne peut pas s'ajuster, desserrez la vis "C", puis essayez de nouveau. Serrez les vis "B" et "C".

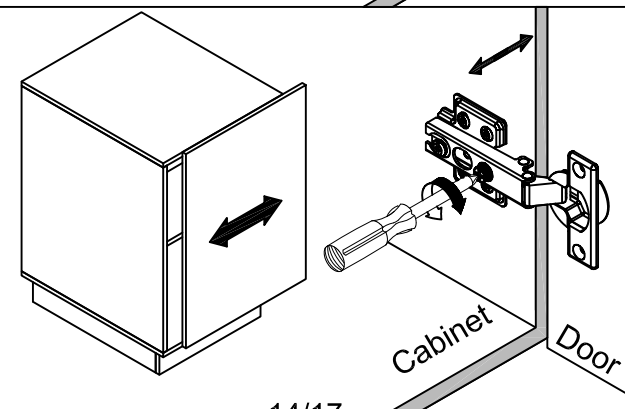

To adjust side ways.

Turning the screw "C" on BOTH hinges on each door.

Pour régler latéralement.

Tournez la vis "C" sur les DEUX charnières de chaque porte.

10

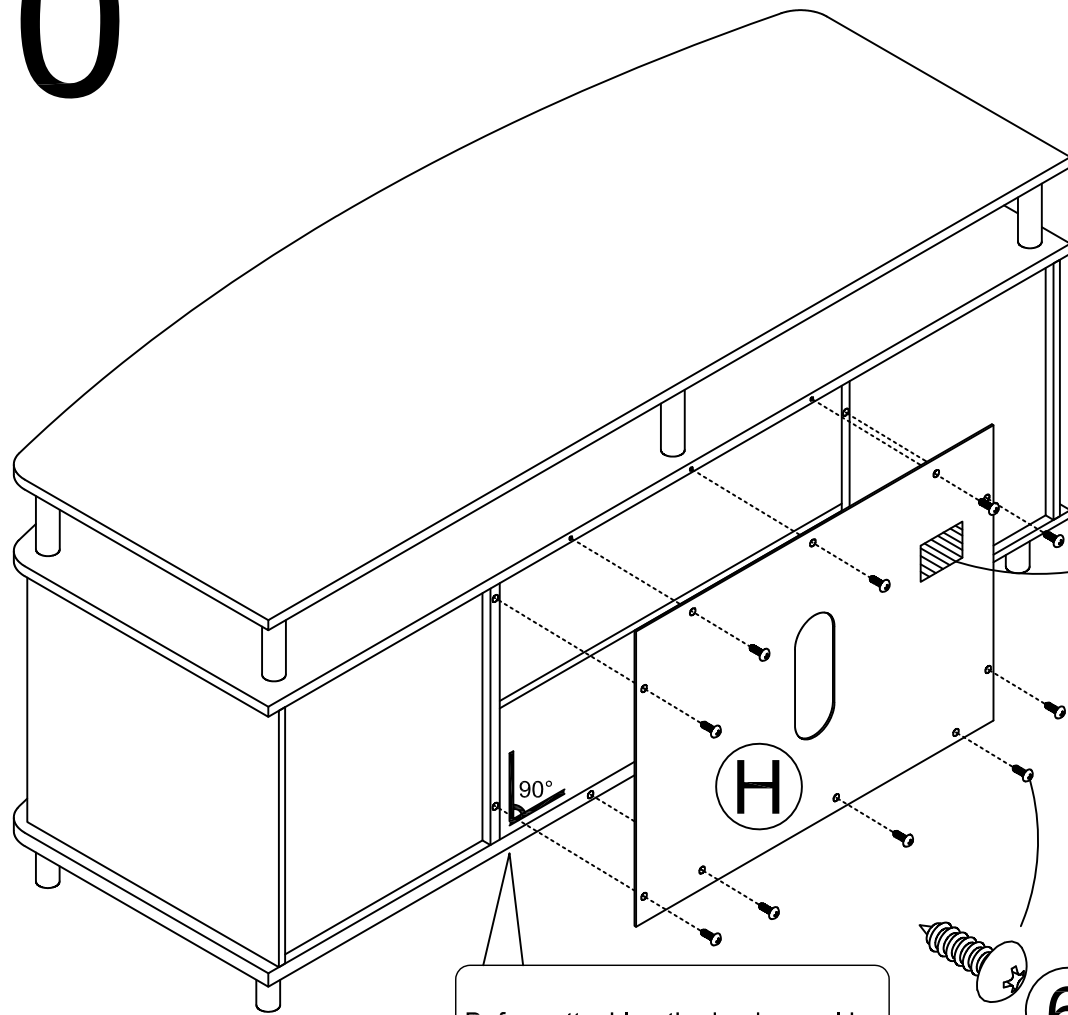

Before attaching the back panel be sure that the unit is at 90°.

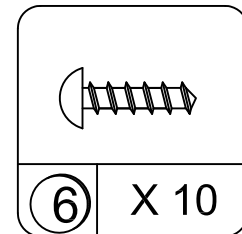
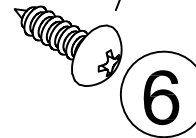

WARNING LABEL

Risk of death or serious injury. This surface must be placed against a fixed in place wall at least as tall as television.

ETIQUETA DE ADVERTENCIA

Riesgo de muerte o lesión. Esta unidad debe ser colocada frente a una pared y debe ser instalada por lo menos a la misma altura que una televisión.

11

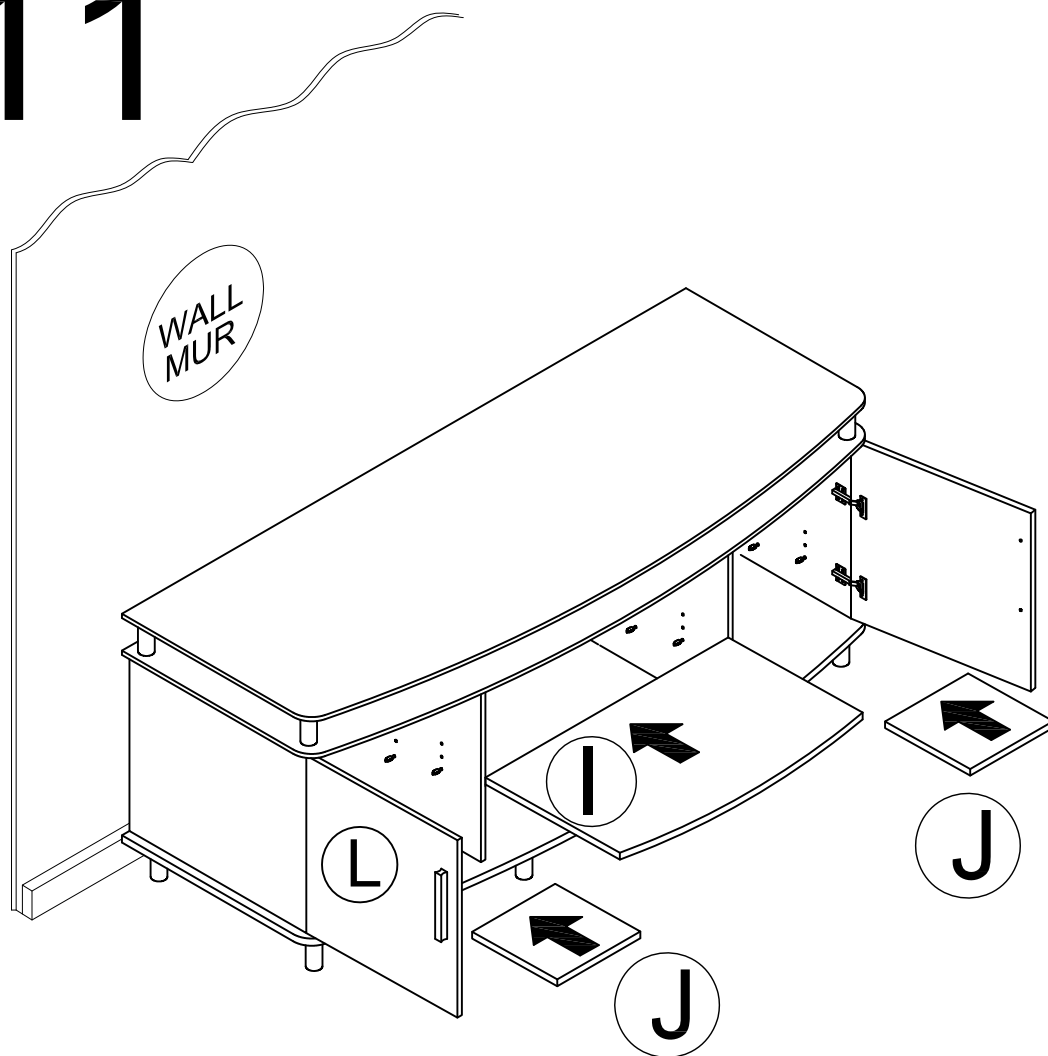

WARNING

Risk of death or serious injury.
This unit must be placed against
a fixed in place wall at least as
tall as television.

ADVERTENCIA

Riesgo de muerte o lesión. Esta
unidad debe ser colocada frente
a una pared y debe ser instalada
por lo menos a la misma
altura que una televisión.

WEIGHT LIMITS:
LÍMITES DE PESO:

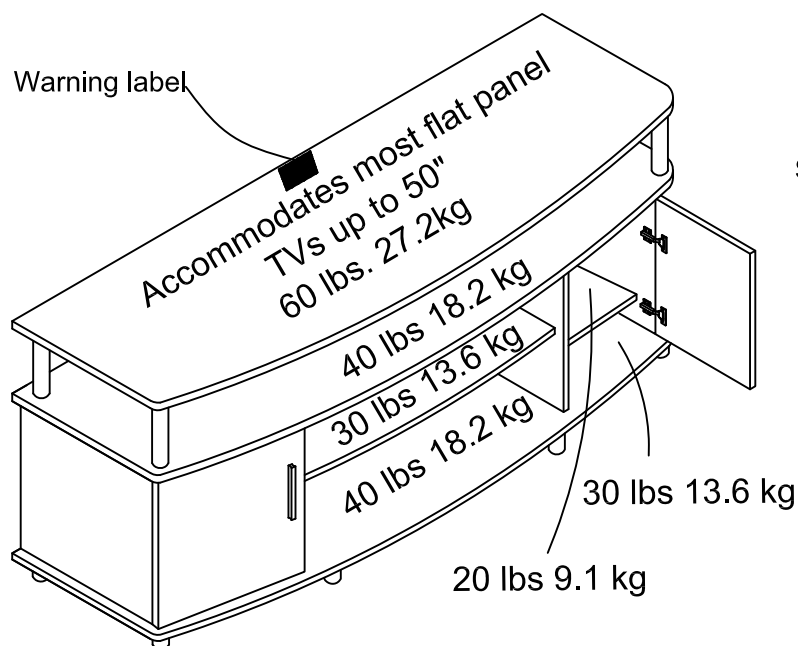

Enjoy Your Furniture
Disfrute de su mueble

This unit has been designed to support the maximum loads shown.

Exceeding these load limits could cause sagging, instability, product collapse, and/or serious injury.

Esta unidad se ha diseñado para apoyar las cargas máximas mostradas.

Exceder estos límites de carga podría causar ceder, inestabilidad, derrumbamiento del producto, y/o lesión seria.

▲ WARNING

Please make sure that all objects are removed before moving the assembled unit. The unit must be team lifted, not dragged or pushed. Failure to do so could cause instability, product collapse, and/or serious injury.

▲ ADVERTENCIA

Por favor mueva el mueble cuidadosamente con la ayuda de otra persona. levante y mueva el mueble a su lugar. no lo arrastre o empuje, de lo contrario puede haber inestabilidad en el mueble y este puede colapsar u ocasionar graves lesiones.