

# NOTES

---



---



---



---



---



---



---



---



---



---



---



---



---



---



---



---



---



---



---



---



---



---



ECO1800S

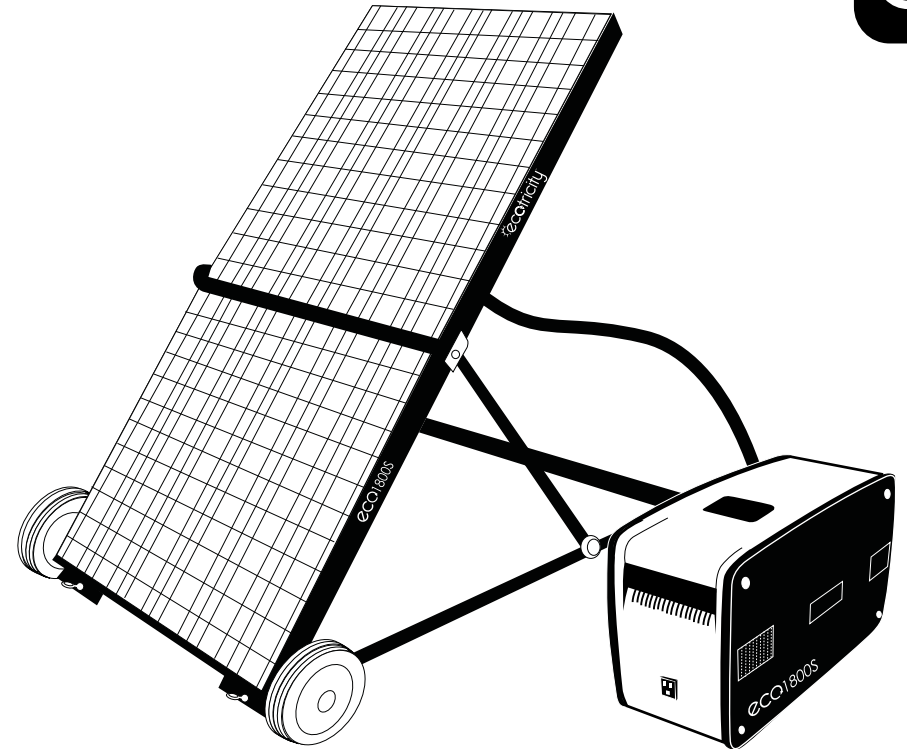

## UPG CONTACT INFORMATION

Universal Power Group  
 1720 Hayden Drive  
 Carrollton, TX 75006

P - 469.892.1122  
 TF - 866.892.1122  
 www.upgi.com

## Owner's Manual



## TABLE OF CONTENTS

EcoI800S Solar Power Generator Specifications	3 - 7
Instructions for EcoI800S Solar Panel Set-Up	7 - 12
EcoI800S Solar Generator Warnings	13 - 16
EcoI800S Solar Generator Features	17 - 18
EcoI800S Solar Generator Installation	19 - 20
Operating the EcoI800S Solar Generator	20 - 25
Troubleshooting	25 - 30
Warranty & Return Policy	31 - 33
Information About Your System	34

Please carefully read this owner's manual before using your EcoI800S Solar Power Generator. Failure to do so may cause injury or damage to the product.

ecoI800S

## ECO I800S SOLAR POWER GENERATOR GENERAL INFORMATION

The EcoI800S Solar Power Generator uses a 90 watt solar panel to “capture” the sun’s energy. The sun’s energy is then used to charge the batteries inside the EcoI800S Solar Generator which includes an 120 VAC inverter that can operate your AC devices. Your EcoI800S Solar Generator can charge the batteries through the ECOI800 Solar Panel, the 120 VAC line cord OR both at the same time.

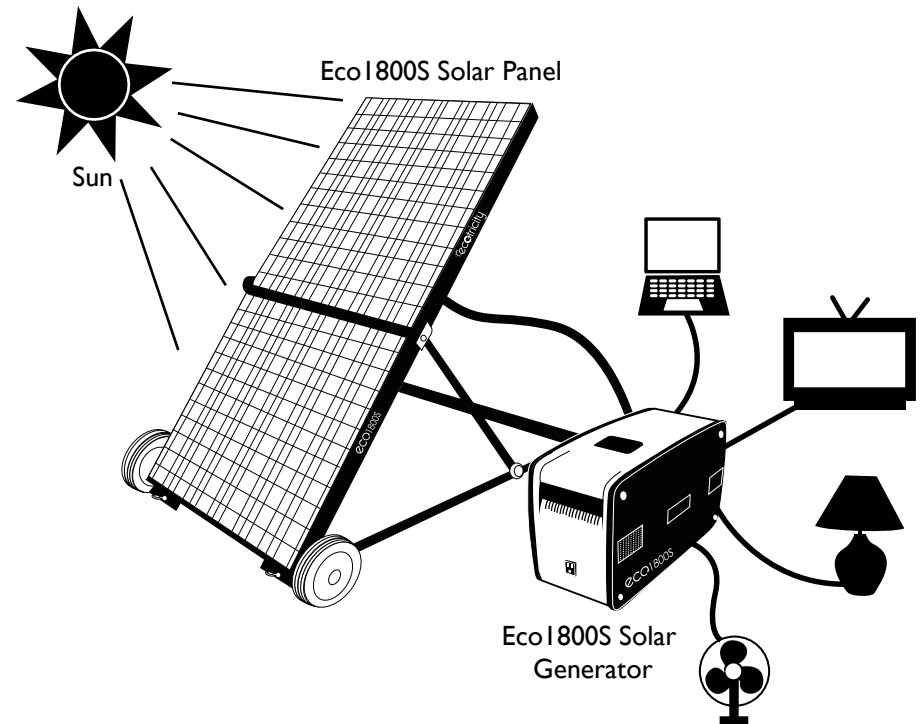

# ECO1800S SOLAR PANEL SPECIFICATIONS

DESCRIPTION	SPECIFICATION	MATERIAL	CONTENT	SAFETY CODE	UNIT OF MEASUREMENT	QUANTITY
Solar Trolley	620*540.40/45wp	Class A Mono	Mono Silicon + Glass	ROHS	PCE	2
Connecting Wire	Flat-form/3a/1.1m	Twin-Wire Inside A Cable	Copper Wire Core With Isolated Cover Cable	REACH	Meter	1.1
Wheel	Sr1303/152.4mm	Felloe:Rubber Inside Wheel:PVC	Rubber + PVC	ISA	PCE	2
Screw of Wheel	M10*53/Screw Step 38*12.5	Zincification Iron	99% Iron +1% Zinc	ISA	PCE	2
Screw Shim	∅ 24 (Inner ∅ 10) 1mm Thickness	Zincification Iron	99% Iron +1% Zinc	ROHS	PCE	2
Screw Shim	∅ 12 (Inner ∅ 6.4 Black PVC Thickness 1mm)	Rubber	Anti Fire Rubber	ROHS	PCE	6
Screw	M6*20 Black	Zincification Iron	99% Iron +1% Zinc	ISA	PCE	17
Screw	M6*35 Black	Zincification Iron	99% Iron +1% Zinc	ISA	PCE	2
Screw	M6*25 Black	Zincification Iron	99% Iron +1% Zinc	ISA	PCE	1
Screw Cap	M6 Black Antiskid	Zincification Iron	99% Iron +1% Zinc	ISA	PCE	20
Screw Cap	M6 Black	Zincification Iron	99% Iron +1% Zinc	ISA	PCE	2
Screw	M5*16 Black	Zincification Iron	99% Iron +1% Zinc	ISA	PCE	4
Screw Cap	M5 Antiskid	Zincification Iron	99% Iron +1% Zinc	ISA	PCE	4
Screw	M6*16 Round Head	Zincification Iron	99% Iron +1% Zinc	ISA	PCE	2
Plastic Screw Cap	Wabblers/ Wide 30mm/ Inner M6 Screw Thread	Plastic & Copper	Plastic + Copper	ROHS	PCE	3
Rivet	M4*14 Bake Black	Aluminium	85% Aluminium + 15% Iron	ISA	PCE	26
Loose Leaf	520*1.5 Inch Black	Stainless Steel	30% Iron + 70% Stainless Steel	ROHS	PCE	1
Shield Sleeve	Eva 350* ∅ 25 (Inner)	Eva	Eva	ISA	PCE	1
Shim Block	∅ 16 (5mm)	Rubber	Rubber	ROHS	PCE	3
Seton Rack Shield Angle	∅ 8*15	Rubber	Anti Fire Rubber	REACH	PCE	4
Bracket 1	75*25*3mm	Aluminium	Aluminium	ISA	PCE	2
Bracket 2	75*25*3mm L & R	Aluminium	100% Aluminium	ISA	PCE	2
Bracket 3	520*25*3mm	Aluminium	100% Aluminium	ISA	PCE	2
Bracket 4	390*25*3mm	Aluminium	100% Aluminium	ISA	PCE	2
Bracket 5	622* ∅ 25	Aluminium	100% Aluminium	ISA	PCE	1
Bracket 6	690*25*3mm L & R	Aluminium	100% Aluminium	ISA	PCE	2
Bracket 7	80*25*3mm	Aluminium	100% Aluminium	ISA	PCE	1
Bracket 8	82*25*3mm L & R	Aluminium	100% Aluminium	ISA	PCE	2
Bracket 9	360*10*4mm Black	Stainless Steel	100% Stainless Steel	ISA	PCE	2
Camp nail	80* ∅ 7	Cap : PVC	Pvc + Steel	ISA	PCE	4
Belt	1.6m	Sacking	Sailcloth + PVC	ISA	PCE	1
EPE	Packaging Case	EPE	EPE	ROHS	SET	1

# ECO I 800S SOLAR PANEL SPECIFICATIONS CONT.

**NOTE:** Specifications are subject to change without prior notice.

Monocrystalline silicon solar cells	
Power (Pm)	90 wp
Open Circuit Voltage (Voc)	22.40 V
Maximum Power Current	5.02 A
Maximum Circuit Voltage	18 V
Short Circuit Current (Isc)	5.4 A
Temperature Coefficients of Isc (%)	0.065 +/- 0.015%
Temperature Coefficients of Voc (%)	-2.23 +/- 0.1 mv
Temperature Coefficients of Pm (%)	-0.5 +/- 0.05
Temperature Coefficients of Im (%)	+0.1
Temperature Coefficients of Vm (%)	-0.38
Temperature Range	-40 +85°C
Tolerance Wattage (e.g. +/-5%)	+/-5%
Surface Maximum Burden Weight	.28 lbs/sq. inch (30m/s, 200kg/sq.m)
Allowable Hail Load	Steel ball dropped from 1m height
Junction Box Type	PPO, Black
Length of Cable (Ft.)	50 foot
Cell Efficiency (%)	17%
Output Tolerance (%)	+/-5%
Frame Material	Anodized Aluminum Alloy
Standard Test Conditions	AM1.5 1000mW/C 25° C
FF (%)	75%
Packing	Carton
Dimensions	42.75" x 24.5" in. (1086mm x 622.3mm)
Weight	33 lbs (15 kg)

# ECO I 800S SOLAR GENERATOR SPECIFICATIONS

**NOTE:** Specifications are subject to change without prior notice.

## PHYSICAL SPECIFICATIONS

Dimensions	19.25" x 8.25" x 11.25" in. (489 x 210 x 286 mm)
Weight	60 lbs (27.2 kg)
Operating Temperature	32 - 86° F (0 - 30°C)
Storage Temperature	32 - 104°F (0 - 40°C)

## REGULATORY APPROVALS

Safety	1. ETL Certified to: <ul style="list-style-type: none"> <li>•CSA 107.3 - 05</li> <li>•UL 458 Ed. 5, UL 1741 Ed. 1 and UL 1778 Ed.4</li> </ul>
	2. FCC Class B

## ELECTRICAL SPECIFICATIONS

Continuous output power	1440W
Peak AC output power	1800W
Surge capacity	2600W
Output voltage (nominal)	120VAC
Output frequency	60Hz
Output wave form	Modified sine wave
Transfer switch	15A max/<80 milliseconds

## ELECTRICAL SPECIFICATIONS

Surge suppression	Yes
Inverter on (no-load current draw)	<0.6 A (battery drain)
Charging time	18 hour from 120VAC

## 12VDC SPECIFICATIONS

12VDC power port input/output voltage	12VDC (nominal), 14.7VDC (max)
---------------------------------------	-----------------------------------

# ECO1800S SOLAR GENERATOR SPECIFICATIONS CONT.

12VDC power port input/output current	12A (max)
Internal battery type	Sealed lead-acid, V.R.L.A., deep cycle
Internal battery capacity	60 amp-hours (3 x 20 amp-hour batteries)
Internal battery voltage	12VDC (nominal)
Low battery alarm	11.0VDC (nominal)
Low battery shutdown	10.5VDC (nominal)
Internal charger charging current	5 A (max)

## PV CHARGE CONTROLLER (PVCC) SPECIFICATIONS

DC input voltage	12VDC (nominal), 25VDC (max)
DC input current	8A (max) - this typically corresponds to a 120-watt solar panel

# INSTRUCTIONS FOR ECO1800S SOLAR PANEL SETUP

## SOLAR PANEL SITE SELECTION

Selecting the best site for the Eco1800S Solar Panel is very important for the charging of your batteries. Select a site that has an unobstructed view of the south.

Please see diagram on page 8.

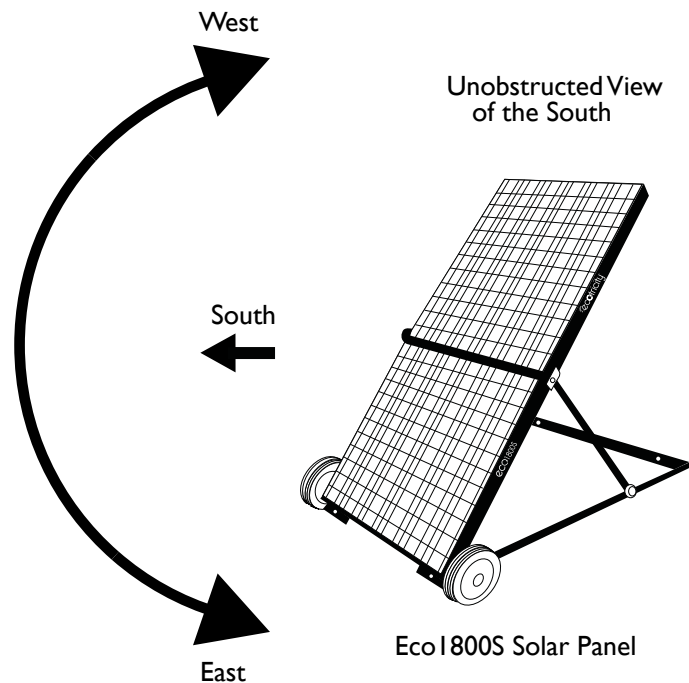

## DIAGRAM OF ECO1800S SOLAR POWER GENERATOR

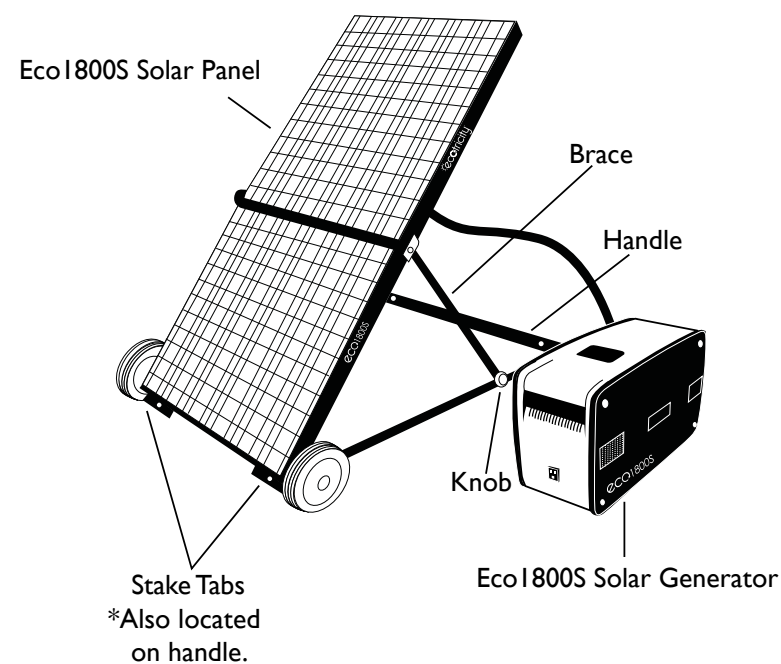

# INSTRUCTIONS FOR ECO1800S SOLAR PANEL SETUP CONT.

Please follow these instructions thoroughly for best possible results. There is also an instruction label located on the back of the Eco1800S Solar Panel with a quick guide to set up instructions. Please refer to "PV Solar Input Installation" on pages 21-23.

- 1 Cover the Eco1800S Solar Panel with an opaque sheet such as a sheet or blanket to reduce it's output to zero volts.

- 2 Lay your Eco1800S Solar Panel flat, handle down.

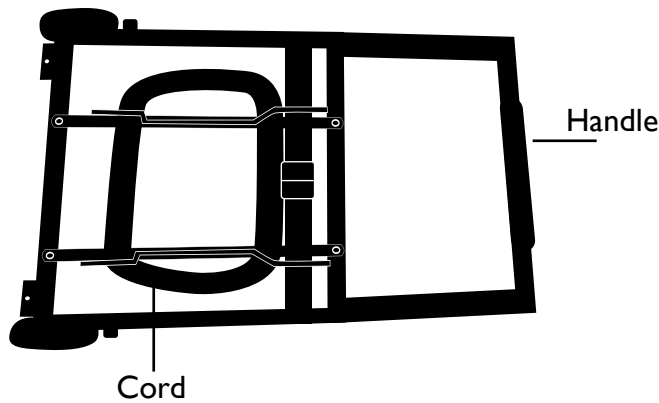

- 3 Unwrap cord. DO NOT connect the cord to the Eco1800S Solar Generator at this time.

- 4 Remove 2 inch strap (belt) securing the folded solar panel.

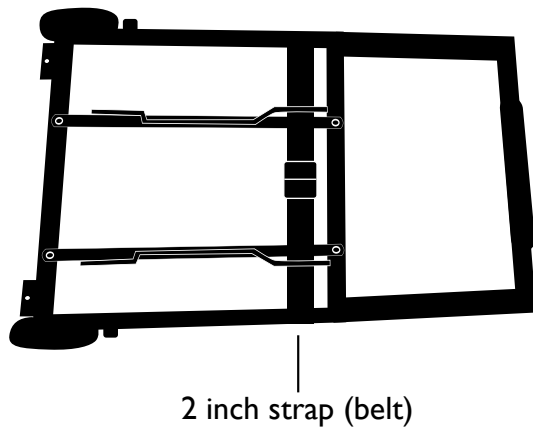

- 5 Remove knobs on both sides of frame and set aside.

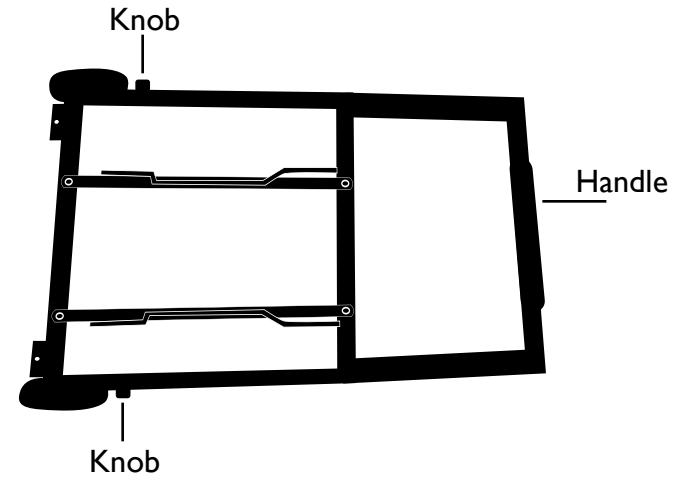

- 6 Lift both solar panels from underneath. Fold the brace down and place bolts in the appropriate holes in the side of the solar panel frame to make solar panel perpendicular to the sun.

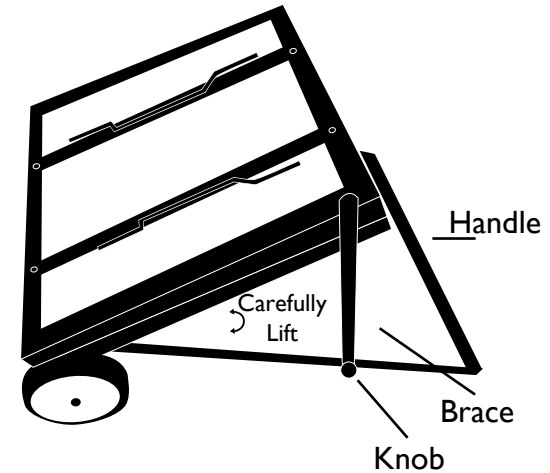

- 7 Carefully turn knobs clockwise onto the bolts mentioned in step 5.

# INSTRUCTIONS FOR ECO I800S SOLAR PANEL SETUP CONT.

- 8** Carefully unfold the top solar panel.

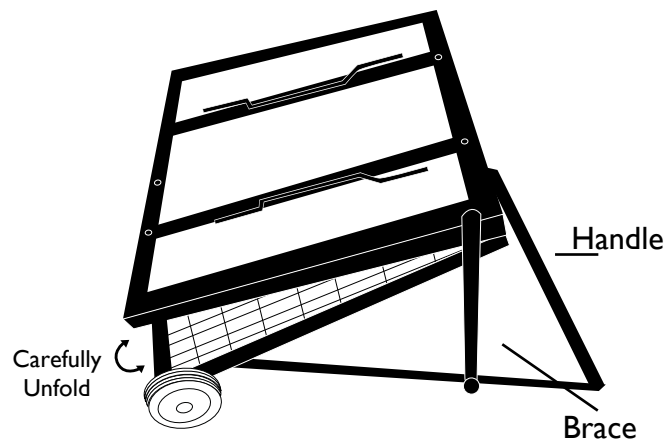

- 9** Carefully slide lock which connects the two solar panels and lock into place by turning knob clockwise.

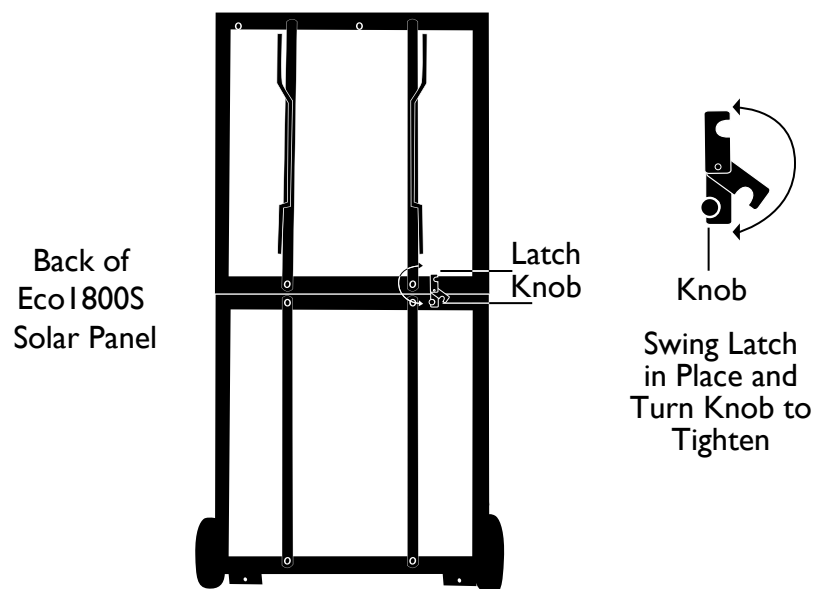

- 10** If conditions require, carefully secure your solar panel using the four (4) ground stakes included with your Eco I800S Solar Power Generator in the proper front and back holes.

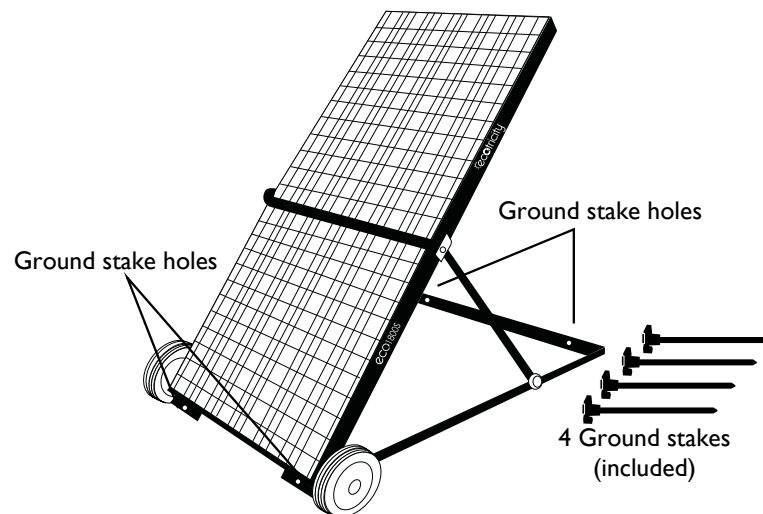

- 11** Connect the Eco I800S Solar Panel to the Eco I800S Solar Generator using the 50 foot cord included with your Eco I800S Solar Power Generator.

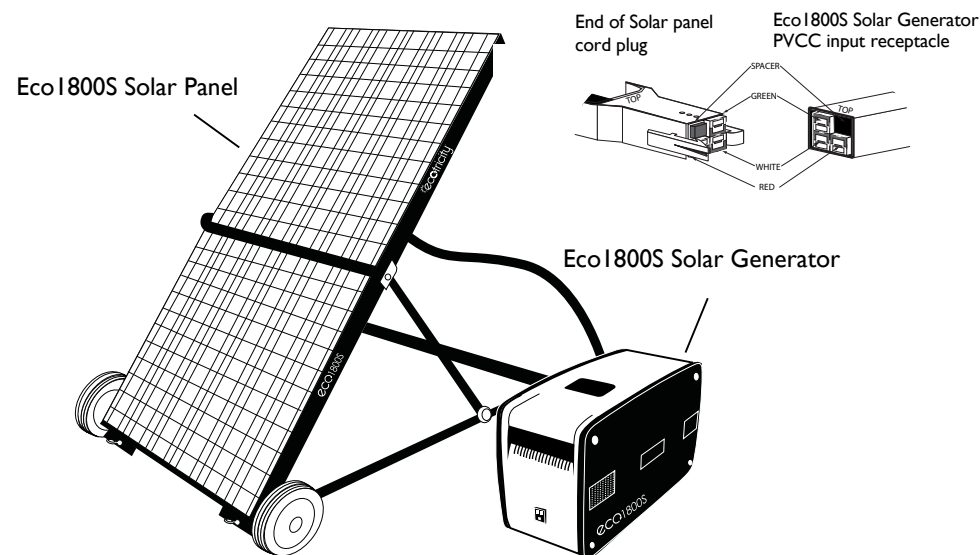

- 12** Cover the Eco I800S Solar Panel with an opaque sheet such as a sheet or blanket to reduce it's output to zero volts. Then follow instructions 11-2 to disassemble the Eco I800S Solar Panel.

# ECO I800S SOLAR POWER GENERATOR WARNINGS

Before using your Eco I800S Solar Power Generator, please READ ALL instructions and cautionary markings on or provided with the Eco I800S Solar Power Generator.

## WARNING

### STATEMENT OF HAZARD

Contains statements of avoidance or strict compliance. Failure to follow these instructions may result in serious injury or death.

## DANGER

### ELECTRICAL SHOCK, EXPLOSION OR ARC FLASH HAZARD

- Do not expose the Eco I800S Solar Generator to rain, snow, spray or bilge water.
- Do not operate Eco I800S Solar Generator if it has been dropped, damaged, has cracks or openings in the enclosure. Do not use the Eco I800 Solar Panel if the panel has cracks or will not close or otherwise damaged in any other way.
- Do not disassemble Eco I800S Solar Generator. There are no user-serviceable parts inside.
- If Eco I800S Solar Panel is broken, please DO NOT touch. The Solar cells could contain hazardous materials.

## WARNING

### FIRE AND/OR CHEMICAL BURN HAZARD

- Do not cover or obstruct the air intake vent openings.
- Do not use the Eco I800S Solar Generator if the unit is visibly leaking liquid. It is possible that the internal battery has been damaged and battery acid has spilled.

# FCC INFORMATION TO THE USER

This equipment has been tested and found to comply with the limits for a Class B digital device, pursuant to part 15 of the FCC Rules. These limits are designed to provide reasonable protection against harmful interference in a residential installation. This equipment generates, uses and can radiate radio frequency energy and if not installed and used in accordance with the instructions, may cause harmful interference to radio communications. However, there is no guarantee that interference will not occur in a particular installation. If this equipment does cause harmful interference to radio or television reception, which can be determined by turning the equipment off and on, the user is encouraged to try to correct the interference by one or more of the following measures:

- Reorient or relocate the receiving antenna.
- Increase the separation between equipment and receiver.
- Connect the equipment into an outlet on a circuit different from that to which the receiver is connected.
- Consult the dealer and/or experienced radio/TV technician for help.

## CAUTION

Unauthorized changes or modifications to the equipment could void the manufacturer's warranty.

# GUIDELINES FOR USE

The continuous wattage of this product is limited to 1440 watts total when supplying backup power from its batteries. This limit applies to the total of all items plugged into the product.

This output wattage is not sufficient to run products designed to produce large amounts of heat such as space heaters.

# PRECAUTIONS FOR USING RECHARGEABLE APPLIANCES

## CAUTION

### EQUIPMENT DAMAGE

When the Eco I800S Solar Generator is supplying backup power from its batteries, its output is a modified sine wave, which is different from pure sine wave utility-supplied electricity. Certain types of load equipment may be damaged.

Most rechargeable battery-operated equipment uses a separate charger or transformer that is plugged into an AC receptacle and produces a low voltage charging output. Some chargers for rechargeable batteries can be damaged if connected to the Eco I800S Solar Generator.

Do not use the following with the Eco I800S Solar Generator:

- Small battery-operated appliances like flashlights, razors and night lights that can be plugged into an AC receptacle to recharge.
- Some chargers for battery packs used in hand power tools. These chargers display a warning label stating that dangerous voltages are present at the battery terminals.

### PRODUCTS WITH POTENTIAL PROBLEMS

Some products, including the types listed below, may be damaged if they are connected to the Eco I800S Solar Generator:

Speed controllers found in some fans, power tools, kitchen appliances and other loads may be damaged.

Metal halide arc (MHI) lights can be damaged.

## REGULATORY

The Eco I800S Solar Generator is Certified to appropriate US and Canadian standards.

The Eco I800S Solar Generator is intended to be used for providing backup power for office equipment and household appliances. It is not intended for other applications as it may not comply with the additional safety code requirements needed for those other applications. Additionally, the Eco I800S Solar Generator is not classified as an Uninterruptible Power Supply (UPS) device that can provide uninterrupted power to personal computers and other electrical devices.

## WARNING

### LIMITATIONS ON USE

- Do not use in connection with life support systems or other medical equipment or devices.
- Do not use in ambulances or other life-saving emergency vehicles.

You can find more information about Universal Power Group, Inc. as well as its products and services at [www.upgi.com](http://www.upgi.com).

# ECO1800S SOLAR GENERATOR FEATURES

## FRONT AND AC OUTPUT PANELS

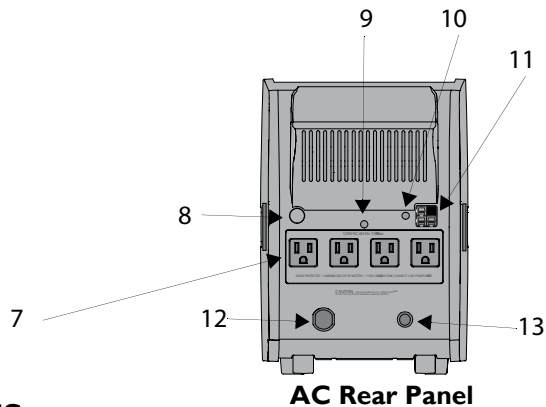
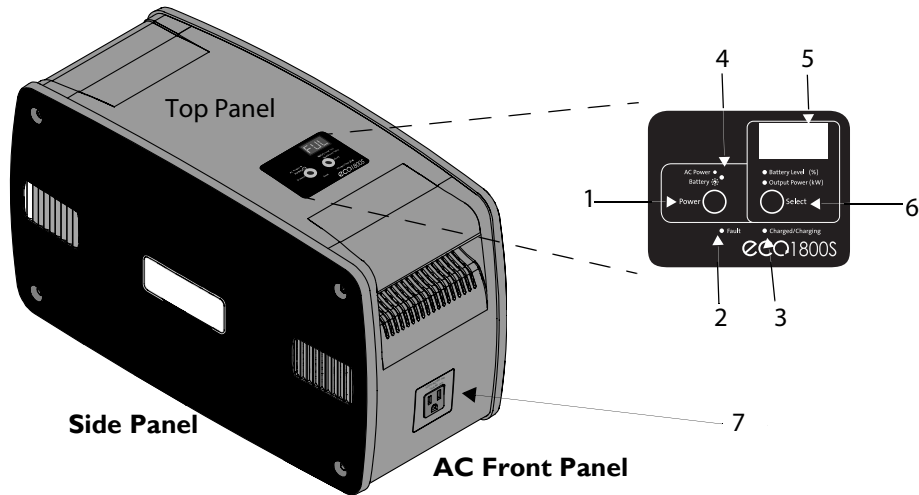

## FEATURES

ITEM	DESCRIPTION
1	<p><b>Power Button</b> turns Eco1800S Solar Generator on and off when utility power is not available.</p> <p>Pressing and holding the power button for at least half a second turns the unit on or off when utility power is not present.</p> <p>When utility power is available, the power button cannot be used to remove power from the 5 AC outlets.</p>

## FEATURES

ITEM	DESCRIPTION
2	<b>Fault LED</b> illuminates red when Eco1800S Solar Generator has an operation fault.
3	<b>Charged/Charging LED</b> (green) illuminates when Eco1800S Solar Generator is fully charged and flashes while Eco1800S Solar Generator is recharging.
4	<b>AC Power/Battery LED</b> illuminates green when utility power is available and flashes amber when Eco1800S Solar Generator is providing backup power using its internal battery.
5	<b>LED Screen</b> indicates charging status, power draw from the Eco1800S Solar Generator (W) when providing backup power, or battery capacity (%). The screen also shows error codes to aid troubleshooting.
6	<b>Select Button</b> displays Eco1800S Solar Generator battery level (%) or output power.
7	<b>Five 120V AC Outlets</b> (One in the front, four in the rear) for powering office equipment and household appliances that draw a maximum total of 1800 watts (1440 watt continuous). All outlets are surge protected and backed up by the Eco1800 Solar Generator internal battery. See WARNING on next page.
8	<b>12V DC Power Port</b> provides DC power to typical automotive accessories up to a maximum current of 12A.
9	<b>Blue LED</b> illuminates when AC power is available at the rear AC outlets.
10	<b>PV Solar Charging Status LED</b> flashes when charging, steady when the internal battery is fully charged or in a float mode, and off when solar energy is too low to charge the internal battery.
11	<b>PV Solar Panel Charge Controller (PVCC) Input Receptacle</b> has a built in charge controller and accepts up to a maximum of 8A from nominal 12VDC solar panel (maximum of 25 VDC).
12	<b>AC Power Cord.</b>
13	<b>15A Supplementary Protector Reset Button</b> resets the supplementary protector after a trip. The supplementary protector protects the Eco1800S Solar Generator's AC outlets and connected appliances from overload conditions.

## WARNING

### SHOCK HAZARD

If the AC power cord's input plug is connected to an AC source and utility power is present, all five AC outlets will be energized. The power button will not turn these AC outlets off.

## INSTALLATION

- The Eco I800S Solar Generator should be used or stored in a clean, indoor area and should be used in an indoor enclosure away from direct sunlight, heat, moisture or conductive contaminants.
- Charge battery immediately upon purchasing this product.
- To ensure optimum battery run time and life expectancy, plug Eco I800S Solar Generator into utility AC power for 72-hour initial charge.
- New lead-acid batteries reach their peak performance after being fully charged, fully discharged then fully recharged three to five cycles.
- This product contains sealed lead-acid batteries that perform best and last longest when maintained at 100% state-of-charge (SOC).
- Recharge before storage and also before use. Ensure the Eco I800S Solar Generator is turned OFF before storage. When in storage, recharge every three months.
- A complete charge may take up to 18 hours when recharging from a 120VAC wall outlet.

## CAUTION

### RISK OF EQUIPMENT DAMAGE

- Do not plug surge protectors or power strips into the unit's 120VAC outlets.
- Do not connect an AC power source to the 120VAC outlets.
- Do not connect the unit's AC power cord to its 120VAC outlets.

**IMPORTANT:** During installation, when placing the unit, allow a minimum of three inches of space around the unit for optimal ventilation.

## ECO I800S SOLAR GENERATOR INSTALLATION

1. Plug the power cord directly into a wall outlet (not into a surge protector or power strip).
2. Turn on the unit by pressing the Power button for at least half a second. The green AC Power LED confirms that the Eco I800S Solar Generator is on and ready to provide backup power. When the battery needs recharging, the LED screen flashes "CHG" 10 times, then the battery capacity (%) once. This pattern of flashing continues until the battery capacity reaches 100% and "FUL" appears on the screen.
3. Connect your electronic devices or small household appliances to the five AC outlets of the Eco I800S Solar Generator.

## BACKUP POWER FEATURE

The unit's five 120VAC outlets are permanently backed up by the internal battery when utility power is not available. To activate the AC outlets for backup operation, turn on the unit using the Power button. During a power outage or other utility problem (such as brownouts and over-voltages), Eco I800S Solar Power Generator will keep running the connected products for hours, depending on the power draw of your application (see "Run Time on Typical Products" and "Run Time for Combinations of Products"). When utility power is restored, the unit automatically recharges its internal battery.

**IMPORTANT:** When connected to utility power, the unit automatically provides AC power from its internal battery when the utility voltage falls below 105 VAC.

## EXTEND BACKUP POWER FEATURE

### RECHARGING FROM RENEWABLE ENERGY - PV SOLAR INPUT

The Eco I800S Solar Generator includes a special PV solar input receptacle to accept power from a 12 volt (nominal) PhotoVoltaic (PV) solar panel. When AC utility power is not available, PV Solar panel can provide a silent environmentally friendly internal battery recharge.

**NOTE:** The Eco I800S Solar Generator must remain in a cool, dry location while a suitable solar panel can be located outdoors in the sun.

# EXTEND BACKUP POWER FEATURE CONT.

## RECHARGING FROM RENEWABLE ENERGY - PV SOLAR INPUT

The Eco1800S Solar Generator input receptacle includes a built in 8-amp maximum photovoltaic charge controller (PVCC) to ensure the internal battery reaches a full charge without risk of overcharge. The PVCC 8-amp limit is capable of controlling solar panels with maximum current less than 8 amps.

PV Solar recharge time is dependent on the amount of PV Solar energy available from the panel, battery initial state-of-charge, and simultaneous 12V load on battery system (i.e., inverter ON, 12VDC accessory loads). PV Solar panel output power varies widely depending on intensity of sun (weather), angle of panel towards sun (perpendicular is best) and other factors. Under ideal solar harvest conditions and no load on battery, a typical 120W panel can recharge in twelve “sun hours<sup>1</sup>.” Even under less than ideal conditions, significant supplementary solar energy input will extend PowerSource 1800 Solar’s runtime.

1. Number of “sun hours” per day will vary by location and weather conditions. For example, sun hours per day in Seattle is “3”, which is low while in Las Vegas it is “7”, which is high.

The PVCC with it’s dedicated status LED operate independently from the Eco1800S Solar Generator’s built-in AC charger and its top panel display. The PVCC and the AC charger may be operated simultaneously for faster recharge. The PVCC includes a current blocking feature to prevent battery discharge at night due to a connected solar panel (reverse leakage). The Eco1800S Solar Generator may be operated in backup (inverter) mode while the PVCC/Solar panel is charging.

## PV SOLAR INPUT INSTALLATION

The PV Solar input “receptacle” accommodates connection of two poles plus ground from a portable solar panel fitted with cable and the matching Anderson Power Products # 1460G1-3 pole modular connector “plug” with color coded housings and contacts. Connections’ polarity and physical orientation must match the following exactly or equipment damage will result.

**IMPORTANT:** The type of damage described above is not covered by warranty.

Green housing contact	PV panel chassis ground
White housing contact	PV -/Negative
Red housing contact	PV +/Positive 12VDC nominal, maximum 25VDC

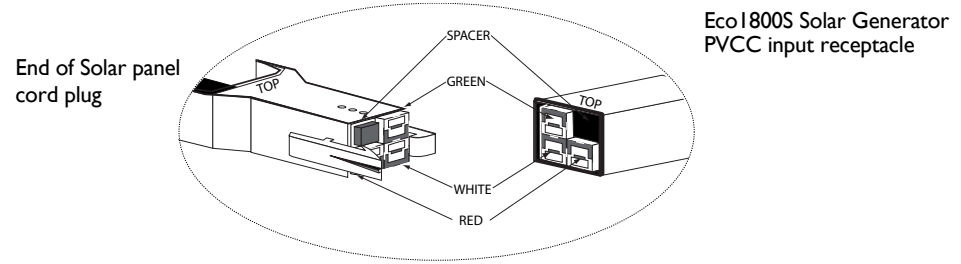

### TO CONNECT:

1. Cover the solar panel with an opaque sheet such as a blanket to reduce it’s output to zero volts.
2. Grasp the solar panel cord plug, align the color matched inserts and press into the receptacle on the rear panel of the Eco1800S Solar Generator until the retaining tabs click into place.

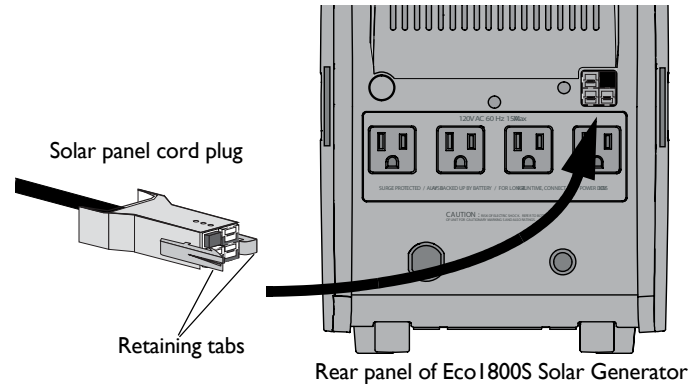

3. Uncover the solar panel and face it toward the sun.

**NOTE:** The solar panel cord plug and the PVCC input receptacle on the unit connect only one way, so do not force the plug into the receptacle if you rotate the plug some other way than indicated above.

### TO DISCONNECT

1. Cover the solar panel with an opaque sheet to reduce it’s output to zero volts.
2. Grasp the solar panel cord plug by squeezing the side retaining tabs to release and pull plug out of receptacle.

**IMPORTANT:** The Eco1800S Solar Generator's PVCC will be damaged if connected to a "24V" solar panel, or any source that exceeds 25 VDC.

**NOTE:** A "12V" solar panel, under Open Circuit conditions and sunlight exposure can typically produce 23 volts. Refer to the specifications label on the solar panel before connecting. Do not connect the PVCC to a PV source capable of delivering more than 8 amps.

Ensure that the PV solar panel is exposed to sufficient direct sunlight and is producing sufficient power throughout the day for optimum energy harvest and battery charging.

**NOTE:** It is recommended to always charge the internal battery to a 100% state-of-charge, as shown by a steady green PVCC status LED, and avoid deficit (or partial) charging. Deficit charging reduces a battery's useful service life.

## AC POWER CAPABILITIES

Power Consumption of Loads	Normal Operation with Utility Power	Ability to Provide Backup Power
Up to 1800W	Yes	Yes (up to 1440 W continuous backup power mode)
Over 1800W	No. Supplementary protector may trip.	No. Overload shutdown.

To check the total power consumption of the products plugged into Eco1800S Solar Generator during backup power mode, press the Select button and view the Output Power (W) on the screen.

To test the Eco1800S Solar Generator backup power capabilities after installing the unit, unplug the AC power cord to simulate a power outage. Ensure the products connected to the Eco1800S Solar Generator continue operating. You can test the surge capabilities of the Eco1800S Solar Generator by turning connected products on and off while the unit is unplugged. If products fail to operate or the screen shows an error code, see "Troubleshooting".

## 12V DC POWER PORT

The Eco1800S Solar Generator includes a 12V DC power port for operating common DC auto accessories up to 12 amps from the internal 12-volt battery. If the 12V DC power port is overloaded a protective internal breaker will open (interrupt) current flow. When the overloading accessory is disconnected, the breaker will automatically re-close (reset) within a few minutes.

**IMPORTANT:** When powering the 12V DC accessory, do not allow the Eco1800S Solar Generator internal battery to be discharged completely (i.e., 0% state-of-charge) which can permanently damage the internal battery. To avoid over-discharging the internal battery, do not leave any DC accessory including mobile phone chargers or other portable appliances permanently connected to the Eco1800S Solar Generator's 12V DC power port. See also Warning below.

**NOTE:** The Battery Charge (%) reading on the top panel display (when turned on) is only accurate after the Eco1800S Solar Generator internal battery has been resting (not charging or discharged) for at least 30 minutes.

## RUN TIME ON TYPICAL PRODUCTS

Product	Watts <sup>a</sup>	Run Time <sup>b</sup>
Cordless Phone	40	12.5 Hrs
Cell Phone	20	25 Hrs
Internet Modem	15	33 Hrs
Inkjet Printer	50-75	46 Hrs
Clock Radio	10	50 Hrs
Laptop Computer	20-140	2-25 Hrs
20" LCD Monitor	52	7.5 Hrs
Table Lamp	40	12.5 Hrs
13" TV	60	11 Hrs
Desktop Computer	80-450	15 min-6 Hrs
8.8 cu. ft. Freezer	200	1Hr
18 cu. Foot Fridge	500	15 min
Sump Pump 1/2 HP	500 1/4HP	15 min
Microwave	900-1600	5-12 min

## RUN TIME ON TYPICAL PRODUCTS

Product	Run Time <sup>b</sup>
Laptop, Inkjet Printer, Cordless Phone, Internet Modem	up to 3 Hrs
Desktop Computer, 17" LCD Monitor, Inkjet Printer, Internet Modem, Cordless Phone	up to 1 Hr
Cordless Phone, 13" TV, Clock Radio, Table Lamp	up to 3 Hrs

a. Average power consumption as measured on loads tested under typical operating conditions. Rated power may differ from average power consumption.

b. Run times are typical, not minimum. Actual run time may vary.

# POWER MANAGEMENT TIPS

During a power outage you are limited to stored energy in a battery versus continuous operating time on utility power. Maximizing Eco1800S Solar Generator's run time is essential to keep your home/small office running or to stay connected to the outside world through TV and radio news or cellphone/cordless phone. Therefore, in order to maximize the run time for combinations of office products plugged into Eco1800S Solar Generator, use the following alternatives:

USE...	Instead of...
Appliances Conservatively	Leaving appliances on unused until they drain the internal battery
Laptop or Desktop Computer with LCD Monitor	Desktop computer with CRT monitor
Monitor energy saving mode settings	Bright monitor settings
7" or 13" TVs	Big screen TVs
Small Desk Lamps (25 to 40w)	High-wattage lamps

## ! WARNING

### SHOCK HAZARD

Do not insert objects including your fingers and other body parts in the 12V DC power port. Turning the Power button off on the Eco1800S Solar Generator's top panel will not turn the 12V DC power port off.

## TROUBLESHOOTING

Please refer to the chart on the next page for Eco1800S Solar Generator troubleshooting.

Condition	Top Panel Display LED Status	Alarm Status	Alarm Stops Sounding When...
<b>Normal operation:</b> Utility power is available and unit is turned on. The internal battery is fully charged.	AC Power LED and Charged/Charging LED are solid green. Screen shows "FUL."	None	Not applicable.
<b>Backup power:</b> Utility power is not available. Unit supplies power from its internal battery.	Battery LED is flashing amber.	One beep when the power outage occurs.	Utility power becomes available; unit resumes normal operation or when it is turned off.
<b>Low battery warning:</b> During backup power operation, the internal battery is close to being completely discharged.	Battery LED is flashing amber. Screen shows Error Code E05.	Beeps once every 2 seconds.	Utility power becomes available; unit resumes normal operation or when it is turned off.
<b>Overload shutdown:</b> During backup power operation an AC outlet overload was detected.	Fault LED on. Screen shows Error Code E03.	One beep per second. Unit shuts down after 10 seconds.	Utility power becomes available; unit resumes normal operation or when it is turned off.
<b>Under-voltage shutdown:</b> During backup power operation the battery power has been completely exhausted. No power is available at the AC outlets.	Fault LED on. Screen shows Error Code E01.	One beep per second. Unit shuts down after 10 seconds.	Not applicable. Unit starts recharging the internal battery when utility power is restored. Turn on the unit to restore normal operation.
<b>Over-temperature warning:</b> During backup power operation, the unit is close to shutting down to protect its internal circuitry from high temperatures.	Fault LED on. Screen shows error code E06.	Beeps once every 2 seconds.	Better ventilation is provided to the unit, or the unit enters over-temperature shutdown, or the unit is turned off.
<b>Over-temperature shutdown:</b> Unit has shut down to protect its internal circuitry from high temperatures.	Fault LED on. Screen shows error code E04.	One beep per second.	The unit is turned off or when the unit shuts down.
<b>Recharging internal battery:</b> Unit is recharging its internal battery after utility power has been restored. Internal fan is running.	AC Power LED is green. Charged/Charging LED flashshows "CHG" alternating with battery capacity (%).	No Sound.	Not applicable. Screen shows "FUL" when unit is completely charged.

# TROUBLESHOOTING CONT.

## OPERATING THE PV SOLAR INPUT

The PVCC will initiate a new charge cycle when solar input energy is first connected and there is sufficient energy to activate it. The PVCC includes Pulse Width Modulation (PWM) circuitry that accepts input energy to charge up to 8amps until reaching 14.4–14.8 volts (battery), then maintain this absorption voltage for four hours, then finally transfer to float mode attempting to maintain 13.5volts. While in float mode, if the battery voltage drops below 12.5volts, the charger will initiate a new charge cycle (provided there is sufficient PV Solar energy available).

PV Solar status LED	Description, action(s) to take
OFF	<ul style="list-style-type: none"> <li>• Insufficient energy available to charge</li> <li>• Ensure PV panel is connected</li> <li>• Expose panel to bright direct sunlight</li> <li>• Test/ensure input voltage from panel is at 15V at the PVCC connector (prior to connecting to the PVCC).</li> </ul>
ON Flashing	<ul style="list-style-type: none"> <li>• Bulk/Absorption charging</li> <li>• Wait for full charge to be achieved</li> </ul>
ON Steady	<ul style="list-style-type: none"> <li>• Full charge has been achieved</li> <li>• PVCC now in float mode</li> </ul>

**NOTE:** The PVCC operation description assume a continuous adequate level of PV energy available to the PV Charge Controller. Due to the potentially variable output of a solar panel due to changing weather and panel's orientation to the sun, the charge algorithm/time may be extended, stopped, restarted without notice. If sufficient charge capacity is not available from solar source, connect the Eco1800S Solar Generator to 120 VAC utility power to allow the AC five-amp charger to assist in completing the battery charge.

## 12V DC POWER PORT

The Eco1800S Solar Generator includes a 12V DC power port for operating common DC auto accessories up to 12 amps from the internal 12-volt battery. If the 12V DC power port is overloaded a protective internal breaker will open (interrupt) current flow. When the overloading accessory is disconnected, the breaker will automatically re-close (reset) within a few minutes.

**IMPORTANT:** When powering the 12V DC accessory, do not allow the Eco1800S Solar Generator internal battery to be discharged completely (i.e., 0% state-of-charge) which can permanently damage the internal battery. To avoid over-discharging the internal battery, do not leave any DC accessory including mobile phone chargers or other portable appliances permanently connected to the Eco1800S Solar Generator's 12V DC power port. See also Warning below.

**NOTE:** The Battery Charge (%) reading on the top panel display (when turned on) is only accurate after the Eco1800S Solar Generator internal battery has been resting (not charging or discharged) for at least 30 minutes.

## UNDERSTANDING ERROR CODES

If the products connected to Eco1800S Solar Generator do not operate and the alarm is sounding, check the Eco1800S Solar Generator top display LED screen for an error code.

ERROR	POSSIBLE CAUSE	SOLUTION
E01	Low voltage shutdown because battery is discharged.	Recharge battery by plugging the AC power cord into a wall outlet.
E03	<p>Overload shutdown while supplying backup power. The AC product(s) connected are consuming more than Eco1800S Solar Generator's power rating.</p> <p>The AC products connected have a surge power that exceeds Eco1800S Solar Generator's surge capability.</p> <p>One or more of the connected products are damaged.</p>	<p>Use products with a total power consumption within Eco1800S Solar Generator's continuous power rating of 1440W.</p> <p>Use products with a total starting surge power within Eco1800S Solar Generator's capability of 2880 W.</p> <p>Have the damaged product serviced by a qualified technician.</p>
E04	Over-temperature shutdown has occurred. Eco1800S Solar Generator has overheated due to poor ventilation, excessive ambient temperature, or power demand beyond the unit's output power capability.	Disconnect products from the AC outlets. Allow the unit to cool for 20 minutes. Clear blocked fan or remove objects covering unit. Move the unit to a cooler place. Reduce load to less than 1800W if continuous operation is required.

## TROUBLESHOOTING CONT.

ERROR	POSSIBLE CAUSE	SOLUTION
E05	Under-voltage warning. The battery is nearly discharged.	Reduce the load to extend run time during backup mode. Assuming the AC power cord was unplugged and the unit turned to backup mode, when utility power is present or becomes available, recharge the battery by plugging the AC power cord into a wall outlet.
E06	Over-temperature warning. Eco1800S Solar Generator is overheating due to poor ventilation, excessive ambient temperature, or high power demand.	Reduce the load to avoid over-temperature shutdown, clear blocked fan or remove objects covering unit, or move the unit to a cooler place.

PROBLEM	PROBLEM/SYMPPTOM	SOLUTION
Eco1800S Solar Generator will not turn on.	Battery is discharged and utility power is not available at the wall outlet.	Ensure power is available at the wall outlet.
No power available at the 120VAC outlets.	AC outlet has been overloaded or the supplementary protector has tripped.	Reduce the number of products plugged into the AC outlets. Check the supplementary protector at the back of the unit. If necessary, reset the breaker by pushing it fully inward.
AC utility is not available and products connected to unit lose power.	Eco1800S Solar Generator has detected an overload condition.	Make sure the products plugged into the AC outlets are not exceeding the output power rating of the unit when supplying backup power. Try removing or substituting some of the products.

PROBLEM	PROBLEM/SYMPPTOM	SOLUTION
AC utility is not available and products connected to unit lose power.	Eco1800S Solar Generator has detected an over-temperature condition.	Disconnect products from the AC outlets. Make sure the products plugged into the AC outlets are not overloading the continuous output power rating of the unit when supplying backup power. Allow the unit to cool, increasing ventilation if necessary. If the unit is left on, it restarts automatically when the unit cools down.
	Eco1800S Solar Generator has exhausted its available battery power.	Eco1800S Solar Generator shuts down when all available battery power has been used. Allow the unit to recharge for 15 hours before continuing to use the unit.
AC utility is not available and products connected to unit lose power.  Products connected to unit malfunction or overheat.  Inadequate run time.	Eco1800S Solar Generator may require service.	Contact UPG Customer Service for further troubleshooting toll free at 866.892.1122.
	Products connected to Eco1800S Solar Generator do not accept modified sine wave form.	Your application is not compatible with Eco1800S Solar Generator's modified sine wave output.
	Eco1800S Solar Generator's battery is not fully charged.	Charge the battery by leaving Eco1800S Solar Generator plugged into a wall outlet at least 18 hours.
	Battery is near the end of its useful life.	Press for at least half a second to turn unit on.
	Eco1800S Solar Generator has turned off.	As the battery ages, the available run time decreases. The internal battery also ages prematurely if Eco1800S Solar Generator is installed in a hot environment or not kept in a charged condition.

# WARRANTY AND RETURN INFORMATION

---

## What does the warranty cover?

This Limited Warranty is provided by Universal Power Group (“UPG”) and covers defects in workmanship and materials in your Eco1800S Solar Power Generator. This warranty period lasts for 1 year for the generator and 5 years for the solar panel output power and 90 days on solar panel frame from the date of purchase as the point of sale to end use customer. You will be required to demonstrate proof of purchase to make warranty claims.

This Limited Warranty is transferable only for the unexpired portion of the Warranty Period. Subsequent owners also require original proof of purchase as described in “What proof of purchase is required?”

## What will UPG do?

UPG will, at its option, repair or replace the effective product free of charge, provided that you notify UPG of the product within the Warranty Period, and provided that UPG through inspection establishes the existence of such a defect and that it is covered by this Limited Warranty.

UPG will, at its option, use new and/or reconditioned parts in performing warranty repair and building replacement products. UPG reserves the right to use parts or products of original or improved design in the repair or replacement. If UPG repairs or replaces a product, its warranty continues for the remaining portion of the original Warranty Period or 90 days from the sale of the return shipment to the customer, whichever is greater. All replaced products and all parts removed from repaired products become the property of UPG. UPG covers both parts and labor necessary to repair the product, and return shipment to the customer via a UPG-selected non-expedited surface freight within the contiguous United States and Canada. Alaska and Hawaii are excluded. Contact UPG Customer Service for details on freight policy for return shipments outside of the contiguous United States and Canada.

## How do you get service?

If your product requires troubleshooting or warranty service, contact your merchant. If you are unable to contact your merchant, or the merchant is unable to provide service, contact UPG directly at:

Telephone: 1.866.892.1122 (direct)  
Email: [warranty@upgi.com](mailto:warranty@upgi.com)

Direct returns may be performed according to the UPG Return Material Authorization Policy described in your product manual. For some products, UPG maintains a network of regional Authorized Service Centers. Call UPG or check our website to see if your product can be repaired at one of these facilities.

## What proof of purchase is required?

In any warranty claim, dated proof of purchase must accompany the product and the product must not have been disassembled or modified without prior written authorization by UPG. Proof of purchase may be in any one of the following forms:

- The dated purchase receipt from the original purchase of the product at point of sale to the end use, or
- The dated dealer invoice or purchase receipt showing original equipment manufacturer (OEM) status, or
- The dated invoice or purchase receipt showing the product exchanged under warranty.

## What does this warranty not cover?

This Limited Warranty does not cover normal wear and tear of the product or costs related to the removal, installations, or troubleshooting of the customer’s electrical systems. This warranty does not apply to and UPG will not be responsible for any defect in or damage to:

- a) The product if it has been misused, neglected, improperly installed, physically damaged or altered, either internally or externally, or damaged from improper use or use in an unsuitable environment;
- b) The product if it has been subjected to fire, water, generalized corrosion, biological infestations, or input voltage that creates operating conditions beyond the maximum or minimum limits listed in the UPG specifications including high input voltage from generators and lightning strikes;
- c) The product if repairs have been done to it other than by UPG or its authorized service centers (hereafter “ASCs”);
- d) The product if it is used as a component part of a product expressly warranted by another manufacturer;

