



JNH LIFESTYLES

JOYFUL NATURAL & HEALTHY LIVING

ASSEMBLY INSTRUCTIONS

A STEP-BY-STEP GUIDE
TO ASSEMBLE YOUR INFRARED SAUNA

Please read these instructions before assembling your infrared sauna for the first time. We recommend keeping this instruction manual for future reference.

Assembly Instructions

MODEL NUMBER:MG417HB/MG417RB

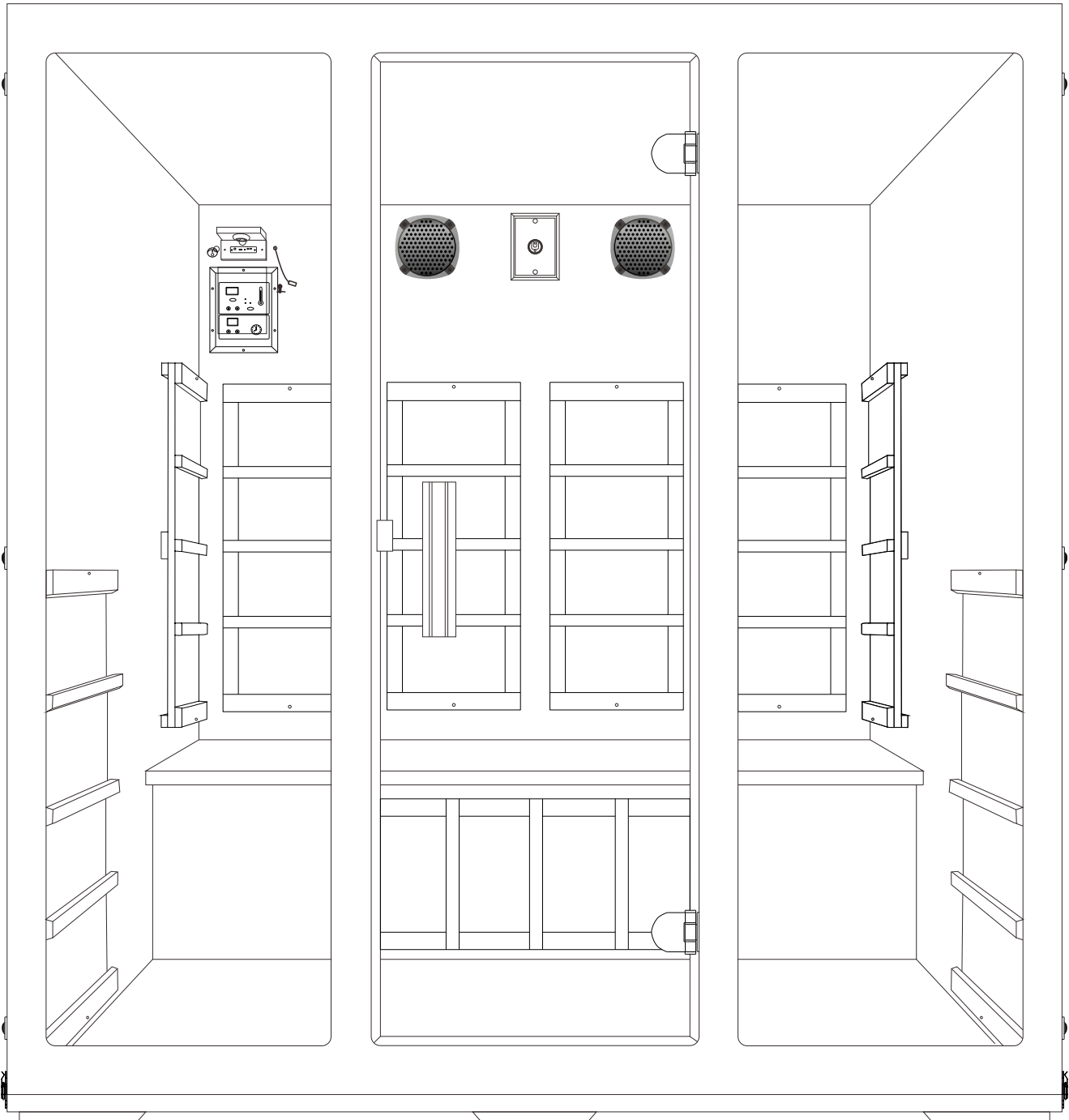

OVERVIEW DRAWING

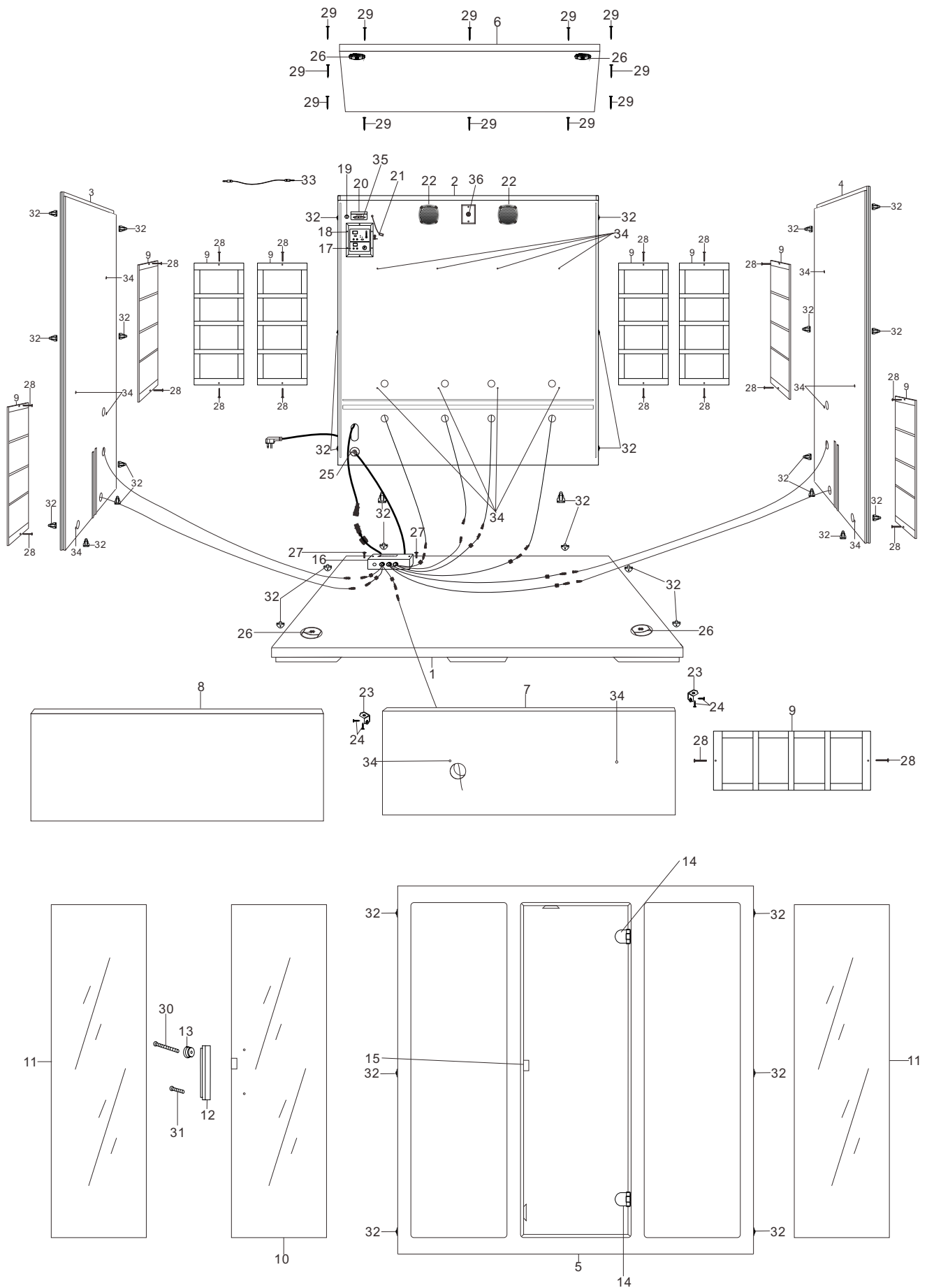



PARTS LIST

No.	Description	Qty	No.	Description	Qty
001	Bottom Panel	1	019	Switch	1
002	Rear Panel	1	020	LED Light	1
003	Left Panel	1	021	Cable for Oxygen Ionizer	1
004	Right Panel	1	022	Speaker	2
005	Front Panel	1	023	Fixed Part	2
006	Top Panel	1	024	3 x 16 Screw	4
007	Bench Support Panel	1	025	Power Cord Cover	1
008	Bench Panel	1	026	Vent	4
009	Heater	8	027	4 x 16 Screw	2
010	Glass Door	1	028	4 x 40 Screw	18
011	Glass Window	2	029	4 x 40 Screw	12
012	Door Handle	1	030	6 x 35 Screw	1
013	Round Handle	1	031	6 x 15 Screw	1
014	Door Hinge	2	032	Latch	18
015	Magnet	1	033	Cable for Mp3 Player	1
016	Power Supply	1	034	4 x 10 Internal Rope Thread	18
017	Control Panel	1	035	Mp3 Auxiliary Jack Panel	1
018	Control Panel Wood Frame	1	036	Chromo Light Socket	1

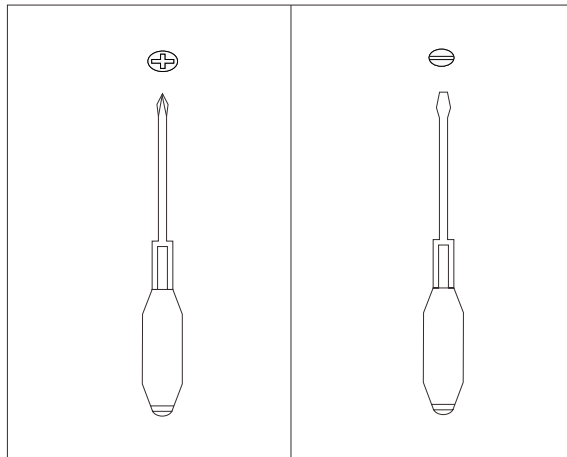
REQUIRED TOOLS:

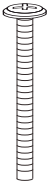

Hardware Included :

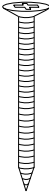
	LABEL	Qty	PURPOSE
 (27)	PMW4*16	2	For Power Box
 (28)	TM4*40	18	For Heater
 (24)	KA3*16	4	For Seat Bench
 (23)	—	2	For Seat Bench
 (29)	KA4*40	12	For Roof Panel

Questions on Installation? Contact (800) 528-3110.

OVERVIEW

Your Sauna will arrive in 3 boxes:

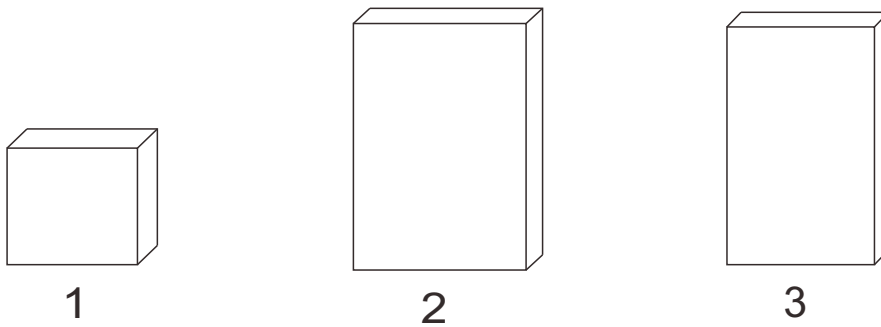

What is included in each box:

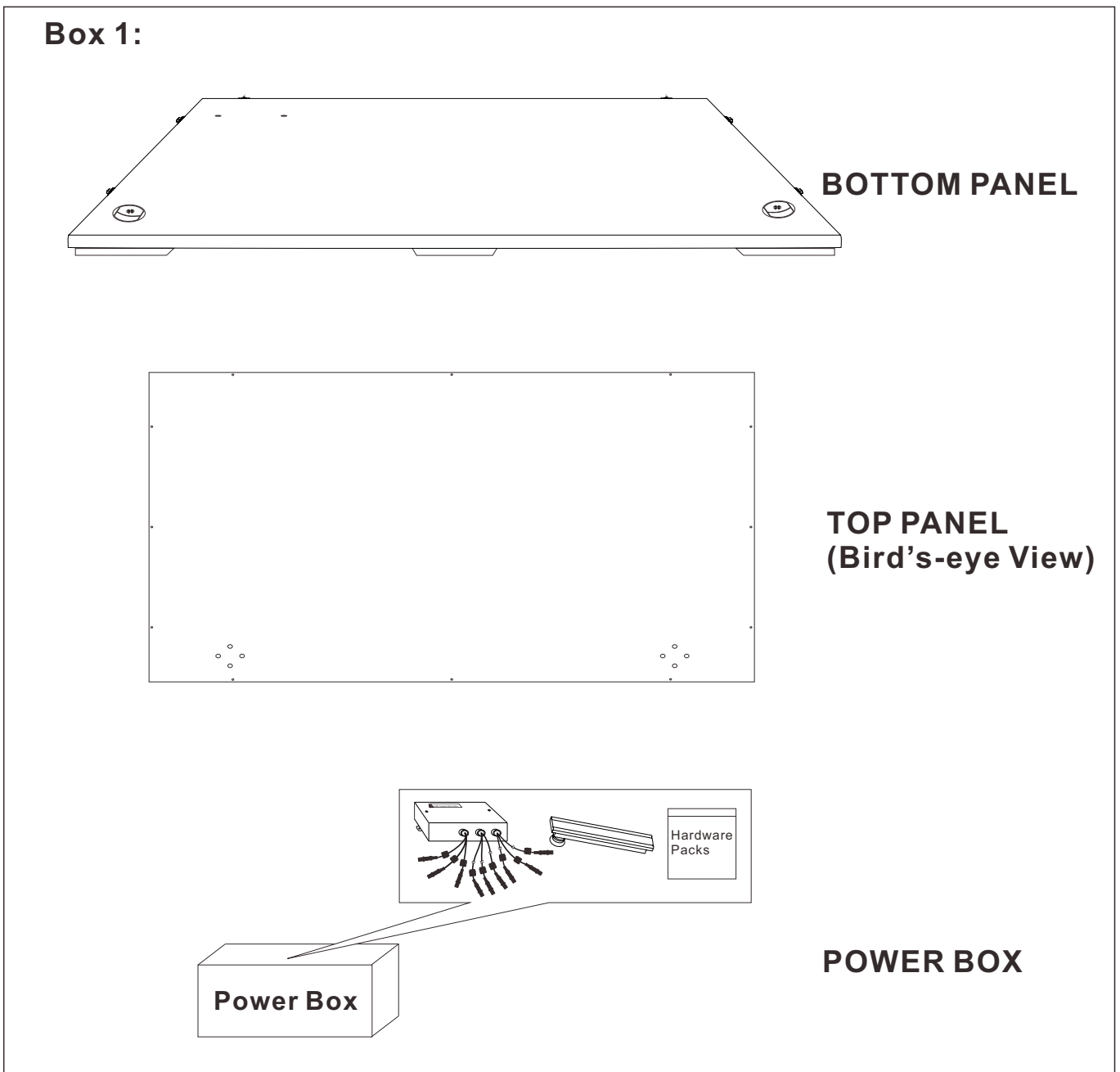

Box 1:

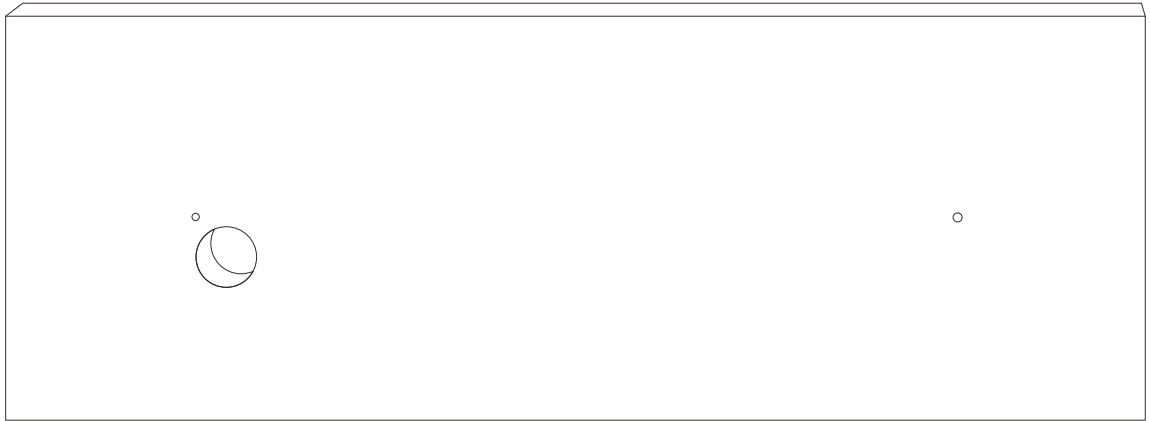

BENCH SUPPORT PANEL



BENCH PANEL

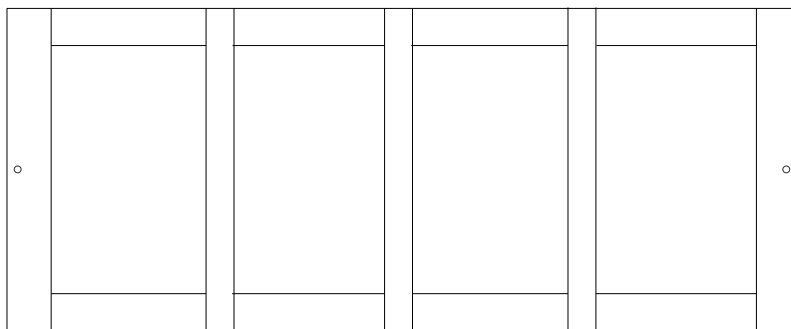

HEATER

Box 2:

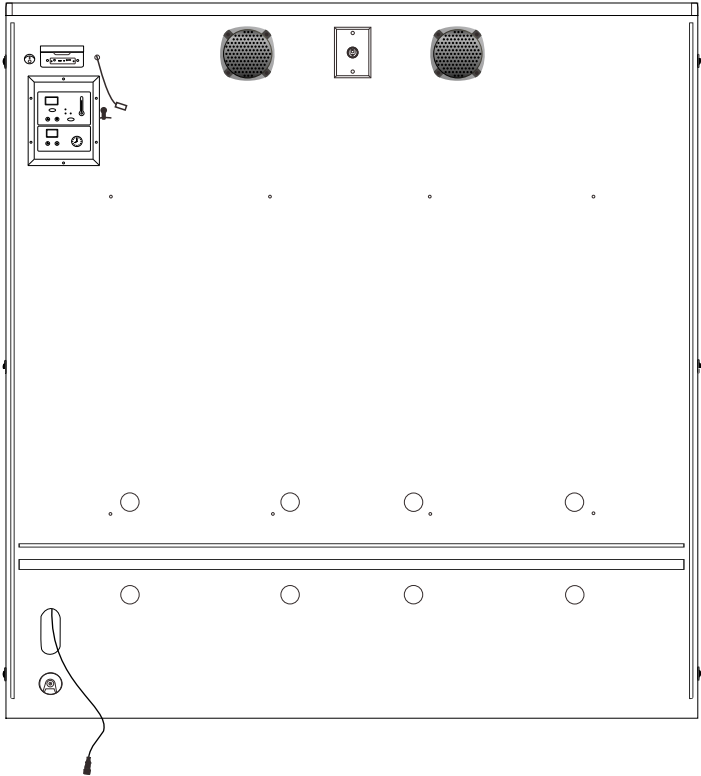

**REAR PANEL
(Interior View)**

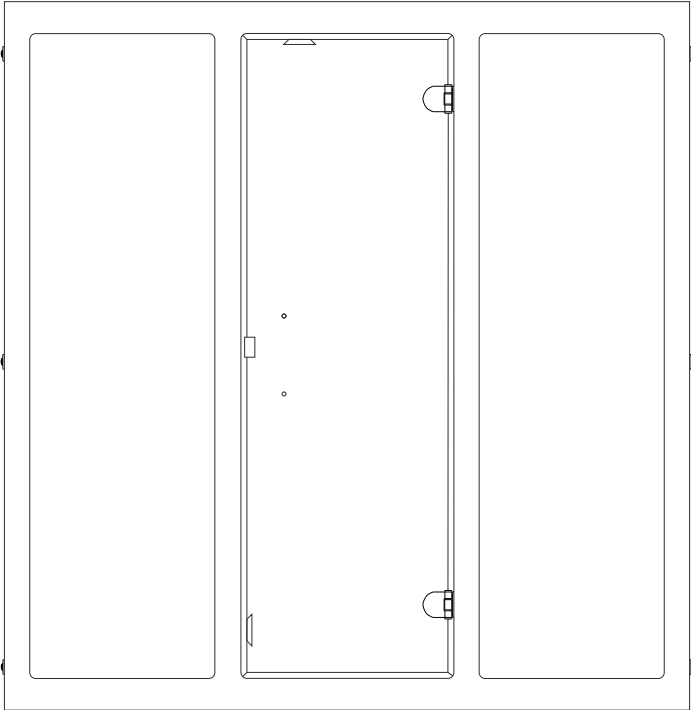

**FRONT PANEL
(Exterior View)**

Box 3:

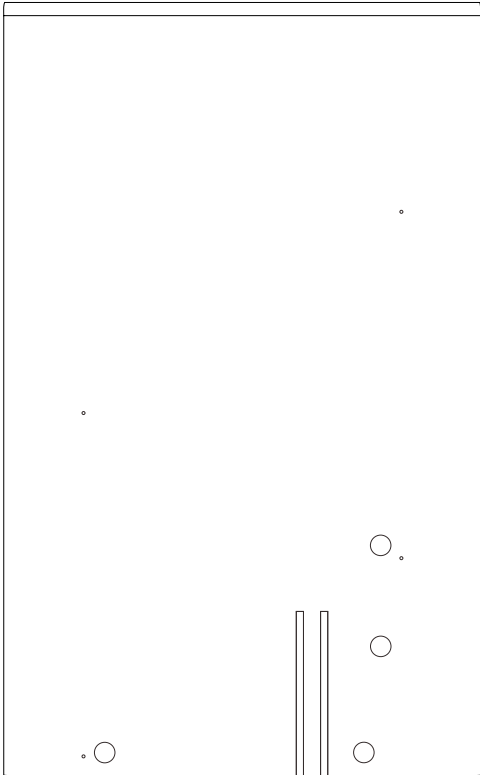

**LEFT PANEL
(Interior View)**

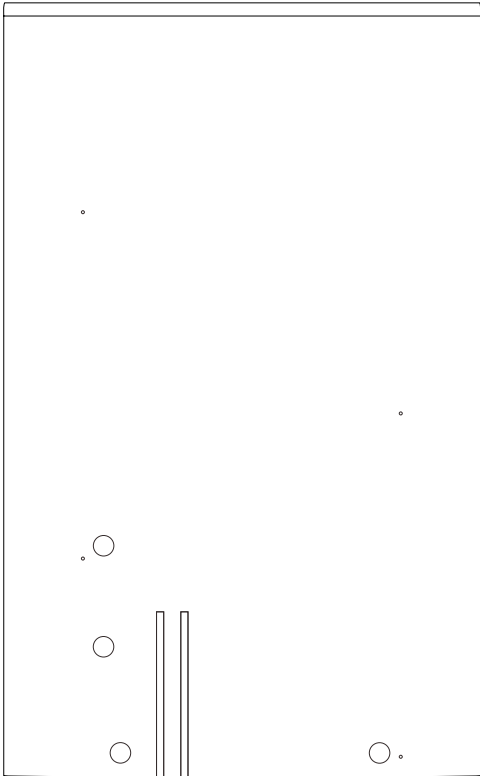

**RIGHT PANEL
(Interior View)**

Step-By-Step Assembly Instructions for MG417HB/MG417RB:

- ① Place the bottom panel on dry and level ground.

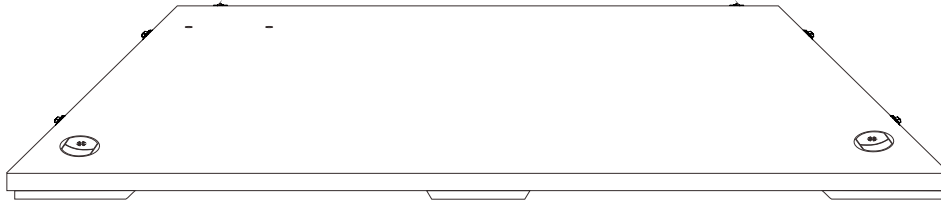

BOTTOM PANEL
(In Box 1)

- ② Attach the rear panel to the bottom panel using the tongue and groove. Confirm there are no gaps prior to latching.

REAR PANEL
(In Box 2)

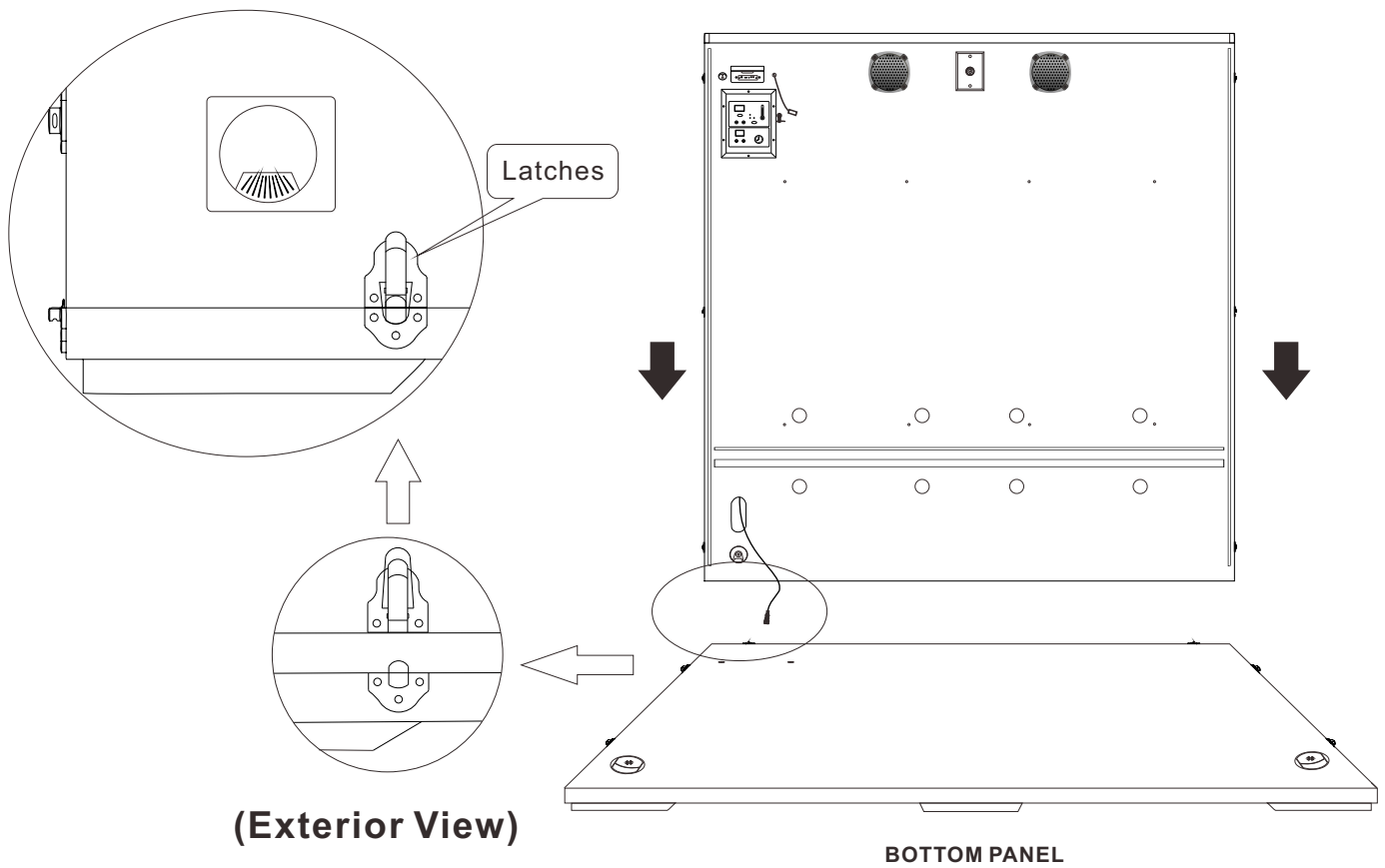

- ③ Attach the left panel to the rear and bottom panels using the tongue and groove. Confirm there is no gap prior to latching.

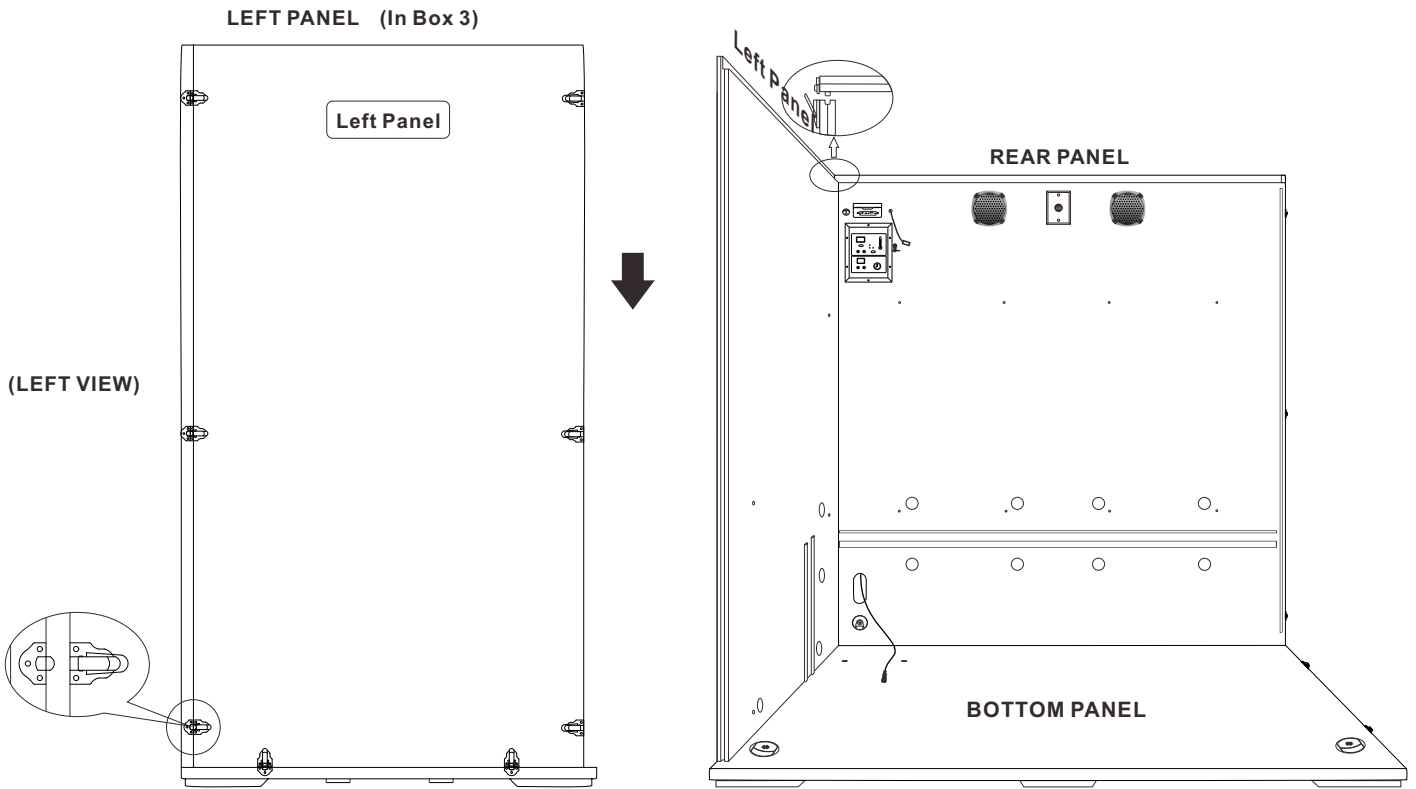

- ④ Attach the right panel to the rear and bottom panels using the tongue and groove. Confirm there is no gap prior to latching.

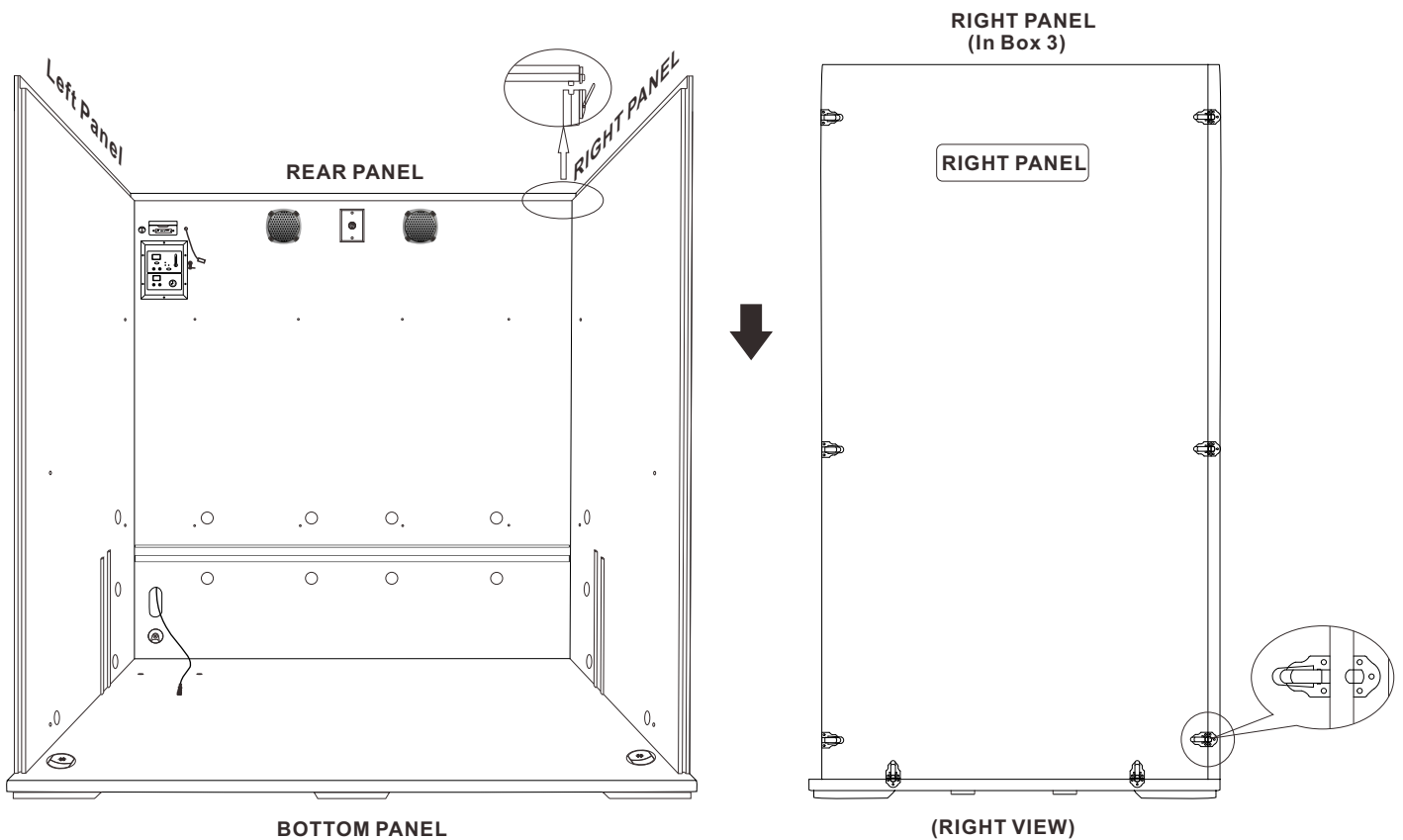

- ⑤ Place power box at designated space and tighten in place using two (2) PMW4*16 screws.

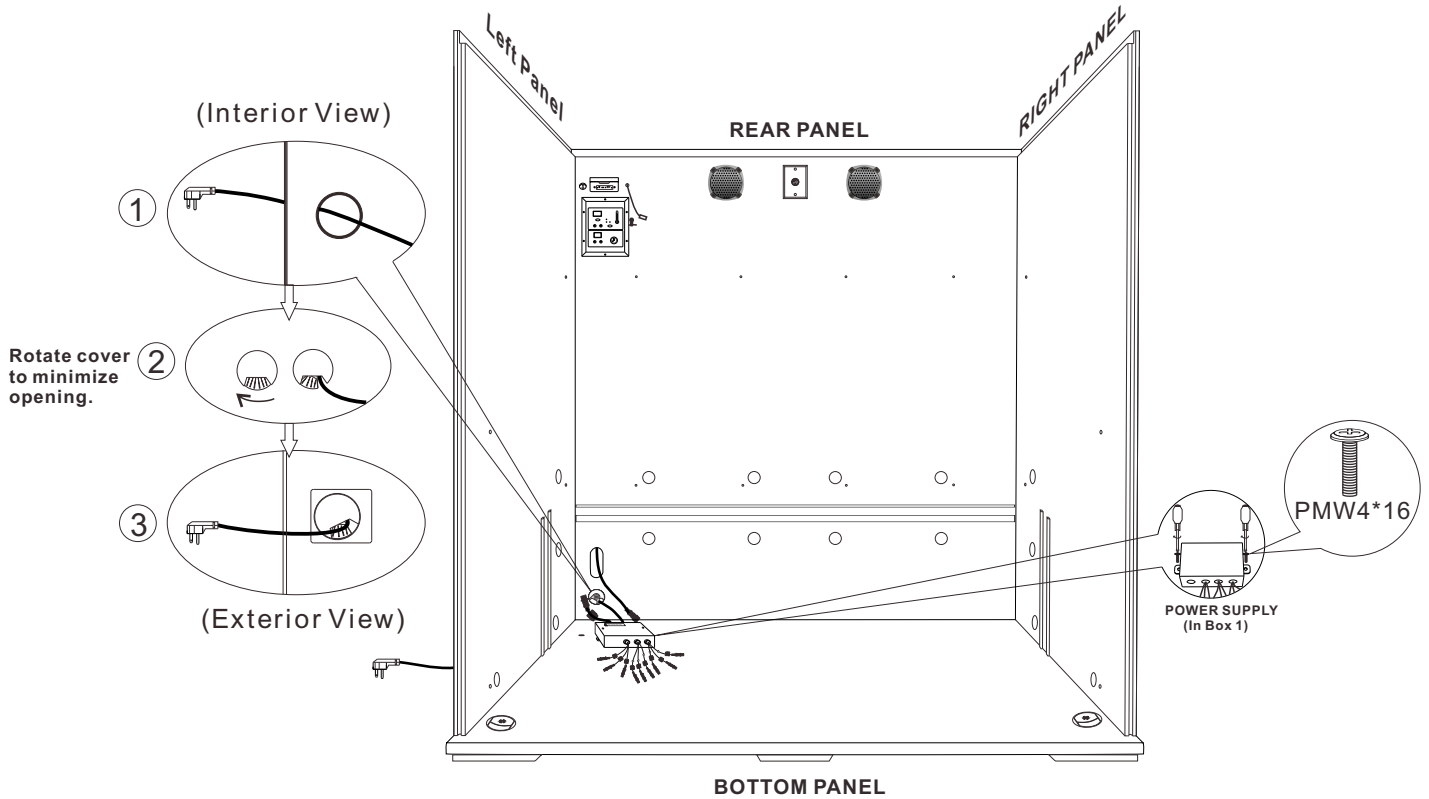

- ⑥ Attach four (4) heaters to the rear panel using TM4*40 screws. Connect heater cords to power box.

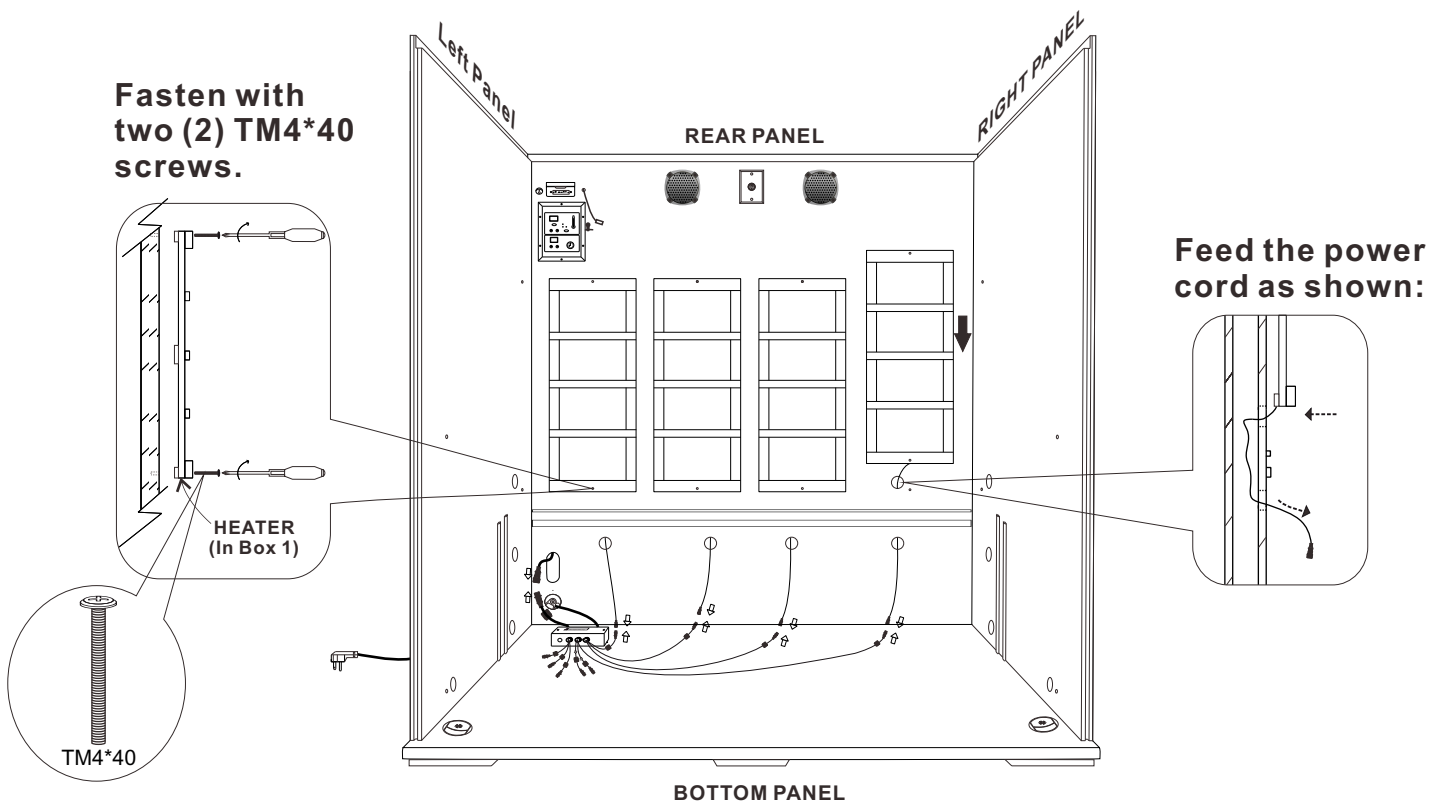

- ⑦ Attach two (2) heaters to both the left and right panels using TM4*40 screws. Connect heater cords to power box.

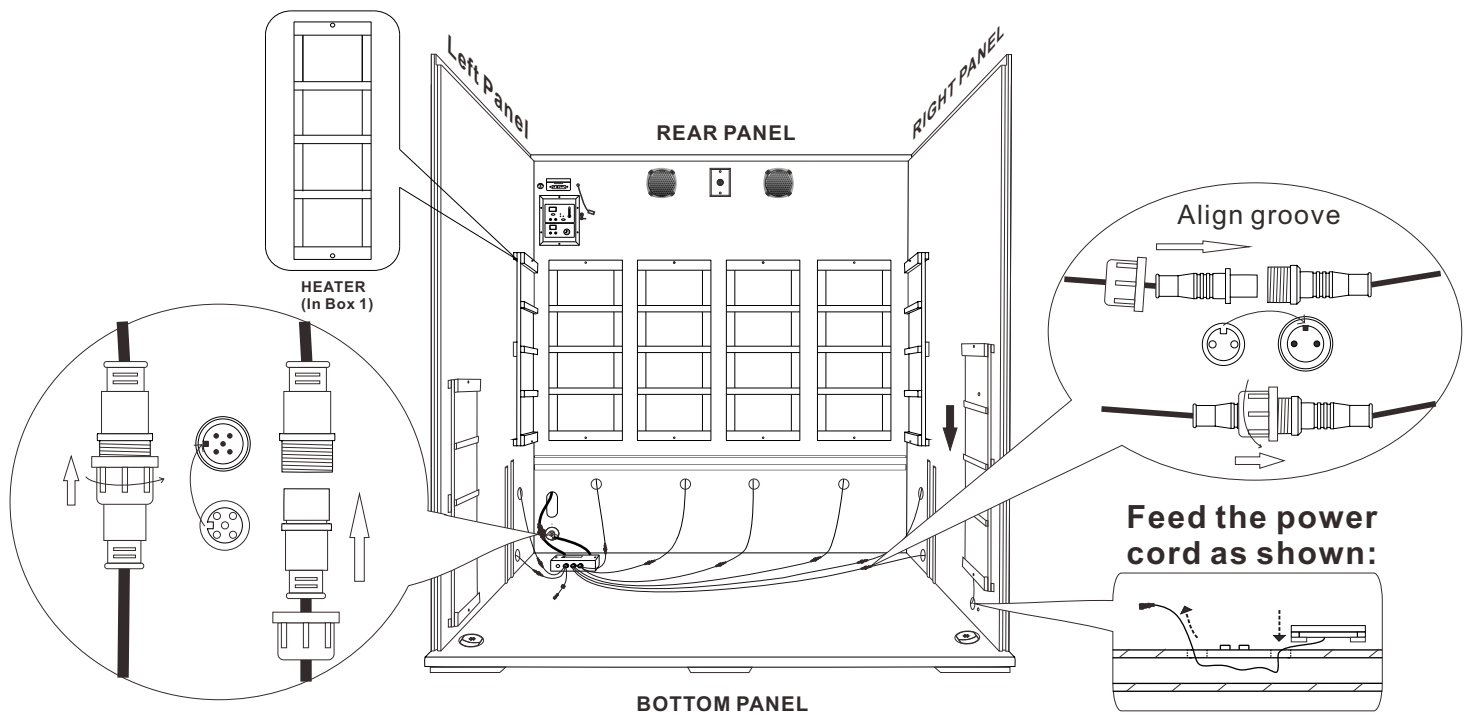

- ⑧ Attach a heater to the bench support panel. Fasten with two (2) TM4*40 screws.

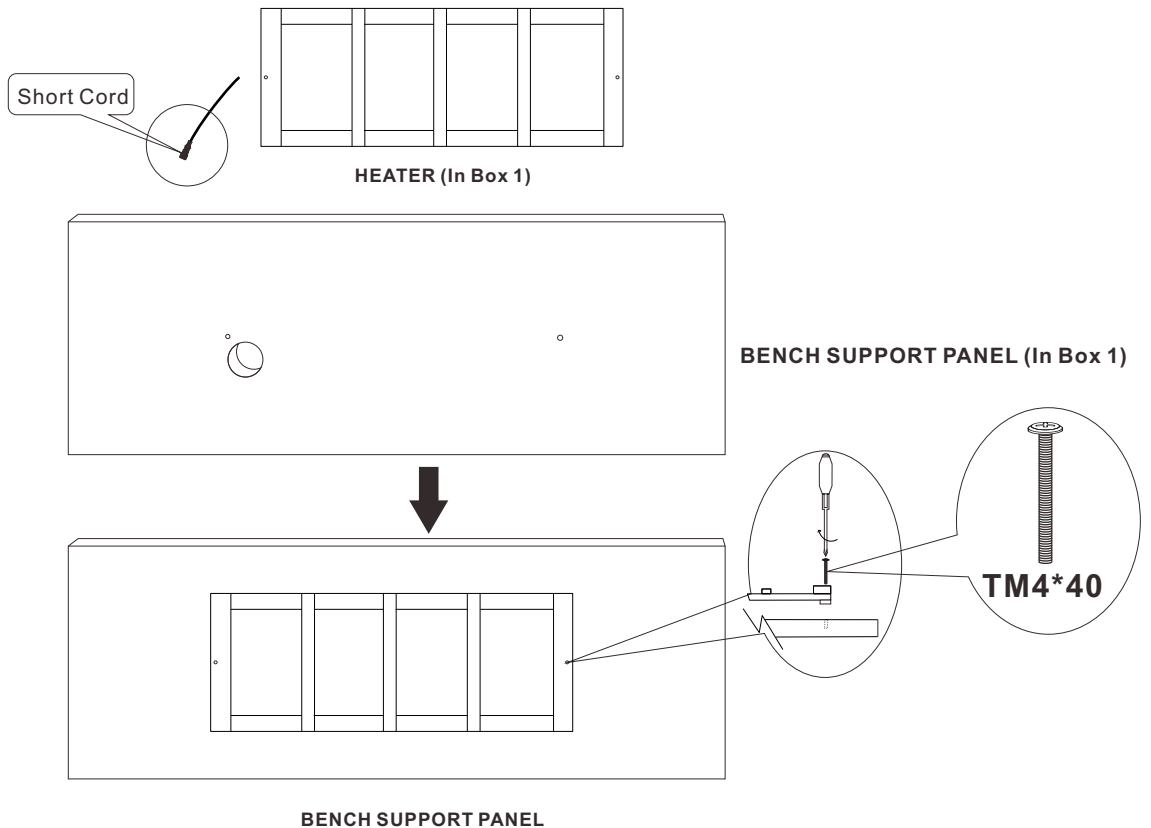

- ⑨ Slide the bench support panel in place and connect heater cords to power box.

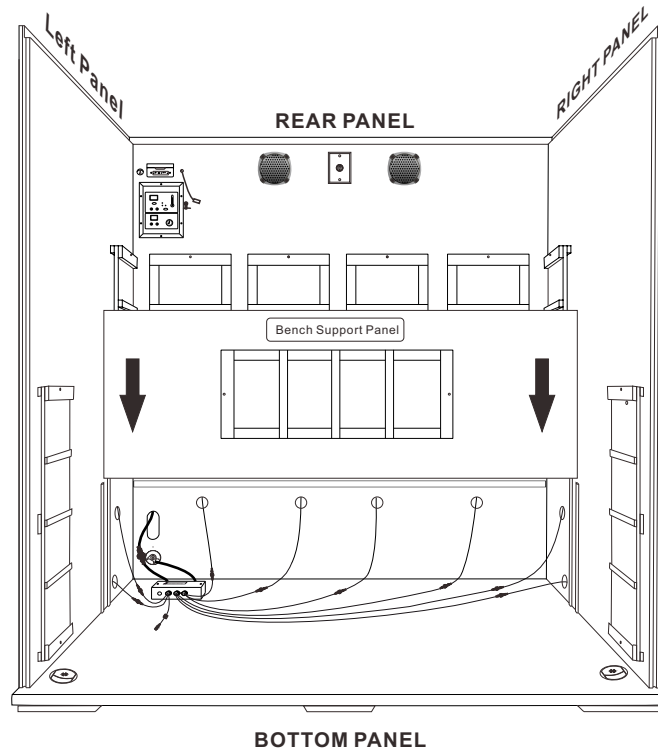

- ⑩ Place bench panel in place and screw brackets to the front of the bench panel, securing the bench support panel to the bench panel.

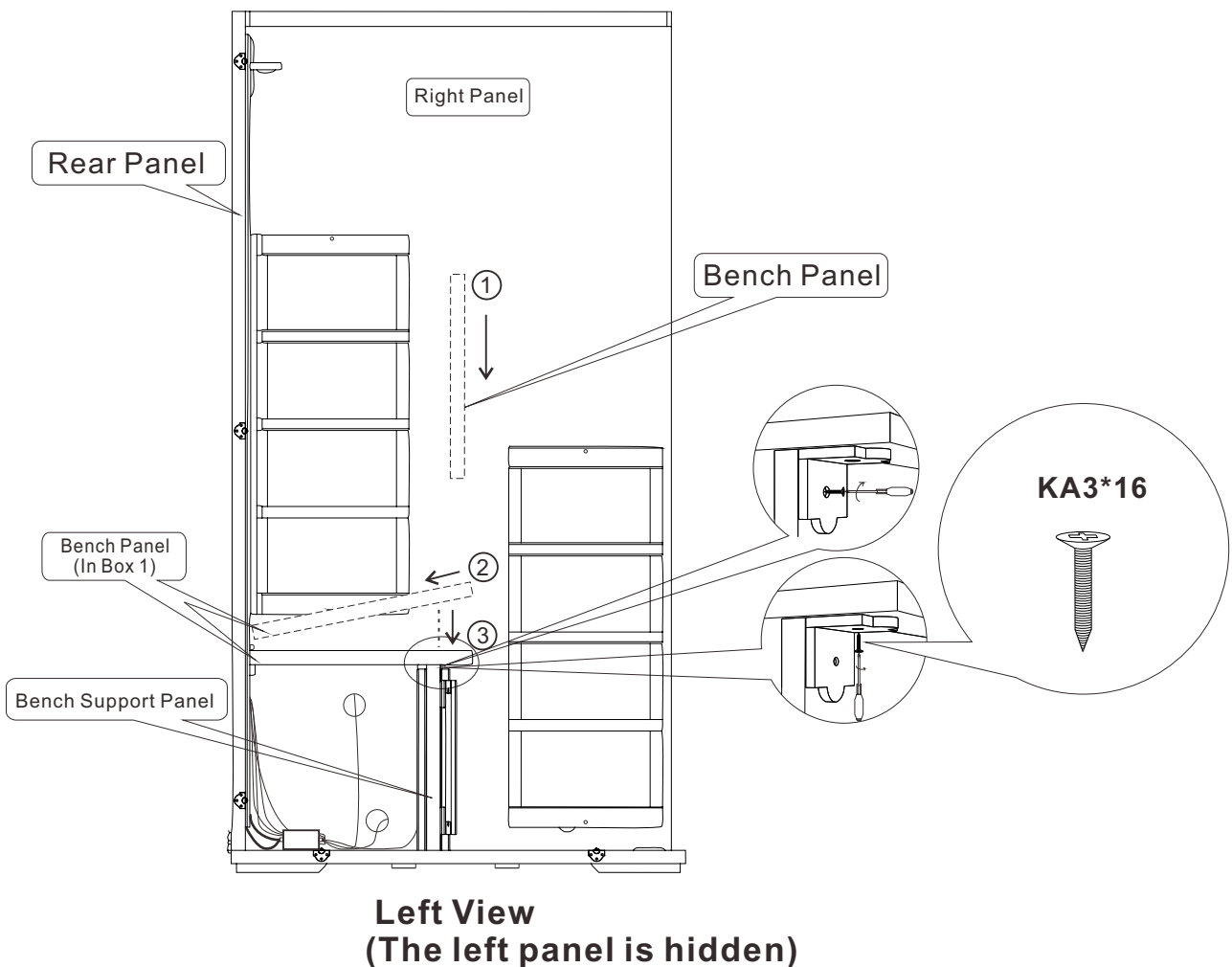

⑪ Attach the front panel to the unit and secure with latches.

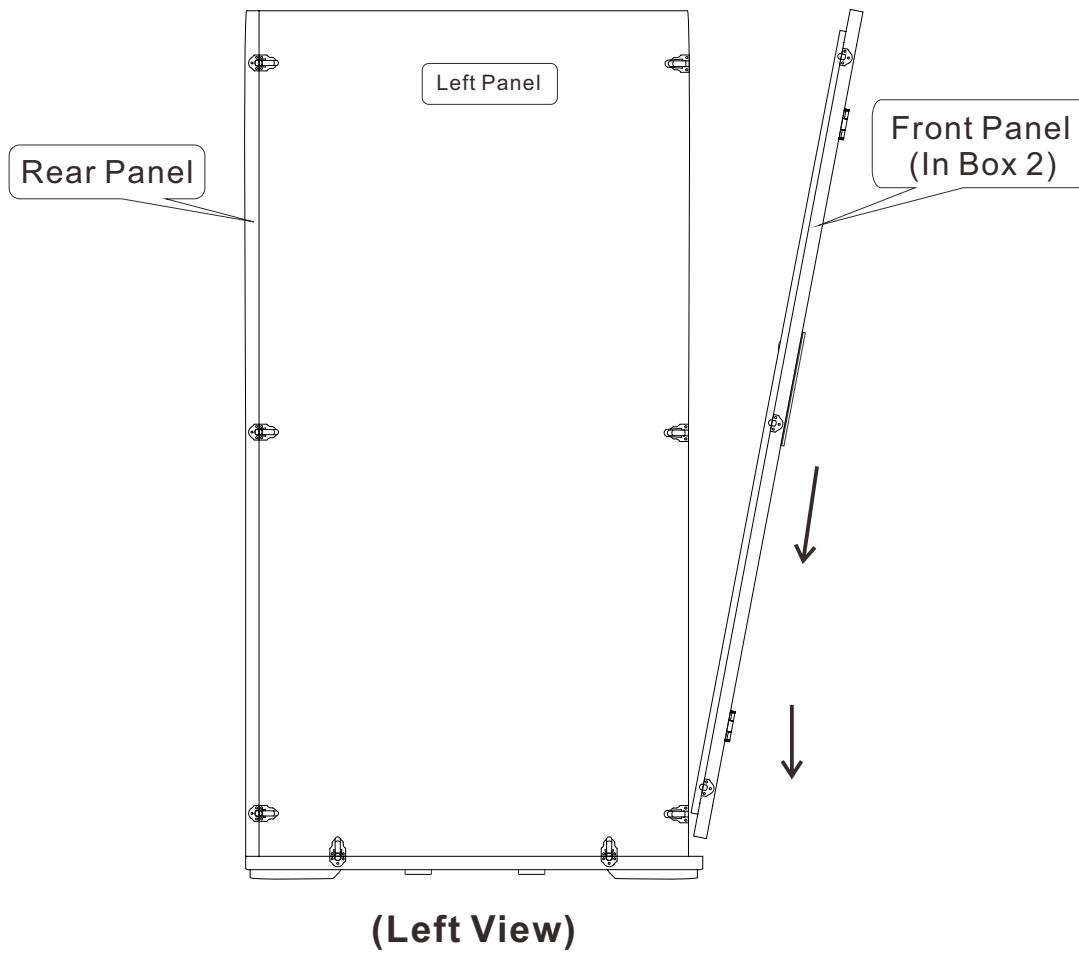

⑫ Use the screwdriver to remove the glass protectors on the glass panel.

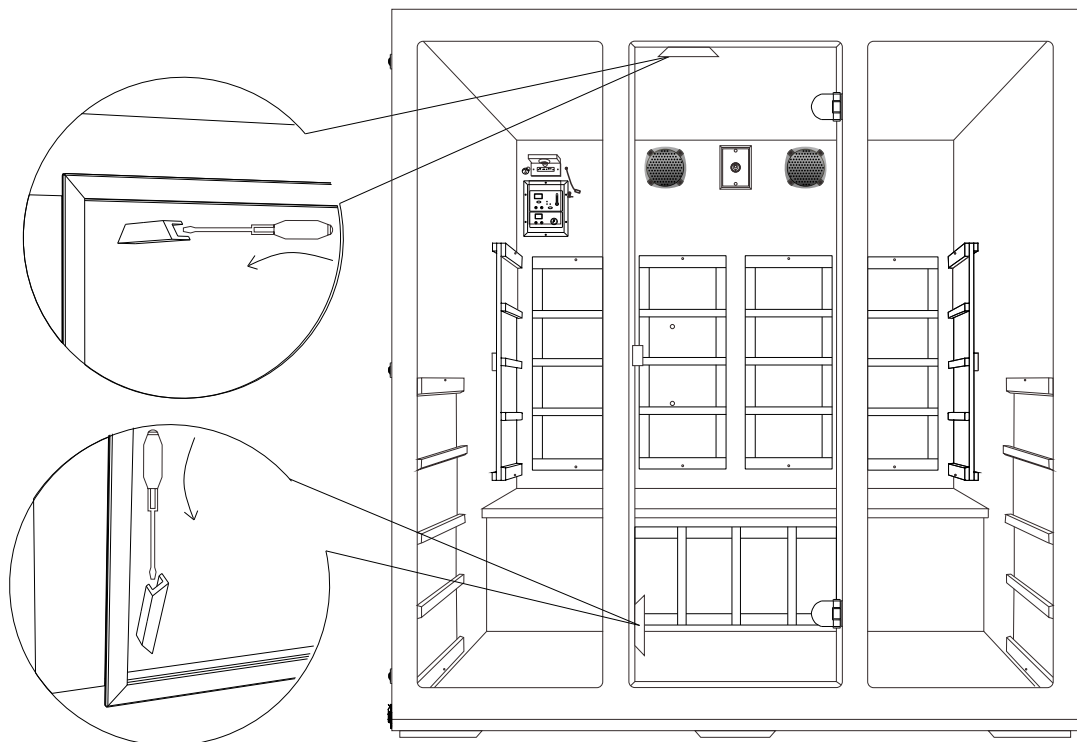

⑬ Drop the top panel in place (ensure the top panel is centered correctly).

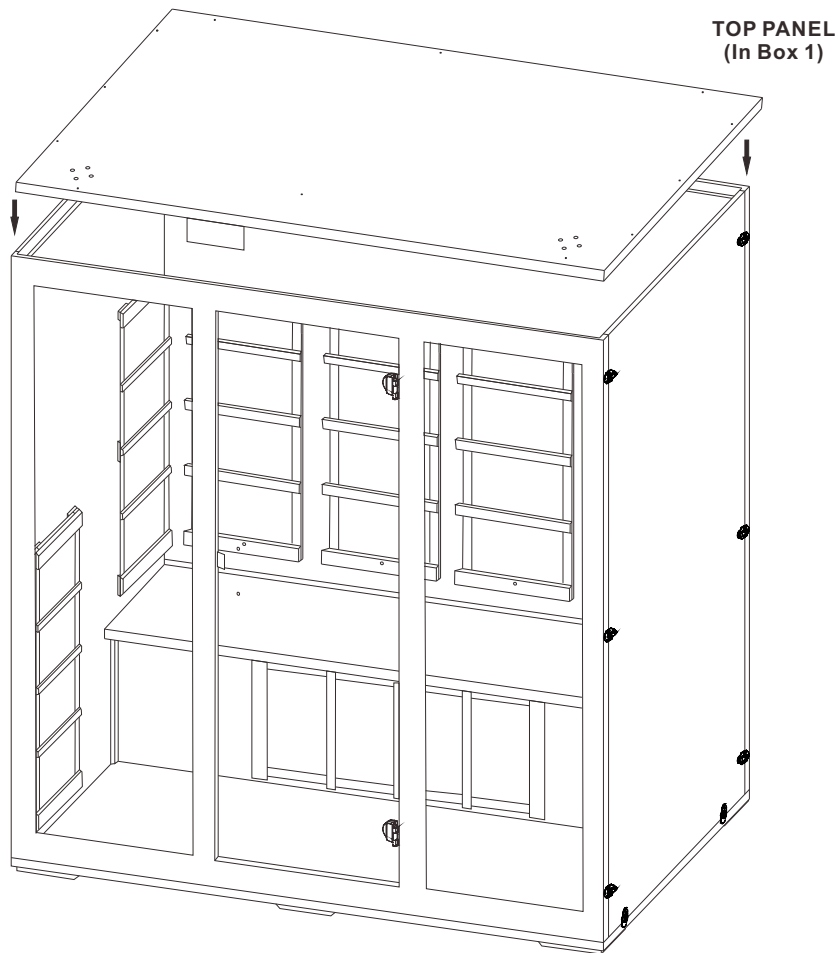

(Oblique View)

⑭ Please ensure the top panel is placed in the center. The clearance distance of L1, L2, L3 and L4 should all be the same.

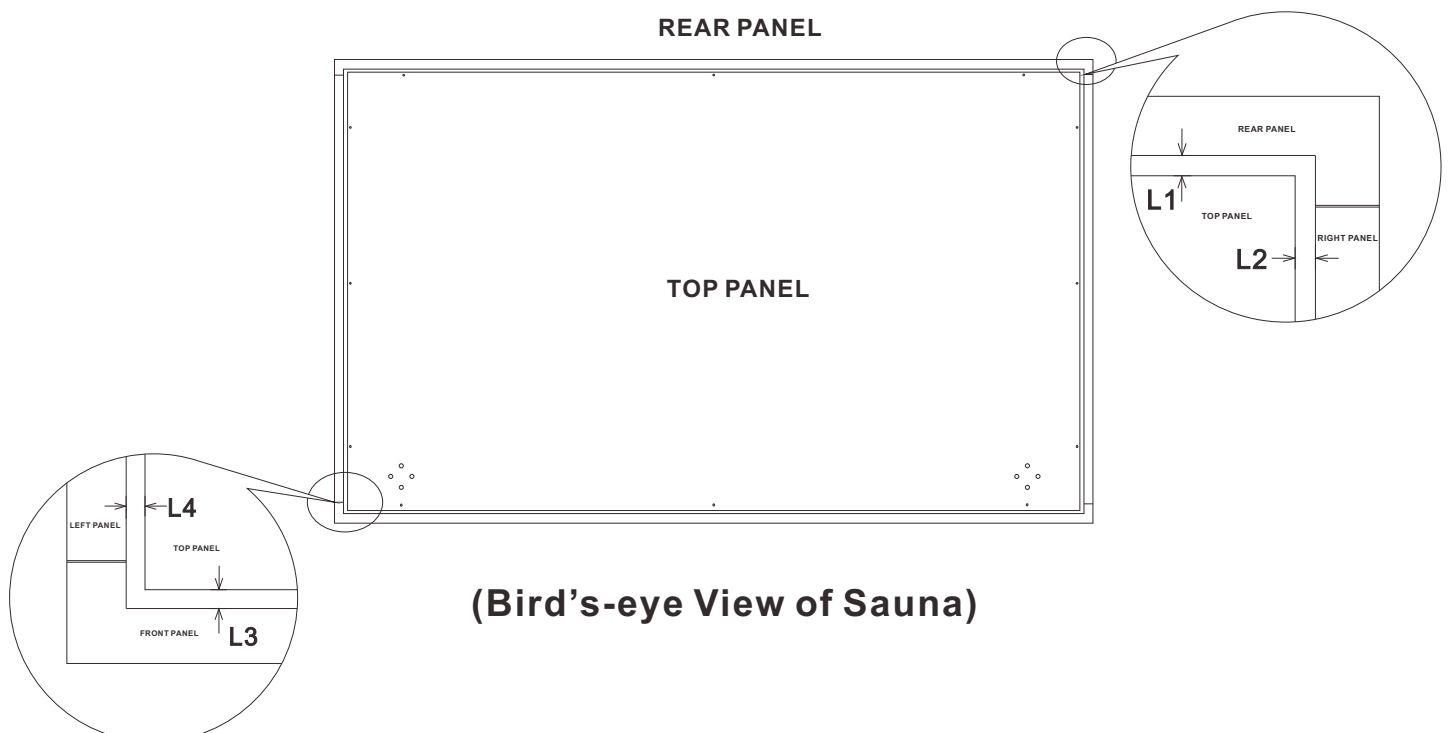

⑮ **Secure the top panel using twelve (12) KA4*40 screws.**

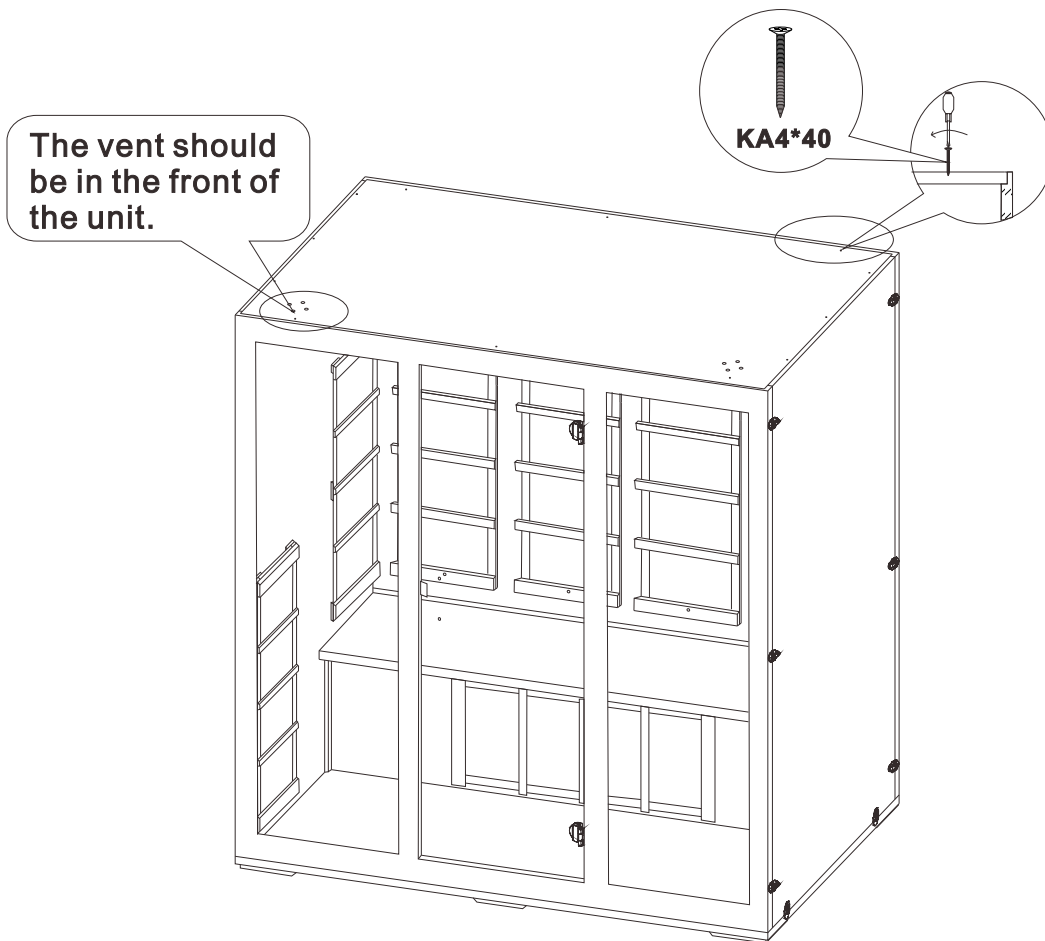

(Oblique View)

⑯ **Install door knob (place inside of the sauna, tighten with LONG SCREW) and door handle (place outside of sauna, tighten with SHORT SCREW).**

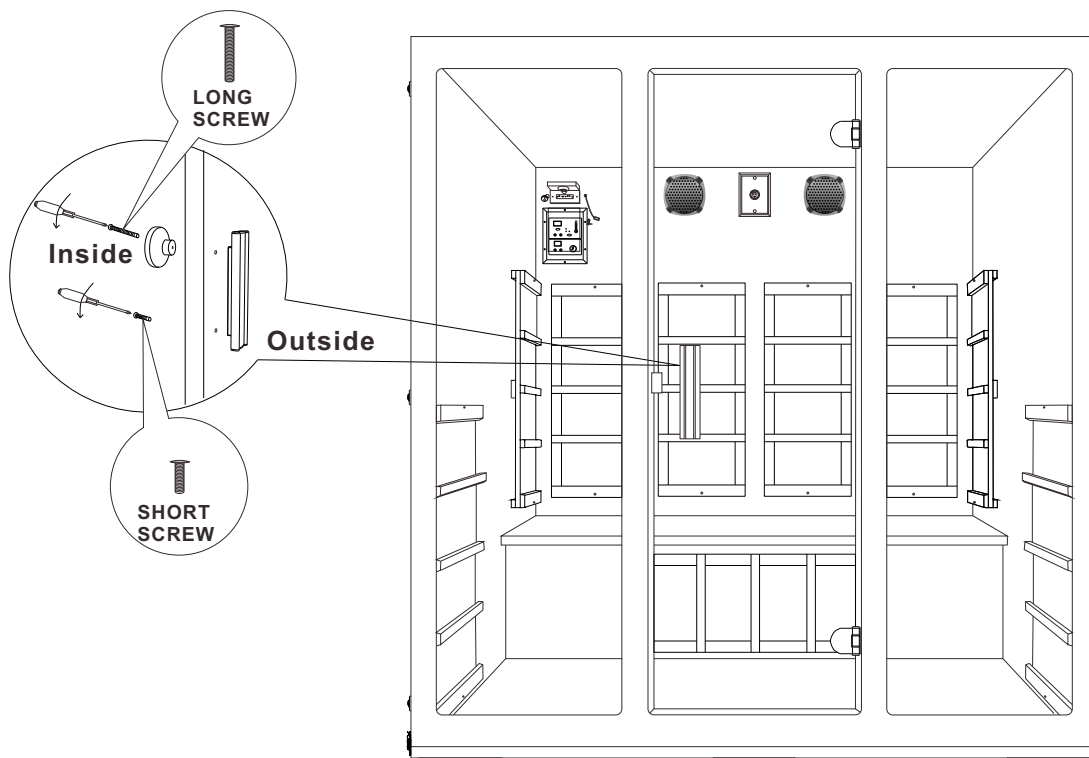

**Your sauna is ready to use.
Please read the user manual for instructions on
operating your sauna.**

