

# SONY®

## Digital Still Camera

### Operating Instructions

Before operating the unit, please read this manual and the separate sheet "Waterproof specifications" thoroughly, and retain it for future reference.

### Owner's Record

The model and serial numbers are located on the bottom. Record the serial number in the space provided below. Refer to these numbers whenever you call upon your Sony dealer regarding this product.

Model No. DSC-U60

Serial No. \_\_\_\_\_

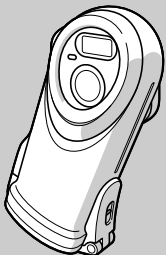

Cyber-shot U



### DSC-U60

© 2003 Sony Corporation

3-078-724-11(1)

Getting started \_\_\_\_\_

Shooting still images \_\_\_\_\_

Viewing still images \_\_\_\_\_

Enjoying movies \_\_\_\_\_

Deleting images \_\_\_\_\_

Enjoying images on your computer \_\_\_\_\_

Troubleshooting \_\_\_\_\_

Additional information \_\_\_\_\_

Index \_\_\_\_\_

## WARNING

### On the battery charger

To prevent fire or shock hazard, do not expose the unit to rain or moisture.

### For the Customers in the U.S.A.

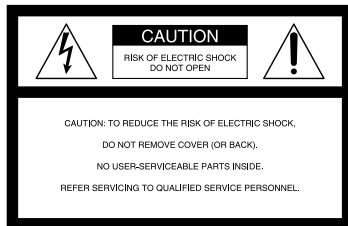

This symbol is intended to alert the user to the presence of uninsulated “dangerous voltage” within the product’s enclosure that may be of sufficient magnitude to constitute a risk of electric shock to persons.



This symbol is intended to alert the user to the presence of important operating and maintenance (servicing) instructions in the literature accompanying the appliance.

If you have any questions about this product, you may call:

Sony Customer Information Services Center  
1-800-222-SONY (7669)

The number below is for the FCC related matters only.

### Regulatory Information

#### Declaration of Conformity

Trade Name: SONY  
Model No.: DSC-U60  
Responsible Party: Sony Electronics Inc.  
Address: 680 Kinderkamack  
Road, Oradell, NJ 07649  
U.S.A.

Telephone No.: 201-930-6972

This device complies with Part 15 of the FCC Rules. Operation is subject to the following two conditions: (1) This device may not cause harmful interference, and (2) this device must accept any interference received, including interference that may cause undesired operation.

#### CAUTION

You are cautioned that any changes or modifications not expressly approved in this manual could void your authority to operate this equipment.

#### Note:

This equipment has been tested and found to comply with the limits for a Class B digital device, pursuant to Part 15 of the FCC Rules. These limits are designed to provide reasonable protection against harmful interference in a residential installation. This equipment generates, uses, and can radiate radio frequency energy and, if not installed and used in accordance with the instructions, may cause harmful interference to radio communications. However, there is no guarantee that interference will not occur in a particular installation. If this equipment does cause harmful interference to radio or television reception, which can be determined by turning the equipment off and on, the user is encouraged to try to correct the interference by one or more of the following measures:

- Reorient or relocate the receiving antenna.
- Increase the separation between the equipment and receiver.
- Connect the equipment into an outlet on a circuit different from that to which the receiver is connected.
- Consult the dealer or an experienced radio/TV technician for help.

The supplied interface cable must be used with the equipment in order to comply with the limits for a digital device pursuant to Subpart B of Part 15 of FCC Rules.

## For the Customers in the U.S.A. and Canada

### RECYCLING NICKEL METAL HYDRIDE BATTERIES

Nickel Metal Hydride batteries are recyclable. You can help preserve our environment by returning your used rechargeable batteries to the collection and recycling location nearest you.



For more information regarding recycling of rechargeable batteries, call toll free 1-800-822-8837, or visit <http://www.rbrc.org/>

#### CAUTION:



Do not handle damaged or leaking Nickel Metal Hydride batteries.

#### CAUTION

TO PREVENT ELECTRIC SHOCK, MATCH WIDE BLADE OF PLUG TO WIDE SLOT, FULLY INSERT.

## Notice for the customers in the United Kingdom

A moulded plug complying with BS1363 is fitted to this equipment for your safety and convenience.

Should the fuse in the plug supplied need to be replaced, a fuse of the same rating as the supplied one and approved by ASTA or BSI to BS1362, (i.e., marked with  or  mark) must be used. If the plug supplied with this equipment has a detachable fuse cover, be sure to attach the fuse cover after you change the fuse. Never use the plug without the fuse cover. If you should lose the fuse cover, please contact your nearest Sony service station.

## Attention for the Customers in Europe

This product has been tested and found compliant with the limits sets out in the EMC Directive for using connection cables shorter than 3 meters (9.8 feet).

#### Attention

The electromagnetic fields at the specific frequencies may influence the picture of this camera.

## Notice

If static electricity or electromagnetism causes data transfer to discontinue midway (fail), restart the application or disconnect and connect the USB cable again.

Certain countries may regulate disposal of the battery used to power this product. Please consult with your local authority.

## “Memory Stick”



## For the Customers in the U.S.A. and Canada

THIS DEVICE COMPLIES WITH PART 15 OF THE FCC RULES. OPERATION IS SUBJECT TO THE FOLLOWING TWO CONDITIONS:

- (1) THIS DEVICE MAY NOT CAUSE HARMFUL INTERFERENCE, AND
- (2) THIS DEVICE MUST ACCEPT ANY INTERFERENCE RECEIVED, INCLUDING INTERFERENCE THAT MAY CAUSE UNDESIRE OPERATION.

THIS CLASS B DIGITAL APPARATUS COMPLIES WITH CANADIAN ICES-003.

## Before using your camera

### Notes on waterproof performance

- This camera conforms to IEC60529 IPX6\* and IPX7\*\*, and can be used in places exposed to splashing water or underwater up to depths of 1.5 m (5 feet).
- \* Water shall not enter the interior even when exposed to direct jet streams of water (normal temperature fresh water) from any direction.
- \*\* Water shall not seep into the interior even when left submerged in normal temperature fresh water at a depth of 1 m (3 feet 3 1/4 inches) in a stationary condition for approximately 30 minutes.
- You can use this camera in the following places: underwater (ocean, swimming pools) up to depths of 1.5 m (5 feet), beachside, riverside, poolside, ski slopes, in the rain, etc.
- Do not use this camera in the following places: places where the camera might be subject to high water pressure, hot springs or bathtubs, etc.

### Notes on use

- Before using this camera underwater or in places exposed to water, be sure to inspect the O-ring and the O-ring mating surface on the inside of the camera.
- Do not immerse the camera in water containing soap, detergent, bath salts, etc., or in hot water with a temperature of more than 30°C.
- Never open the waterproof cover underwater or in places exposed to water. Lock the lock switch to prevent the waterproof cover from opening by accident.

- This camera does not float in water.
- Before opening the waterproof cover, be sure to rinse off any sand and completely wipe away any water that may be present on the camera body.
- Should you find any evidence of water leaks inside the waterproof cover, stop using the camera at once and contact your Sony dealer or local authorized Sony service facility.
- Sony cannot be held responsible for malfunctions or irreparable problems arising from water or foreign objects entering the inside of the camera due to improper handling.
- Note that waterproof performance is not guaranteed under all environments and conditions.

### Trial recording

Before you record one-time events, you may want to make a trial recording to make sure that the camera is working correctly.

### No compensation for contents of the recording

Contents of the recording cannot be compensated for if recording or playback is not possible due to a malfunction of your camera or recording media, etc.

### Back up recommendation

To avoid the potential risk of data loss, always copy (back up) data to a disk.

### Notes on image data compatibility

- This camera conforms with the Design rule for Camera File system universal standard established by the JEITA (Japan Electronics and Information Technology Industries Association).
- Playback of images recorded with your camera on other equipment and playback of images recorded or edited with other equipment on your camera are not guaranteed.

### Note on “Memory Stick”

This camera turns off when you open the inner cover. Do not open the inner cover while the access lamp is lit.

### Precaution on copyright

Television programs, films, video tapes, and other materials may be copyrighted. Unauthorized recording of such materials may be contrary to the provision of the copyright laws.

### Do not shake or strike the camera

In addition to malfunctions and inability to record images, this may render the “Memory Stick” unusable or image data breakdown, damage or loss may occur.

### LCD screen, LCD finder (only models with an LCD finder) and lens

- The LCD screen and the LCD finder are manufactured using extremely high-precision technology so over 99.99% of the pixels are operational for effective use. However, there may be some tiny black points and/or bright points (white, red, blue or green in color) that constantly appear on the LCD screen and the LCD finder. These points are normal in the manufacturing process and do not affect the recording in any way.
- Be careful when placing the camera near a window or outdoors. Exposing the LCD screen, the LCD finder or the lens to direct sunlight for long periods may cause malfunctions.
- Do not press the LCD screen hard. The screen may be uneven and that may cause a malfunction.
- Images may be trailed on the LCD screen in a cold location. This is not a malfunction.

### Clean the flash surface before use

The heat of flash emission may cause dirt on the flash surface to become discolored or to stick to the flash surface, resulting in insufficient light emission.

### On humidity and moisture condensation

If moisture condensation occurs, see page 75 and follow the instructions on how to remove it before using the camera.

### Note on the camera locations

Do not use the camera near a location that generates strong radio wave or emits radiation. The camera may not be able to record or play back properly.

### The pictures used in this manual

The photographs used as examples of pictures in this manual are reproduced images, and are not actual images shot using this camera.

### Trademarks

- “Memory Stick,”  and “MagicGate Memory Stick” are trademarks of Sony Corporation.
- “Memory Stick Duo” and **MEMORY STICK DUO** are trademarks of Sony Corporation.
- “Memory Stick PRO” and **MEMORY STICK PRO** are trademarks of Sony Corporation.
- “MagicGate” and **MAGIC GATE** are trademarks of Sony Corporation.
- Microsoft and Windows are registered trademarks of the U.S. Microsoft Corporation in the United States and other countries.
- Macintosh, Mac OS, iBook and Power Mac are trademarks or registered trademarks of Apple Computer, Inc.
- Pentium is a trademark or a registered trademark of Intel Corporation.
- In addition, system and product names used in this manual are, in general, trademarks or registered trademarks of their respective developers or manufacturers. However, the <sup>TM</sup> or ® marks are not used in all cases in this manual.

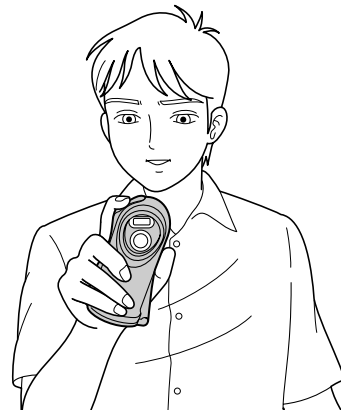

When shooting an image with the camera, be careful not to obstruct the flash or the lens with your fingers.

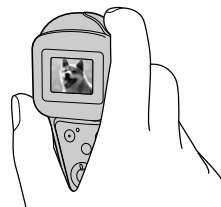

Check the LCD screen to make sure the image is level.

# Table of contents

Before using your camera .....	4
How to hold the camera .....	5
Identifying the parts .....	8

## Getting started

Preparing batteries .....	10
Charging the batteries .....	10
Inserting the batteries .....	12
Using your camera abroad .....	15
Turning on/off your camera .....	15
How to use the buttons .....	16
Setting the date and time .....	16

## Shooting still images

Inserting and removing a “Memory Stick” .....	18
Setting the still image size .....	20
Image size .....	21
Basic still image shooting	
— Using auto adjustment mode .....	22
Using the self-timer .....	24
Selecting a flash mode .....	25
Creating or selecting a folder .....	26
Creating a new folder .....	27
Selecting the recording folder .....	28
Shooting according to scene conditions	
— Scene Selection .....	30
Setting the distance to the subject	
— Focus preset .....	32

Shooting five images continuously	
— Burst .....	33
Adding special effects	
— Picture Effect .....	34

## Viewing still images

Viewing still images on the LCD	
screen .....	36
Viewing single images .....	36
Viewing an index screen (four-image) .....	37
Selecting the folder and playing back images — Folder .....	38
Enlarging an image	
— Enlarged playback .....	40
Choosing images to print	
— Print (DPOF) mark .....	41

## Enjoying movies

Shooting movies .....	43
Viewing movies on the LCD screen .....	44

## Deleting images

Deleting images .....	46
Formatting a “Memory Stick” .....	47

## Enjoying images on your computer

Copying images to your computer	
— For Windows users .....	49
Installing the USB driver .....	50
Installing “Image Transfer” .....	51
Installing “ImageMixer” .....	52
Connecting the camera to your computer .....	53
Copying images using “Image Transfer” .....	54
Changing “Image Transfer” settings .....	55
Copying images without using “Image Transfer” .....	55
Viewing images on your computer .....	56
Image file storage destinations and file names .....	57
Copying images to your computer	
— For Macintosh users .....	58
Creating a Video CD using “ImageMixer” .....	60

## Troubleshooting

Troubleshooting .....	61
Warnings and messages .....	68
Self-diagnosis display	
— If a code starting with an alphabet letter appears .....	70

## Additional information

Menu items .....	71
Precautions .....	74
On “Memory Stick” .....	76
On Nickel-Metal Hydride batteries .....	78
On the battery charger .....	79
On the O-ring .....	79
Specifications .....	82
LCD screen displays .....	83

## Index

Index .....	85
-------------	----

## Identifying the parts

See the pages in parentheses for details of operation.

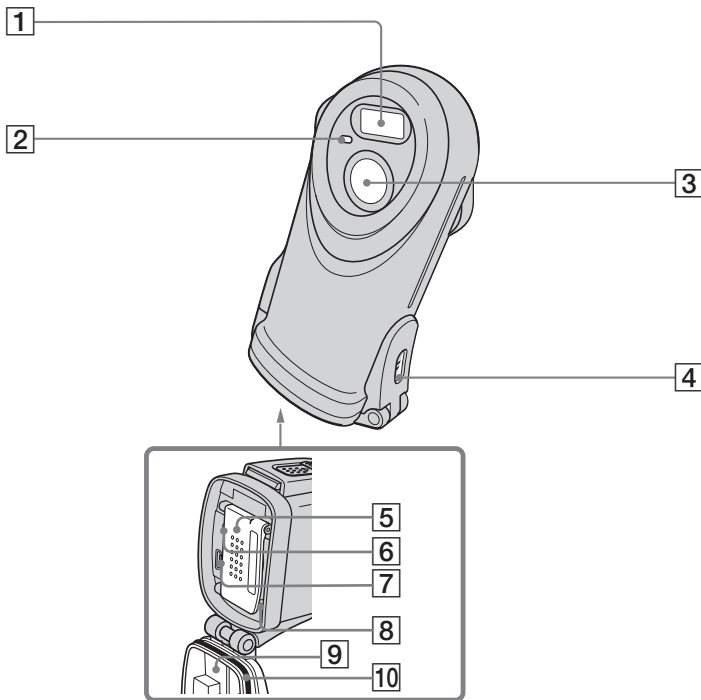

- 1 Flash (25)
- 2 Self-timer lamp (25)
- 3 Lens
- 4 Hook for hand strap
- 5 Inner cover
- 6 RESET button (61)
- 7  $\psi$  (USB) jack (53)
- 8 Access lamp (19)
- 9 Waterproof cover
- 10 O-ring (79)

### Attaching the hand strap

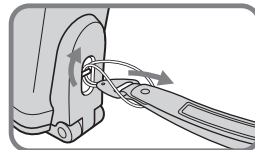

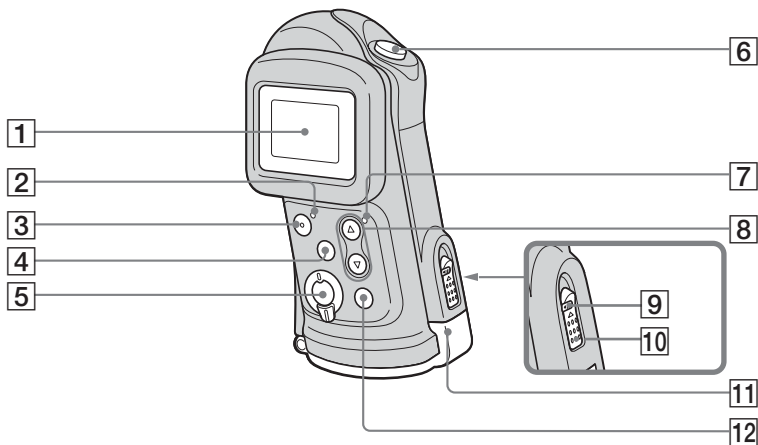

- 1** LCD screen
  - 2** POWER lamp (15)
  - 3** POWER button (15)
  - 4** MENU button (16)
  - 5** Mode switch
    - : To view images (36)
    - : To shoot still images (22)
    - To shoot five images continuously (33)
    - : To shoot movies (43)
  - 6** Shutter button (22)
  - 7** ⚡ (Flash charge) lamp (orange) (26)
  - 8** Control buttons
    - Menu on: ▲/▼ (16)
    - Menu off: ⚡/SCENE (25, 30)
  - 9** Lock switch (12)
  - 10** OPEN button (12)
  - 11** Slide lock lever (12)
  - 12** EXEC button (16)
- When viewing images:**  
**Q** (Enlarged playback) (40)

## Preparing batteries

Use the following batteries in this camera.

### Acceptable batteries

HR11/45: HR03 (size AAA) Nickel-Metal Hydride batteries (2)

- NH-AAA-DA (2) (supplied)
- NH-AAA-2DA twin-pack (not supplied)

### Batteries that cannot be used

Manganese batteries, lithium batteries, Ni-Cd batteries, alkaline batteries

- When the above batteries are used, operation is not guaranteed due to possible voltage drops or other characteristics of the batteries.

In addition, the battery remaining indicator is not displayed correctly.

## Charging the batteries

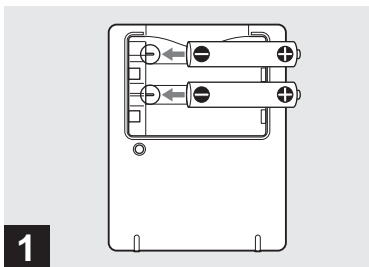

- 1** → Insert Nickel-Metal Hydride batteries into the battery charger (supplied) with the correct polarity +/-.

- You cannot use any battery other than a Nickel-Metal Hydride battery. Also, operations are not guaranteed when using a Nickel-Metal Hydride battery from a manufacturer other than Sony.
- Be sure to charge the Nickel-Metal Hydride batteries supplied with your camera before using them for the first time.
- Connect the battery charger to an easily accessible wall outlet (wall socket) close by.
- Even if the CHARGE lamp is not lit, the battery charger is not disconnected from the AC power source (mains) as long as it is connected to the wall outlet (wall socket). If some trouble occurs while using the battery charger, immediately shut off the power by disconnecting the plug from the wall outlet (wall socket).

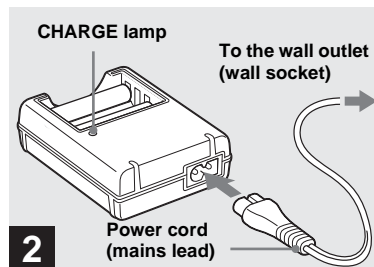

- 2** → Connect the battery charger to a wall outlet (wall socket) using the power cord (mains lead).

The CHARGE lamp lights up when charging begins, and goes off when charging is completed.

For details on the supplied battery charger, see page 79.

- When charging is finished, disconnect the power cord (mains lead) from the wall outlet (wall socket), and remove the Nickel-Metal Hydride batteries from the battery charger.

## Charging time

Nickel-Metal Hydride battery	Charging time
NH-AAA-DA × 2 (supplied)	Approx. 6 hours

This represents the time required to charge fully depleted Nickel-Metal Hydride batteries using the supplied battery charger in an environment where the ambient temperature is 25°C (77°F).

- It takes about six hours to completely charge the batteries. The CHARGE lamp may remain lit longer than six hours, but this is not a malfunction.
- If you use the BC-CSQ2 battery charger supplied with the STAMINA “Super Quick charge” kit (not supplied), the batteries will charge faster.

Charging time for Size AAA Nickel-Metal Hydride batteries

2 batteries: Approx. 1 hour 25 minutes

4 batteries: Approx. 2 hours 50 minutes

## Notes on the Nickel-Metal Hydride batteries

- If the poles of the Nickel-Metal Hydride batteries are dirty, the batteries may not charge properly. Occasionally clean the poles of the batteries and the terminals of the charger by wiping them with a dry cloth.
- Always use the supplied case when transporting the Nickel-Metal Hydride batteries. If the positive and negative terminals come into contact with metallic material and are shorted, the batteries could overheat or catch fire.
- At the time of purchase, or when the Nickel-Metal Hydride batteries have not been used for a long time, they may not fully charge. This is typical of this type of battery, and is not a malfunction. If this happens, repeatedly using up the batteries fully, and then charging them, should correct the problem.
- Even when Nickel-Metal Hydride batteries are not being used they lose their charge naturally over time. It is recommended that you recharge the batteries just before using them.
- If you recharge Nickel-Metal Hydride batteries before fully using up the existing charge, the low battery warning may be displayed sooner than expected. This is called the “memory effect.”\* If this problem occurs, charging the batteries only after using up the existing charge will correct it.

\* The “memory effect” – the situation in which the capacity of the battery is temporarily lowered.

- Do not peel off the external seals or damage the batteries. Never use batteries from which the seals have been partially or completely removed, or batteries that have been split in any way. These may cause leakage, explosion, or heat-up of the battery, and personal scald or injury may be caused. These may cause a malfunction of the battery charger.

## Inserting the batteries

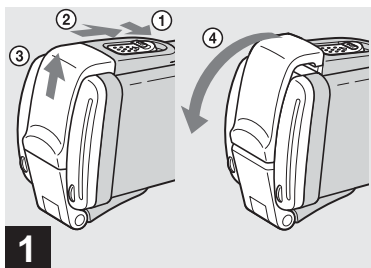

- ➔ **Slide the lock switch and the OPEN button in the direction of the arrow and open the waterproof cover.**

The waterproof cover opens toward you.

- **Before opening the waterproof cover, be sure to rinse off any sand and completely wipe away any water that may be present on the camera body.**
- Never open the waterproof cover underwater or in places exposed to water, as this may allow water to enter the inside of the camera and cause a malfunction.
- Immediately after the camera is brought from a warm place to a cold place such as from indoors to outdoors, the difference in pressure between the inside of the camera and the outside air may make it difficult to open the waterproof cover.

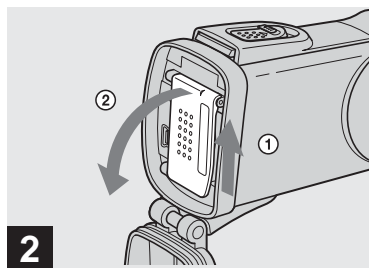

- ➔ **Slide the inner cover in the direction of the arrow to open it.**

The inner cover opens toward you when you slide it in the direction of the arrow.

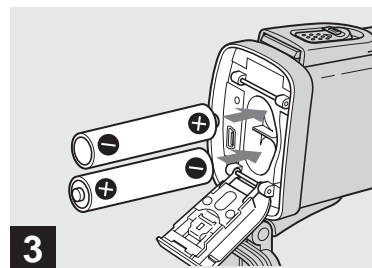

- ➔ **Insert the batteries.**

Match the +/- poles of the batteries to the +/- marks inside the battery case.

- From time to time, use a dry cloth to wipe any dirt off of the battery terminals and the contacts inside the inner cover. Skin oil and other dirt on the battery terminals and contacts can significantly shorten the operating time provided by the batteries.

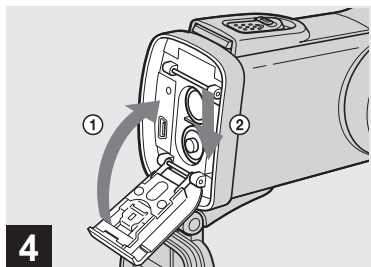

- 4** → Close the inner cover and slide it in the direction of the arrow to lock it.

Close the inner cover while holding the batteries in. Make sure the cover is closed securely.

#### To remove the batteries

Perform steps **1** and **2** and remove the batteries.

- Be careful not to drop the batteries when opening or closing the inner cover.

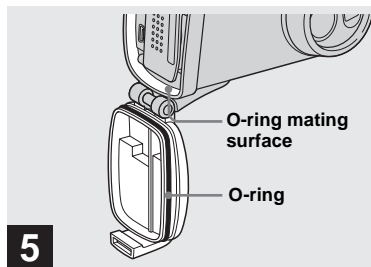

- 5** → Inspect the waterproof cover.

Inspect the O-ring and the O-ring mating surface for scratches, deformation, dirt, hair or other problems.

- Note that if the O-ring and the O-ring mating surface are damaged, dirty or have other problems, the waterproof performance may be impaired. In this case, water may enter the inside of the camera and cause irreparable damage.
- Replace the O-ring with a new one if it becomes scratched or deformed, or after approximately two years of use even if there are no problems (page 81).

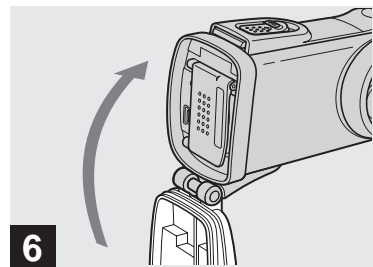





- 6** → Close the waterproof cover.

Close the waterproof cover and slide the slide lock lever back into place until the OPEN button clicks.

- When using the camera underwater or in places exposed to water, slide the lock switch (page 9) to lock the waterproof cover. This prevents the waterproof cover from opening by accident.

## Battery remaining indicator (When using Nickel-Metal Hydride batteries)

As the battery power decreases with use, the battery remaining indicator displays the amount of power remaining using the following symbols.

Battery remaining indicator	Battery remaining guidelines
	Sufficient power remaining
	Battery half full
	Battery low, recording/ playback will stop soon.
	Change the batteries for fully charged ones, or charge these batteries. (The warning indicator flashes.)

- If the LCD screen display is off, set [DISPLAY] in [ ] to [ON].
- Based on the conditions under which the camera is being used and the state of the charge, or on the environment, this information may not be correctly indicated.
- The battery remaining indicator is not displayed in USB connecting.

## Battery life and number of images that can be recorded/ viewed

The tables show the approximate battery life and the number of images that can be recorded/viewed with fully charged batteries at a temperature of 25°C (77°F) in auto adjustment mode. The numbers of images that can be recorded/viewed take into account changing the supplied “Memory Stick” as necessary. Note that the actual numbers may be less than indicated depending on the conditions of use.

### Shooting still images Under the average conditions<sup>1)</sup>

Image size	NH-AAA-DA (2) (supplied)		
	LCD LIGHT	No. of images	Battery life (min.)
2.0M	ON	Approx. 140	Approx. 70
	OFF	Approx. 160	Approx. 80
VGA	ON	Approx. 140	Approx. 70
	OFF	Approx. 160	Approx. 80

- 1) Shooting in the following situations:
- Shooting one time every 30 seconds
  - The flash strobes once every two times
  - The power turns on and off once every ten times.

## Viewing still images<sup>2)</sup>

Image size	NH-AAA-DA (2) (supplied)	
	No. of images	Battery life (min.)
2.0M	Approx. 3000	Approx. 150
VGA	Approx. 3000	Approx. 150

- 2) Viewing single images in order at about 3-second intervals with [LCD LIGHT] set to [ON]

## Shooting movies<sup>3)</sup>

NH-AAA-DA (2) (supplied)		
Continuous recording	LCD LIGHT	Battery life (min.)
		ON
	OFF	Approx. 90

- 3) The maximum shooting time is 15 seconds.

- The remaining indicator will decrease in the following situations:
  - The surrounding temperature is low
  - The flash is used
  - The camera has been turned on and off many times
  - [LCD LIGHT] is set to [ON]
  - The battery capacity decreases as you use it more and more and as time passes (page 78).

## Using your camera abroad

### Power sources

You can use your camera in any country or region with the supplied battery charger within 100 V to 240 V AC, 50/60 Hz. Use a commercially available AC plug adaptor [a], if necessary, depending on the design of the wall outlet (wall socket) [b].

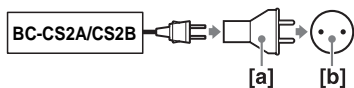

- Do not use an electronic transformer (travel converter), as this may cause a malfunction.

## Turning on/off your camera

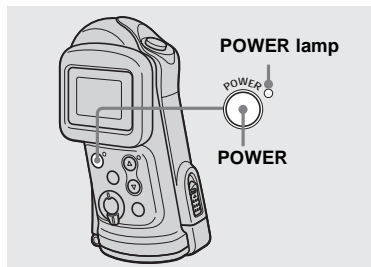

➔ **Press POWER to turn on the power.**

The POWER lamp (green) lights up and the power is on. When you turn on your camera for the first time, the DATE NOTATION screen appears on the LCD screen (page 16).

### To turn off the power

Press POWER again. The POWER lamp goes out, and the camera turns off.

### Auto power-off function

If you do not operate the camera for about three minutes, the camera turns off automatically to prevent wearing down the batteries.

However, the auto power-off function will not operate when the camera is connected to a computer with the USB cable.

## How to use the buttons

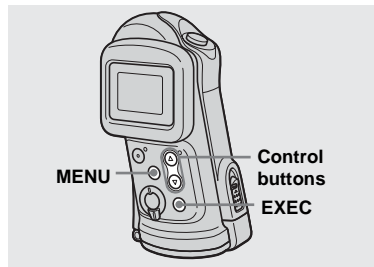

To change the current settings of the camera, bring up the menu, and use the control buttons to make the changes.

For each item, press MENU to display the menu and press the control buttons ▲/▼ to select the desired value, then press EXEC to make the setting.

Press MENU, then the menu disappears from the LCD screen.

## Setting the date and time

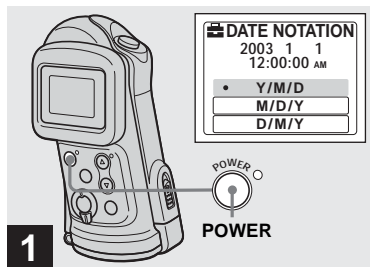

➔ Press POWER to turn on the power.

The POWER lamp (green) lights up and the DATE NOTATION screen appears on the LCD screen.

- To change the date and time, press MENU and select [DATE&TIME SET] in [CLOCK SET] under [ ] (page 73), then perform step 3. When the setting is complete, press MENU so that the CLOCK SET screen disappears from the LCD screen.
- This operation is available no matter what position the mode switch is in.

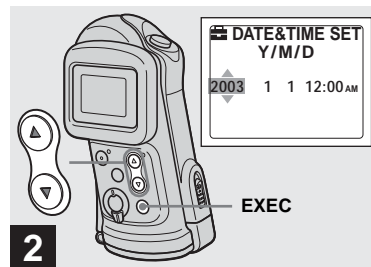

➔ Select the desired date display format with the control buttons ▲/▼, then press EXEC.

Select from [Y/M/D] (year/month/day), [M/D/Y] (month/day/year) or [D/M/Y] (day/month/year). Then DATE&TIME SET screen appears on the LCD screen.

- If the rechargeable button battery, which provides the power for saving the time data, is ever fully discharged (page 76), the DATE NOTATION screen will appear again. When this happens, reset the date and time, by starting from step 2.

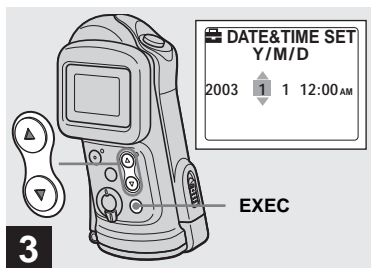

➔ Set the numeric value with the control buttons ▲/▼, then press EXEC.

The item to be set is indicated with ▲/▼. After entering the number, ▲/▼ moves to the next item. Repeat this step until all of the items are set.

- If you selected [D/M/Y] in step 2, set the time on a 24-hour cycle.

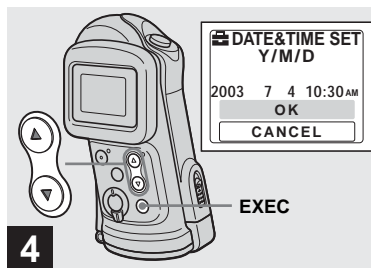

➔ Select [OK] with the control button ▲, then press EXEC.

The date and time are entered and the clock starts to keep time.

- If you make a mistake, select [CANCEL] in step 4 to display the DATE NOTATION screen, then repeat the procedure from step 2.
- To cancel the date and time setting, select [CANCEL], then press EXEC.

## Inserting and removing a "Memory Stick"

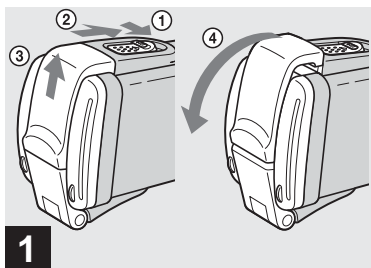

- ➔ Slide the lock switch and the OPEN button in the direction of the arrow and open the waterproof cover.**

The waterproof cover opens toward you.

- Before opening the waterproof cover, be sure to rinse off any sand and completely wipe away any water that may be present on the camera body.
- Never open the waterproof cover underwater or in places exposed to water, as this may allow water to enter the inside of the camera and cause a malfunction.
- Immediately after the camera is brought from a warm place to a cold place such as from indoors to outdoors, the difference in pressure between the inside of the camera and the outside air may make it difficult to open the waterproof cover.

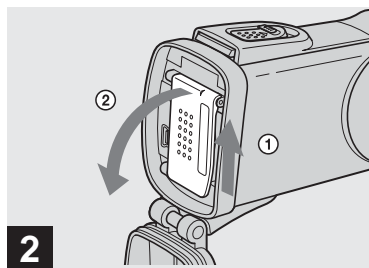

- ➔ Slide the inner cover in the direction of the arrow to open it.**

The inner cover opens toward you when you slide it in the direction of the arrow.

- For details on the "Memory Stick," see page 76.

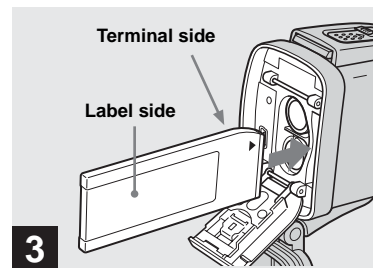

- ➔ Insert the "Memory Stick."**

Holding the "Memory Stick" as shown in the illustration, insert it all the way in until it clicks.

- Push the "Memory Stick" all of the way in so that it is securely seated in the connector. If the "Memory Stick" is not inserted correctly, you may not be able to record or display images in the "Memory Stick."
- Be careful not to drop the batteries when opening or closing the inner cover.

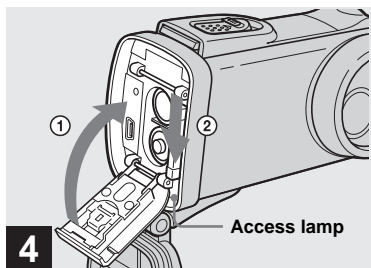

**4** → Close the inner cover and slide it in the direction of the arrow to lock it.

Make sure the cover is closed securely.

#### To remove a “Memory Stick”

Perform steps **1** and **2**, and push the “Memory Stick” to pop it out. When doing so, be careful not to drop the “Memory Stick.”

- When the access lamp is lit up, it means that image data is being read or written. Never open the inner cover or turn off the power at this time, as the data may be damaged.

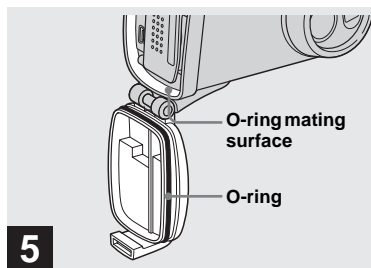

**5** → Inspect the waterproof cover.

Inspect the O-ring and the O-ring mating surface for scratches, deformation, dirt, hair or other problems.

- Note that if the O-ring and the O-ring mating surface are damaged, dirty or have other problems, the waterproof performance may be impaired. In this case, water may enter the inside of the camera and cause irreparable damage.
- Replace the O-ring with a new one if it becomes scratched or deformed, or after approximately two years of use even if there are no problems (page 81).

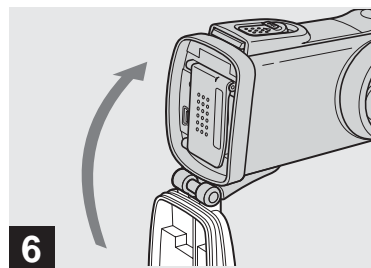



**6** → Close the waterproof cover.

Close the waterproof cover and slide the slide lock lever back into place until the OPEN button clicks.

- When using the camera underwater or in places exposed to water, slide the lock switch (page 9) to lock the waterproof cover. This prevents the waterproof cover from opening by accident.

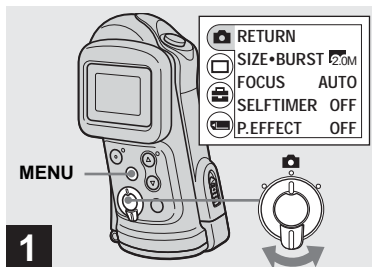



## Setting the still image size

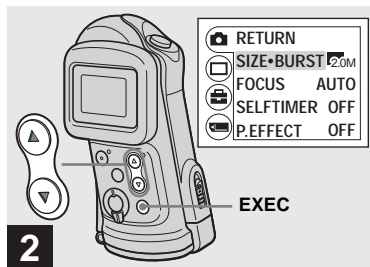

- ➔ Set the mode switch to , and turn on the power, then press MENU.

The menu appears on the LCD screen.





- ➔ Select [] with the control button , then press EXEC. Select [SIZE-BURST] with the control buttons /, then press EXEC.

The image size is displayed.

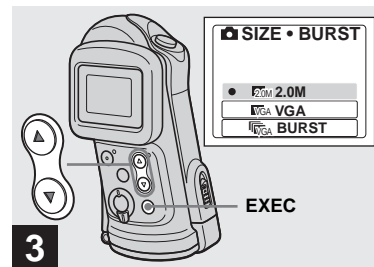
- For details on the image size, see page 21.



- ➔ Select the desired image size with the control buttons /, then press EXEC.

The image size is set.

When the setting is complete, press MENU so that the menu disappears from the LCD screen.

- The image size selected here is maintained even when the power is turned off.

## Image size

You can choose the image size (number of pixels) according to the kind of images you want to shoot. The larger you make the image size, the better your image, but also the larger the amount of data needed to preserve your image. This means you can save fewer images in your “Memory Stick.” Choose an image size appropriate for the kind of images you want to shoot.

You can choose from the following table. The below image size is a minimum setting for examples.

Image size	Examples
2.0M	1632×1224 Printing A5 size images
VGA	640×480 Creating home pages

## Number of images that can be saved in a “Memory Stick”

(Units: number of images)

Capacity Image size	8MB	16MB	32MB	64MB	128MB	MSX-256	MSX-512	MSX-1G
2.0M	14	29	60	122	245	445	906	1851
VGA	80	161	326	656	1316	2380	4840	9880

- When the images recorded using earlier Sony models are played back, the image size indication may be different from the actual image size.
- Images viewed on the LCD screen of the camera all appear the same size.
- The actual number of images may differ depending on the shooting conditions.
- When the number of remaining shooting images is greater than 9999, >9999 indicator appears on the LCD screen.

## Basic still image shooting — Using auto adjustment mode

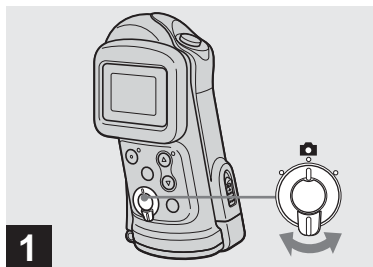

➔ **Set the mode switch to , and turn on the power.**

The name of the folder where the image will be recorded appears on the LCD screen for approximately five seconds.

- [FOCUS] is set to [AUTO] at the factory.
- The exposure is automatically adjusted.
- This camera can create new folders and select folders to be stored in the “Memory Stick” (page 26).

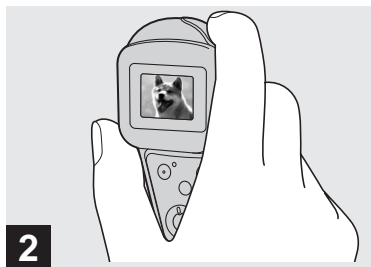

➔ **Hold the camera steadily with a hand and position the subject in the center of the LCD screen.**

Do not cover the lens or flash with your fingers.

- Check the LCD screen to make sure the image is level.
- When recording outdoors during clear weather or under other intense light, undesired light (ghosting) may enter the screen. If this happens, shade the lens with your hand or other object while recording.
- The exposure and focus are adjusted to the center of the LCD screen.

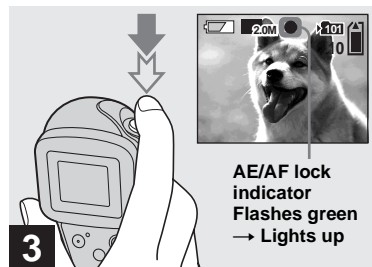

➔ **Press and hold the shutter button halfway down.**

A beep sounds. When the AE/AF lock indicator changes from flashing to lighted up, the camera is ready for shooting.

- If you release the shutter button, the recording will be canceled.
- When the camera does not beep, the AF adjustment is not complete. You can continue to shoot, but the focus is not adjusted properly.
- This camera employs an auto-macro AF function. The minimum focal distance to the subject is 10 cm (4 inches) (or 15 cm (6 inches) underwater).



4

#### ➔ Press the shutter button fully down.

A beep sounds. When “RECORDING” disappears from the LCD screen, recording is complete. The image will be recorded in the “Memory Stick,” and you can shoot the next image.

- If you do not operate the camera for about three minutes during recording or playback, the camera turns off automatically to prevent wearing down the batteries (page 15).

## Auto Focus

When you try to shoot a subject that is difficult to focus on, the AE/AF lock indicator changes to flashing slowly. The Auto Focus function may have difficulty working under the following conditions. In such cases, release the shutter button, then recompose the shot and focus again. If the Auto Focus function can still not bring the subject into focus, use the Focus preset function (page 32).

- The subject is distant from the camera and dark.
- The contrast between the subject and its background is poor.
- The subject is seen through glass, such as a window.
- A fast-moving subject.
- The subject reflects or has a lustrous finish, such as a mirror or a luminous body.
- A flashing subject.
- A backlit subject.

## LCD light

You can use [LCD LIGHT] under [ ] with MENU and the control buttons ▲/▼ to turn the LCD light on and off. This is useful for extending the battery life.

- This camera is equipped with a Hybrid-type LCD screen that allows you to see the LCD screen even when the LCD light is turned off, as long as there is some ambient illumination.
- Even if the LCD light setting is [OFF], the LCD light will turn on when menu operations are being performed. When the menu operation is completed, the LCD light will turn off again.

## LCD screen display during shooting

You can use [DISPLAY] under [ ] with MENU and the control buttons ▲/▼ to turn the display on and off. This is useful when recording under conditions where it is difficult to check the image on the LCD screen.

When [DISPLAY] is [ON]

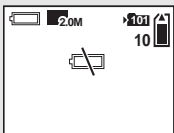

When [DISPLAY] is [OFF]

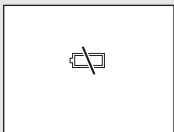

- For detailed descriptions of the indicators, see page 83.
- Indicators on the LCD screen are not recorded.

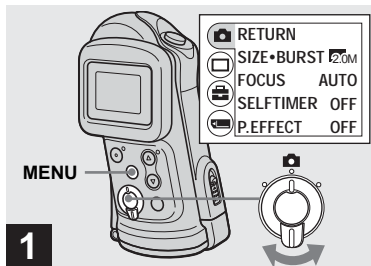



➔ Set the mode switch to , and press MENU.

The menu appears on the LCD screen.

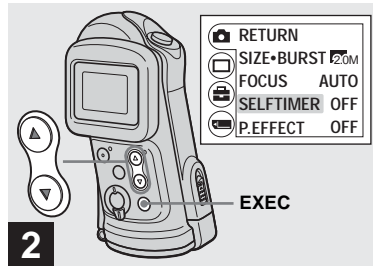
- You can also carry out this operation when the mode switch is set to .



➔ Select  with the control button ▲, then press EXEC. Select [SELFTIMER] with the control buttons ▲/▼, then press EXEC.

- When the mode switch is set to , select [ ] with the control button ▲.

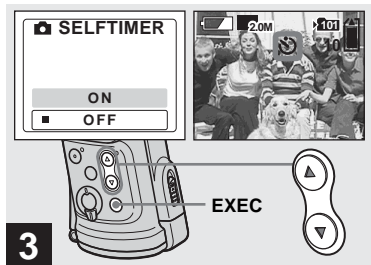

➔ **Select [ON] with the control button ▲, then press EXEC.**

When you press MENU, the menu disappears and the  (self-timer) indicator appears on the LCD screen.

- When placing the camera in a standing position, make sure the LCD screen is level.

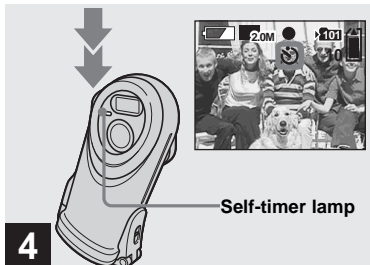

➔ **Center the subject in the LCD screen and press the shutter button fully down.**

The self-timer lamp flashes red and a continuous beep sounds. The image will be shot after approximately 10 seconds.

**To cancel the self-timer in the middle of the operation**

Press POWER to turn off the power.

- If you press the shutter button while standing in front of the camera, the focus and the exposure may not be correctly set.





➔ **Set the mode switch to , and press the control button ▲ (⚡) repeatedly to select a flash mode.**





Each time you press ▲ (⚡), the indicator changes as follows.

**No indicator (Auto):** Based on the lighting conditions, the camera will decide if there is enough light, and will use the flash accordingly.

 **(Red-eye reduction):** Flash mode is set to Auto, and the red-eye reduction operates if the flash strobes.

 **(Forced flash):** The flash strobes regardless of the surrounding brightness.

 **(No flash):** The flash does not strobe.

- You cannot use the flash in the Burst mode.
- If the menu is currently displayed, press MENU first so that the menu disappears.
- The recommended shooting distance using the flash is approximately 0.5 m to 1.9 m (1 foot 7 3/4 inches to 6 feet 2 3/4 inches).
- When using the Auto,  (Red-eye reduction) or  (Forced flash) mode, you may notice some noise in the image when you look at the LCD screen in a dark place, but this will have no effect on the shot image.
- When using the  (No flash) mode, the shutter speed becomes slower in dark places, so using a tripod is recommended.
- While charging the flash, the  (Flash charge) lamp flashes. After the charging is complete, the lamp goes out.
- This setting is maintained even when the power is turned off.

## Red-eye reduction

The flash pre-strobes before shooting to reduce the red-eye phenomenon.

The  indicator appears on the LCD screen.



- Red-eye reduction may not produce the desired effects depending on individual differences, the distance to the subject, if the subject does not see the pre-strobe, or other conditions.

## Creating or selecting a folder

Your camera can create multiple folders in a “Memory Stick.” Also, you can select the folder used to store images.

When not creating a new folder, “101MSDCF” folder is selected as the recording folder.

You can create folders up to “999MSDCF.”

- Up to 4000 images can be stored in one folder. When the folder capacity is exceeded, a new folder is automatically created.

## Creating a new folder

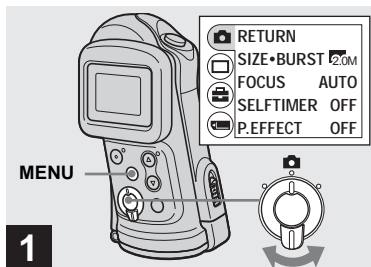



➔ Set the mode switch to , then press MENU.

The menu appears on the LCD screen.

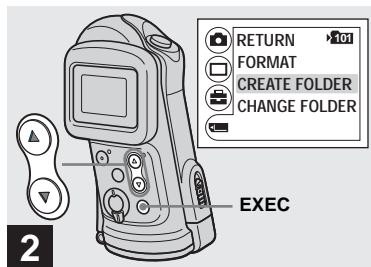
- You can also carry out this operation when the mode switch is set to .



➔ Select [RETURN] with the control button , then press EXEC. Select [CREATE FOLDER] with the control buttons /, then press EXEC.

The CREATE REC. FOLDER screen appears.

- Once you create a new folder, you cannot delete the new folder with the camera.
- Images are recorded in the newly created folder until a different folder is created or selected.

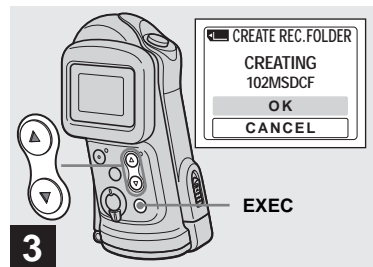



➔ Select [OK] with the control button , then press EXEC.

A new folder is created with a number one higher than the largest number in the “Memory Stick,” and the folder becomes the recording folder. When you press MENU, the menu disappears and the created folder is displayed.

**To cancel folder creation**  
Select [CANCEL] in step **3**.

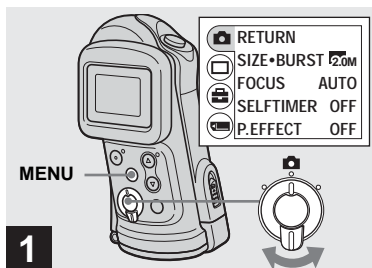
## Selecting the recording folder





- ➔ Set the mode switch to , then press MENU.

The menu appears on the LCD screen.

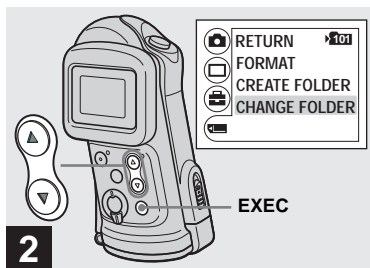

- You can also carry out this operation when the mode switch is set to .

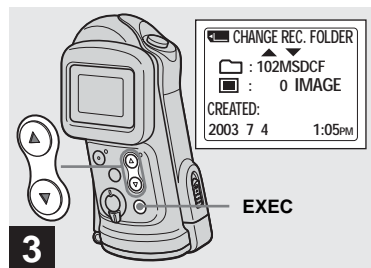

- ➔ Select [CHANGE FOLDER] with the control button , then press EXEC. Select [CHANGE FOLDER] with the control button , then press EXEC.

The CHANGE REC. FOLDER screen appears.



- ➔ Select the desired folder with the control buttons /, then press EXEC.

- You cannot select the “100MSDCF” folder as a recording folder.
- The image is stored in the newly selected folder. You cannot move recorded images to a different folder with this camera.

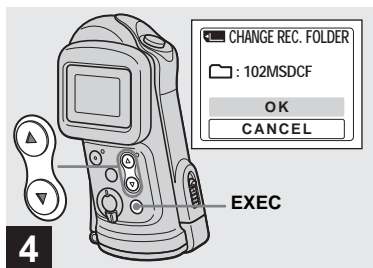

➔ **Select [OK] with the control button ▲, then press EXEC.**

When you press MENU, the menu disappears and the selected folder is displayed.

#### **To cancel changing the recording folder**

Select [CANCEL] in step **4**.

## Shooting according to scene conditions — Scene Selection

When shooting underwater, moving subjects, portraits, people at night, night scenes, or landscapes, use the modes below to improve the quality of your images.

### Underwater mode

This mode is used when shooting underwater where there is sunlight (up to depths of 1.5 m (5 feet)). The white balance is automatically adjusted to the appropriate setting to enable impressive underwater photographs of your subjects.



- When the camera is suddenly brought from a warm place into cold water, the lens may cloud. Allow the camera to adapt to the underwater temperature beforehand.
- When using underwater, see “Before using your camera” on page 4, “Precautions” on page 74 and “On the O-ring” on page 79 before use.

### Active outdoor mode

This mode lets you stop the movement of your subject and get lively shots of fast-moving objects in bright outdoor conditions.



- When setting the focus to [AUTO], the focus is adjusted to approximately 1 m to  $\infty$  (infinite).

### Soft snap mode

This mode lets you shoot skin colors in brighter and warmer tones for more beautiful pictures. In addition, the soft focus effect creates a gentle atmosphere for portraits of people, flowers, etc.



### Illumination snap mode

This mode lets you capture beautiful images of both subjects and night scene backgrounds at the same time. In addition, the cross filter effect enhances street lamps or other lights with cross-shaped rays.



- Note that as shutter speeds decrease, shaking increases.
- The flash strobes in red-eye reduction mode.
- When setting the focus to [AUTO], the focus is adjusted to approximately 1 m to  $\infty$  (infinite). To record subjects closer than 1 m, use the Focus preset (page 32).

## ☾ Twilight mode

This mode lets you shoot night scenes at far distances without losing the dark atmosphere of the surroundings.



- Note that as shutter speeds decrease, shaking increases.
- The focus setting changes to [▲ ∞].
- The flash cannot be used in this mode.
- When the focus setting is set to [AUTO], the focus is adjusted to telephoto.

## ▲ Vivid nature mode

This mode enhances blues and greens such as the sky, ocean and mountains, letting you shoot natural landscapes with vivid, striking colors.





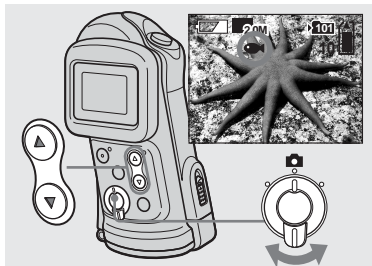



- The focus setting changes to [▲ ∞].
- The flash cannot be used in this mode.
- When the focus setting is set to [AUTO], the focus is adjusted to telephoto.



- ➔ **Set the mode switch to , and press the control button **▼ (SCENE)** repeatedly to select a desired mode.**

Each time you press ▼ (SCENE), the indicator changes as follows:

-  (Underwater mode) →  (Active outdoor mode) →  (Soft snap mode) →  (Illumination snap mode) →  (Twilight mode) →  (Vivid nature mode) → No indicator (Auto)

## To cancel Scene Selection

Press ▼ (SCENE) repeatedly to set to No indicator (Auto).

- If the menu is currently displayed, press MENU first so that the menu disappears.
- You cannot use the Scene Selection when shooting movies.
- The setting selected here is not maintained when the power is turned off.

## Setting the distance to the subject — Focus preset

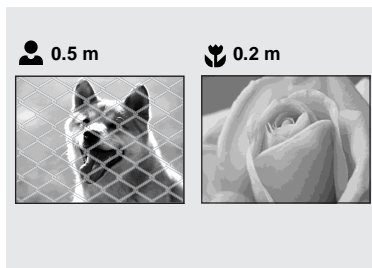

When shooting an image using a previously set distance to the subject, or when shooting a subject through a net or window glass, it is difficult to achieve a proper focus using the auto focus function. The Focus preset is useful in these cases.

- When shooting underwater, select the underwater mode for the Scene Selection function (page 30).





- 1** → Set the mode switch to , and press MENU.

The menu appears on the LCD screen.

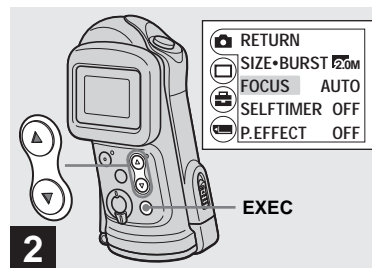
- You can also carry out this operation when the mode switch is set to .



- 2** → Select  with the control button ▲, then press EXEC. Select [FOCUS] with the control buttons ▲/▼, then press EXEC.

- When the mode switch is set to , select  with the control button ▲.
- Focus setting information is approximate, and should be used as a reference.

## Shooting five images continuously — Burst

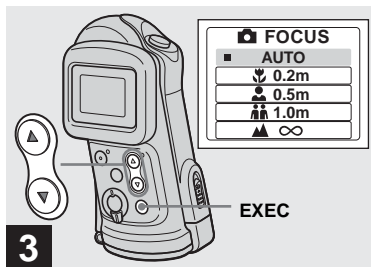

- ➔ Select the desired focus setting with the control buttons ▲/▼, then press EXEC.

You can select from the following distance settings:

AUTO (No indicator), 0.2 m, 0.5 m, 1.0 m, and ∞ (infinity)

When you press MENU, the menu disappears and the indicator is displayed on the LCD screen.

### To return to auto focus mode

Select [AUTO] in step 3.

- The setting selected here is not maintained when the power is turned off.

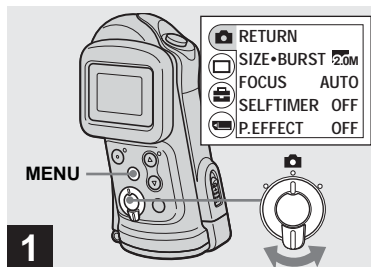

- ➔ Set the mode switch to , and press MENU.

The menu appears on the LCD screen.

- You cannot use the flash in this mode.
- You can shoot up to five images in succession by holding down the shutter button. If you release the shutter button before all five images are shot, the camera stops shooting as soon as you release the button.
- The recording interval is approximately 0.5 seconds. However, the recording interval may be longer in the Illumination snap mode or the Twilight mode.

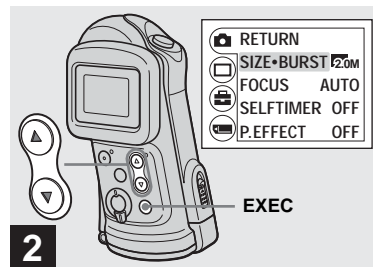

- ➔ Select [RETURN] with the control button ▲, then press EXEC. Select [SIZE-BURST] with the control buttons ▲/▼, then press EXEC.

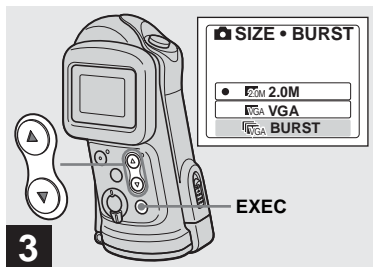

- Select [BURST] with the control button ▼, then press EXEC.

Press MENU so that the menu disappears from the LCD screen.

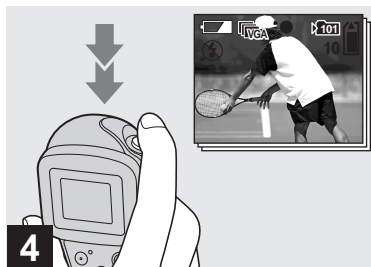

- Press the shutter button halfway down, then hold the shutter button fully down.

Up to five images are recorded as long as you hold down the shutter button. The images are recorded in VGA size.

- If you release the shutter button before the camera records five images, only the images that were shot while the shutter button was held down are recorded.

## Adding special effects — Picture Effect

You can digitally process images to obtain special effects.

### NEG. ART



The color and brightness of the picture are reversed as in a negative.

### SEPIA



The picture is sepia-toned like an old photograph.

### B&W



The picture is monochrome (black and white).

### SOLARIZE



The light contrast is clearer and the picture looks like an illustration.





**1** → Set the mode switch to , and press MENU.

The menu appears on the LCD screen.

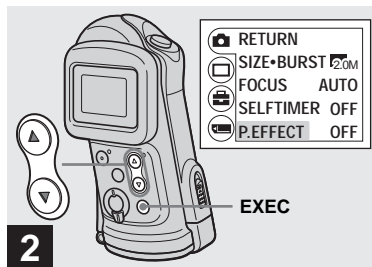
- You can also carry out this operation when the mode switch is set to .



**2** → Select [] with the control button ▲, then press EXEC. Select [P.EFFECT] with the control button ▼, then press EXEC.

- When the mode switch is set to , select [] with the control button ▲.

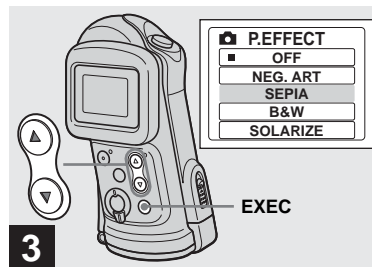

**3** → Select the desired mode with the control buttons ▲/▼, then press EXEC.

When you press MENU, the menu disappears and the selected mode is displayed on the LCD screen.

### To cancel Picture Effects

Select [OFF] in step **3**.

- The setting selected here is not maintained when the power is turned off.

## Viewing still images on the LCD screen

### Single (single-image) screen

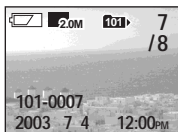

### Index (four-image) screen



You can view images shot with your camera almost immediately on the LCD screen. You can select the following two methods for viewing images.

### Single (single-image) screen

You can view one image at a time, displayed over the entire screen.

### Index (four-image) screen

Four images are displayed simultaneously in separate panels on the screen.

- For detailed descriptions of the screen indicators, see page 84.
- For details on viewing movies, see page 44.

## Viewing single images

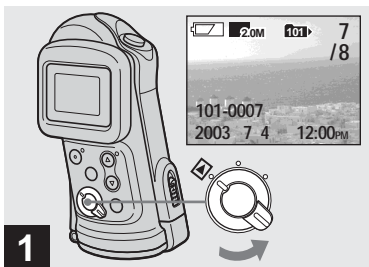

- ➔ **Set the mode switch to , and turn on the power.**

The last image in the selected recording folder (page 28) appears on the LCD screen.



- ➔ **Select the desired still image with the control buttons /▼.**

▲ : To display the preceding image  
▼ : To display the next image



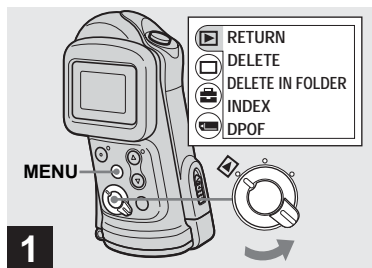

## Viewing an index screen (four-image)

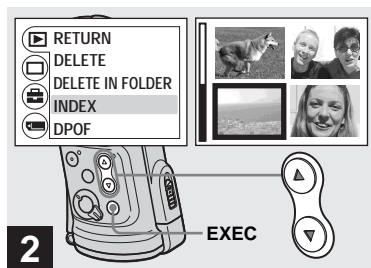

- 1** → Set the mode switch to , and press MENU.



The menu appears on the LCD screen.



- 2** → Select [] with the control button , then press EXEC. Select [INDEX] with the control buttons /, then press EXEC.

The display switches to the index (four-image) screen.

### To display the next (previous) index screen

Press the control buttons / to move the yellow border.

### To return to the single-image screen

Select [SINGLE] in step **2**, or press EXEC to display the single image shown with the yellow border when four frames are displayed.



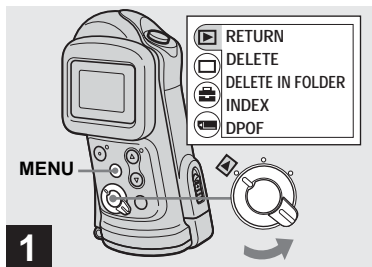

## Selecting the folder and playing back images — Folder

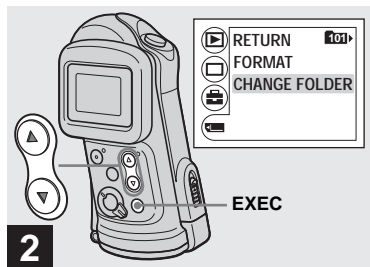

- ➔ Set the mode switch to , then press MENU.



The menu appears on the LCD screen.

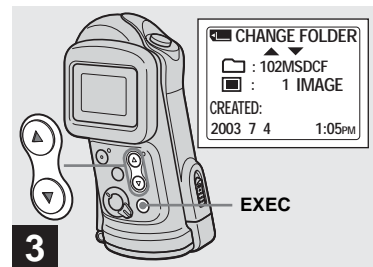

- ➔ Select [  ] with the control button , then press EXEC. Select [CHANGE FOLDER] with the control buttons , then press EXEC.

The CHANGE FOLDER screen appears.



- ➔ Select the desired folder with the control buttons , then press EXEC.

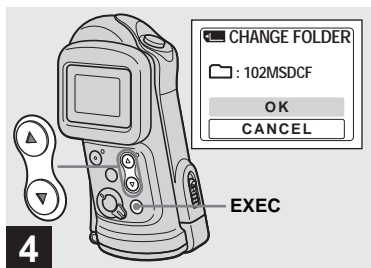

➔ Select [OK] with the control button ▲, then press EXEC.

When you press MENU, the menu disappears and the selected folder is displayed.

#### To cancel the selection

Select [CANCEL] in step **4**.

#### When multiple folders are created in the “Memory Stick”

When the first or last image in the folder is displayed, the following indicators appear on the LCD screen.

◀: Moves to the previous folder.

▶: Moves to the next folder.

◀▶: Moves to both the previous and next folders.

#### Single (single-image) screen

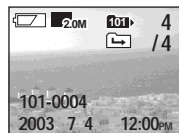

#### Index (four-image) screen



- When no images are stored in the folder, “NO FILE IN THIS FOLDER” appears.
- You can play back images from the last-shot one without selecting the folder.

## Enlarging an image — Enlarged playback

You can zoom in on an image shot with your camera to enlarge it to 2.5 or 5 times the original size.

1x (normal)





2.5x



5x



➔ Set the mode switch to , and select the image you want to enlarge with the control buttons /.

- Enlarged playback does not function for movies.
- You may not be able to enlarge images recorded using other devices.
- The enlarged image cannot be recorded as a new file.

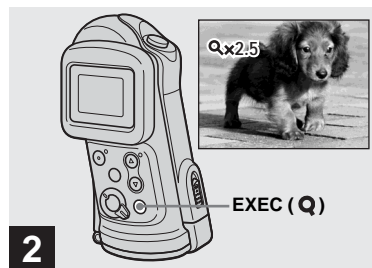

➔ Press EXEC (Q) repeatedly to select the desired enlargement level.

The center of the screen is enlarged. Each time you press EXEC (Q), the enlargement level changes as follows.

2.5x → 5x → No indicator (normal) → ...

### To cancel Enlarged playback

Press EXEC (Q) repeatedly to set to No indicator (normal).



- You can only enlarge the center of the screen.

## Choosing images to print — Print (DPOF) mark



You can mark still images shot with your camera that you want to have printed. This function is convenient when you have images printed at a shop or using a printer that conforms with the DPOF (Digital Print Order Format) standard.

- You cannot mark movies.

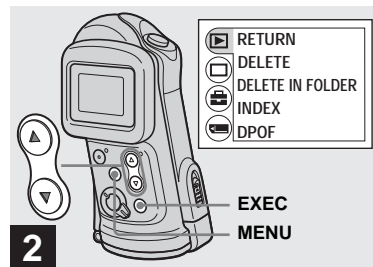

➔ Set the mode switch to , and display the image you want to print with the control buttons /.



➔ Press MENU, and select  with the control button , then press EXEC.

To mark the print (DPOF) mark in index-image screen

Perform step **2** on page 37 and switch to index screen.

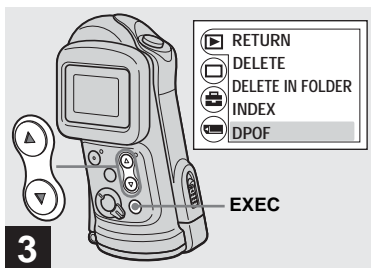

→ Select [DPOF] with the control button ▼, then press EXEC.

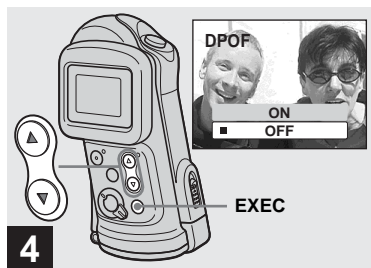

→ Select [ON] with the control button ▲, then press EXEC.

When you press MENU, the menu disappears and the  mark is marked on the displayed image.

#### **To unmark the print (DPOF) mark**

Select [OFF] in step **4**. The  mark disappears.

## Shooting movies

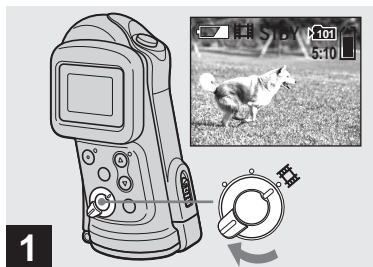

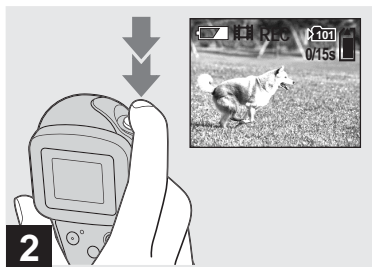

**1** → Set the mode switch to , and turn on the power.

- Sound cannot be recorded in movies.



**2** → Press the shutter button fully down.



“REC” appears on the LCD screen and the camera starts recording the image. The maximum recording time is 15 seconds per recording.

- The auto focus function can set the focus at any distance from approximately 1.0 m to ∞ (infinity). To shoot a subject at a closer distance than 1.0 m, select  0.2 m or  0.5 m with the Focus preset function (page 32).
- Recording stops when the “Memory Stick” is full.
- The flash does not function when shooting movies.



**3** → To stop recording, press the shutter button fully again.

### Indicators during shooting

Indicators on the LCD screen are not recorded. You can use [DISPLAY] under [ ] with MENU and the control buttons /  to turn the display on and off (page 24). For detailed descriptions of the indicators, see page 83.

### To use the self-timer

Set the mode switch to  and follow the procedure on page 24.

## Viewing movies on the LCD screen

### Shooting time

The shooting time is different, depending on the capacity of the “Memory Stick.” Refer to the following chart when you choose a “Memory Stick.”

- The maximum shooting time is 15 seconds per recording.
- The shooting time may vary, depending on the shooting conditions.
- For numbers of still images that can be recorded, see page 21.
- When shooting time exceeds 99 minutes 59 seconds “>99:59” is displayed.

Image size Capacity	160×112
8MB	5 min. 35 sec.
16MB	11 min. 13 sec.
32MB	22 min. 43 sec.
64MB	45 min. 40 sec.
128MB	1 h. 31 min. 34 sec.
MSX-256	2 h. 45 min. 35 sec.
MSX-512	5 h. 36 min. 43 sec.
MSX-1G	11 h. 27 min. 19 sec.



- ➔ Set the mode switch to , and turn on the power.

The last image in the selected recording folder (page 28) appears on the LCD screen.



- ➔ Select the desired movie with the control buttons ▲/▼.

▲ : To display the preceding image  
▼ : To display the next image



### ➔ Press EXEC.

The movie is played back.

### To stop playback

Press EXEC.



### Indicators while viewing movies

Indicators on the LCD screen are not recorded. You can use [DISPLAY] under [ ] with MENU and the control buttons ▲/▼ to turn the display on and off (page 24).



For detailed descriptions of the indicators, see page 84.

## Deleting images

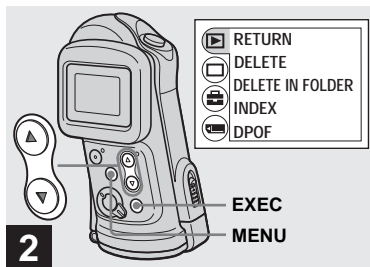

- ➔ Set the mode switch to , and turn on the power. Press the control buttons / to select the image you want to delete.



- ➔ Press MENU and select  with the control button , then press EXEC.

### To delete an image in index-image screen

Perform step **2** on page 37 and switch to index screen.

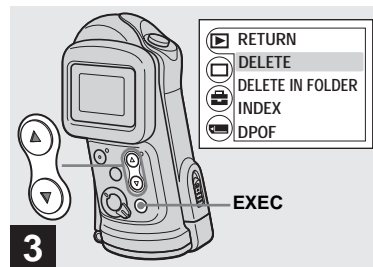

- ➔ Select [DELETE] with the control buttons /, then press EXEC.

The image has not yet been deleted at this point.

### To delete all the images in the folder

Select [DELETE IN FOLDER] in step **3**.

- You cannot delete images write-protected by another device.

## Formatting a “Memory Stick”

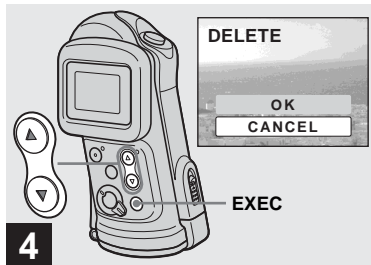

➔ Select [OK] with the control button ▲, then press EXEC.

When the message “MEMORY STICK ACCESS” disappears, the image has been deleted.

### To cancel deleting

Select [CANCEL] in step 4.

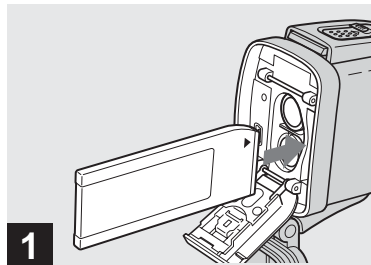

➔ Insert the “Memory Stick” you want to format into the camera.

Do not open the inner cover while formatting the “Memory Stick” as this may damage the “Memory Stick.”

- Before opening the waterproof cover, be sure to rinse off any sand and completely wipe away any water that may be present on the camera body.
- Inspect the O-ring and the O-ring mating surface on the inside of the camera for scratches, deformation, dirt, hair or other problems.

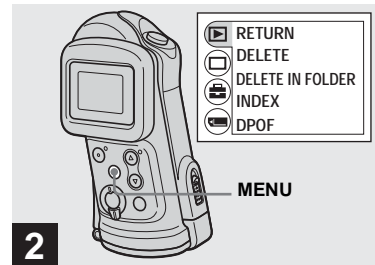

➔ Turn on the power, and press MENU.

The menu appears on the LCD screen.

- When you format a “Memory Stick,” be sure that sufficient power remains, otherwise a “FORMAT ERROR” may occur.
- This operation is available no matter what position the mode switch is in.

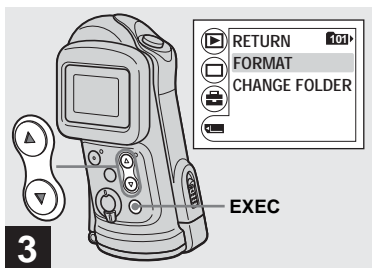

- 3** → Select [RETURN] with the control button ▼, then press EXEC. Select [FORMAT] with the control buttons ▲/▼, then press EXEC.

- The term “formatting” means preparing a “Memory Stick” to record images; this process is also called “initialization.” The “Memory Stick” provided with this camera, and those available commercially, are already formatted, and can be used immediately.
- **When you format a “Memory Stick,” note that all data in the “Memory Stick,” including images that were write-protected by another device, will be permanently erased.**

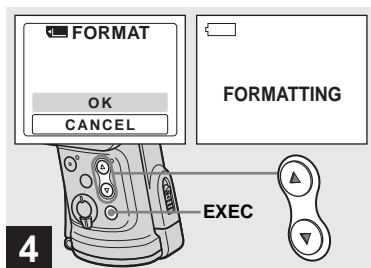

- 4** → Select [OK] with the control button ▲, then press EXEC.

When the message “FORMATTING” disappears, the format is complete.

#### To cancel formatting

Select [CANCEL] in step **4**.

## Recommended computer environment

**OS:** Microsoft Windows 98, Windows 98SE, Windows 2000 Professional, Windows Millennium Edition, Windows XP Home Edition, or Windows XP Professional

The above OS must be installed at the factory. Operation is not assured in an environment upgraded to the operating systems described above or in a multi-boot environment.

**CPU:** MMX Pentium 200 MHz or faster

**USB connector:** Provided as standard

**Display:** 800 × 600 dots or more

High Color (16-bit color, 65,000 colors) or more

- If you connect two or more USB equipment to a single computer at the same time, some equipment, including your camera, may not operate depending on the type of USB equipment.
- Operations are not guaranteed when using a USB hub.
- Operations are not guaranteed for all the recommended computer environments mentioned above.

## USB mode

There are two modes for a USB connection, [NORMAL] and [PTP]\* modes. The factory setting is the [NORMAL] mode. This section describes the USB connection using the [NORMAL] mode.

When the camera is connected to your computer via a USB cable, the camera can draw its power from your computer (USB Bus Powered).

\* Compatible only with Windows XP. When connected to a computer, only the data in the folder selected by the camera is copied to the computer. To select a folder when the camera is connected to your computer, press MENU and perform the procedures to change a folder for playback.

## Communication with your computer

When your computer resumes from the suspend or sleep mode, communication between your camera and your computer may not recover at the same time.

## When a USB connector is not provided on your computer

When neither a USB connector nor a “Memory Stick” slot is provided, you can

copy images using an additional device. See the Sony Website for details.  
<http://www.sony.net/>

## Contents of the CD-ROM

### ■ USB Driver

This driver is needed in order to connect the camera to a computer.

- When using Windows XP, you need not install the USB driver.

### ■ Image Transfer

This application is used to easily transfer images from the camera to a computer.

### ■ ImageMixer

This application is used to display and edit images that are stored in a computer.

- This section describes the Windows Me screen as an example. The required operations may differ depending on your OS.
- **Close down all applications running on the computer before installing the USB driver and application.**
- When using Windows XP or Windows 2000, log on as Administrator.
- The display settings should be 800 × 600 dots or more and High Color (16-bit color, 65 000 colors) or more. When set to less than 800 × 600 dots or 256 colors or less, the model selection screen does not appear.

## Installing the USB driver

When using Windows XP, you need not install the USB driver.

Once the USB driver is installed, you need not install the USB driver again.

- 1 Start up your computer, and insert the supplied CD-ROM into the CD-ROM drive.**

**Do not connect your camera to your computer at this time.**

The model selection screen appears. If it does not appear, double-click  (My Computer) → [ImageMixer] in that order.

- 2 Click [Cyber-shot] on the model selection screen.**



The installing menu screen appears.

- 3 Click [USB Driver] on the installing menu screen.**



The “InstallShield Wizard” screen appears.

- 4 Click [Next]. When the “Information” screen appears, click [Next].**



The USB driver installation starts. When the installation is completed, the screen informs you of completion.

- 5 Click [Yes, I want to restart my computer now], then click [Finish].**

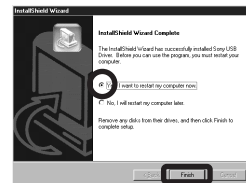

Your computer restarts. Then, you can establish USB connection.

## Installing “Image Transfer”

You can use the “Image Transfer” software to copy images to your computer automatically when you connect the camera to your computer with the supplied USB cable.

- 1 Click [Cyber-shot] on the model selection screen.



The installing menu screen appears.

- 2 Click [Image Transfer] on the installing menu screen. Select the desired language, then click [OK].



The “Welcome to the InstallShield Wizard” screen appears.

- This section describes the English screen.

- 3 Click [Next]. When the “Licence Agreement” screen appears, click [Yes].



Read the agreement carefully. If you accept the terms of the agreement, proceed with the installation. The “Information” screen appears.

- 4 Click [Next].



- 5 Select the folder to be installed, then click [Next]. Select the program folder, then click [Next].

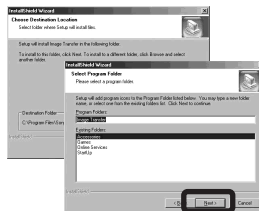

- 6 Confirm that the checkbox is checked on the “Image Transfer Settings” screen, then click [Next].



When the installation is completed, the screen informs you of completion.

## 7 Click [Finish].



The “InstallShield Wizard” screen closes.

If you wish to continue with the installation of “ImageMixer,” click [ImageMixer] on the installing menu screen and then follow the instructions that appear on the screen.

- The USB driver is needed in order to use “Image Transfer.” If the necessary driver is not already installed on your computer, a screen that asks if you want to install the driver will appear. Follow the instructions that appear on the screen.

## Installing “ImageMixer”

You can use the “ImageMixer Ver.1.5 for Sony” software to copy, view and edit images. For details, see the software’s help files.

- 1 Click [ImageMixer] on the installing menu screen. Select the desired language, then click [OK].



The “Welcome to the InstallShield Wizard” screen appears.

- This section describes the English screen.

- 2 Follow the instructions on each succeeding screen.

Install “ImageMixer” according to the instructions that appear on the screen.

- When you use Windows 2000 or Windows XP, install “WinASPL.”
- If DirectX8.0a or a later version is not installed in your computer, the “Information” screen appears. Follow the instructions that appear on the screen.

- 3 Restart your computer according to the instructions that appear on the screen.

- 4 Remove the CD-ROM.

## Connecting the camera to your computer

- 1** Insert the “Memory Stick” with the images you want to copy into the camera, then close the inner cover.

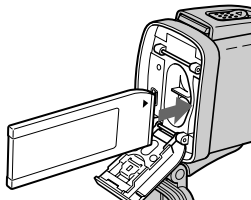

- The camera can receive power supply from most of the computers that are recommended for use through the USB connection (USB Bus Powered), so in this case there is no need to insert batteries into the camera.
- Removing the batteries before connecting the camera is recommended in order to prevent battery deterioration.
- For further details on inserting the “Memory Stick,” see page 18.

- 2** Turn on your computer.

- 3** Connect the supplied USB cable to the  $\psi$  (USB) jack of the camera.

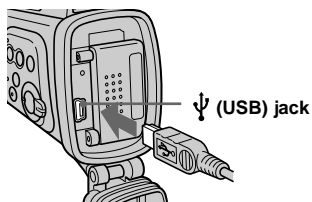

- Operations are not guaranteed when using a USB hub. Connect the camera directly to your computer.

- 4** Connect the USB cable to your computer.

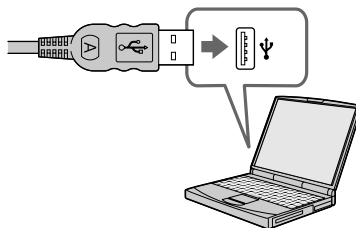

The camera turns on.

- Note that the power cannot be turned on if a “Memory Stick” is not inserted in the camera.
- When you use a desktop computer, we recommend that you connect the USB cable to the USB connector on the rear panel.
- When using Windows XP, the AutoPlay wizard automatically appears on the desktop. Proceed to page 56.

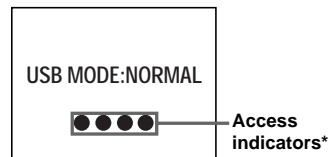



“USB MODE: NORMAL” appears on the LCD screen of the camera. When a USB connection is established for the first time, your computer automatically runs a program to recognize the camera. Wait for a while.

\* During communication, the access indicators turn red.

- If “USB MODE: NORMAL” is not shown in step **4**, confirm that [USB] is set to [NORMAL] under  in the menu settings (page 73).
- In USB mode, the POWER button and other controls on the camera do not function.

## ❗ Disconnecting the USB cable from your computer or removing the “Memory Stick” from your camera during USB connection

### For Windows 2000, Me, or XP users

- 1 Double-click  on the tasktray.
- 2 Click , then click [Stop].
- 3 Confirm the device on the confirmation screen, then click [OK].
- 4 Click [OK].  
Step 4 is unnecessary for Windows XP users.
- 5 Disconnect the USB cable or remove the “Memory Stick.”

### For Windows 98 or 98SE users

Confirm that the access indicators (page 53) on the LCD screen are turned white and carry out only Step 5 above.

## Copying images using “Image Transfer”

### — Windows 98/98SE/2000/Me

Connect the camera and your computer with the USB cable.

“Image Transfer” launches and the images are automatically copied to the computer.

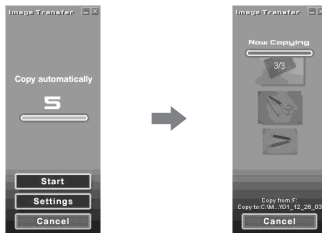

- Normally “Image Transfer” and “Date” folders are created inside the “My Documents” folder, and all of the image files recorded with the camera are copied into these folders.
- You can change the “Image Transfer” settings (page 55).
- When “ImageMixer” (page 52) is installed and image copying is completed using “Image Transfer,” “ImageMixer” automatically launches and images appear.

### — Windows XP

Connect the camera and your computer with the USB cable.

“Image Transfer” starts up automatically and the images are automatically copied to the computer.

Windows XP is set so that the OS AutoPlay Wizard activates.

If you want to cancel the setting, follow the procedure below.

**1** Click [Start], then click [My Computer].

**2** Right-click [Sony MemoryStick], then click [Properties].

**3** Cancel the setting.

- ① Click [AutoPlay].
- ② Set [Content type] to [Pictures].
- ③ Check [Select an action to perform] under [Actions], select [Take no action], then click [Apply].
- ④ Set [Content type] to [Video files] and repeat step ③. Then, set [Content type] to [Mixed content] and repeat step ③ again.
- ⑤ Click [OK].

The “Properties” screen closes. The OS AutoPlay Wizard does not start up automatically even if the USB connection is made next time.

## Changing “Image Transfer” settings

You can change “Image Transfer” settings. Right-click the “Image Transfer” icon on the tasktray, and select [Open Settings]. The settings you can set are as follows: [Basic], [Copy], and [Delete].

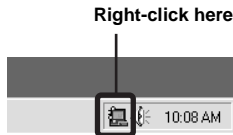

When “Image Transfer” starts, the window below appears.



When you select [Settings] from the above window, you can only change the [Basic] setting.

## Copying images without using “Image Transfer”

### — Windows 98/98SE/2000/Me

If “Image Transfer” is not set to launch automatically, you can copy images as following procedure.

#### 1 Double-click [My Computer], then double-click [Removable Disk].

The contents of the “Memory Stick” inserted in your camera appear.

- This section describes an example of copying images to the “My Documents” folder.
- When the “Removable Disk” icon is not shown, see the following column.
- When using Windows XP, see page 56.

#### 2 Double-click [DCIM], then double-click the folder which contains the desired images.





The folder opens.

#### 3 Drag and drop the image files into the “My Documents” folder.

The image files are copied to the “My Documents” folder.

- When you try to copy an image to a folder in which an image with the same file name is stored, the overwrite confirmation message appears. When you overwrite the existing image with the new one, the original file is deleted.

## When the removable disk icon is not shown

- 1 Right-click [My Computer], then click [Properties].  
The “System Properties” screen appears.
  - When using Windows 2000, click [Hardware] on the “System Properties” screen.
- 2 Confirm if other devices are already installed.
  - ① Click [Device Manager].
  - ② Confirm if there is a “ Sony DSC” with a  mark.
- 3 If you find either of the devices above, follow the steps below to delete them.
  - ① Click [ Sony DSC].
    - When using Windows 2000, right-click [ Sony DSC].
  - ② Click [Remove] (or [Uninstall] in Windows 2000).  
The “Confirm Device Removal” screen appears.
  - ③ Click [OK].  
The device is deleted.

Try the USB driver installation again using the supplied CD-ROM (page 50).

## — Windows XP

### Copying images using the Windows XP AutoPlay Wizard

- 1 Make a USB connection (page 53). Click [Copy pictures to a folder on my computer using Microsoft Scanner and Camera Wizard], then click [OK].**

The “Scanner and Camera Wizard” screen appears.

- 2 Click [Next].**

The images stored on the “Memory Stick” are displayed.

- 3 Click the checkbox of images that you do not want to copy to your computer and remove the checkmark, then click [Next].**

The “Picture Name and Destination” screen appears.

- 4 Select a name and destination for your pictures, then click [Next].**

Image copying starts. When the copying is completed, the “Other Options” screen appears.

- 5 Select [Nothing. I’m finished working with these pictures], then click [Next].**

The “Completing the Scanner and Camera Wizard” screen appears.

- 6 Click [Finish].**

The wizard closes.

- To continue copying other images, follow the procedure given under **1** on page 54 to disconnect the USB cable and reconnect it. Then, perform the procedure from step **1** again.

## *Viewing images on your computer*

### — Windows 98/98SE/2000/Me/XP

- 1 Double-click [My Documents] on the desktop.**

The “My Documents” folder contents are displayed.

- This section describes the procedure for viewing images copied in the “My Documents” folder.
- When using Windows XP, click [Start] → [My Documents] in that order.
- You can use the “ImageMixer Ver.1.5 for Sony” software to view and edit images on your computer. For details, see the software’s help files.

- 2 Double-click the desired folder and image file.**

The image is displayed.

## Image file storage destinations and file names

Image files recorded with your camera are grouped as folders in the “Memory Stick.”

### Example: For Windows Me users

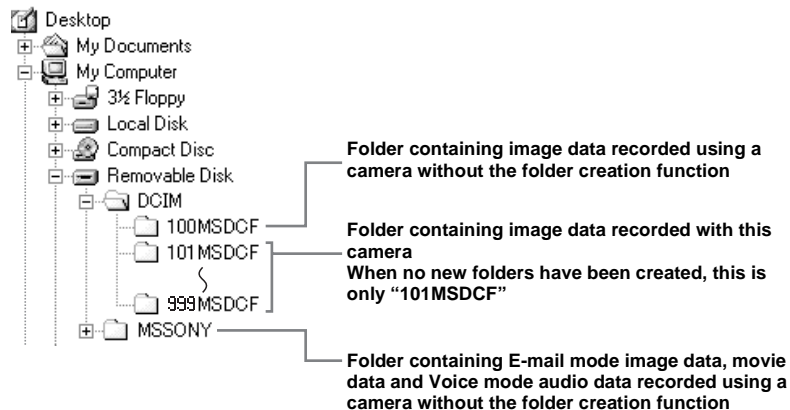

Folder	File name	File meaning
101MSDCF up to 999MSDCF	DSC0□□□□.JPG	Still image files
	MOV0□□□□.MPG	Movie files

- Data in the “100MSDCF” or “MSSONY” folders is for playback only, and your camera cannot record images in these folders.
- For more information about the folder, see page 26.
- □□□□ stands for any number within the range from 0001 to 9999.

# Copying images to your computer — For Macintosh users

## Recommended computer environment

**OS:** Mac OS 8.5.1, 8.6, 9.0, 9.1, 9.2, or Mac OS X (v10.0/v10.1/v10.2)

The above OS must be installed at the factory. For the following models, update your OS to Mac OS 9.0, 9.1 or 9.2.

- iMac with Mac OS 8.6 installed at the factory, and a slot loading type CD-ROM drive
- iBook or Power Mac G4 with the Mac OS 8.6 installed at the factory

**USB connector:** Provided as standard

**Display:** 800 × 600 dots or more  
32,000-color mode or more

- If you connect two or more USB equipment to a single computer at the same time, some equipment, including your camera, may not operate depending on the type of USB equipment.
- Operations are not guaranteed when using a USB hub.
- Operations are not guaranteed for all the recommended computer environments mentioned above.

## USB mode

There are two modes for a USB connection, [NORMAL] and [PTP]\* modes. The factory setting is the [NORMAL] mode.

This section describes the USB connection using the [NORMAL] mode.

When the camera is connected to your computer via a USB cable, the camera can draw its power from your computer (USB Bus Powered).

\* Compatible only with Mac OS X. When connected to a computer, only the data in the folder selected by the camera is copied to the computer. To select a folder when the camera is connected to your computer, press MENU and perform the procedures to change a folder for playback.

## Communication with your computer

When your computer resumes from the suspend or sleep mode, communication between your camera and your computer may not recover at the same time.

## When a USB connector is not provided on your computer

When neither a USB connector nor a “Memory Stick” slot is provided, you can copy images using an additional device. See the Sony Website for details.  
<http://www.sony.net/>

## Steps required by your OS

Follow the steps below, according to your OS.

OS	Steps
Mac OS 8.5.1/8.6/9.0	Steps <b>1</b> to <b>4</b>
Mac OS 9.1/9.2/ Mac OS X (v10.0/v10.1/v10.2)	Steps <b>2</b> to <b>4</b>

## 1 Installing the USB driver

- 1 Turn on your computer, and set the supplied CD-ROM into the CD-ROM drive.  
The model selection screen appears.
- 2 Click [Cyber-shot] on the model selection screen.  
The installing menu screen appears.
- 3 Click [USB Driver].  
The “USB Driver” screen appears.
- 4 Double-click the icon of the hard disk containing the OS to open the screen.
- 5 Drag and drop the following two files from the screen opened in step 3 into the System Folder icon in the screen opened in step 4.
  - Sony USB Driver
  - Sony USB Shim
- 6 When the message for confirmation is shown, click [OK].
- 7 Restart your computer, then remove the CD-ROM.

## 2 Connecting your camera to your computer

For details, see page 53.

## Disconnecting the USB cable from your computer or removing the “Memory Stick” from your camera during USB connection

Drag and drop the drive icon or the “Memory Stick” icon to the “Trash” icon, then disconnect the USB cable or remove the “Memory Stick.”

- If you are using Mac OS X v10.0, disconnect the USB cable, etc., after you have turned your computer off.

## 3 Copying images

- 1 Double-click the newly recognized icon on the desktop.  
The contents of the “Memory Stick” inserted in your camera appear.
- 2 Double-click [DCIM].
- 3 Double-click the folder containing the desired image files.
- 4 Drag and drop the image files to the hard disk icon.  
The image files are copied to your hard disk.
  - See page 57 for details about the image file storage destinations and file names.

## 4 Viewing the images on your computer

- 1 Double-click the hard disk icon.
- 2 Double-click the desired image file in the folder containing the copied files.  
The image file opens.
  - **Close down all applications running on the computer before installing the USB driver and application.**
  - You can use the “ImageMixer Ver.1.5 for Sony” software to copy images to your computer and to view images on your computer. See the operation manual supplied with the CD-ROM for details about the installation method, or see the software’s help files for the operation method.
  - “ImageMixer” is not compatible with Mac OS X.
  - “Image Transfer” cannot be used with Macintosh.

# Creating a Video CD using "ImageMixer"

You can create a Video CD using "ImageMixer Ver.1.5 for Sony." You can play back created Video CDs on a Video CD-compatible DVD player, or on a computer using Video CD application software.

## 1 Start "ImageMixer."

## 2 Click .

The video CD creating mode turns on.

## 3 Drag & drop the desired file or album to the menu screen.



The selected image is added to the menu screen.

- This section describes the English screen.

## 4 Click .

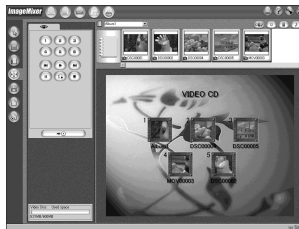

You can preview the image.

## 5 Click .



The disc creating dialogue appears.

## 6 Insert a blank CD-R into the CD-R drive and click [OK].

The disc creation starts.

- You cannot use CD-RW discs.
- The CD-R drive is required to create a Video CD.

### For the Macintosh edition

- Roxio-manufactured "Toast" (not supplied) is required to create a Video CD.
- The playback time of the movie file becomes shorter on the preview screen.

# Troubleshooting

If you experience trouble with your camera, try the following solutions.

1 First check the items on the tables below.

**If code “C:□□:□□” is displayed on the LCD screen, the self-diagnosis display function is working (page 70).**

2 Should your camera still not work properly, open the waterproof cover to press the RESET button using a fine-tipped object, then close the cover and turn on the power again. (All the settings including date and time are cleared.)

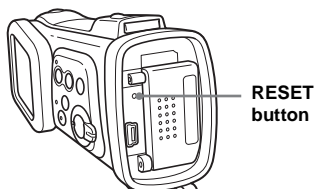







3 Should your camera still not work properly, consult your Sony dealer or local authorized Sony service facility.













## Batteries and power

Symptom	Cause	Solution
The battery remaining indicator is incorrect, or sufficient battery remaining indicator is displayed but the power runs out soon.	<ul style="list-style-type: none"><li>You have used the camera in an extremely cold location.</li><li>The batteries are discharged.</li><li>The battery contacts or the terminals on the inner cover are dirty.</li><li>The batteries are exhibiting the “memory effect” (page 11).</li><li>The batteries are dead (page 78).</li></ul>	<p>—</p> <p>→ Install charged batteries (page 10).</p> <p>→ Wipe any dirt off from them with a dry cloth (page 11).</p> <p>→ To restore the batteries to their original condition, use them until they are fully drained before recharging them.</p> <p>→ Replace the batteries with new ones.</p>
The battery life is short.	<ul style="list-style-type: none"><li>You are shooting/viewing images in an extremely cold location.</li><li>The batteries are not charged enough.</li><li>The batteries are dead (page 78).</li></ul>	<p>—</p> <p>→ Charge the batteries (page 10).</p> <p>→ Replace the batteries with new ones.</p>



Symptom	Cause	Solution
<b>You cannot turn on the camera.</b>	<ul style="list-style-type: none"> <li>The batteries are not installed correctly.</li> <li>The batteries are discharged.</li> <li>The batteries are dead (page 78).</li> </ul>	<ul style="list-style-type: none"> <li>→ Install the batteries correctly (page 12).</li> <li>→ Replace them with charged batteries (page 10).</li> <li>→ Replace the batteries with new ones.</li> </ul>
<b>The power turns off suddenly.</b>	<ul style="list-style-type: none"> <li>If you do not operate the camera for about three minutes when using batteries, the camera turns off automatically to prevent wearing down the batteries (page 15).</li> <li>The batteries are discharged.</li> </ul>	<ul style="list-style-type: none"> <li>→ Turn on the camera again (page 15).</li> <li>→ Replace them with charged batteries (page 10).</li> </ul>

### Shooting still images/movies

Symptom	Cause	Solution
<b>The subject does not appear on the LCD screen.</b>	<ul style="list-style-type: none"> <li>The mode switch is set to .</li> </ul>	<ul style="list-style-type: none"> <li>→ Set the mode switch to  or  (pages 22 and 43).</li> </ul>
<b>The image is out of focus.</b>	<ul style="list-style-type: none"> <li>The subject is too close.</li> <li>When shooting still images,  (Active outdoor mode),  (Illumination snap mode),  (Twilight mode) or  (Vivid nature mode) is selected for the Scene Selection function.</li> <li>You are shooting movies at a distance closer than 1.0 m (3 feet 3 3/8 inches).</li> <li>The Focus preset function is selected.</li> </ul>	<ul style="list-style-type: none"> <li>→ Make sure to position the lens farther away from the subject than the minimum shooting distance of 10 cm (4 inches) (or 15 cm (6 inches) underwater) when shooting (page 32).</li> <li>→ Cancel the Scene Selection function (page 31).</li> <li>→ Select the Focus preset function (page 32).</li> <li>→ Set it to [AUTO] (page 33).</li> </ul>
<b>The image is too dark.</b>	<ul style="list-style-type: none"> <li>The LCD screen is too dark.</li> </ul>	<ul style="list-style-type: none"> <li>→ Set [LCD LIGHT] to [ON] (pages 23 and 73).</li> </ul>
<b>The image is too bright.</b>	<ul style="list-style-type: none"> <li>The LCD screen is too bright.</li> </ul>	<ul style="list-style-type: none"> <li>→ Set [LCD LIGHT] to [OFF] (pages 23 and 73).</li> </ul>
<b>The image is monochrome (black and white).</b>	<ul style="list-style-type: none"> <li>[P. EFFECT] is set to [B&amp;W] mode.</li> </ul>	<ul style="list-style-type: none"> <li>→ Cancel [B&amp;W] mode (page 34).</li> </ul>
<b>Vertical streaks appear when you are shooting a very bright subject.</b>	<ul style="list-style-type: none"> <li>The smear phenomenon is occurring.</li> </ul>	<ul style="list-style-type: none"> <li>→ This is not a malfunction.</li> </ul>

Symptom	Cause	Solution
<b>Your camera cannot record images.</b>	<ul style="list-style-type: none"> <li>No “Memory Stick” is inserted.</li> <li>The capacity of the “Memory Stick” is insufficient.</li> <li>The write-protect switch on the “Memory Stick” is set to the LOCK position.</li> <li>You cannot shoot while the flash is charging.</li> <li>The mode switch is not set to  when shooting a still image.</li> <li>The mode switch is not set to  when shooting a movie.</li> </ul>	<ul style="list-style-type: none"> <li>→ Insert a “Memory Stick” (page 18).</li> <li>→ Delete the images saved in the “Memory Stick” (page 46), or format it (page 47).</li> <li>→ Change the “Memory Stick.”</li> <li>→ Set it to the recording position (page 76).</li> <li>—</li> <li>→ Set it to  (page 22).</li> <li>→ Set it to  (page 43).</li> </ul>
<b>The flash does not work.</b>	<ul style="list-style-type: none"> <li>The mode switch is set to  or .</li> <li>The flash is set to  (No flash).</li> <li>When shooting still images, either  (Twilight mode) or  (Vivid nature mode) is selected for the Scene Selection function, or the camera is in Burst mode.</li> </ul>	<ul style="list-style-type: none"> <li>→ Set it to .</li> <li>→ Set the flash to auto (no indicator),  (Red-eye reduction) or  (Forced flash) (page 25).</li> <li>→ Set it to other modes (pages 20 and 31).</li> </ul>
<b>The eyes of the subject come out red.</b>	—	→ Set the flash mode to  (Red-eye reduction) (page 25).
<b>The date and time are recorded incorrectly.</b>	<ul style="list-style-type: none"> <li>The date and time are not set correctly.</li> </ul>	→ Set the correct date and time (page 16).

## Viewing images

Symptom	Cause	Solution
<b>Your camera cannot play back images.</b>	<ul style="list-style-type: none"> <li>The mode switch is not set to .</li> <li>Your camera cannot play back image files copied from the hard disk of your computer if the folder/file name has been changed or the image has been modified.</li> <li>The camera is in USB mode.</li> </ul>	<ul style="list-style-type: none"> <li>→ Set it to  (page 36).</li> <li>—</li> <li>→ Cancel the USB connection (pages 54 and 59).</li> </ul>
<b>The image cannot be played back on a computer.</b>	—	→ See page 65.

Symptom	Cause	Solution
<b>Your camera cannot perform enlarged playback.</b>	<ul style="list-style-type: none"> <li>• Enlarged playback is not available for files created or processed using other devices.</li> </ul>	—
<b>You cannot display a print (DPOF) mark.</b>	<ul style="list-style-type: none"> <li>• You cannot display print (DPOF) marks on movies.</li> </ul>	—

### Deleting images

Symptom	Cause	Solution
<b>Your camera cannot delete an image.</b>	<ul style="list-style-type: none"> <li>• The write-protect switch on the “Memory Stick” is set to the LOCK position.</li> </ul>	→ Set it to the recording position (page 76).
<b>You have deleted an image by mistake.</b>	<ul style="list-style-type: none"> <li>• Once you have deleted an image, you cannot restore it.</li> </ul>	→ The write-protect switch on the “Memory Stick” will prevent you from deleting images by mistake (page 76).

### Computers

Symptom	Cause	Solution
<b>You do not know if the OS of your computer is compatible.</b>	—	→ Check “Recommended computer environment” (pages 49 and 58).
<b>You cannot install the USB driver.</b>	—	→ In Windows 2000, log on as Administrator (authorized Administrator) (page 49).

Symptom	Cause	Solution
<b>Your computer does not recognize your camera.</b>	<ul style="list-style-type: none"> <li>• You are not using the supplied USB cable.</li> <li>• The USB cable is not connected firmly.</li>   <li>• [USB] is set to [PTP] under [ ] in the menu settings.</li> <li>• The USB connectors on your computer are connected to other equipment besides the keyboard, the mouse, and your camera.</li> <li>• The camera is not connected directly to your computer.</li> <li>• The USB driver is not installed.</li> <li>• The camera was connected to a computer with the USB cable before installing the USB driver, so the device was not recognized by the computer.</li> </ul>	<ul style="list-style-type: none"> <li>→ Use the supplied USB cable (page 53).</li> <li>→ Disconnect the USB cable, and connect it again firmly. Make sure that “USB MODE” is displayed on the LCD screen (pages 53 and 59).</li> <li>→ Set it to [NORMAL] (page 73).</li>   <li>→ Disconnect the USB cables except for the ones connected to the keyboard, the mouse, and your camera.</li>   <li>→ Connect the camera directly to your computer without passing through a hub or other device.</li> <li>→ Install the USB driver (pages 50 and 59).</li> <li>→ Delete the device which is not recognized, then install the USB driver (pages 50, 55 and 59).</li> </ul>
<b>You cannot turn on the camera during USB connection.</b>	<ul style="list-style-type: none"> <li>• The camera is not connected directly to your computer.</li> <li>• No “Memory Stick” is inserted.</li> </ul>	<ul style="list-style-type: none"> <li>→ Connect the camera directly to your computer without passing through a hub or other device.</li> <li>→ Insert a “Memory Stick” (page 18).</li> </ul>
<b>You cannot copy images.</b>	<ul style="list-style-type: none"> <li>• The camera is not correctly connected to your computer.</li> <li>• You are not using the correct copy procedure for your OS.</li> <li>—</li> <li>—</li> </ul>	<ul style="list-style-type: none"> <li>→ Connect the camera and your computer correctly using the supplied USB cable (page 53).</li> <li>→ Follow the designated copy procedure for your OS (pages 54, 55 and 59).</li> <li>→ If you are using the “Image Transfer” software, see page 54.</li> <li>→ If you are using the “ImageMixer Ver.1.5 for Sony” application software, click on HELP.</li> </ul>
<b>After making a USB connection, “Image Transfer” does not automatically start.</b>	<ul style="list-style-type: none"> <li>—</li> <li>—</li> </ul>	<ul style="list-style-type: none"> <li>→ Select [Launch Image Transfer automatically when the camera, etc., is connected.] at [Basic] setting (page 55).</li> <li>→ Make a USB connection when the computer is turned on (page 53).</li> </ul>
<b>The image cannot be played back on a computer.</b>	<ul style="list-style-type: none"> <li>—</li> <li>—</li> </ul>	<ul style="list-style-type: none"> <li>→ If you are using the “ImageMixer Ver.1.5 for Sony” application software, click on HELP.</li> <li>→ Consult the computer or software manufacturer.</li> </ul>

Symptom	Cause	Solution
The image is interrupted by noise when you view a movie on a computer.	<ul style="list-style-type: none"> <li>You are playing back the movie directly from the "Memory Stick."</li> </ul>	→ Copy the movie to the hard disk of your computer and then play back the movie from the hard disk (pages 54, 55 and 59).
You cannot print an image.	— —	→ Check the printer settings. → Click on HELP for the "ImageMixer Ver.1.5 for Sony" application software.
An error message appears when you set the supplied CD-ROM in your computer.	<ul style="list-style-type: none"> <li>The computer display is not set correctly.</li> </ul>	→ Set the computer display as follows: Windows: 800 × 600 dots or more High Color (16-bit color, 65,000 colors) or more Macintosh: 800 × 600 dots or more 32,000-color or more

### "Memory Stick"

Symptom	Cause	Solution
You cannot insert a "Memory Stick."	<ul style="list-style-type: none"> <li>You are inserting it backwards.</li> </ul>	→ Insert it from the right side (page 18).
You cannot record on a "Memory Stick."	<ul style="list-style-type: none"> <li>The write-protect switch on the "Memory Stick" is set to the LOCK position.</li> <li>The "Memory Stick" is full.</li> </ul>	→ Set it to the recording position (page 76). → Delete unnecessary images (page 46).
You cannot format a "Memory Stick."	<ul style="list-style-type: none"> <li>The write-protect switch on the "Memory Stick" is set to the LOCK position.</li> </ul>	→ Set it to the recording position (page 76).
You have formatted a "Memory Stick" by mistake.	<ul style="list-style-type: none"> <li>When you format a "Memory Stick," all data in the "Memory Stick," including images that were write-protected by another device, will be permanently erased and cannot be restored.</li> </ul>	→ We recommend that you set the "Memory Stick" write-protect switch to the LOCK position to prevent accidental erasure (page 76).

## Others

Symptom	Cause	Solution
<b>Your camera does not work.</b>	<ul style="list-style-type: none"><li>• The battery level is low. (The  indicator appears.)</li><li>• The USB cable is connected.</li></ul>	<ul style="list-style-type: none"><li>→ Charge the batteries (page 10).</li><li>→ Disconnect the USB cable (pages 54 and 59).</li></ul>
<b>The power is on, but the camera does not work.</b>	<ul style="list-style-type: none"><li>• The built-in microcomputer is not working properly.</li></ul>	<ul style="list-style-type: none"><li>→ Remove the batteries, then install them again after about one minute and turn on the camera. If the functions still do not work, open the waterproof cover to press the RESET button using a fine-tipped object, then close the cover and turn the power on again (page 61). (If you press the RESET button, all settings including the date and time are cleared.)</li></ul>
<b>You cannot identify an indicator on the LCD screen.</b>	—	<ul style="list-style-type: none"><li>→ Check the indicator (pages 83 and 84).</li></ul>
<b>The lens portion gets fogged.</b>	<ul style="list-style-type: none"><li>• Moisture condensation has occurred.</li></ul>	<ul style="list-style-type: none"><li>→ Turn off the camera and leave it for about an hour at the room temperature for the moisture to evaporate before use (page 75).</li></ul>

## Warnings and messages

The following messages appear on the LCD screen.

Message	Meaning/Corrective Action
<b>NO MEMORY STICK</b>	<ul style="list-style-type: none"><li>• Insert a “Memory Stick” (page 18).</li></ul>
<b>SYSTEM ERROR</b>	<ul style="list-style-type: none"><li>• Turn the power off and on again (page 15).</li></ul>
<b>MEMORY STICK ERROR</b>	<ul style="list-style-type: none"><li>• The inserted “Memory Stick” cannot be used in your camera (page 76).</li><li>• The “Memory Stick” is damaged, or the terminal section of the “Memory Stick” is dirty.</li><li>• Insert the “Memory Stick” correctly (page 18).</li></ul>
<b>MEMORY STICK TYPE ERROR</b>	<ul style="list-style-type: none"><li>• The inserted “Memory Stick” cannot be used in your camera (page 76).</li></ul>
<b>FORMAT ERROR</b>	<ul style="list-style-type: none"><li>• The “Memory Stick” format failed. Format the “Memory Stick” again (page 47).</li></ul>
<b>MEMORY STICK LOCKED</b>	<ul style="list-style-type: none"><li>• The write-protect switch on the “Memory Stick” is set to the LOCK position. Set it to the recording position (page 76).</li></ul>
<b>NO MEMORY SPACE</b>	<ul style="list-style-type: none"><li>• The capacity of the “Memory Stick” is insufficient. You cannot record images. Delete unnecessary images (page 46).</li></ul>
<b>NO FILE IN THIS FOLDER</b>	<ul style="list-style-type: none"><li>• No images have been recorded in this folder.</li></ul>
<b>FOLDER ERROR</b>	<ul style="list-style-type: none"><li>• A folder with the same first three digits number already exists in the “Memory Stick.” (For example: 123MSDCF and 123ABCDE) Select other folders, or create a new folder.</li></ul>
<b>CANNOT CREATE MORE FOLDERS</b>	<ul style="list-style-type: none"><li>• The folder whose first three digits of the name is “999” exists in the “Memory Stick.” You cannot create any folders.</li></ul>
<b>CANNOT RECORD</b>	<ul style="list-style-type: none"><li>• The camera cannot record images in the selected folder. Select a different folder (page 28).</li></ul>
<b>FILE ERROR</b>	<ul style="list-style-type: none"><li>• An error occurred while playing back the image.</li></ul>
<b>FILE PROTECT</b>	<ul style="list-style-type: none"><li>• The image is write-protected by another device. Release the protection by another device.</li></ul>
<b>IMAGE SIZE OVER</b>	<ul style="list-style-type: none"><li>• You are attempting to play back an image of a size that cannot be played back on your camera.</li></ul>
<b>INVALID OPERATION</b>	<ul style="list-style-type: none"><li>• You are attempting to assign the print (DPOF) mark to a file that was created by another device.</li></ul>
	<ul style="list-style-type: none"><li>• The battery level is low or zero. Charge the batteries (page 10). Depending on the conditions of use, the indicator may flash even though there are still 5 to 10 minutes of remaining battery time left.</li></ul>

Message	Meaning/Corrective Action
<b>ENLARGED PLAYBACK ERROR</b>	<ul style="list-style-type: none"><li>• You are attempting to perform enlarged playback for a file created using other devices.</li><li>• Enlarged playback is not available for images processed using a computer.</li><li>• An error occurred while your camera was performing enlarged playback.</li></ul>

## Self-diagnosis display

— If a code starting with an alphabet letter appears

Your camera has a self-diagnosis display. This function displays the camera condition on the LCD screen with a combination of a letter and four numerical digits.

If this occurs, check the following code chart and attempt the corresponding corrective actions. The last two digits (indicated by □□) will differ depending on the state of the camera.

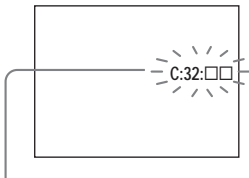

Self-diagnosis display

Code	Cause	Countermeasure
<b>C:32:</b> □□	There is trouble with your camera's hardware.	• Turn the power off and on again (page 15).
<b>C:13:</b> □□	The camera cannot read or write data on the "Memory Stick."	• Re-insert the "Memory Stick" several times.
	An unformatted "Memory Stick" is inserted.	• Format the "Memory Stick" (page 47).
	The inserted "Memory Stick" cannot be used with your camera, or the data is damaged.	• Insert a new "Memory Stick" (page 18).
<b>E:61:</b> □□ <b>E:91:</b> □□	A camera malfunction that you cannot reverse has occurred.	• Open the waterproof cover to press the RESET button (page 61), then close the cover and turn the power on again.

If you are unable to solve the problem even after trying the corrective actions a few times, repairs may be necessary. Contact your Sony dealer or local authorized Sony service facility and inform them of the 5-digit code.





Example: E:61:10

## Menu items





Menu items that can be modified differ depending on the position of the mode switch.



The LCD screen shows only the items you can operate at the moment. Factory settings are indicated with ■.

### When the mode switch is set to (when [] is selected in the menu settings)

Item	Setting	Description
SIZE·BURST	■2.0M / VGA / BURST	Selects the image size when shooting still images (pages 20 and 33).
FOCUS	■AUTO /  0.2 m /  0.5 m /  1.0 m /  ∞	Selects the auto focus method or sets the focus preset distance (page 32).
SELFTIMER	ON / ■OFF	Sets the self-timer (page 24).
P.EFFECT	■OFF / NEG. ART / SEPIA / B&W / SOLARIZE	Sets the image special effects (page 34).

### When the mode switch is set to (when [] is selected in the menu settings)

Item	Setting	Description
FOCUS	■AUTO /  0.2 m /  0.5 m /  1.0 m /  ∞	Selects the auto focus method or sets the focus preset distance (page 32).
SELFTIMER	ON / ■OFF	Sets the self-timer (page 24).
P.EFFECT	■OFF / NEG. ART / SEPIA / B&W / SOLARIZE	Sets the image special effects (page 34).

**When the mode switch is set to  or  (when [] is selected in the menu settings)**

Item	Setting	Description
<b>FORMAT</b>	OK / CANCEL	Formats the “Memory Stick.” When you format a “Memory Stick,” note that all data in the “Memory Stick,” including images that were write-protected by another device, will be permanently erased (page 47).
<b>CREATE FOLDER</b>	OK / CANCEL	Creates a folder for recording images (page 27).
<b>CHANGE FOLDER</b>	OK / CANCEL	Changes a folder for recording images (page 28).

**When the mode switch is set to  (when [] is selected in the menu settings)**

Item	Setting	Description
<b>DELETE</b>	OK / CANCEL	Deletes the displayed image (page 46).
<b>DELETE IN FOLDER</b>	OK / CANCEL	Deletes all images in the folder (page 46).
<b>INDEX / SINGLE</b>	—	Switches between four-image display and single image display (page 36).
<b>DPOF</b>	ON /  OFF	Marks/unmarks the print (DPOF) mark on still images you want to print (page 41).

**When the mode switch is set to  (when [] is selected in the menu settings)**

Item	Setting	Description
<b>FORMAT</b>	OK / CANCEL	Formats the “Memory Stick.” When you format a “Memory Stick,” note that all data in the “Memory Stick,” including images that were write-protected by another device, will be permanently erased (page 47).
<b>CHANGE FOLDER</b>	OK / CANCEL	Selects the folder containing the images you want to play back (page 38).

The following menus are available no matter what position the mode switch is in.

When [ ] is selected in the menu settings

Item	Setting	Description
LCD LIGHT	■ ON / OFF	Selects the brightness of the LCD screen. Selecting [ON] makes the screen bright and easy to see when using the camera in dark locations, but also uses up the battery charge faster (page 23).
DISPLAY	■ ON OFF	<ul style="list-style-type: none"> <li>– Displays all indicators.</li> <li>– Displays warning messages, etc.</li> </ul>

When [ ] is selected in the menu settings

Item	Setting	Description
CLOCK SET	DATE NOTATION DATE&TIME SET	<ul style="list-style-type: none"> <li>– Sets the date notation (page 16). ■ [Y/M/D] / [M/D/Y] / [D/M/Y]</li> <li>– Sets the date and time (page 16).</li> </ul>
BEEP	■ ON SHUTTER OFF	<ul style="list-style-type: none"> <li>– Turns on the beep when you press the control button/shutter button.</li> <li>– Turns on the beep when you press the shutter button.</li> <li>– Turns off the beep.</li> </ul>
USB	■ NORMAL / PTP	Switches the USB mode (page 49).
A LANGUAGE	—	Displays the menu items, warnings and messages in selected language.

### Do not leave the camera in the following places

- In extremely hot place, such as in a car parked in the sun. The camera body may become deformed or this may cause a malfunction.
- Under direct sunlight or near a heater. The camera body may become deformed or this may cause a malfunction.
- On rocking vibration.
- Near strong magnetic place.

### Notes on use

- Do not open the waterproof cover underwater, in places exposed to water, at the seashore or other places with lots of sand dust. Water or sand entering the inside of the camera may cause a malfunction or irreparable damage.
- When not using the camera for a long period of time, turn on the power once every so often.  
Shoot and play back images or otherwise operate the camera for about 3 minutes to ensure proper operation.
- Do not connect the battery charger to an electronic type transformer or other overseas travel equipment. This may cause the battery charger to become excessively hot or cause a malfunction.

### On charging the batteries

- To protect the batteries, remove the batteries from the battery charger within 24 hours after charging is completed.
- Charging the batteries in an ambient temperature of 10°C to 30°C is recommended.

### On cleaning

#### Cleaning the LCD screen

Wipe the screen surface with an LCD cleaning kit (not supplied) to remove fingerprints, dust, etc.

#### Cleaning the lens

Wipe the lens surface with a soft cloth to remove fingerprints, dust, etc.

#### Cleaning the camera surface

Clean the camera surface with a soft cloth slightly moistened with water, then wipe the surface with a dry cloth. Do not use the following as this may damage the finish or the casing.

- Thinner
- Benzine
- Alcohol
- Disposable cloth
- Volatile insecticide
- Contact with rubber or vinyl for a long time

### After getting the camera wet

- Wipe away any water droplets on the camera body with a clean, dry, soft cloth.
- Note that water remaining in the gaps on the camera body may get your clothes or the inside of your bag wet.
- In cold places, water droplets may freeze on the camera body. Note that using the camera with water droplets frozen on it may cause a malfunction.

### When sand, dirt or seawater adhere to the camera

If salt or other dirt is left encrusted on the camera, the metal portions may become damaged or rusted and result in water leaks. Follow the procedure below and clean the camera before opening the waterproof cover. Use tap water at 30°C or less to wash the camera.

- 1 Leave the camera immersed in a bucket or other container filled with fresh water.
- Wash the camera by gently moving it back and forth to thoroughly remove any dirt, sand and salt. Then, let it soak for approximately 30 minutes.
  - Do not rub the lens or the LCD screen when they are dirty as this may cause scratches.

## 2 Wipe the camera.

- Wipe away the water on the camera using a clean, dry, soft cloth, then leave the camera in the shade to dry.
- Water that is not completely wiped away may seep out later, so place the camera on a soft cloth.

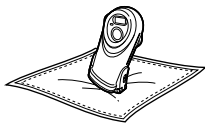

## Other precautions

- If there is mud on the O-ring, or if the camera has been in seawater, remove the O-ring to clean and inspect it (page 81).
- When sun oil or other oily substances adhere to the camera, wash the camera in tap water. Leaving these substances on the camera may cause surface discoloration or other damage.
- Do not wash the camera in a washing machine, etc.
- Do not swing the camera violently to shake off the water or forcibly dry the camera using a hair dryer, etc.
- When the O-ring or the O-ring mating surface is extremely dirty, consult your Sony dealer or local authorized Sony service facility.

## On storage

Avoid storage in hot, cold or humid places, or places exposed to naphthalene, camphor or other chemicals, as this may damage the camera.

## Note on operating temperature

Your camera is designed for use between the temperatures of 0°C and 40°C (32°F and 104°F). Shooting in extremely cold or hot places that exceed this range is not recommended.

## On moisture condensation

If the camera is brought directly from a cold to a warm location, or is placed in a very damp room, moisture may condense inside or outside the camera. Using the camera with water droplets inside may cause a malfunction of the camera.

## Moisture condensation occurs easily when:

- The camera is brought from a cold location such as a ski slope into a warmly heated room.
- The camera is taken from an air-conditioned room or car interior to the hot outdoors.
- The camera is brought suddenly from a damp, warm place to underwater, etc.

## How to prevent moisture condensation

When bringing the camera from a cold place to a warm place, seal the camera in a plastic bag and allow it to adapt to conditions at the new location over a period of time (about an hour).

## If moisture condensation occurs

Turn off the camera and wait about an hour with the waterproof cover and inner cover opened for the moisture to evaporate. Note that if you attempt to shoot with moisture remaining inside the lens, you will be unable to record clear images.

## On “Memory Stick”

### On internal rechargeable button battery

This camera has an internal rechargeable button battery for maintaining the date and time and other settings regardless of whether the power is on or off.

This rechargeable button battery is continually charged as long as you are using the camera. However, if you use the camera for only short periods it discharges gradually, and if you do not use the camera at all for about one month it becomes completely discharged. In this case, be sure to charge this rechargeable button battery before using the camera.

However, even if this rechargeable button battery is not charged, you can still use the camera as long as you do not record the date and time.

### Charging method

Install charged size AAA Nickel-Metal Hydride batteries, and leave the camera for 24 hours or more with the power off.

“Memory Stick” is a new compact, portable and versatile IC recording medium with a data capacity that exceeds the capacity of a floppy disk.

In addition to exchanging data between “Memory Stick” compatible equipment, you can also use a “Memory Stick” to store data as a type of detachable external recording media.

There are two types of “Memory Stick”: ordinary “Memory Stick” and “MagicGate Memory Stick” that is equipped with the MagicGate\* copyright protection technology. You can use both types of “Memory Stick” with your camera.

However, because your camera does not support the MagicGate standards, data recorded with your camera is not subject to MagicGate copyright protection.

In addition, you can also use “Memory Stick Duo” or “Memory Stick PRO” with your camera.

- \* MagicGate is copyright protection technology that uses encryption technology.
- “Memory Stick” formatted with a computer is not guaranteed to operate with this camera.

“Memory Stick” type	Recording/ Playback
Memory Stick (Memory Stick Duo)	○
MagicGate Memory Stick (MagicGate Memory Stick Duo)	○**
Memory Stick PRO	○**

\*\* The camera cannot record or play back the data needed by the MagicGate function. All “Memory Stick” media operations are not necessarily guaranteed.

### Notes on using the supplied “Memory Stick”

- You cannot record, edit or delete images when the write-protect switch is set to LOCK. The position or the shape of the write-protect switch may differ depending on the “Memory Stick” you use.

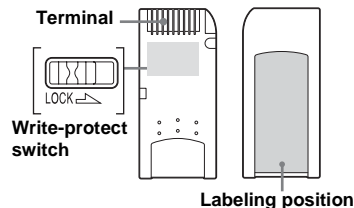

- Do not remove the “Memory Stick” while reading or writing data.
- Data may be corrupted in the following cases.
  - When the “Memory Stick” is removed or the camera is turned off during read or write operation
  - When the “Memory Stick” is used in locations subject to static electricity or electrical noise
- We recommend backing up important data.
- Do not attach any other material than the supplied label on the labeling position.
- Attach the label in the prescribed label location, taking care that the label does not extend from this location.
- When you carry or store the “Memory Stick,” put it in the case supplied with it.
- Do not touch the terminal of the “Memory Stick” with your hand or a metal object.
- Do not strike, bend or drop the “Memory Stick.”
- Do not disassemble or modify the “Memory Stick.”
- Do not expose the “Memory Stick” to water.
- Do not use or keep the “Memory Stick” under the following conditions:
  - High temperature locations such as the hot interior of a car parked in direct sunlight
  - Locations exposed to direct sunlight
  - Humid locations or locations with corrosive substances

## Notes on using “Memory Stick Duo” (not supplied)

- When using a “Memory Stick Duo” with your camera, be sure to insert the “Memory Stick Duo” into a Memory Stick Duo adaptor.
- When inserting a “Memory Stick Duo” into a Memory Stick Duo adaptor, make sure the “Memory Stick Duo” is inserted facing the correct direction.
- When using a “Memory Stick Duo” inserted into a Memory Stick Duo adaptor with this camera, make sure that the “Memory Stick Duo” is inserted facing the correct direction. Note that improper use may damage the equipment.
- Do not insert a “Memory Stick Duo” without a Memory Stick Duo adaptor into “Memory Stick” compatible equipment, as this may cause equipment trouble.

## Note on using “Memory Stick PRO” (not supplied)

- “Memory Stick PRO” with a capacity up to 1GB have been confirmed to operate properly with this camera.

## *On Nickel-Metal Hydride batteries*

### **Effective use of the battery**

- Battery performance decreases in low-temperature surroundings, and the battery life is shortened under such circumstances. To use the battery longer, we recommend you keep the battery in its case in a pocket close to your body to warm it, and insert it in your camera just before you start shooting.
- If you set [LCD LIGHT] to [OFF], the battery will run for a longer amount of time.
- If you shoot a lot using the flash, the battery power will be used up faster.
- We recommend having spare batteries handy for two or three times the expected shooting time, and try test shooting before actually using the camera.
- Do not expose the battery to water. The battery is not water-resistant.

### **Battery life**

- The battery life is limited. The battery capacity decreases little by little as you use it more and more, and as time passes. When the battery operating time seems to have been considerably shortened, a probable cause is that the batteries have reached the end of their life.
- The battery life varies depending on storage, operating conditions, and environment, and is different for each battery.

## On the battery charger

- Do not charge any other batteries except Sony Nickel-Metal Hydride batteries in the battery charger supplied with your camera. If you try to charge any other type of battery (e.g., manganese batteries, alkaline dry cells, primary lithium batteries, or Ni-Cd batteries) than the batteries specified, those batteries may leak, overheat, or explode, causing the danger of burns or other injuries.
- Do not charge fully charged Nickel-Metal Hydride batteries again. Otherwise, there is a danger of leaks, excessive heat, explosions, or electric shock.
- When charging a high capacity battery other than the supplied battery using the supplied battery charger, the full capacity of the battery may not be available.
- When the CHARGE lamp flashes, this may indicate a battery error or that batteries other than the specified type have been inserted. Check that the batteries are the specified type. If the batteries are the specified type, remove all the batteries, replace them with new ones or another ones and check if the battery charger operates correctly. If the battery charger operates correctly, a battery error may have occurred.
- The battery charger is not waterproof. Do not allow the battery charger to become wet.

## On the O-ring

O-rings are a type of waterproof packing that is used in underwater cameras and watches, diving equipment, etc. This camera uses an O-ring in the waterproof cover portion.

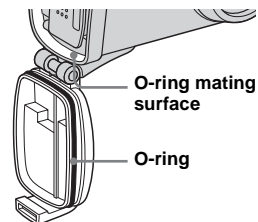

### Before use

Before using this camera underwater or in places exposed to water, be sure to inspect the O-ring and the O-ring mating surface. If the O-ring or the O-ring mating surface is cracked, scratched or otherwise damaged, or if sand particles, hair or other minute dirt has adhered, the waterproofing performance may be impaired. Note that water entering the inside of the camera may cause irreparable damage.

## Inspecting the O-ring and the O-ring mating surface

Inspect the O-ring and the O-ring mating surface in a location that is free from sand, dust or moisture.

### 1 Before opening the waterproof cover, rinse off any sand and completely wipe away any water that may be present on the camera body.

- Sand or water getting inside the camera may cause a malfunction.

### 2 Open the waterproof cover.

- For details on how to open and close the waterproof cover, see page 12.

### 3 Inspect the O-ring and the O-ring mating surface.

- Be sure to wipe away any dirt, sand particles, hair, dust, salt, lint or other foreign matter adhering to the O-ring with a soft, lint-free cloth. Even a single hair adhering to the O-ring may cause a water leak.

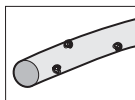

Dirt

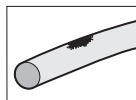

Sand

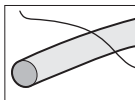

Hair

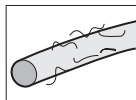

Dust

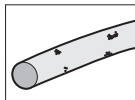

Salt

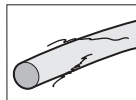

Lint

- Tiny dirt particles that are difficult to see may have adhered to the O-ring, so inspect the O-ring by running it through your fingers.
- When wiping away dirt from the O-ring, take care that cloth fibers do not remain on the O-ring.
- When it is difficult to wipe away the dirt from the O-ring, remove the O-ring and wash it with water.

- Be sure to replace the O-ring with a new one if it becomes cracked, warped, crushed, twisted, split, scratched, rough or otherwise damaged.

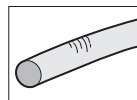

Crack

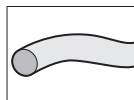

Warp

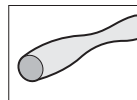

Crush

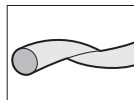

Twist

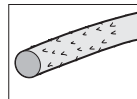

Split

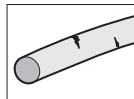

Scratch

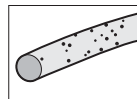

Rough

### 4 Close the waterproof cover.

### 5 Lock the lock switch.

## Removing/Setting the O-ring

When removing the O-ring for replacement, cleaning or inspection, take care for the following points.

If there is mud on the O-ring, or if the camera has been in seawater, be sure to remove the O-ring to clean and inspect it.

### Removing the O-ring

Press lightly on the O-ring with your fingers to shift it from the groove, grasp the slack portion, and remove the O-ring.

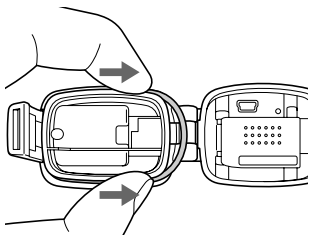

- Do not use a pointed, sharp or metal object to remove the O-ring. This can scratch the O-ring or the O-ring mating surface which may allow water to leak inside the camera.
- Do not place excessive tension on the O-ring.

### Cleaning the O-ring and the O-ring groove

- Use tap water at 30°C or less to wash the O-ring that you removed. Wipe away any water when finished.
- The O-ring is specially treated, so take care not to allow grease or oil to adhere to the O-ring.
- When sand particles or encrusted salt may be present in the O-ring groove, clean the groove carefully using a cotton swab. Take care that fibers from the cotton swab do not remain in the groove.
- Do not use a pointed, sharp or metal object for cleaning, as this may scratch the O-ring groove.

### Setting the O-ring

Place the O-ring in the groove, taking care for the following points.

- Do not place excessive tension on the O-ring.
- After setting, run a final check for any of the following problems.
  - Are there any water droplets on the O-ring?
  - Is the O-ring twisted?
  - Has any dirt, etc. adhered to the O-ring?
  - Is the O-ring protruding from the groove?

### O-ring life

- Replace the O-ring with a new one if it becomes cracked, warped, crushed, twisted, split, scratched, rough or otherwise damaged. Even if the O-ring has no problems, deformation and wear over time can cause the waterproof performance to drop, so replace the O-ring with a new one after approximately two years of use.
- Consult your Sony dealer or local authorized Sony service facility for replacement of O-rings. Order the following parts number when purchasing the O-ring:

3-081-956-□□

# Specifications

## ■ Camera

### [System]

#### Image device

6.72 mm (1/2.7 type) color CCD  
Primary color filter

#### Total pixels number of camera

Approx. 2 112 000 pixels

#### Effective pixels number of camera

Approx. 2 020 000 pixels

#### Lens

Single focal lens  
f = 5.0 mm (7/32 inches)  
(35 mm camera conversion: 33 mm  
(1 5/16 inches))  
F2.8

#### Exposure control

Automatic, Scene Selection  
(6 modes)

#### Data formats

Still images: DCF compliant  
(Exif Ver. 2.2 JPEG compliant),  
DPOF compatible  
Movies: MPEG1 compliant (without  
audio)

#### Recording media

"Memory Stick"

#### Flash

Recommended distance: 0.5 m to  
1.9 m (1 foot 7 3/4 inches to 6 feet  
2 3/4 inches)

### [Output connector]

**USB jack** mini-B

### [LCD screen]

#### LCD panel used

2.5 cm (1.0 type) TFT drive

#### Total number of dots

64 460 (293×220) dots

### [Power, general]

#### Used batteries

AAA Nickel-Metal Hydride  
batteries (2) 2.4 V  
5 V (from USB cable)

#### Power consumption (when shooting)

1.35 W

#### Operating temperature range

0°C to +40°C (+32°F to +104°F)

#### Storage temperature range

-20°C to +60°C (-4°F to +140°F)

#### Dimensions

60.2 × 116.8 × 43.3 mm  
(2 3/8 × 4 5/8 × 1 3/4 inches)  
(W/H/D, protruding portions not  
included)

#### Mass

Approx. 191 g (6.7 oz) (two  
batteries, "Memory Stick," and hand  
strap included)

#### Exif Print Compatible

#### PRINT Image Matching II Compatible

## ■ BC-CS2A/CS2B Ni-MH battery charger

### Input rating

100 –240V AC, 50/60Hz, 3W

### Output rating

DC OUT AA: 1.4V, 400 mA × 2  
AAA: 1.4V, 160 mA × 2

### Operating temperature range

0°C to +40°C (+32°F to +104°F)

### Storage temperature range

-20°C to +60°C (-4°F to +140°F)

### Dimensions

Approx. 71 × 30 × 91 mm  
(2 7/8 × 1 3/16 × 3 5/8 inches)  
(W/H/D)

### Mass

Approx. 90 g (3 oz)

## Accessories

- HR 11/45: HR03 (size AAA) Ni-MH batteries (2)
- Battery case (1)
- BC-CS2A/CS2B Ni-MH battery charger (1)
- Power cord (mains lead) (1)
- USB cable (1)
- Hand strap (1)
- "Memory Stick" (8MB) (1)
- CD-ROM (USB driver SPVD-010) (1)
- Operating instructions (1)

Design and specifications are subject to change without notice.

# LCD screen displays

## When shooting still images

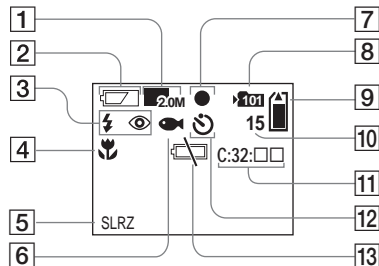

- 1 Image size indicator (20, 33)
- 2 Battery remaining indicator (14)
- 3 Flash mode indicator (25)/  
Red-eye reduction indicator (26)
- 4 Focus preset indicator (32)
- 5 Picture effect indicator (34)
- 6 Scene Selection indicator (30)
- 7 AE/AF lock indicator (22)
- 8 Recording folder indicator (26)
- 9 Remaining "Memory Stick"  
capacity indicator
- 10 Remaining number of recordable  
images indicator (21)
- 11 Self-diagnosis display (70)
- 12 Self-timer indicator (24)
- 13 Low battery warning indicator  
(68)

## When shooting movies

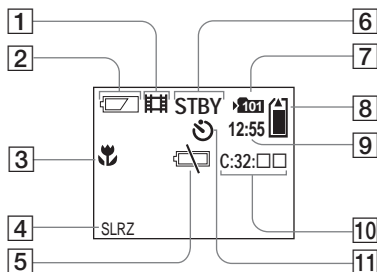

- 1 Recording mode indicator (43)
- 2 Battery remaining indicator (14)
- 3 Focus preset indicator (32)
- 4 Picture effect indicator (34)
- 5 Low battery warning indicator  
(68)
- 6 Status indicator (43)
- 7 Recording folder indicator (26)
- 8 Remaining "Memory Stick"  
capacity indicator
- 9 Recording time [maximum  
recordable time] indicator (44)
- 10 Self-diagnosis display (70)
- 11 Self-timer indicator (24)

Page numbers in parentheses indicate the location of additional important information.

## When playing back still images

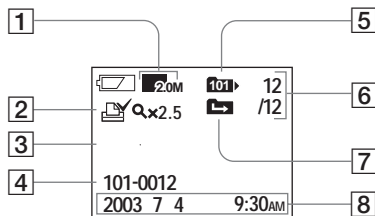

- 1** Image size indicator (20, 33)
- 2** Print (DPOF) mark indicator (41)
- 3** Enlarged playback/Enlargement level indicator (40)
- 4** Folder-file name (57)
- 5** Playback folder indicator (38)
- 6** Image number/Number of images recorded in selected folder
- 7** Change folder indicator (39)
- 8** Recording date/time of the playback image

## When playing back movies

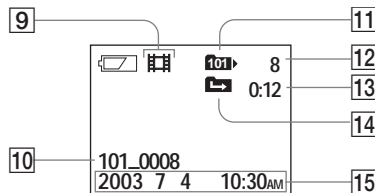

- 9** Recording mode indicator (44)
- 10** Folder\_file name (57)
- 11** Playback folder indicator (38)
- 12** Image number
- 13** Counter
- 14** Change folder indicator (39)
- 15** Recording date/time of the playback image

Page numbers in parentheses indicate the location of additional important information.

## A

Access lamp .....	19
AE/AF lock indicator .....	22
Auto adjustment mode .....	22
Auto Focus .....	23
Auto power-off function .....	15

## B

Battery	
battery life .....	14
charging time .....	11
preparing batteries .....	10
remaining indicator .....	14
Beep/shutter sound .....	73
Burst .....	33

## C

CD-ROM .....	49
Changing the recording folder .....	28
Charging	
batteries .....	10
charging time .....	11
Cleaning .....	74, 81
Clock set .....	16
Computer	
copying images .....	54, 59
Image Transfer .....	51
ImageMixer .....	52
USB cable .....	53
USB driver .....	50, 59
Control buttons .....	9, 16

Copying images .....	54, 59
Creating a new folder .....	27

## D

Deleting images .....	46
DPOF .....	41

## E

Enlarged playback .....	40
EXEC .....	16, 40
Exif .....	82

## F

File	
file names .....	57
image file storage destinations .....	57
Flash	
Red-eye reduction .....	25, 26
selecting a flash mode .....	25

## F

Focusing	
Focus preset .....	32
shooting (using auto adjustment mode) .....	22

## F

Folder	
changing the recording folder .....	28
creating a new folder .....	27
playback folder .....	38
recording folder .....	26

Formatting a “Memory Stick” .....	47
-----------------------------------	----

## I

Image	
copying images to your	
computer .....	54, 55, 59
file names .....	57
image file storage destinations .....	57
image size .....	20, 21
Image Transfer .....	51
ImageMixer .....	52
Index screen .....	36
Inner cover .....	12
Installation	
Image Transfer .....	51
ImageMixer .....	52
USB driver .....	50, 59

## J

JPG .....	57
-----------	----

## L

LCD screen	
LCD light .....	23
screen display .....	24, 83
Lock switch .....	9, 12

## M

Memory Stick	
formatting a “Memory Stick” .....	47
inserting/removing a “Memory Stick” .....	18
number of shooting images .....	21
shooting time .....	44

MENU .....	16
Menu settings .....	71
Mode switch .....	9, 20
Moisture condensation .....	75
Movie	
delete .....	46
shooting movies .....	43
shooting time .....	44
viewing images on your computer .....	56, 59
viewing movies on the LCD screen .....	44
MPG .....	57

## N

Nickel-Metal Hydride batteries .....	10, 78
--------------------------------------	--------

## O

O-ring	
inspecting the O-ring .....	80
removing/setting the O-ring .....	81

## P

Picture Effect .....	34
POWER .....	15
Power	
batteries .....	10
inserting the batteries .....	12
on/off .....	15
Precautions .....	74
Print (DPOF) mark .....	41

## R

Red-eye reduction .....	25, 26
RESET button .....	61, 70

## S

SCENE .....	31
Scene Selection (SCENE)	
Active outdoor mode .....	30
Illumination snap mode .....	30
Soft snap mode .....	30
Twilight mode .....	31
Underwater mode .....	30
Vivid nature mode .....	31
Self-diagnosis display .....	70
Self-timer .....	24
Setting	
date and time .....	16
image size .....	20
menu items .....	71
Shooting mode	
auto adjustment mode .....	22
Burst .....	33
movie .....	43
Shooting underwater .....	30
Single image screen .....	36
Still image shooting	
auto focus .....	22
image size .....	20, 21
number of images that can be saved .....	21
Picture Effect .....	34
Scene Selection .....	30
using auto adjustment mode .....	22
using the flash .....	25
using the self-timer .....	24

## Still image viewing

delete .....	46
index screen .....	37
single image screen .....	36
viewing images on your computer .....	56, 59
viewing still images on the LCD screen .....	36

## U

### USB

USB Bus Powered .....	49
USB cable .....	53, 54, 59
USB connection .....	53
USB driver .....	50, 59
Using your camera abroad .....	15

## V

Video CD .....	60
Viewing images on the LCD screen .....	36, 44
Viewing images on your computer .....	56, 59

## W

Warnings and messages .....	68
Waterproof cover .....	8, 12
Waterproof performance .....	4, 30



307872411

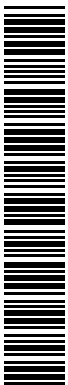

Printed on 100% recycled paper  
using VOC (Volatile Organic  
Compound)-free vegetable oil  
based ink.

<http://www.sony.net/>  
Sony Corporation Printed in Japan

Additional information on this product and answers to frequently  
asked questions can be found at our Customer Support Website.