

**ROG  
MAXIMUS X  
APEX**

**ASUS®**

**Motherboard**

**Copyright © 2017 ASUSTeK COMPUTER INC. All Rights Reserved.**

No part of this manual, including the products and software described in it, may be reproduced, transmitted, transcribed, stored in a retrieval system, or translated into any language in any form or by any means, except documentation kept by the purchaser for backup purposes, without the express written permission of ASUSTeK COMPUTER INC. ("ASUS").

Product warranty or service will not be extended if: (1) the product is repaired, modified or altered, unless such repair, modification or alteration is authorized in writing by ASUS; or (2) the serial number of the product is defaced or missing.

ASUS PROVIDES THIS MANUAL "AS IS" WITHOUT WARRANTY OF ANY KIND, EITHER EXPRESS OR IMPLIED, INCLUDING BUT NOT LIMITED TO THE IMPLIED WARRANTIES OR CONDITIONS OF MERCHANTABILITY OR FITNESS FOR A PARTICULAR PURPOSE. IN NO EVENT SHALL ASUS, ITS DIRECTORS, OFFICERS, EMPLOYEES OR AGENTS BE LIABLE FOR ANY INDIRECT, SPECIAL, INCIDENTAL, OR CONSEQUENTIAL DAMAGES (INCLUDING DAMAGES FOR LOSS OF PROFITS, LOSS OF BUSINESS, LOSS OF USE OR DATA, INTERRUPTION OF BUSINESS AND THE LIKE), EVEN IF ASUS HAS BEEN ADVISED OF THE POSSIBILITY OF SUCH DAMAGES ARISING FROM ANY DEFECT OR ERROR IN THIS MANUAL OR PRODUCT.

SPECIFICATIONS AND INFORMATION CONTAINED IN THIS MANUAL ARE FURNISHED FOR INFORMATIONAL USE ONLY, AND ARE SUBJECT TO CHANGE AT ANY TIME WITHOUT NOTICE, AND SHOULD NOT BE CONSTRUED AS A COMMITMENT BY ASUS. ASUS ASSUMES NO RESPONSIBILITY OR LIABILITY FOR ANY ERRORS OR INACCURACIES THAT MAY APPEAR IN THIS MANUAL, INCLUDING THE PRODUCTS AND SOFTWARE DESCRIBED IN IT.

Products and corporate names appearing in this manual may or may not be registered trademarks or copyrights of their respective companies, and are used only for identification or explanation and to the owners' benefit, without intent to infringe.

**Offer to Provide Source Code of Certain Software**

This product contains copyrighted software that is licensed under the General Public License ("GPL"), under the Lesser General Public License Version ("LGPL") and/or other Free Open Source Software Licenses. Such software in this product is distributed without any warranty to the extent permitted by the applicable law. Copies of these licenses are included in this product.

Where the applicable license entitles you to the source code of such software and/or other additional data, you may obtain it for a period of three years after our last shipment of the product, either

(1) for free by downloading it from <https://www.asus.com/support/>

or

(2) for the cost of reproduction and shipment, which is dependent on the preferred carrier and the location where you want to have it shipped to, by sending a request to:

ASUSTeK Computer Inc.  
Legal Compliance Dept.  
15 Li Te Rd.,  
Beitou, Taipei 112  
Taiwan

In your request please provide the name, model number and version, as stated in the About Box of the product for which you wish to obtain the corresponding source code and your contact details so that we can coordinate the terms and cost of shipment with you.

The source code will be distributed WITHOUT ANY WARRANTY and licensed under the same license as the corresponding binary/object code.

This offer is valid to anyone in receipt of this information.

ASUSTeK is eager to duly provide complete source code as required under various Free Open Source Software licenses. If however you encounter any problems in obtaining the full corresponding source code we would be much obliged if you give us a notification to the email address [gpl@asus.com](mailto:gpl@asus.com), stating the product and describing the problem (please DO NOT send large attachments such as source code archives, etc. to this email address).

# Contents

Safety information.....	vi
About this guide.....	vii
ROG MAXIMUS X APEX specifications summary.....	ix
Package contents.....	xiv
Installation tools and components.....	xv

## Chapter 1: Product Introduction

<b>1.1</b>	<b>Motherboard overview.....</b>	<b>1-1</b>
1.1.1	Before you proceed.....	1-1
1.1.2	Motherboard layout.....	1-2
1.1.3	Central Processing Unit (CPU).....	1-4
1.1.4	System memory.....	1-5
1.1.5	Expansion slots.....	1-7
1.1.6	Onboard buttons and switches.....	1-9
1.1.7	Jumper.....	1-15
1.1.8	Onboard LEDs.....	1-17
1.1.9	Internal connectors.....	1-19
1.1.10	Probelt.....	1-30

## Chapter 2: Basic Installation

<b>2.1</b>	<b>Building your PC system.....</b>	<b>2-1</b>
2.1.1	CPU installation.....	2-1
2.1.2	Cooling system installation.....	2-3
2.1.3	Motherboard installation.....	2-6
2.1.4	DIMM installation.....	2-7
2.1.5	ATX power connection.....	2-8
2.1.6	SATA device connection.....	2-8
2.1.7	Front I/O connector.....	2-9
2.1.8	Expansion card installation.....	2-10
2.1.9	Fan bracket installation.....	2-11
<b>2.2</b>	<b>BIOS update utility.....</b>	<b>2-12</b>
<b>2.3</b>	<b>Motherboard rear and audio connections.....</b>	<b>2-13</b>
2.3.1	Rear I/O connection.....	2-13
2.3.2	Audio I/O connections.....	2-15
<b>2.4</b>	<b>Starting up for the first time.....</b>	<b>2-17</b>
<b>2.5</b>	<b>Turning off the computer.....</b>	<b>2-17</b>

## **Chapter 3: BIOS Setup**

<b>3.1</b>	<b>Knowing BIOS</b> .....	<b>3-1</b>
<b>3.2</b>	<b>BIOS setup program</b> .....	<b>3-2</b>
	3.2.1 Advanced Mode .....	3-3
	3.2.2 EZ Mode.....	3-6
	3.2.3 Q-Fan Control .....	3-7
	3.2.4 EZ Tuning Wizard .....	3-9
<b>3.3</b>	<b>My Favorites</b> .....	<b>3-12</b>
<b>3.4</b>	<b>Main menu</b> .....	<b>3-14</b>
<b>3.5</b>	<b>Extreme Tweaker menu</b> .....	<b>3-14</b>
<b>3.6</b>	<b>Advanced menu</b> .....	<b>3-16</b>
	3.6.1 CPU Configuration .....	3-16
	3.6.2 Platform Misc Configuration.....	3-16
	3.6.3 System Agent (SA) Configuration .....	3-16
	3.6.4 PCH Configuration .....	3-16
	3.6.5 PCH Storage Configuration.....	3-17
	3.6.6 PCH-FW Configuration .....	3-17
	3.6.7 ROG Effects.....	3-18
	3.6.8 Onboard Devices Configuration.....	3-18
	3.6.9 APM Configuration.....	3-19
	3.6.10 Network Stack Configuration.....	3-19
	3.6.11 HDD/SSD SMART Information .....	3-19
	3.6.12 USB Configuration .....	3-19
<b>3.7</b>	<b>Monitor menu</b> .....	<b>3-20</b>
<b>3.8</b>	<b>Boot menu</b> .....	<b>3-20</b>
<b>3.9</b>	<b>Tool menu</b> .....	<b>3-22</b>
	3.9.1 ASUS EZ Flash 3 Utility .....	3-22
	3.9.2 Secure Erase .....	3-23
	3.9.3 ASUS Overclocking Profile .....	3-24
	3.9.4 BIOS FlashBack.....	3-24
	3.9.5 ROG OC Panel H-Key Configure.....	3-24
	3.9.6 ASUS SPD Information.....	3-25
	3.9.7 Graphics Card Information.....	3-25
<b>3.10</b>	<b>Exit menu</b> .....	<b>3-25</b>
<b>3.11</b>	<b>Updating BIOS</b> .....	<b>3-26</b>
	3.11.1 EZ Update.....	3-26
	3.11.2 ASUS EZ Flash 3.....	3-27
	3.11.3 ASUS CrashFree BIOS 3.....	3-29

## **Chapter 4: RAID Support**

<b>4.1</b>	<b>RAID configurations</b> .....	<b>4-1</b>
4.1.1	RAID definitions .....	4-1
4.1.2	Installing Serial ATA hard disks .....	4-2
4.1.3	Intel® Rapid Storage Technology in UEFI BIOS.....	4-2
4.1.4	Intel® Rapid Storage Technology Option ROM utility.....	4-6
<b>4.2</b>	<b>Creating a RAID driver disk</b> .....	<b>4-10</b>
4.2.1	Creating a RAID driver disk in Windows® .....	4-10

## **Appendix**

<b>Q-Code table</b> .....	<b>A-1</b>
<b>Notices</b> .....	<b>A-5</b>
<b>ASUS contact information</b> .....	<b>A-9</b>

# Safety information

## Electrical safety

- To prevent electrical shock hazard, disconnect the power cable from the electrical outlet before relocating the system.
- When adding or removing devices to or from the system, ensure that the power cables for the devices are unplugged before the signal cables are connected. If possible, disconnect all power cables from the existing system before you add a device.
- Before connecting or removing signal cables from the motherboard, ensure that all power cables are unplugged.
- Seek professional assistance before using an adapter or extension cord. These devices could interrupt the grounding circuit.
- Ensure that your power supply is set to the correct voltage in your area. If you are not sure about the voltage of the electrical outlet you are using, contact your local power company.
- If the power supply is broken, do not try to fix it by yourself. Contact a qualified service technician or your retailer.

## Operation safety

- Before installing the motherboard and adding devices on it, carefully read all the manuals that came with the package.
- Before using the product, ensure all cables are correctly connected and the power cables are not damaged. If you detect any damage, contact your dealer immediately.
- To avoid short circuits, keep paper clips, screws, and staples away from connectors, slots, sockets and circuitry.
- Avoid dust, humidity, and temperature extremes. Do not place the product in any area where it may become wet.
- Place the product on a stable surface.
- If you encounter technical problems with the product, contact a qualified service technician or your retailer.

## About this guide

This user guide contains the information you need when installing and configuring the motherboard.

## How this guide is organized

This guide contains the following parts:

- **Chapter 1: Product Introduction**  
This chapter describes the features of the motherboard and the new technology it supports. It includes description of the switches, jumpers, and connectors on the motherboard.
- **Chapter 2: Basic Installation**  
This chapter lists the hardware setup procedures that you have to perform when installing system components.
- **Chapter 3: BIOS Setup**  
This chapter tells how to change system settings through the BIOS Setup menus. Detailed descriptions of the BIOS parameters are also provided.
- **Chapter 4: RAID Support**  
This chapter describes the RAID configurations.

## Where to find more information

Refer to the following sources for additional information and for product and software updates.

1. **ASUS website**  
The ASUS website ([www.asus.com](http://www.asus.com)) provides updated information on ASUS hardware and software products.
2. **Optional documentation**  
Your product package may include optional documentation, such as warranty flyers, that may have been added by your dealer. These documents are not part of the standard package.

## Conventions used in this guide

To ensure that you perform certain tasks properly, take note of the following symbols used throughout this manual.



**DANGER/WARNING:** Information to prevent injury to yourself when trying to complete a task.



**CAUTION:** Information to prevent damage to the components when trying to complete a task.



**IMPORTANT:** Instructions that you **MUST** follow to complete a task.



**NOTE:** Tips and additional information to help you complete a task.

## Typography

**Bold text**

Indicates a menu or an item to select.

*Italics*

Used to emphasize a word or a phrase.

<Key>

Keys enclosed in the less-than and greater-than sign means that you must press the enclosed key.

Example: <Enter> means that you must press the Enter or Return key.

<Key1> + <Key2> + <Key3>

If you must press two or more keys simultaneously, the key names are linked with a plus sign (+).

## ROG MAXIMUS X APEX specifications summary

CPU	<p>Intel® Socket 1151 for 8th generation Core™ i7/Core™ i5/Core™ i3/Pentium®/Celeron® Processors</p> <p>Supports 14nm CPU</p> <p>Supports Intel® Turbo Boost Technology 2.0*</p> <p>* Intel® Turbo Boost Technology 2.0 support depends on the CPU type. Please refer to <a href="http://www.asus.com">www.asus.com</a> for Intel® CPU support list</p>
Chipset	Intel® Z370 Chipset
Memory	<p>2 x DIMM, max. 32GB DDR4 4266+(OC)* / 4133+(OC)* / 4000(OC)* / 3866(OC)* / 3733(OC)* / 3600(OC)* / 3466(OC)* / 3400(OC)* / 3333(OC)* / 3300(OC)* / 3200(OC)* / 3000(OC)* / 2800(OC)* / 2666(OC)* / 2400(OC)* / 2133 MHz, non-ECC, un-buffered memory</p> <p>Dual channel memory architecture</p> <p>Supports Intel® Extreme Memory Profile (XMP)</p> <p>* Hyper DIMM support is subject to the physical characteristics of individual CPUs. Please refer to <a href="http://www.asus.com">www.asus.com</a> for Memory QVL (Qualified Vendors List)</p>
Expansion slots	<p><b>New 8th Gen Intel® Core™ Processors</b></p> <p>2 x PCIe 3.0 x16 Safeslots (supports x16, x8/x8)</p> <p>1 x PCIe 3.0 x 16 Safeslot (max. at x8/x4 mode)</p> <p><b>Intel® Z370 Express Chipset</b></p> <p>1 x PCIe 3.0 x16 slot (max. at x4 mode)</p> <p>2 x PCIe 3.0 x1 slots</p>
Graphic	<p>Integrated Graphics Processor- Intel® HD Graphics support</p> <p>Multi-VGA output support : HDMI/DisplayPort</p> <ul style="list-style-type: none"> <li>- Supports DisplayPort 1.2 with max. resolution 4096 x 2304 @ 60Hz</li> <li>- Supports HDMI 1.4b with max. resolution 4096 x 2160 @ 30Hz</li> </ul> <p>Maximum shared memory of 1024MB</p>
Storage	<p><b>Intel® Z370 Express Chipset with RAID 0, 1, 5, 10, and Intel Rapid Storage Technology 15 support</b></p> <p><b>ROG DIMM.2 Ext. Card</b></p> <ul style="list-style-type: none"> <li>- 1 x M.2_1 Socket 3 with M Key, type 2230 / 2242 / 2260 / 2280 / 22110 (supports PCIE 3.0 x4 and SATA modes)</li> <li>- 1 x M.2_2 Socket 3 with M Key, type 2230 / 2242 / 2260 / 2280 / 22110 (supports PCIE 3.0 x4 mode)</li> </ul> <p>4 x SATA 6Gb/s ports</p> <ul style="list-style-type: none"> <li>- Supports Intel® Smart Response Technology*</li> <li>- Ready for Intel® Optane™ Memory**</li> </ul> <p>* This function will work depending on the CPU installed.</p> <p>** Intel® Optane™ Technology is only supported when using 8th Generation Intel® Processors. Before using Intel® Optane™ memory modules, ensure that you have updated your motherboard drivers and BIOS to the latest version from ASUS support website.</p>

(continued on the next page)

## ROG MAXIMUS X APEX specifications summary

LAN	<p>Aquantia AQC-108 5G LAN</p> <p>Intel® I219-V Gigabit LAN- Dual interconnect between the integrated Media Access Controller (MAC) and physical layer (PHY)</p> <p>Anti-surge LANGuard</p>
Multi-GPU support	<p>Supports NVIDIA® 2-Way/Quad-GPU SLI™ Technology</p> <p>Supports AMD® 4-Way/Quad-GPU CrossFireX™ Technology</p>
Audio	<p><b>ROG SupremeFX S1220A Codec</b></p> <ul style="list-style-type: none"> <li>- Supports up to 32-Bit/192kHz playback*</li> <li>- Impedance sense for front and rear headphone outputs</li> <li>- Jack-detection, Multi-streaming, and Front Panel Jack-retasking</li> <li>- Optical S/PDIF out port at back panel</li> </ul> <p>* Due to limitations in HDA bandwidth, 32-Bit/192kHz is not supported for 8-channel audio.</p>
USB	<p><b>Intel® Z370 Express Chipset:</b></p> <ul style="list-style-type: none"> <li>- 8 x USB 3.1 Gen 1 ports ( 2 ports at mid-board [grey])</li> <li>- 6 x USB 2.0 ports (6 ports at mid-board [black])*</li> </ul> <p><b>ASMedia® USB 3.1 controller</b></p> <ul style="list-style-type: none"> <li>- 2 x USB 3.1 Gen 2 ports ( 1 Type-A [red] and 1 Type-C™ [black] at back panel)</li> </ul> <p>* 2 x USB 2.0 ports at mid-board share with ROG extension (ROG_EXT) port.</p>
Back I/O Ports	<p>1 x Clear CMOS Button</p> <p>1 x BIOS Flashback Button</p> <p>1 x PS/2 Keyboard port</p> <p>1 x PS/2 Mouse port</p> <p>1 x HDMI 1.4b</p> <p>1 x DisplayPort 1.2</p> <p>6 x USB 3.1 Gen1 ports [blue]</p> <p>1 x Anti-surge 5G LAN (RJ45) port</p> <p>1 x Anti-surge LAN (RJ45) port</p> <p>2 x USB 3.1 Gen 2 ports (1 x Type-A [red] and 1 x Type-C [black])</p> <p>1 x Optical S/PDIF out</p> <p>5 x Gold-plated audio jacks</p>

*(continued on the next page)*

## ROG MAXIMUS X APEX specifications summary

### Internal I/O Ports

- 1 x USB 3.1 Gen 1 header support additional 2 x USB 3.1 Gen 1 ports
- 3 x USB 2.0 headers support additional 6 x USB 2.0 ports [one connector via ROG\_EXT header]
- 4 x SATA 6Gb/s ports
- 1 x DIMM.2 slot
- 1 x ROG extension (ROG\_EXT) header
- 1 x 4-Pin CPU fan connector
- 1 x 4-Pin CPU\_OPT fan connector
- 3 x 4-Pin Chassis fan connectors
- 1 x 4-Pin Water\_pump+ connector
- 1 x 4-Pin AIO\_Pump connector
- 2 x Thermal sensor connectors
- 3 x 4-Pin Full speed fan connectors (FS\_FAN)
- 1 x 24-Pin EATX power connector
- 2 x 8-Pin EATX 12V power connectors
- 1 x W\_IN header
- 1 x W\_OUT header
- 1 x W\_FLOW header
- 1 x Start button
- 1 x Reset button
- 1 x LN2 mode jumper
- 1 x MemOK! Button
- 4 x Aura RGB headers
- 1 x Front panel audio connector (AAFP)
- 1 x TPM connector
- 1 x BIOS switch button
- 1 x Slow mode Switch
- 1 x PCIe x16 Lane Switch
- 9 x Probelts measurement points
- 1 x EZ Plug connector
- 1 x Pause Switch
- 3 x LED ON/OFF headers (M.2\_LIGHT, LIGHT\_BAR1, LIGHT\_BAR2)
- 1 x System panel connector

*(continued on the next page)*

## ROG MAXIMUS X APEX specifications summary

<b>Software</b>	Drivers AURA ROG RAMDisk ROG RAMCache II ROG CPU-Z ROG Mem Tweakt Overwolf CloneDrive Kaspersky® Anti-Virus DAEMON Tools Software Winzip ASUS Utilities Fan Xpert 4
<b>ROG Exclusive Features</b>	<b>Extreme Engine Digi+</b> <ul style="list-style-type: none"><li>- MicroFine Alloy Choke</li><li>- NexFET MOSFETs</li><li>- 10K Black Metallic Capacitors</li></ul> <b>Codensation detection circuit</b> <b>ROG DIMM.2 extension card with two M.2 slots</b> <b>ROG APEX FAN BRACKET</b> <b>Probelt</b> <b>Start Button</b> <b>Reset Button</b> <b>ReTry Button</b> <b>Safe Boot Button</b> <b>Clear CMOS Button</b> <b>MemOK! Button</b> <b>LN2 Mode Jumper</b> <b>Slow Mode Switch</b> <b>Pause Switch</b> <b>ROG RAMDisk</b> <b>ROG RAMCache II</b> <b>UEFI BIOS features :</b> <ul style="list-style-type: none"><li>- Extreme Tweaker</li><li>- Tweakers' Paradise</li><li>- ROG SSD Secure Erase</li><li>- GPU Post</li><li>- O.C. Profile</li><li>- Graphics Card Information Preview</li></ul>

*(continued on the next page)*

# ROG MAXIMUS X APEX specifications summary

<p><b>Special Features</b></p>	<p><b>ASUS Dual Intelligent Processors 5</b></p> <ul style="list-style-type: none"> <li>- 5-Way Optimization tuning key perfectly consolidates TPU, EPU, DIGI+ Power Control, Fan Xpert 4, and Turbo App</li> </ul> <p><b>ASUS Exclusive Features</b></p> <ul style="list-style-type: none"> <li>- AI Suite 3</li> <li>- 3D Printing Friendly design</li> </ul> <p><b>ASUS EZ DIY</b></p> <ul style="list-style-type: none"> <li>- USB BIOS Flashback</li> <li>- ASUS CrashFree BIOS 3</li> <li>- ASUS EZ Flash 3</li> <li>- ASUS C.P.R.(CPU Parameter Recall)</li> <li>- MemOK!</li> </ul> <p><b>ASUS Q-Design</b></p> <ul style="list-style-type: none"> <li>- Q-Code</li> <li>- Q-Shield</li> <li>- Q-Connector</li> <li>- Q-LED (CPU[red], DRAM[yellow], VGA[white], Boot Device LED[green])</li> <li>- Safeslot</li> <li>- SafeDIMM slot</li> </ul>
<p><b>BIOS</b></p>	<p>2 x 128 Mb Flash ROM, UEFI AMI BIOS, PnP, DMI3.0, WfM2.0, SM BIOS 3.0, ACPI 6.0, Multi-language BIOS, ASUS EZ Flash 3, CrashFree BIOS 3, F11 EZ Tuning Wizard, F6 Qfan Control, F3 My Favorites, Last Modified log, F12 PrintScreen, F3 Shortcut functions and ASUS DRAM SPD (Serial Presence Detect) memory information.</p>
<p><b>Manageability</b></p>	<p>WfM2.0, DMI3.0, WOL by PME, PXE</p>
<p><b>Operating System Support</b></p>	<p>Windows® 10 64-bit</p>
<p><b>Form Factor</b></p>	<p>EATX Form Factor, 12"x 9.6" (30.5cm x 27.2cm) X-SHAPED PCB</p>



Specifications are subject to change without notice.

## Package contents



Check your motherboard package for the following items.

Motherboard	1 x ROG MAXIMUS X APEX motherboard
Cables	2 x 2-in-1 SATA 6Gb/s cables 1 x RGB LED extension cable
Accessories	1 x ROG DIMM.2 FAN bracket pack 1 x ROG APEX FAN bracket pack 1 x SLI™ HB Bridge(2-way-L) 1 x Q-Connector 1 x ROG Coaster 1 x CPU Installation Tool 2 x 1-in-1 M.2 Screw set 1 x ROG big sticker
Application DVD	1 x ROG motherboard support DVD
Documentation	1 x User guide

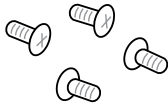

If any of the above items is damaged or missing, contact your retailer.

## Installation tools and components

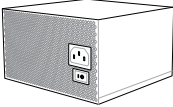
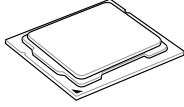
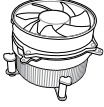
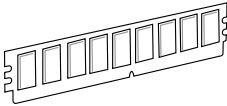
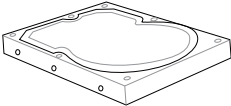
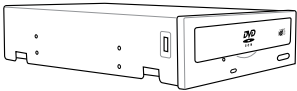
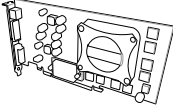
	
<b>1 Bag of screws</b>	<b>Phillips (cross) screwdriver</b>
	
<b>PC chassis</b>	<b>Power supply unit</b>
	
<b>Intel® LGA 1151 CPU</b>	<b>Intel® LGA 1151 compatible CPU Fan</b>
	
<b>DDR4 DIMM</b>	<b>SATA hard disk drive</b>
	
<b>SATA optical disc drive (optional)</b>	<b>Graphics card (optional)</b>



The tools and components in the table above are not included in the motherboard package.



# Product Introduction

# 1

## 1.1 Motherboard overview

### 1.1.1 Before you proceed

Take note of the following precautions before you install motherboard components or change any motherboard settings.



- 
- Unplug the power cord from the wall socket before touching any component.
  - Before handling components, use a grounded wrist strap or touch a safely grounded object or a metal object, such as the power supply case, to avoid damaging them due to static electricity.
  - Hold components by the edges to avoid touching the ICs on them.
  - Whenever you uninstall any component, place it on a grounded antistatic pad or in the bag that came with the component.
  - Before you install or remove any component, ensure that the ATX power supply is switched off or the power cord is detached from the power supply. Failure to do so may cause severe damage to the motherboard, peripherals, or components.
-

## 1.1.2 Motherboard layout

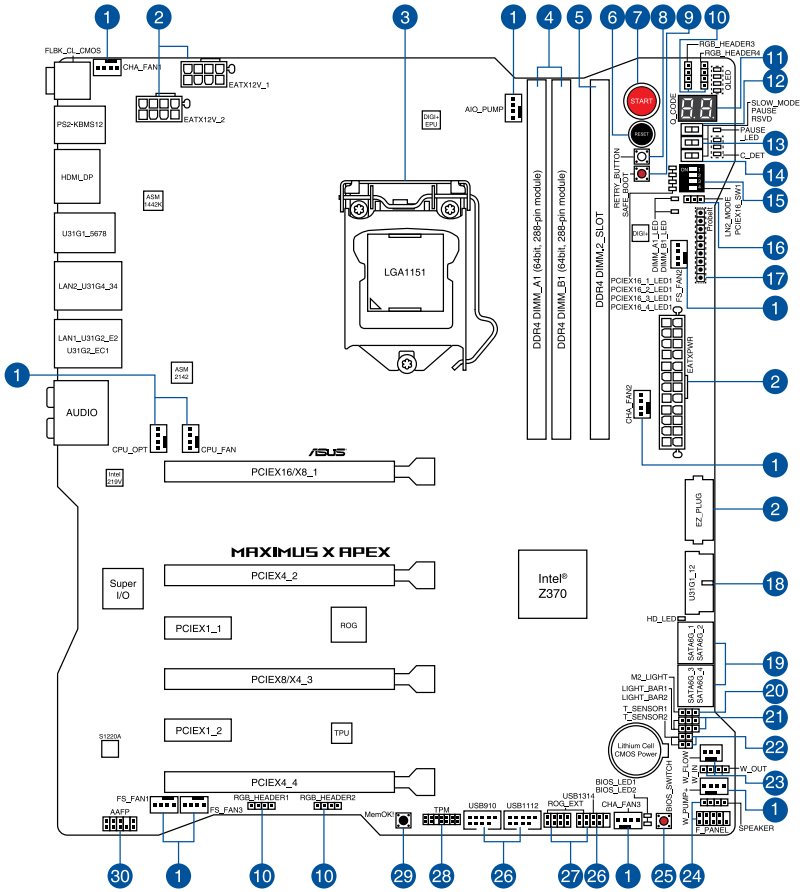

Refer to 1.1.9 Internal connectors and 2.3.1 Rear I/O connection for more information about rear panel connectors and internal connectors.

## Layout contents

Connectors/Jumpers/Buttons and switches/Slots	Page
1. CPU, CPU optional, full speed, and chassis fan connectors; water pump+, and AIO pump connectors (4-pin CPU_FAN; 4-pin CPU_OPT; 4-pin FS_FAN1-3; 4-pin W_PUMP+; 4-pin AIO_PUMP; 4-pin CHA_FAN1-3)	1-22
2. ATX power connectors (24-pin EATXPWR; 8-pin EATX12V_1; 8-pin EATX12V_2; 4-pin EZ_PLUG)	1-25
3. LGA1151 CPU Socket	1-4
4. DDR4 DIMM slots	1-5
5. DIMM.2 slot (DIMM.2_SLOT)	1-28
6. RESET button (RESET)	1-9
7. Power-on button (START)	1-9
8. ReTry button (RETRY_BUTTON)	1-12
9. Safe Boot button (SAFE_BOOT)	1-11
10. AURA RGB headers (4-pin RGB_HEADER1-4)	1-27
11. Q-Code LED	1-18
12. Slow Mode switch (SLOW_MODE)	1-11
13. Pause switch (PAUSE)	1-13
14. RSVD switch (RSVD)	1-14
15. PCIe x16 Lane switch (PCIEX16_SW1)	1-13
16. LN2 Mode jumper (3-pin LN2_MODE)	1-15
17. Probelt	1-30
18. USB 3.1 Gen 1 connector (20-1 pin U3G1_12)	1-20
19. Intel® Z370 Serial ATA 6 Gb/s connectors (7-pin SATA6G_12; SATA6G_34)	1-19
20. M.2 light jumper (3-pin M.2_LIGHT)	1-15
21. Light bar jumpers (3-pin LIGHT_BAR1-2)	1-16
22. Thermal sensor connectors (2-pin T_SENSOR1-2)	1-20
23. Water in, water out, and water flow connectors (2-pin W_IN; 2-pin W_OUT; 3-pin W_FLOW)	1-29
24. System panel connectors (10-1 pin F_PANEL; 4-pin SPEAKER)	1-26
25. BIOS Switch button (BIOS_SWITCH)	1-12
26. USB 2.0 connectors (10-1 pin USB910; USB1112; USB1314)	1-21
27. ROG Extension connector (18-1 pin ROG_EXT)	1-24
28. TPM connector (14-1 pin TPM)	1-29
29. MemOK! button (MemOK!)	1-10
30. Front panel audio connector (10-1 pin AAFP)	1-24

### 1.1.3 Central Processing Unit (CPU)

The motherboard comes with a surface mount LGA1151 socket designed for the 8th Generation Intel® Core™ i7 / Intel® Core™ i5 / Intel® Core™ i3, Pentium®, and Celeron® processors.

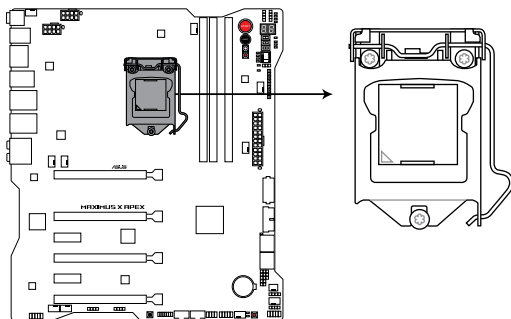

**ROG MAXIMUS X APEX CPU LGA1151**



---

Ensure that you install the correct CPU designed for LGA1151 socket only. **DO NOT** install a CPU designed for LGA1150, LGA1155 and LGA1156 sockets in the LGA1151 socket.

---



- Ensure that all power cables are unplugged before installing the CPU.
  - Upon purchase of the motherboard, ensure that the PnP cap is on the socket and the socket contacts are not bent. Contact your retailer immediately if the PnP cap is missing, or if you see any damage to the PnP cap/socket contacts/motherboard components. ASUS will shoulder the cost of repair only if the damage is shipment/transit-related.
  - Keep the cap after installing the motherboard. ASUS will process Return Merchandise Authorization (RMA) requests only if the motherboard comes with the cap on the LGA1151 socket.
  - The product warranty does not cover damage to the socket contacts resulting from incorrect CPU installation/removal, or misplacement/loss/incorrect removal of the PnP cap.
-

## 1.1.4 System memory

The motherboard comes with two (2) Double Data Rate 4 (DDR4) Dual Inline Memory Modules (DIMM) slots.



A DDR4 module is notched differently from a DDR, DDR2, or DDR3 module. DO NOT install a DDR, DDR2, or DDR3 memory module to the DDR4 slot.

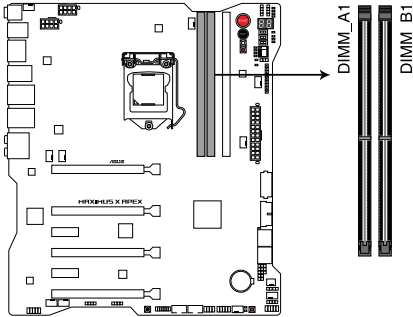

ROG MAXIMUS X APEX 288-pin DDR4 DIMM socket

### Recommended memory configurations

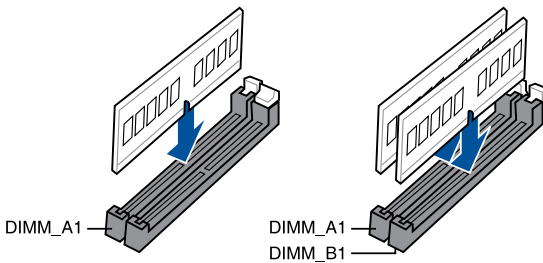

## Memory configurations

You may install 2 GB, 4 GB, 8 GB, and 16 GB unbuffered and non-ECC DDR4 DIMMs into the DIMM sockets.



---

You may install varying memory sizes in Channel A and Channel B. The system maps the total size of the lower-sized channel for the dual-channel configuration. Any excess memory from the higher-sized channel is then mapped for single-channel operation.

---



- The default memory operation frequency is dependent on its Serial Presence Detect (SPD), which is the standard way of accessing information from a memory module. Under the default state, some memory modules for overclocking may operate at a lower frequency than the vendor-marked value.
  - For system stability, use a more efficient memory cooling system to support a full memory load (2 DIMMs) or overclocking condition.
  - Always install the DIMMS with the same CAS Latency. For an optimum compatibility, we recommend that you install memory modules of the same version or data code (D/C) from the same vendor. Check with the vendor to get the correct memory modules.
-

## 1.1.5 Expansion slots



Unplug the power cord before adding or removing expansion cards. Failure to do so may cause you physical injury and damage motherboard components.

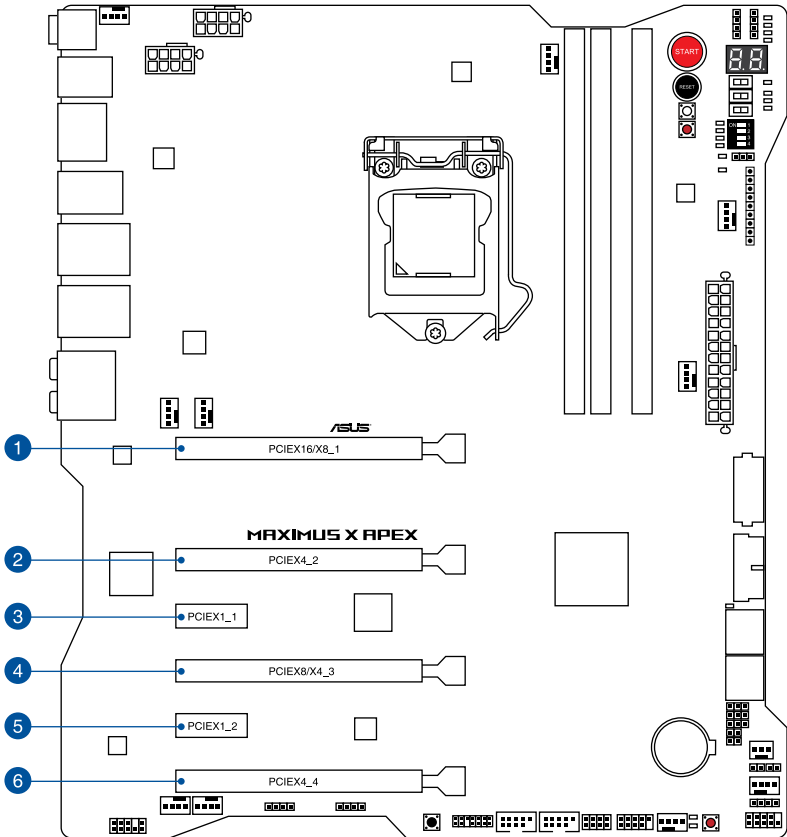

Slot No.	Slot Description
1	PCIe X16/X8_1 slot
2	PCIe X4_2 slot
3	PCIe X1_1 slot
4	PCIe X8/X4_3 slot
5	PCIe X1_2 slot
6	PCIe X4_4 slot

VGA Configuration	PCIe operating mode	
	PCIe_x16/x8_1	PCIe_x8_2
Single VGA/PCIe card	x16 (Recommend for single VGA)	x8
Dual VGA/PCIe card	x8/x8	x4/x4



- We recommend that you provide sufficient power when running CrossFireX™ or SLI™ mode.
- Connect chassis fans to the motherboard chassis fan connectors when using multiple graphics cards for better thermal environment.

### IRQ assignments for this motherboard

	A	B	C	D	E	F	G	H
I.G.F.X	Y	-	-	-	-	-	-	-
High Definition Audio	Y	-	-	-	-	-	-	-
Intel XHCI Controller	Y	-	-	-	-	-	-	-
SATA Controller	Y	-	-	-	-	-	-	-
Intel LAN Controller	Y	-	-	-	-	-	-	-
PCIEX16/X8_1	Y	-	-	-	-	-	-	-
PCIEX4_2	-	-	Y	-	-	-	-	-
PCIEX8/X4_3	-	Y	-	-	-	-	-	-
PCIEX4_4	Y	-	-	-	-	-	-	-
PCIEX1_1	-	-	Y	-	-	-	-	-
PCIEX1_2	-	-	-	Y	-	-	-	-
ASMedia 2142	-	-	Y	-	-	-	-	-
M.2_1	Y	-	-	-	-	-	-	-
M.2_2	Y	-	-	-	-	-	-	-

## 1.1.6 Onboard buttons and switches

Onboard buttons and switches allow you to fine-tune performance when working on a bare or open-case system. This is ideal for overclockers and gamers who continually change settings to enhance system performance.

### 1. Power-on button (START)

The motherboard comes with a power-on button that allows you to power up or wake up the system. The button also lights up when the system is plugged to a power source indicating that you should shut down the system and unplug the power cable before removing or installing any motherboard component.

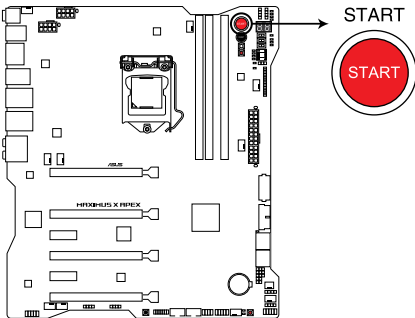

**ROG MAXIMUS X APEX Power on button**

### 2. RESET button (RESET)

Press the reset button to reboot the system.

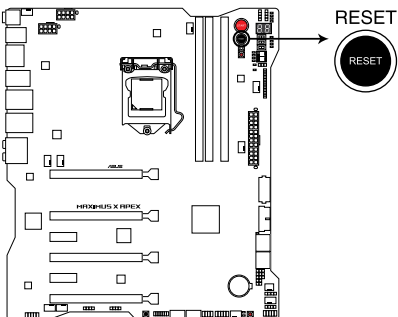

**ROG MAXIMUS X APEX Reset button**

### 3. MemOK! button (MemOK!)

Installing DIMMs that are not compatible with the motherboard may cause system boot failure, and the DRAM LED lights continuously. Press and hold the MemOK! button until the DRAM LED starts blinking to begin automatic memory compatibility tuning for successful boot.

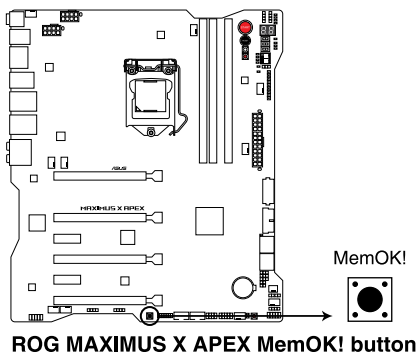

- Refer to section **1.1.8 Onboard LEDs** for the exact location of the Q LEDs (DRAM LED).
- The DRAM LED also lights up when the DIMM is not properly installed. Turn off the system and reinstall the DIMM before using the MemOK! function.
- The MemOK! button does not function under Windows® OS environment.
- During the tuning process, the system loads and tests failsafe memory settings. It takes about 30 seconds for the system to test one set of failsafe settings. If the test fails, the system reboots and test the next set of failsafe settings. The blinking speed of the DRAM LED increases, indicating different test processes.
- Due to memory tuning requirement, the system automatically reboots when each timing set is tested. If the installed DIMMs still fail to boot after the whole tuning process, the DRAM LED lights continuously. Replace the DIMMs with ones recommended in the Memory QVL (Qualified Vendors Lists) at [www.asus.com](http://www.asus.com).
- If you turn off the computer and replace DIMMs during the tuning process, the system continues memory tuning after turning on the computer. To stop memory tuning, turn off the computer and unplug the power cord for about 5–10 seconds.
- If your system fails to boot up due to BIOS overclocking, press the MemOK! button to boot and load the BIOS default settings. A message will appear during POST reminding you that the BIOS has been restored to its default settings.
- We recommend that you download and update to the latest BIOS version from [www.asus.com](http://www.asus.com) after using the MemOK! function.

#### 4. Safe Boot button (SAFE\_BOOT)

The Safe Boot button can be pressed anytime to force the system to reboot into the BIOS safe mode. This button temporarily applies safe settings to the BIOS while retaining any overclocked settings allowing you to modify the settings causing boot failure. Use this button when overclocking or tweaking the settings of your system.

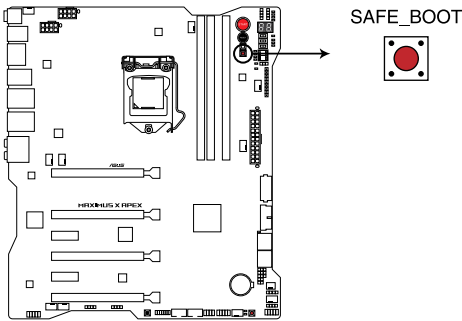

**ROG MAXIMUS X APEX SAFE\_BOOT button**

#### 5. Slow Mode switch (SLOW\_MODE)

Slow Mode Switch is employed during LN2 benching. The system may crash due to the CPU being unstable when using extreme overclocking, enabling slow mode will decrease the processor frequency and stabilize the system, allowing overclockers to keep track of their overclocking data.

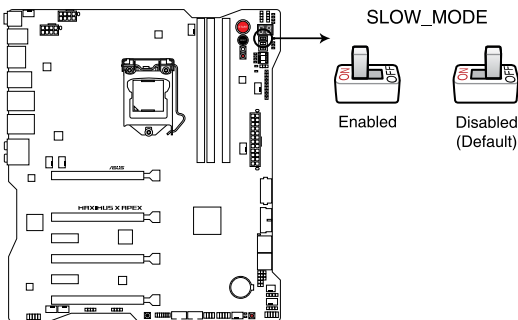

**ROG MAXIMUS X APEX Slow Mode switch**

## 6. ReTry button (RETRY\_BUTTON)

The ReTry button is specially designed for overclockers and is most useful during the booting process where the Reset button is rendered useless. When pressed, it forces the system to reboot while retaining the same settings to be retried in quick succession to achieve a successful POST.

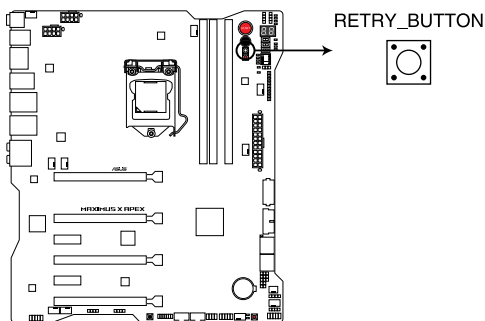

**ROG MAXIMUS X APEX RETRY button**

## 7. BIOS Switch button (BIOS\_SWITCH)

The motherboard comes with two BIOS chips. Press the BIOS button to switch BIOS and load different BIOS settings. The nearby BIOS\_LEDs indicate the currently selected BIOS.

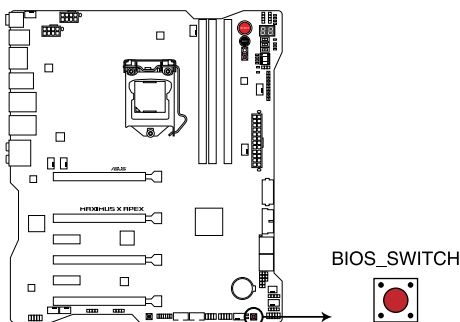

**ROG MAXIMUS X APEX BIOS\_SWITCH button**

## 8. PCIe x16 Lane switch (PCIEX16\_SW1)

These slide switches allows you to enable and disable the corresponding PCIe x16 slots. When one of the installed PCIe x16 cards is out of order, you can use the slide switch to find the faulty one without removing the cards.

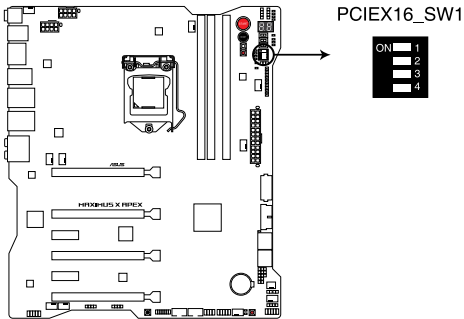

**ROG MAXIMUS X APEX PCIe x16 Lane switch**

## 9. Pause switch (PAUSE)

The pause switch allows you to freeze the cooling system at a hardware level, thus allowing you to adjust your system settings under heavy overclocking.

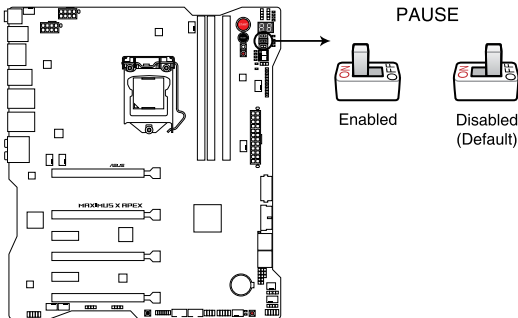

**ROG MAXIMUS X APEX PAUSE switch**

## 10. RSVD switch (RSVD)

This switch is reserved for ASUS-authorized technicians only.

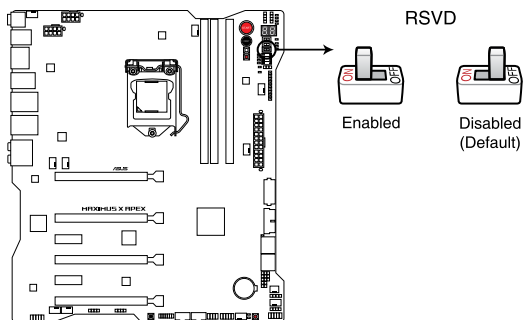

**ROG MAXIMUS X APEX RSVD switch**



---

Ensure to set this switch to disabled, enabling this switch may cause system failure.

---

## 1.1.7 Jumper

### 1. LN2 Mode jumper (3-pin LN2\_MODE)

With LN2 mode activated, the ROG motherboard is optimized to remedy the cold-boot bug during POST and help the system boot successfully.

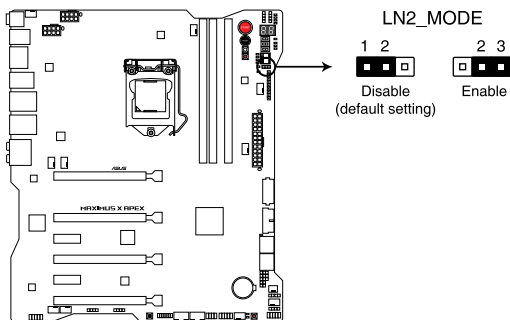

**ROG MAXIMUS X APEX LN2 Mode jumper**

### 2. M.2 light jumper (3-pin M2\_LIGHT)

This jumper allow you to enable and disable the M.2 light.

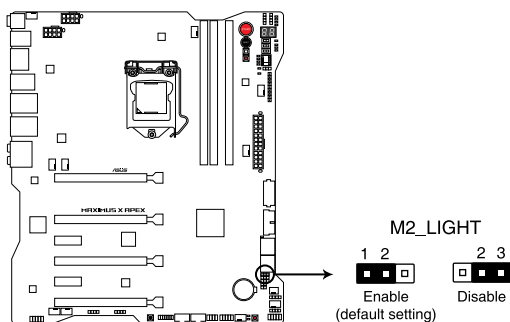

**ROG MAXIMUS X APEX M.2 light jumper**

### 3. Light bar jumpers (3-pin LIGHT\_BAR1-2)

These jumpers allow you to enable or disable the onboard light bar.

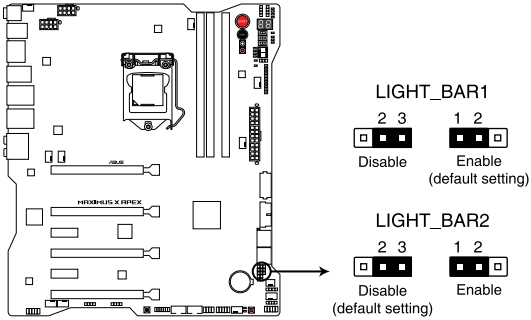

**ROG MAXIMUS X APEX Motherboard light bar jumper**

## 1.1.8 Onboard LEDs

### 1. Q LED (CPU, DRAM, VGA, BOOT)

Q LED checks key components (CPU, DRAM, VGA card, and booting devices) in sequence during motherboard booting process. If an error is found, the corresponding LED remains lit until the problem is solved. This user-friendly design provides an intuitive way to locate the root problem within seconds.

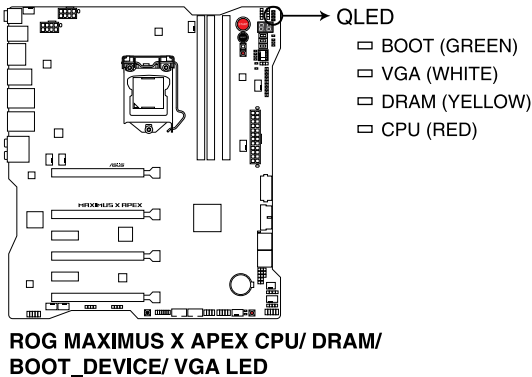

The Q LEDs provide the most probable cause of an error code as a starting point for troubleshooting. The actual cause may vary from case to case.

### 2. Condensation detection LEDs

These LEDs will light up when water condensation is detected on the corresponding critical key components (CPU, DRAM, and PCIE). This user-friendly design helps you quickly identify possible damages caused by condensation.

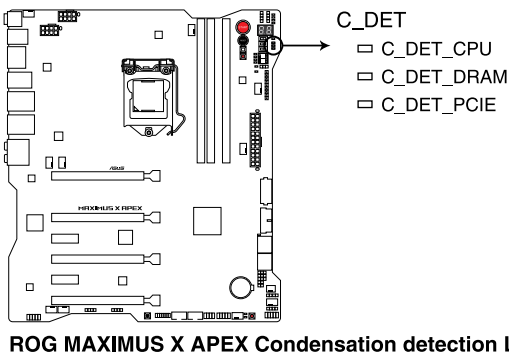

### 3. Q-Code LED

The Q-Code LED design provides you with a 2-digit error code that displays the system status.

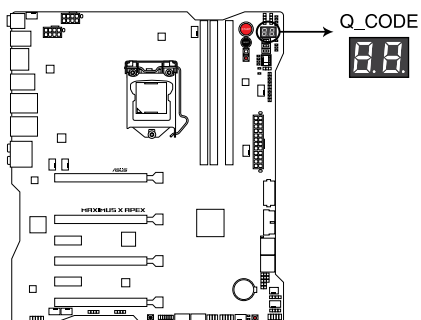

**ROG MAXIMUS X APEX Q-Code LED**



- 
- The Q-Code LED provides the most probable cause of an error code as a starting point for troubleshooting. The actual cause may vary from case to case.
  - Please refer to the Q-Code table in the **Appendix** section for more details.
-

## 1.1.9 Internal connectors

### 1. Intel® Z370 Serial ATA 6 Gb/s connectors (7-pin SATA6G\_12; SATA6G\_34)

These connectors connect to Serial ATA 6 Gb/s hard disk drives via Serial ATA 6 Gb/s signal cables.

If you installed Serial ATA hard disk drives, you can create a RAID 0, 1, 5, and 10 configuration with the Intel® Rapid Storage Technology through the onboard Intel® Z370 chipset.

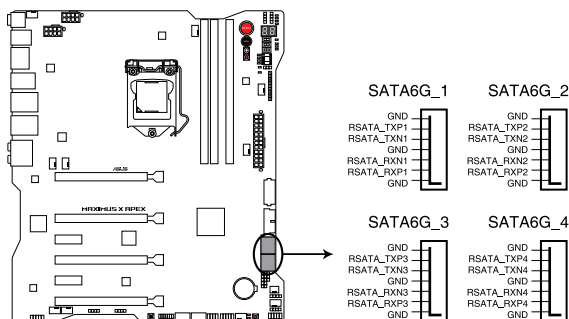

ROG MAXIMUS X APEX Intel® SATA 6 Gb/s connectors

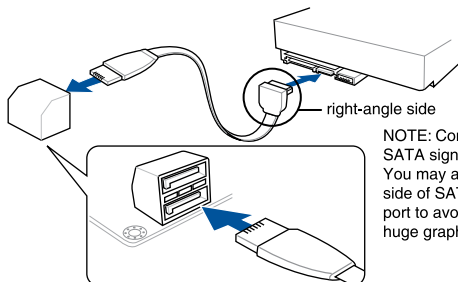

NOTE: Connect the right-angle side of SATA signal cable to SATA device. You may also connect the right-angle side of SATA cable to the onboard SATA port to avoid mechanical conflict with huge graphics cards.



- These connectors are set to **[AHCI]** by default. If you intend to create a Serial ATA RAID set using these connectors, set the SATA Mode Selection item in the BIOS to **[Intel RST Premium With Intel Optane System Acceleration (RAID)]**.
- Before creating a RAID set, refer to section **RAID configurations** or the manual bundled in the motherboard support DVD.
- When using NCQ, set the SATA Mode in the BIOS to **[AHCI]**. Refer to section **SATA Configuration** for details.

## 2. Thermal sensor connectors (2-pin T\_SENSOR1-2)

This connector is for the thermistor cable that allows you to monitor the temperature of your motherboard's critical components and connected devices.

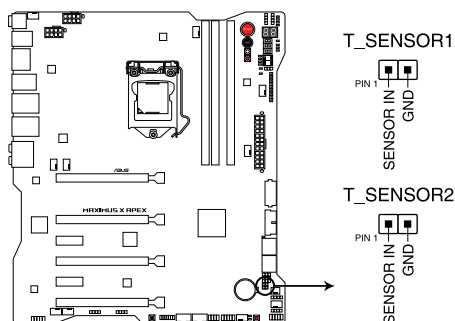

**ROG MAXIMUS X APEX T\_SENSOR connectors**

## 3. USB 3.1 Gen 1 connector (20-1 pin U3G1\_12)

This connector allows you to connect a USB 3.1 Gen 1 module for additional USB 3.1 Gen 1 front or rear panel ports. With an installed USB 3.1 Gen 1 module, you can enjoy all the benefits of USB 3.1 Gen 1 including faster data transfer speeds of up to 5 Gbps, faster charging time for USB-chargeable devices, optimized power efficiency, and backward compatibility with USB 2.0.

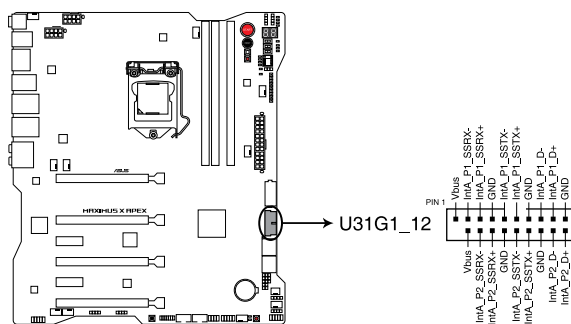

**ROG MAXIMUS X APEX USB 3.1 Gen 1 connector**



The USB 3.1 Gen 1 module is purchased separately.



The plugged USB 3.1 Gen 1 device may run on xHCI or EHCI mode depending on the operating system's setting.

#### 4. USB 2.0 connectors (10-1 pin USB910; USB1112; USB1314)

These connectors are for USB 2.0 ports. Connect the USB module cable to any of these connectors, then install the module to a slot opening at the back of the system chassis. These USB connectors comply with USB 2.0 specification that supports up to 480 MBps connection speed.

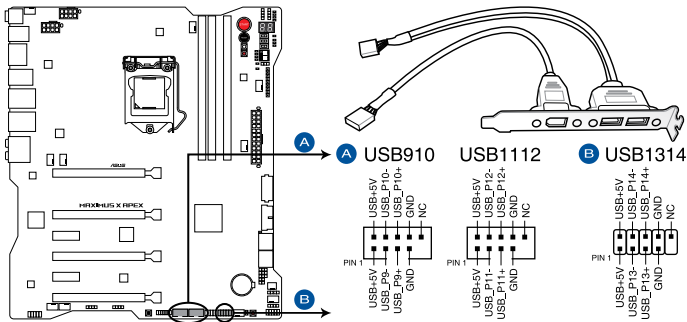

**ROG MAXIMUS X APEX USB 2.0 connectors**



Never connect a 1394 cable to the USB connectors. Doing so will damage the motherboard!



1 x USB 2.0 port (USB1314) at mid-board shares with ROG extension (ROG\_EXT) port.

5. CPU, CPU optional, full speed, and chassis fan connectors; water pump+, and AIO pump connectors (4-pin CPU\_FAN; 4-pin CPU\_OPT; 4-pin FS\_FAN1-3; 4-pin W\_PUMP+; 4-pin AIO\_PUMP; 4-pin CHA\_FAN1-3)

Connect the fan cables to the fan connectors on the motherboard, ensuring that the black wire of each cable matches the ground pin of the connector.

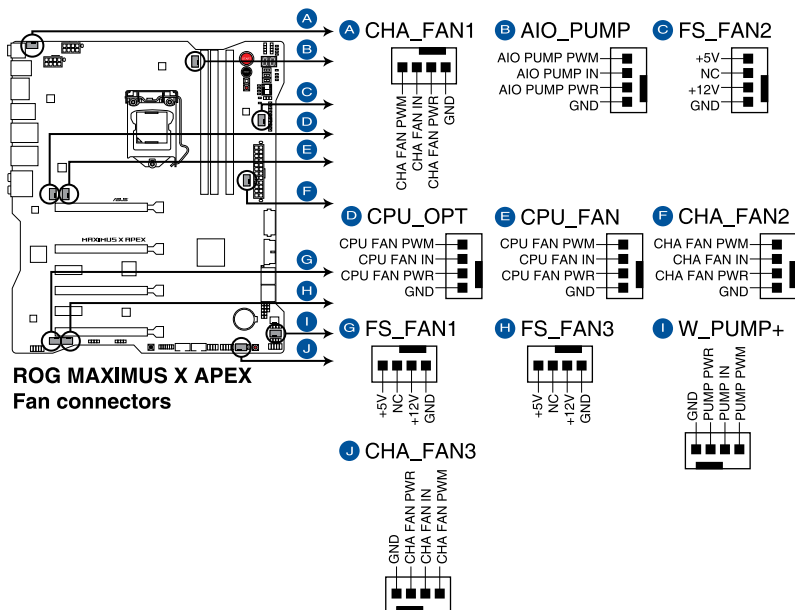

- DO NOT forget to connect the fan cables to the fan connectors. Insufficient air flow inside the system may damage the motherboard components. These are not jumpers! Do not place jumper caps on the fan connectors!
- Ensure to fully insert the 4-pin CPU fan cable to the CPU fan connector.



- Connect the pump cable from the all-in-one cooler (AIO cooler) to the AIO\_PUMP header, and connect the fan cables to the CPU\_FAN and/or CPU\_OPT header(s).
- W\_PUMP+ function support depends on water cooling device.

Header	Max. Current	Max. Power	Default Speed	Shared Control
CPU_FAN	1A	12W	Q-Fan Controlled	A
CPU_OPT	1A	12W	Q-Fan Controlled	A
CHA_FAN1	1A	12W	Q-Fan Controlled	-
CHA_FAN2	1A	12W	Q-Fan Controlled	-
CHA_FAN3	1A	12W	Q-Fan Controlled	-
FS_FAN1	1A	12W	Full Speed	Uncontrollable
FS_FAN2	1A	12W	Full Speed	Uncontrollable
FS_FAN3	1A	12W	Full Speed	Uncontrollable
AIO_PUMP	1A	12W	Full Speed	B
W_PUMP+	3A	36W	Full Speed	B

## 6. Front panel audio connector (10-1 pin AAFP)

This connector is for a chassis-mounted front panel audio I/O module that supports HD Audio standard. Connect one end of the front panel audio I/O module cable to this connector.

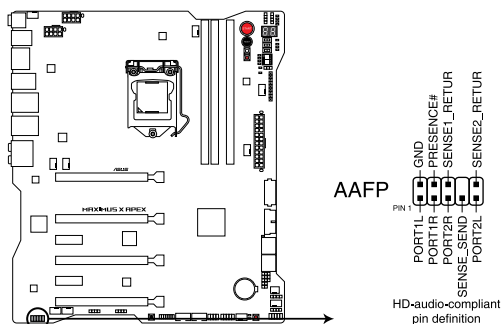

**ROG MAXIMUS X APEX Analog front panel connector**



We recommend that you connect a high-definition front panel audio module to this connector to avail of the motherboard's high-definition audio capability.

## 7. ROG extension connector (18-1 pin ROG\_EXT)

This connector is for the OC Panel I/II and Front Base.

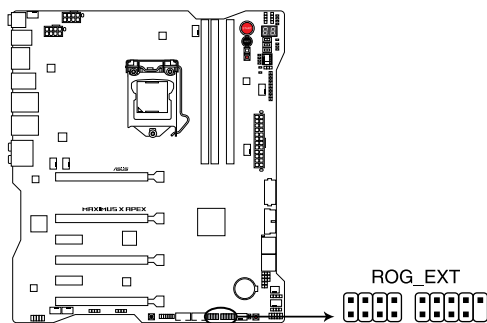

**ROG MAXIMUS X APEX ROG\_EXT connectors**



- The OC Panel I/II and Front Base are purchased separately.
- Support for OC Panel I/II and Front Base varies over different platforms.
- Visit [www.asus.com](http://www.asus.com) for more information about the devices and the latest compatibility list.

## 8. ATX power connectors (24-pin EATXPWR; 8-pin EATX12V\_1; 8-pin EATX12V\_2; 4-pin EZ\_PLUG)

These connectors are for ATX power supply plugs. The power supply plugs are designed to fit these connectors in only one orientation. Find the proper orientation and push down firmly until the connectors completely fit.

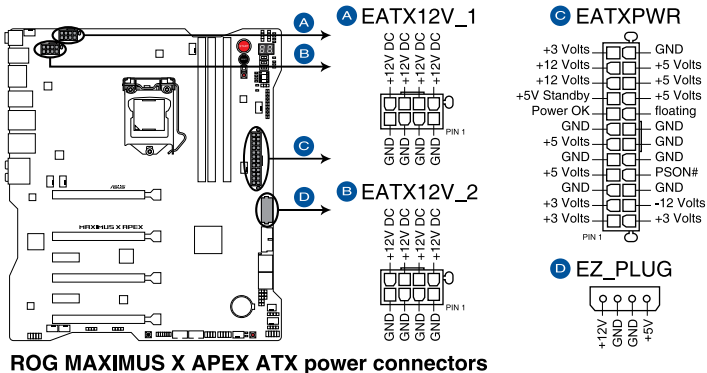

- For a fully configured system, we recommend that you use a power supply unit (PSU) that complies with ATX 12 V Specification 2.0 (or later version) and provides a minimum power of 350 W.
- Do not forget to connect the 8-pin EATX12V power plug. Otherwise, the system will not boot.
- We recommend that you use a PSU with a higher power output when configuring a system with more power-consuming devices. The system may become unstable or may not boot up if the power is inadequate.
- If you want to use two or more high-end PCIe x16 cards, use a PSU with 1000W power or above to ensure the system stability.

## 9. System panel connectors (10-1 pin F\_PANEL; 4-pin SPEAKER)

These connectors supports several chassis-mounted functions.

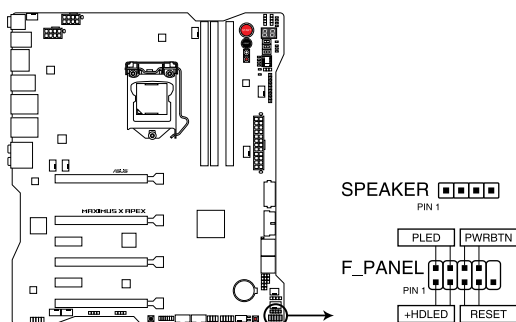

**ROG MAXIMUS X APEX SPEAKER & F\_PANEL connectors**

- **System power LED (2-pin PLED)**

This 2-pin connector is for the system power LED. Connect the chassis power LED cable to this connector. The system power LED lights up when you turn on the system power, and blinks when the system is in sleep mode.

- **Hard disk drive activity LED (2-pin HDLED)**

This 2-pin connector is for the HDD Activity LED. Connect the HDD Activity LED cable to this connector. The HDD LED lights up or flashes when data is read from or written to the HDD.

- **System warning speaker (4-pin SPEAKER)**

This 4-pin connector is for the chassis-mounted system warning speaker. The speaker allows you to hear system beeps and warnings.

- **ATX power button/soft-off button (2-pin PWRBTN)**

This connector is for the system power button. Pressing the power button turns the system on or puts the system in sleep or soft-off mode depending on the BIOS settings. Pressing the power button for more than four seconds while the system is ON turns the system OFF.

- **Reset button (2-pin RESET)**

This 2-pin connector is for the chassis-mounted reset button for system reboot without turning off the system power.

## 10. AURA RGB headers (4-pin RGB\_HEADER1-4)

These connectors are for RGB LED strips.

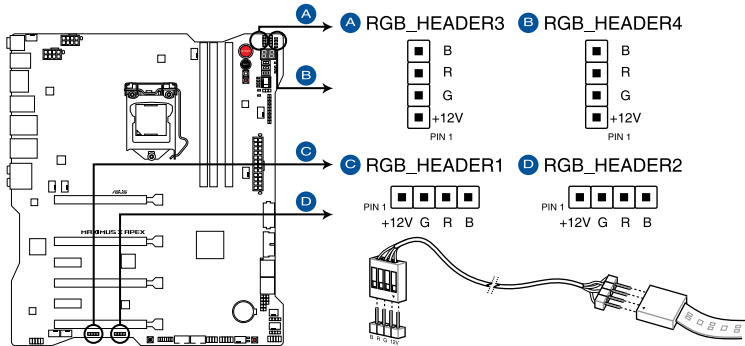

**ROG MAXIMUS X APEX RGB\_HEADER connectors**



The RGB header supports 5050 RGB multi-color LED strips (12V/G/R/B), with a maximum power rating of 3A (12V), and no longer than 3 m.



Before you install or remove any component, ensure that the ATX power supply is switched off or the power cord is detached from the power supply. Failure to do so may cause severe damage to the motherboard, peripherals, or components.



- Actual lighting and color will vary with LED strip.
- If your LED strip does not light up, check if the RGB LED extension cable and the RGB LED strip is connected in the correct orientation, and the 12V connector is aligned with the 12V header on the motherboard.
- The LED strip will only light up when the system is operating.
- The LED strip is purchased separately.

## 11. DIMM.2 slot (DIMM.2\_SLOT)

This socket allows you to install the bundled DIMM.2 card to connect M.2 SSD modules.

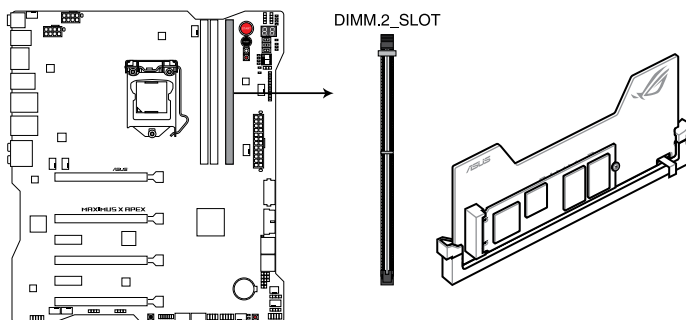

**ROG MAXIMUS X APEX 288-pin DDR4 DIMM.2\_SLOT socket**

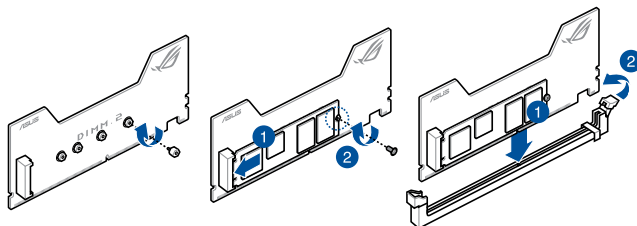

- Before you install or remove the DIMM.2 card, ensure that the ATX power supply is switched off or the power cord is detached from the power supply. Failure to do so may cause severe damage to the motherboard or DIMM.2 card.
- The DIMM.2 card is notched to fit in only one orientation. Ensure that the notch on your card is aligned correctly with the DIMM.2 slot before inserting the card.



- M.2\_1 socket supports PCIe 3.0 x4 M Key design and type 2230 / 2242 / 2260 / 2280 / 22110 PCIe storage devices.
- M.2\_2 socket supports PCIe 3.0 x4 and SATA mode M Key design and type 2230 / 2242 / 2260 / 2280 / 22110 storage devices.
- These sockets support IRST (Intel® Rapid Storage Technology).
- These sockets support Intel® Optane™ Technology. Intel® Optane Technology is only supported when using 8th Generation Intel® Processors. Before using Intel® Optane memory modules, ensure that you have updated your motherboard drivers and BIOS to the latest version from ASUS support website.



The M.2 SSD module is purchased separately.

## 12. TPM connector (14-1 pin TPM)

This connector supports a Trusted Platform Module (TPM) system, which securely stores keys, digital certificates, passwords and data. A TPM system also helps enhance network security, protect digital identities, and ensures platform integrity.

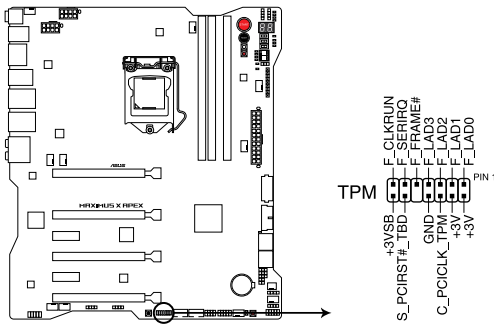

**ROG MAXIMUS X APEX TPM connector**



The TPM module is purchased separately.

## 13. Water in, water out, and water flow connectors (2-pin W\_IN; 2-pin W\_OUT; 3-pin W\_FLOW)

These connectors allow you to connect sensors to monitor the temperature and flow rate of your liquid cooling system. You can manually adjust the fans and water pump to optimize the thermal efficiency of your liquid cooling system.

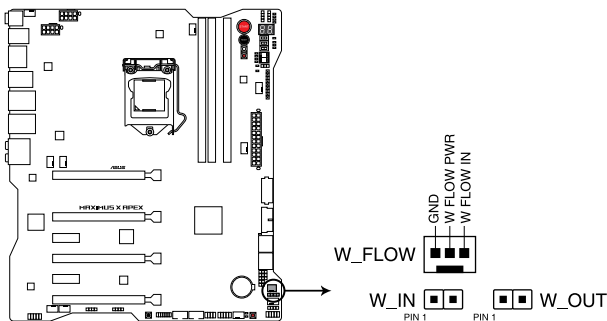

**ROG MAXIMUS X APEX W\_IN, W\_OUT & W\_Flow**

### 1.1.10 Probelt

The ROG Probelt allows you to detect your system's current voltage and OC settings. Use a multimeter to measure the Probelt points even during overclocking.

See the illustration below to locate the respective Probelt points.

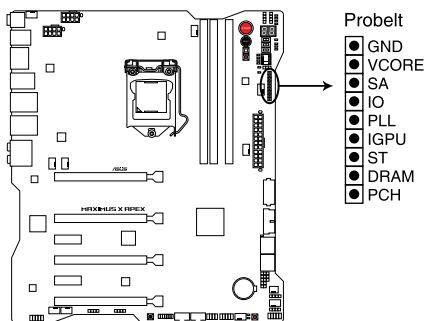

**ROG MAXIMUS X APEX Probelt**

#### Using Probelt

You can connect the multimeter to the motherboard as shown on the following figure.

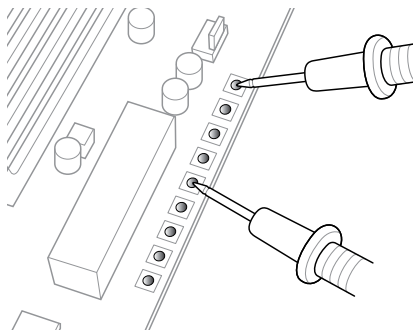

The illustration above is for reference only, the actual motherboard layout and measure points may differ by model.

# Basic Installation

# 2

## 2.1 Building your PC system



The diagrams in this section are for reference only. The motherboard layout may vary with models, but the installation steps are the same for all models.

### 2.1.1 CPU installation



Ensure that you install the correct CPU designed for LGA1151 socket only. **DO NOT** install a CPU designed for LGA1155 and LGA1156 sockets on the LGA1151 socket.

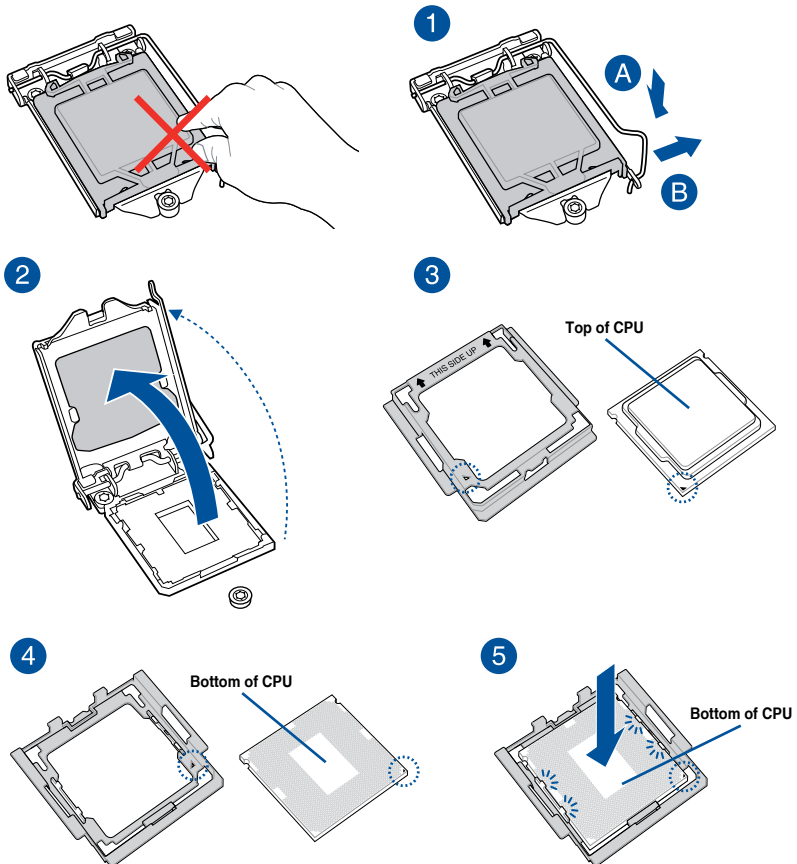

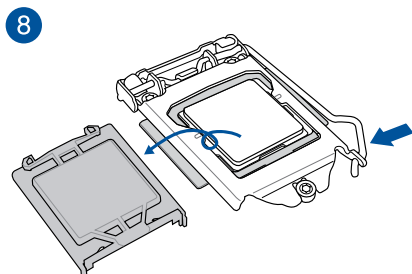
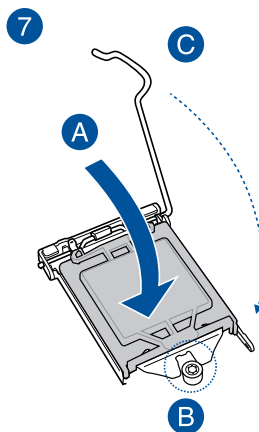
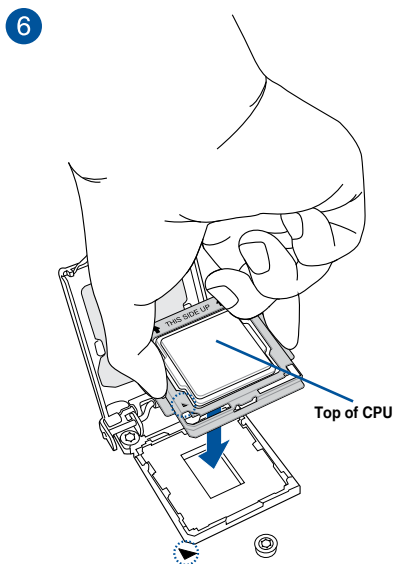

- The CPU Installation Tool is only compatible on ASUS motherboards with a Intel® LGA1151 socket.
- Ensure that the CPU is firmly clicked into place before installing it onto the CPU socket on the motherboard.
- Use the CPU Installation Tool for installing the CPU only. DO NOT damage or bend the CPU Installation Tool.
- Always firmly hold both sides of the CPU Installation Tool when installing, removing, or picking up the CPU Installation Tool.
- Ensure to use a soft stable surface when installing the CPU to the CPU Installation Tool to prevent CPU damage.
- ASUS will not cover damages resulting from incorrect CPU installation/removal, incorrect CPU orientation/placement, or other damages resulting from negligence by the user.

## 2.1.2 Cooling system installation

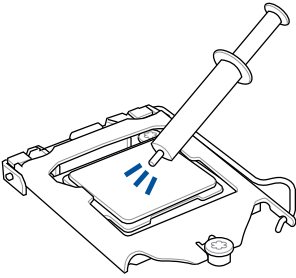

Apply the Thermal Interface Material to the CPU cooling system and CPU before you install the cooling system, if necessary.

### To install a CPU heatsink and fan assembly

1

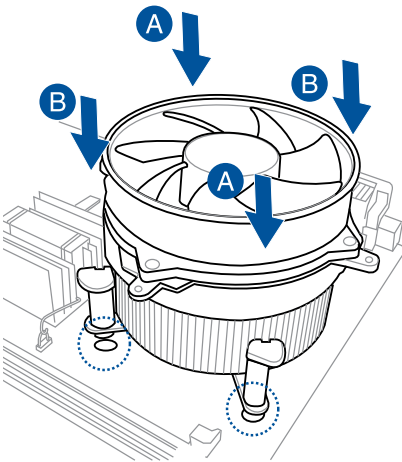

2

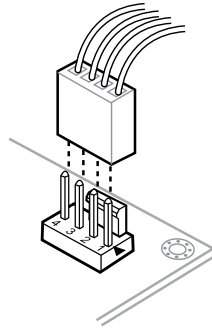

3

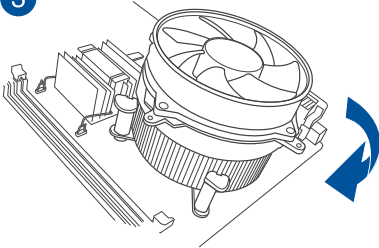

4

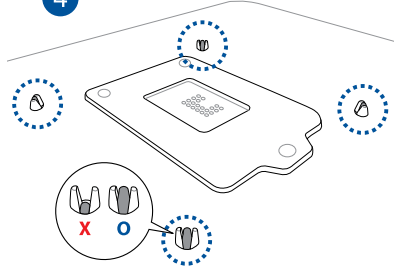

## To install an AIO cooler

1

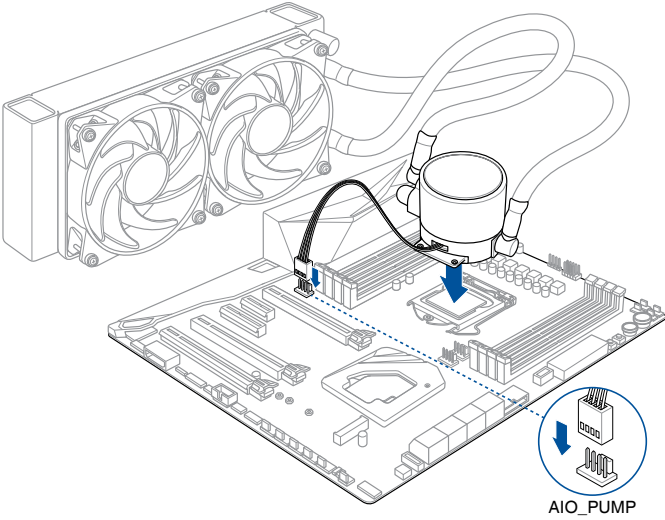

2

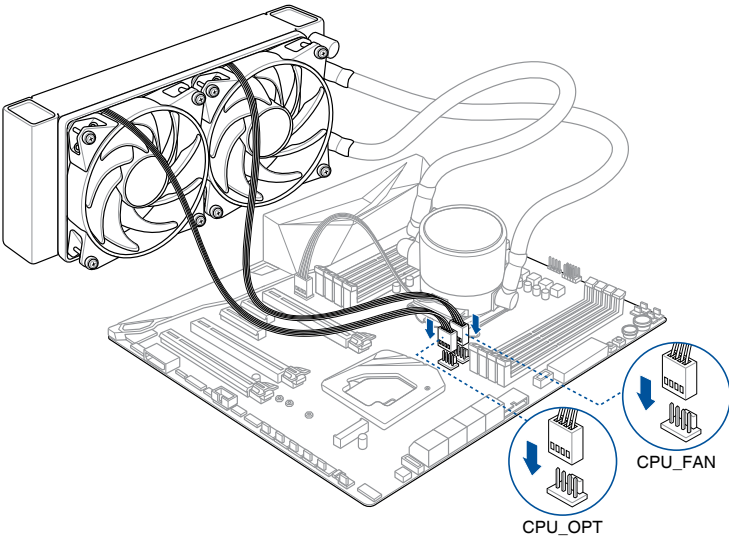

- Place nine (9) screws into the holes indicated by circles to secure the motherboard to the chassis.

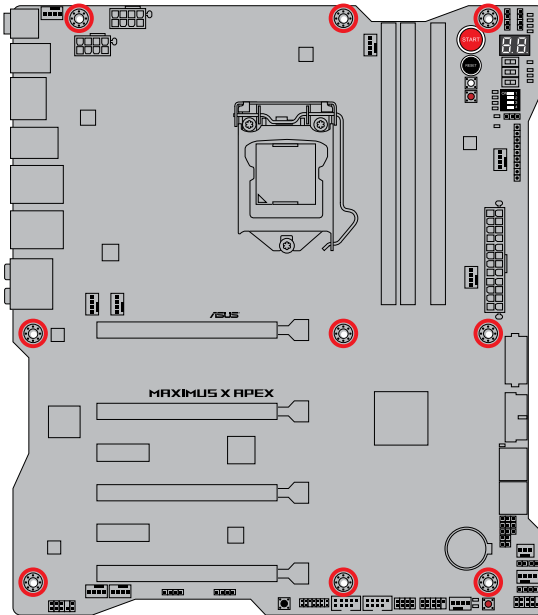
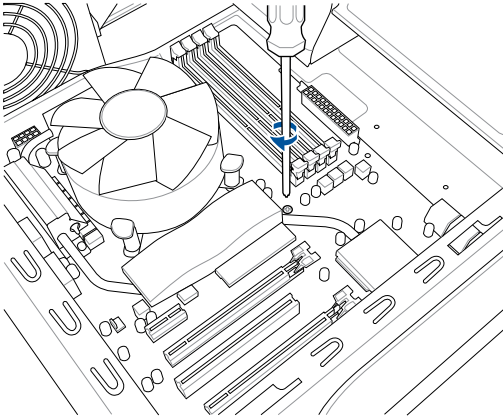

**DO NOT** over tighten the screws! Doing so can damage the motherboard.

## 2.1.3 Motherboard installation

1. Install the ASUS Q-Shield to the chassis rear I/O panel.

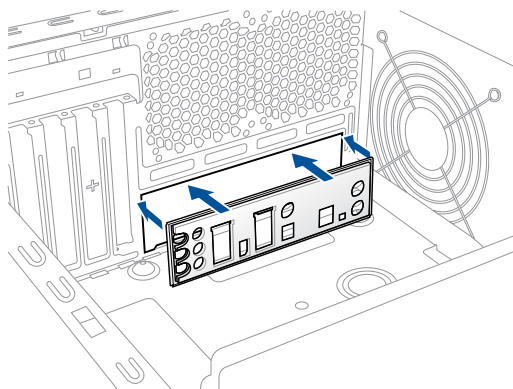

2. Place the motherboard into the chassis, ensuring that its rear I/O ports are aligned to the chassis' rear I/O panel.

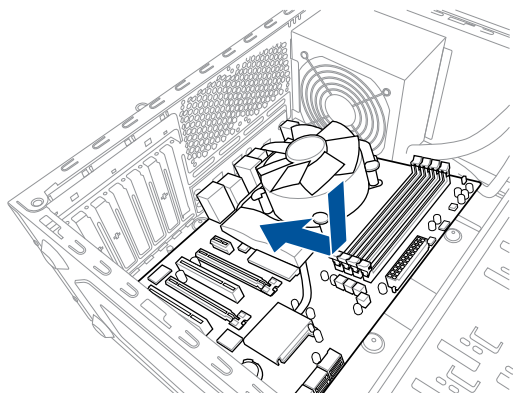

## 2.1.4 DIMM installation

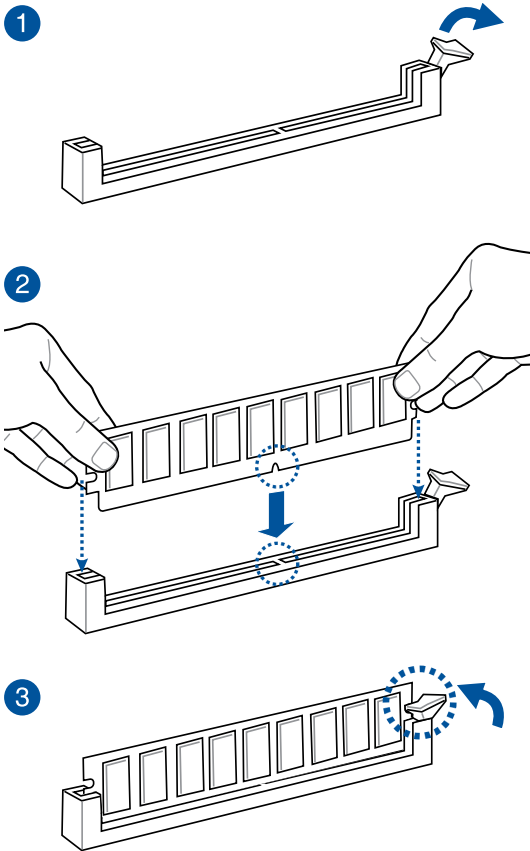

To remove a DIMM

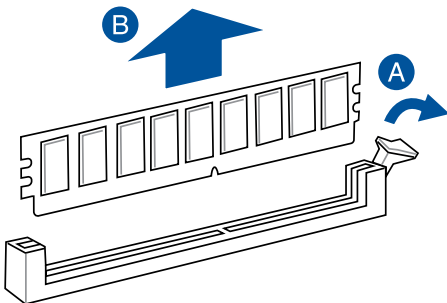

## 2.1.5 ATX power connection

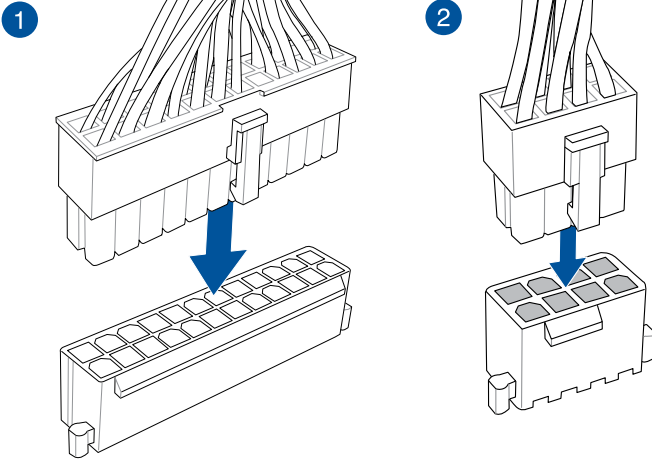

Ensure to connect the 8-pin power plug.

## 2.1.6 SATA device connection

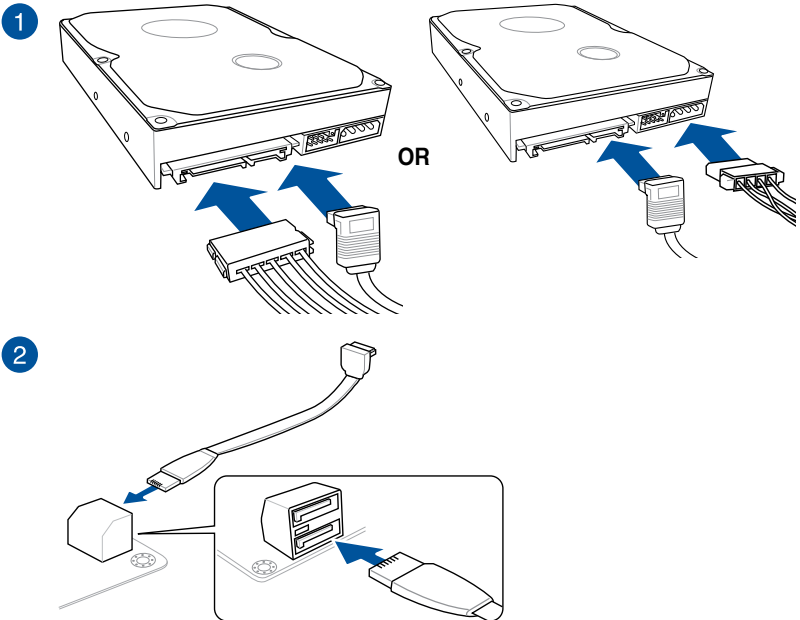

## 2.1.7 Front I/O connector

### To install ASUS Q-Connector

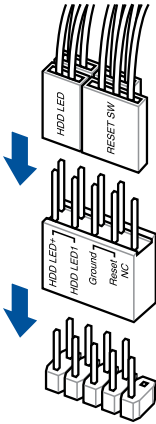

### To install USB 3.1 Gen 1 connector

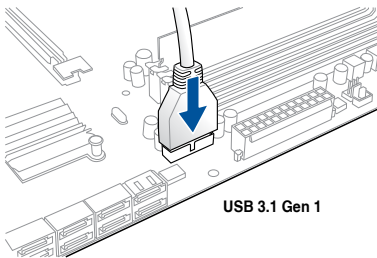

### To install USB 2.0 connector

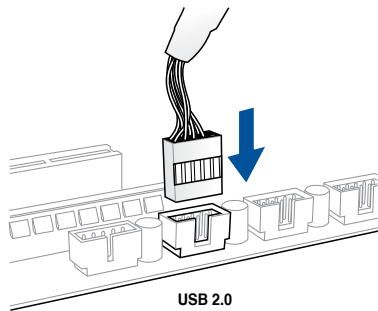

### To install front panel audio connector

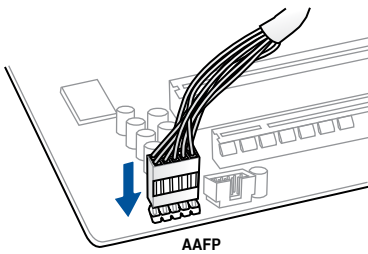

### To install system speaker connector

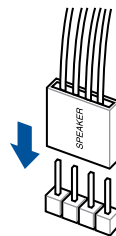

## 2.1.8 Expansion card installation

To install PCIe x16 cards

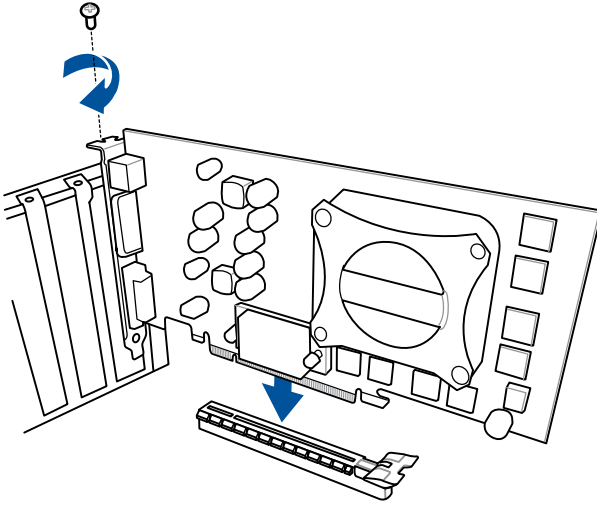

To install PCIe x1 cards

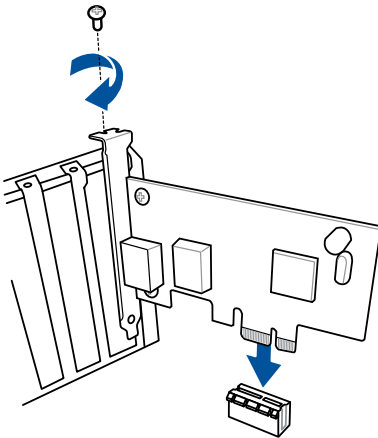

## 2.1.9 Fan bracket installation

To install the DIMM.2 FAN mount

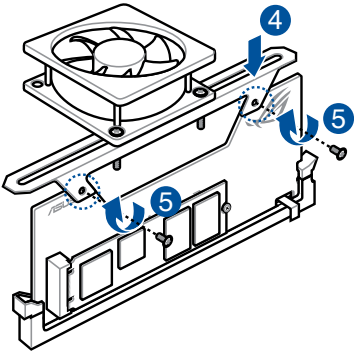
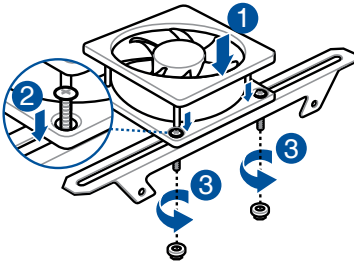

- You may install up to two 50mm x 50mm fans or a single 100mm x 100 mm fan.
- Fans are purchased separately.

## 2.2 BIOS update utility

### USB BIOS Flashback

USB BIOS Flashback allows you to easily update the BIOS without entering the existing BIOS or operating system. Simply insert a USB storage device to the USB port, press the USB BIOS Flashback button for three seconds, and the BIOS is updated automatically.

#### To use USB BIOS Flashback:

1. Insert a USB storage device to the USB Flashback port.



We recommend you to use a USB 2.0 storage device to save the latest BIOS version for better compatibility and stability.

2. Visit <https://www.asus.com/support/> and download the latest BIOS version for this motherboard.
3. Rename the file as **M10A.CAP**, then copy it to your USB storage device.
4. Shut down your computer.
5. Press the BIOS Flashback button for three seconds until the Flashback LED blinks three times, indicating that the BIOS Flashback function is enabled.

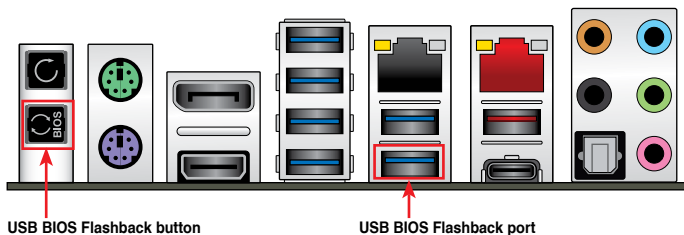

For more BIOS update utilities in BIOS setup, refer to the section **Updating BIOS** in Chapter 3.



Updating BIOS may have risks. If the BIOS program is damaged during the process and results to the system's failure to boot up, please contact your local ASUS Service Center.

## 2.3 Motherboard rear and audio connections

### 2.3.1 Rear I/O connection

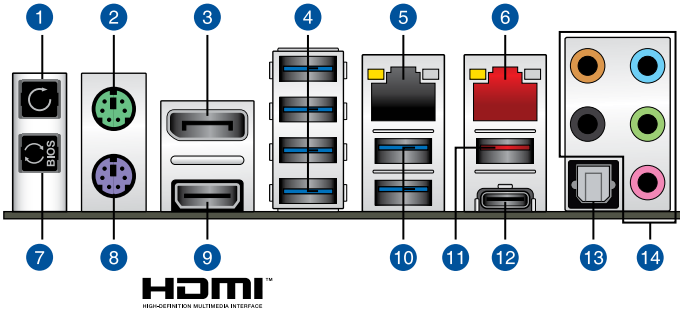

#### Rear panel connectors

- |     |  |
|-----|--|
| 1.  | Clear CMOS button (CLR_CMOS). Press this button to clear the BIOS setup information only when the systems hangs due to overclocking. |
| 2.  | PS/2 mouse port  |
| 3.  | DisplayPort  |
| 4.  | Intel® USB 3.1 Gen 1 ports 5, 6, 7, and 8  |
| 5.  | Aquantia AQC-107 10G LAN port*   |
| 6.  | LAN (RJ-45) port*  |
| 7.  | USB BIOS Flashback button  |
| 8.  | PS/2 keyboard port   |
| 9.  | HDMI port  |
| 10. | Intel® USB 3.1 Gen 1 ports 3 and 4   |
| 11. | USB 3.1 Gen 2 Type-A port E2   |
| 12. | USB 3.1 Gen 2 Type-C™ port EC1   |
| 13. | Optical S/PDIF OUT port  |
| 14. | Audio I/O ports**  |

\* and \*\*: Refer to the tables on the next page for LAN port LEDs, and audio port definitions.



- USB 3.1 Gen 1 devices can only be used as data storage only.
- We strongly recommend that you connect USB 3.1 Gen 1 devices to USB 3.1 Gen 1 ports for faster and better performance for your USB 3.1 Gen 1 devices.
- Due to the design of the Intel chipset, all USB devices connected to the USB 2.0 and USB 3.1 Gen 1 ports are controlled by the xHCI controller. Some legacy USB devices must update their firmware for better compatibility.

### \* LAN port LED indications

Activity Link LED		Speed LED	
Status	Description	Status	Description
Off	No link	Off	10 Mbps connection
Orange	Linked	Orange	100 Mbps connection
Orange (Blinking)	Data activity	Green	1 Gbps connection
Orange (Blinking then steady)	Ready to wake up from S5 mode		

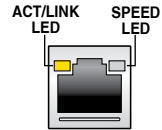

You can disable the LAN controllers in BIOS. Due to hardware design, the LAN1 port's LEDs may continue to blink even when disabled.

### \* Aquantia AQC-108 5G LAN port LED indications

Activity Link LED		Speed LED	
Status	Description	Status	Description
OFF	No Link	OFF	10 Mbps connection
Blinking	Link	GREEN	5 Gbps connection
		ORANGE	2.5 Gbps / 1 Gbps / 100Mbps connection

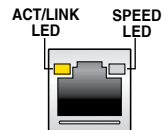

### \*\* Audio 2, 4, 6 or 8-channel configuration

Port	Headset 2-channel	4-channel	6-channel	8-channel
Light Blue	Line In	Line In	Line In	Side Speaker Out
Lime	Line Out	Front Speaker Out	Front Speaker Out	Front Speaker Out
Pink	Mic In	Mic In	Mic In	Mic In
Orange	–	–	Center/Sub woofer	Center/Sub woofer
Black	–	Rear Speaker Out	Rear Speaker Out	Rear Speaker Out

## 2.3.2 Audio I/O connections

### Audio I/O ports

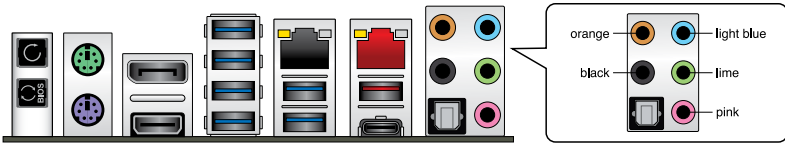

### Connect to Headphone and Mic



### Connect to Stereo Speakers

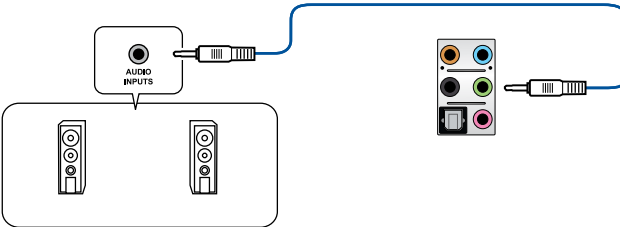

### Connect to 2 Speakers

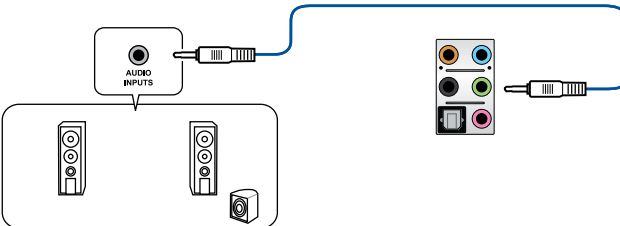

## Connect to 4 Speakers

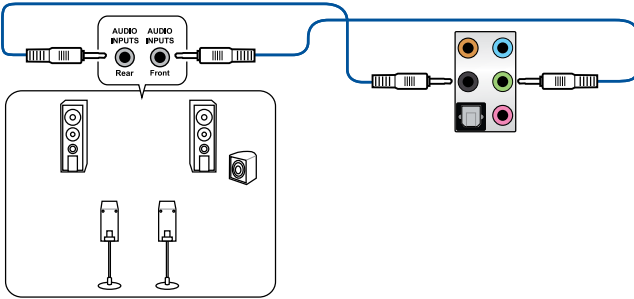

## Connect to 6 Speakers

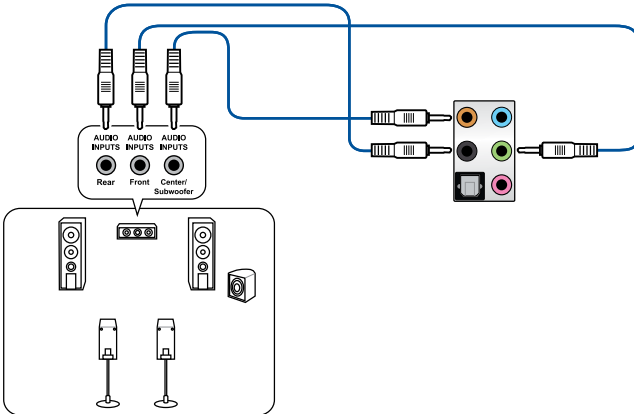

## Connect to 8 Speakers

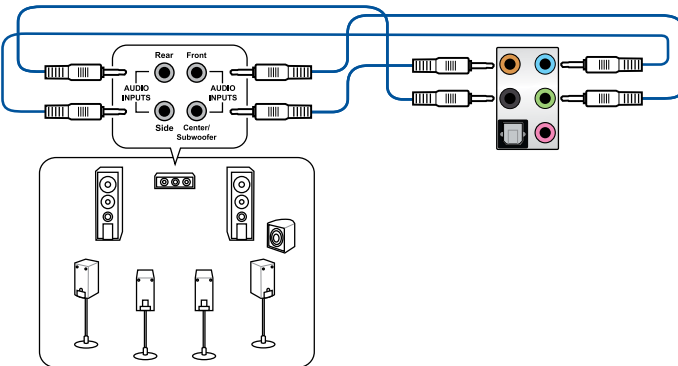

## 2.4 Starting up for the first time

1. After making all the connections, replace the system case cover.
2. Ensure that all switches are off.
3. Connect the power cord to the power connector at the back of the system chassis.
4. Connect the power cord to a power outlet that is equipped with a surge protector.
5. Turn on the devices in the following order:
  - a. Monitor
  - b. External SCSI devices (starting with the last device on the chain)
  - c. System power
6. After applying power, the system power LED on the system front panel case lights up. For systems with ATX power supplies, the system LED lights up when you press the ATX power button. If your monitor complies with the “green” standards or if it has a “power standby” feature, the monitor LED may light up or change from orange to green after the system LED turns on.

The system then runs the power-on self tests (POST). While the tests are running, the BIOS beeps (refer to the BIOS beep codes table) or additional messages appear on the screen. If you do not see anything within 30 seconds from the time you turned on the power, the system may have failed a power-on test. Check the jumper settings and connections or call your retailer for assistance.

BIOS Beep	Description
One short beep	VGA detected Quick boot set to disabled No keyboard detected
One continuous beep followed by two short beeps then a pause (repeated)	No memory detected
One continuous beep followed by three short beeps	No VGA detected
One continuous beep followed by four short beeps	Hardware component failure

7. At power on, hold down the <Delete> key to enter the BIOS Setup. Follow the instructions in Chapter 3.

## 2.5 Turning off the computer

While the system is ON, press the power button for less than four seconds to put the system on sleep mode or soft-off mode, depending on the BIOS setting. Press the power button for more than four seconds to let the system enter the soft-off mode regardless of the BIOS setting.



# BIOS Setup

# 3

## 3.1 Knowing BIOS

---



The new ASUS UEFI BIOS is a Unified Extensible Interface that complies with UEFI architecture, offering a user-friendly interface that goes beyond the traditional keyboard-only BIOS controls to enable a more flexible and convenient mouse input. You can easily navigate the new UEFI BIOS with the same smoothness as your operating system. The term “BIOS” in this user manual refers to “UEFI BIOS” unless otherwise specified.

---

BIOS (Basic Input and Output System) stores system hardware settings such as storage device configuration, overclocking settings, advanced power management, and boot device configuration that are needed for system startup in the motherboard CMOS. In normal circumstances, the default BIOS settings apply to most conditions to ensure optimal performance. **DO NOT change the default BIOS settings** except in the following circumstances:

- An error message appears on the screen during the system bootup and requests you to run the BIOS Setup.
- You have installed a new system component that requires further BIOS settings or update.



Inappropriate BIOS settings may result to instability or boot failure. **We strongly recommend that you change the BIOS settings only with the help of a trained service personnel.**

---



- When downloading or updating the BIOS file, rename it as **M10A.CAP** for this motherboard.
  - BIOS settings and options may vary due to different BIOS release versions. Please refer to the latest BIOS version for settings and options.
-

## 3.2 BIOS setup program

Use the BIOS Setup to update the BIOS or configure its parameters. The BIOS screen include navigation keys and brief onscreen help to guide you in using the BIOS Setup program.

### Entering BIOS at startup

To enter BIOS Setup at startup, press <Delete> or <F2> during the Power-On Self Test (POST). If you do not press <Delete> or <F2>, POST continues with its routines.

### Entering BIOS Setup after POST

To enter BIOS Setup after POST:

- Press <Ctrl>+<Alt>+<Delete> simultaneously.
- Press the reset button on the system chassis.
- Press the power button to turn the system off then back on. Do this option only if you failed to enter BIOS Setup using the first two options.

After doing either of the three options, press <Delete> key to enter BIOS.



- 
- The BIOS setup screens shown in this section are for reference purposes only, and may not exactly match what you see on your screen.
  - Ensure that a USB mouse is connected to your motherboard if you want to use the mouse to control the BIOS setup program.
  - If the system becomes unstable after changing any BIOS setting, load the default settings to ensure system compatibility and stability. Select the **Load Optimized Defaults** item under the **Exit** menu or press hotkey <F5>. See section 3.10 **Exit Menu** for details.
  - If the system fails to boot after changing any BIOS setting, try to clear the CMOS and reset the motherboard to the default value. See section 2.3.1 **Rear I/O connection** for information on how to erase the RTC RAM via the Clear CMOS button.
  - The BIOS setup program does not support the Bluetooth devices.
- 



---

Please visit ASUS website for the detailed BIOS content manual.

---

### BIOS menu screen

The BIOS Setup program can be used under two modes: **EZ Mode** and **Advanced Mode**. You can change modes from **Setup Mode** in **Boot menu** or by pressing the <F7> hotkey.

### 3.2.1 Advanced Mode

The Advanced Mode provides advanced options for experienced end-users to configure the BIOS settings. The figure below shows an example of the Advanced Mode. Refer to the following sections for the detailed configurations.



The default screen for entering the BIOS setup program can be changed. Refer to the **Setup Mode** item in section **Boot menu** for details.

The screenshot shows the BIOS Advanced Mode interface. The top bar includes 'UEFI BIOS Utility - Advanced Mode', the date '08/15/2017 Thursday', the time '10:15', and language 'English'. Navigation options include 'MyFavorite(F3)', 'Qfan Control(F6)', 'EZ Tuning Wizard(F11)', and 'Hot Keys'. A 'Scroll bar' is visible on the right side of the top bar.

The main menu includes 'My Favorites', 'Main', 'Extreme Tweaker', 'Advanced', 'Monitor', 'Boot', 'Tool', and 'Exit'. The 'Advanced' section is currently selected, showing settings for 'LN2 Mode' (Disabled), 'Target CPU Turbo-Mode Frequency: 4000MHz', 'Target CPU @ AVX Frequency: 4000MHz', 'Target DRAM Frequency: 2133MHz', and 'Target Cache Frequency: 3700MHz'. The 'AI Overclock Tuner' is set to 'Auto', and 'ASUS MultiCore Enhancement' is set to 'Manual'. The 'AVX Instruction Core Ratio Negative Offset' is set to '0'. The 'CPU Core Ratio' section shows '1-Core Ratio Limit', '2-Core Ratio Limit', '3-Core Ratio Limit', and '4-Core Ratio Limit', all set to 'Auto'. A 'Sync All Cores' button is also present.

The 'Hardware Monitor' panel on the right provides a quick overview of system status, including CPU (Frequency: 2800 MHz, Temperature: 51°C, BCLK: 100.0 MHz, Core Voltage: 0.960 V, Ratio: 28x) and Memory (Frequency: 2133 MHz, Voltage: 1.200 V, Capacity: 4096 MB). The 'Voltage' section shows +12V (+5V), +3.3V (3.376 V), and +5V (5.040 V).

At the bottom, there is a footer with 'Version 2.17.1246. Copyright (C) 2017 American Megatrends, Inc.', 'Last Modified', 'EZMode(F7) [F7]', and 'Search on FAQ'. A 'General help' icon is also visible.

Labels in the image point to various features: 'Configuration fields' (top bar), 'Pop-up Menu' (dropdowns), 'Menu bar' (main navigation), 'Language' (English), 'MyFavorite(F3)', 'Qfan Control(F6)', 'EZ Tuning Wizard(F11)', 'Hot Keys', 'Scroll bar', 'Menu items' (main menu), 'General help' (info icon), 'Last modified settings' (Last Modified), 'Go back to EZ Mode' (EZMode(F7) [F7]), and 'Search on the FAQ' (Search on FAQ).

Additional text labels include: 'Displays a quick overview of the system status' (pointing to the Hardware Monitor panel) and 'Chapter 3' (on the right side of the page).

## Menu bar

The menu bar on top of the screen has the following main items:

<b>My Favorites</b>	For saving the frequently-used system settings and configuration.
<b>Main</b>	For changing the basic system configuration
<b>Extreme Tweaker</b>	For changing the overclocking settings
<b>Advanced</b>	For changing the advanced system settings
<b>Monitor</b>	For displaying the system temperature, power status, and changing the fan settings.
<b>Boot</b>	For changing the system boot configuration
<b>Tool</b>	For configuring options for special functions
<b>Exit</b>	For selecting the exit options and loading default settings

## Menu items

The highlighted item on the menu bar displays the specific items for that menu. For example, selecting **Main** shows the Main menu items.

The other items (My Favorites, Ai Tweaker, Advanced, Monitor, Boot, Tool, and Exit) on the menu bar have their respective menu items.

## Submenu items

A greater than sign (>) before each item on any menu screen means that the item has a submenu. To display the submenu, select the item and press <Enter>.

## Language

This button above the menu bar contains the languages that you can select for your BIOS. Click this button to select the language that you want to display in your BIOS screen.

## My Favorites(F3)

This button above the menu bar shows all BIOS items in a Tree Map setup. Select frequently-used BIOS settings and save it to MyFavorites menu.



---

Refer to section **3.3 My Favorites** for more information.

---

## Q-Fan Control(F6)

This button above the menu bar displays the current settings of your fans. Use this button to manually tweak the fans to your desired settings.



---

Refer to section **3.2.3 Q-Fan Control** for more information.

---

## EZ Tuning Wizard(F11)

This button above the menu bar allows you to view and tweak the overclocking settings of your system. It also allows you to change the motherboard's SATA mode from AHCI to RAID mode.



---

Refer to section **3.2.4 EZ Tuning Wizard** for more information.

---

## Search on FAQ

Move your mouse over this button to show a QR code, scan this QR code on your mobile device to connect to the BIOS FAQ web page of the ASUS support website. You can also scan the following QR code:



## Hot keys

This button above the menu bar contains the navigation keys for the BIOS setup program. Use the navigation keys to select items in the menu and change the settings.

## Scroll bar

A scroll bar appears on the right side of a menu screen when there are items that do not fit on the screen. Press the Up/Down arrow keys or <Page Up> / <Page Down> keys to display the other items on the screen.

## General help

At the bottom of the menu screen is a brief description of the selected item. Use <F12> key to capture the BIOS screen and save it to the removable storage device.

## Configuration fields

These fields show the values for the menu items. If an item is user-configurable, you can change the value of the field opposite the item. You cannot select an item that is not user-configurable.

A configurable field is highlighted when selected. To change the value of a field, select it and press <Enter> to display a list of options.

## Last Modified button

This button shows the items that you last modified and saved in BIOS Setup.

### 3.2.2 EZ Mode

By default, the EZ Mode screen appears when you enter the BIOS setup program. The EZ Mode provides you an overview of the basic system information, and allows you to select the display language, system performance, mode and boot device priority. To access the Advanced Mode, select **Advanced Mode** or press the <F7> hotkey for the advanced BIOS settings.



To switch from Advanced Mode to EZ Mode, click **EZ Mode(F7)** or press the <F7> hotkey.

**Displays the system properties of the selected mode. Click < or > to switch EZ System Tuning modes**

**Displays the CPU/motherboard temperature, CPU voltage output, CPU/chassis/power fan speed, and SATA information**

**Selects the display language of the BIOS setup program**

**Creates storage RAID and configures system overlocking**

**Displays the CPU Fan's speed. Click the button to manually tune the fans**

**Enables or disables the SATA RAID mode for Intel Rapid Storage Technology**

**Saves the changes and resets the system**

**Click to go to Advanced mode**

**Search on the FAQ**

**Click to display boot devices**

**Selects the boot device priority**

**Loads optimized default settings**

**Search on the FAQ**

**Displays the CPU/motherboard temperature, CPU voltage output, CPU/chassis/power fan speed, and SATA information**

**Displays the system properties of the selected mode. Click < or > to switch EZ System Tuning modes**

**Creates storage RAID and configures system overlocking**

**Selects the display language of the BIOS setup program**

**Loads optimized default settings**

**Click to go to Advanced mode**

**Search on the FAQ**

**Click to display boot devices**

**Selects the boot device priority**



The boot device options vary depending on the devices you installed to the system.

### 3.2.3 Q-Fan Control

The QFan Control allows you to set a fan profile or manually configure the operating speed of your CPU and chassis fans.

The screenshot shows the Q-Fan Control utility interface. At the top, it says "Q-Fan Control" and provides instructions: "Select your target fan and then move the slider to select any of these profiles: Standard, Silent, Turbo and Full Speed. You can also move the slider to Manual and manually configure the fan's operating speed." Below this is a list of fan types: CPU FAN, CHA1 FAN, CHA2 FAN, CHA3 FAN, AIO PUMP, and W\_PUMP+. A graph shows fan speed (%) on the y-axis (0 to 100) and temperature (°C) on the x-axis (0 to 100). The graph displays a profile that starts at 50% speed at 0°C, remains constant until 30°C, then rises to 100% speed at 70°C and stays there. Above the graph are "PWM" and "DC" mode buttons. Below the graph are radio buttons for "Standard", "Silent", "Turbo", "Full Speed", and "Manual". At the bottom are "Undo", "Apply", and "Exit (ESC)" buttons. Red lines with text boxes point to various elements: "Click to select a fan to be configured" points to the fan list; "Click to activate PWM Mode" points to the PWM button; "Click to activate DC Mode" points to the DC button; "Select a profile to apply to your fans" points to the radio buttons; "Click to apply the fan setting" points to the Apply button; "Click to go back to main menu" points to the Exit (ESC) button; "Click to undo the changes" points to the Undo button; and "Select to manually configure your fans" points to the Manual radio button.

Click to select a fan to be configured

Click to activate PWM Mode

Click to activate DC Mode

Q-Fan Control  
Select your target fan and then move the slider to select any of these profiles: Standard, Silent, Turbo and Full Speed. You can also move the slider to Manual and manually configure the fan's operating speed.

Optimize All

CPU FAN  
CHA1 FAN  
CHA2 FAN  
CHA3 FAN  
AIO PUMP  
W\_PUMP+

100%  
50%  
0%  
0 30 70 100 °C

PWM DC

Standard Silent Turbo Full Speed Manual

Undo Apply Exit (ESC)

Select a profile to apply to your fans

Click to apply the fan setting

Click to go back to main menu

Click to undo the changes

Select to manually configure your fans

## Configuring fans manually

Select **Manual** from the list of profiles to manually configure your fans' operating speed.



Speed points

Select to manually  
configure your fans

To configure your fans:

1. Select the fan that you want to configure and to view its current status.
2. Click and drag the speed points to adjust the fans' operating speed.
3. Click **Apply** to save the changes then click **Exit (ESC)**.

### 3.2.4 EZ Tuning Wizard

EZ Tuning Wizard allows you to easily overclock your CPU and DRAM, computer usage, and CPU fan to their best settings. You can also set RAID in your system using this feature.



#### OC Tuning

To start OC Tuning:

1. Press <F11> on your keyboard or click  from the BIOS screen to open EZ Tuning Wizard screen.
2. Click **OC** then click **Next**.
3. Select a PC scenario **Daily Computing** or **Gaming/Media Editing**, then click **Next**.

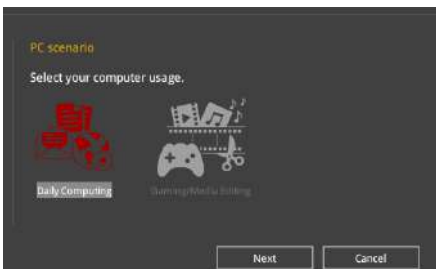

4. Select a Main Cooling System **BOX cooler**, **Tower cooler**, **Water cooler**, or **I'm not sure**, then click **Next**.



5. After selecting the Main Cooling System, click **Next** then click **Yes** to start the OC Tuning.

## Creating RAID

To create RAID:

1. Press <F11> on your keyboard or click **EZ Tuning Wizard(F11)** from the BIOS screen to open EZ Tuning Wizard screen.
2. Click **RAID** then click **Next**.



- Ensure that your HDDs have no existing RAID volumes.
- Ensure to connect your HDDs to Intel® SATA connectors.

3. Select the port that you want to set to [RAID] mode, **PCIe** or **SATA**, then click **Next**.

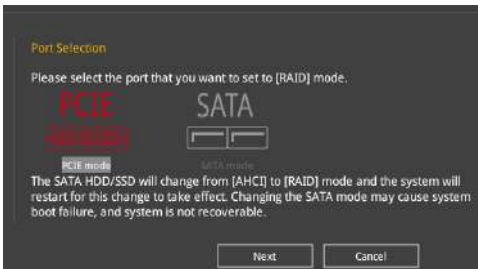

4. Select the type of storage for your RAID, **Easy Backup** or **Super Speed**, then click **Next**.



- a. For Easy Backup, click **Next** then select from **Easy Backup (RAID1)** or **Easy Backup (RAID10)**.



You can only select Easy Backup (RAID 10) if you connect four (4) HDDs.

- b. For Super Speed, click **Next** then select from **Super Speed (RAID0)** or **Super Speed (RAID5)**.



5. After selecting the type of RAID, click **Next** then click **Yes** to continue the RAID setup.
6. After the RAID setup is done, click **Yes** to exit the setup then click **OK** to reset your system.

### 3.3 My Favorites

My Favorites is your personal space where you can easily save and access your favorite BIOS items.

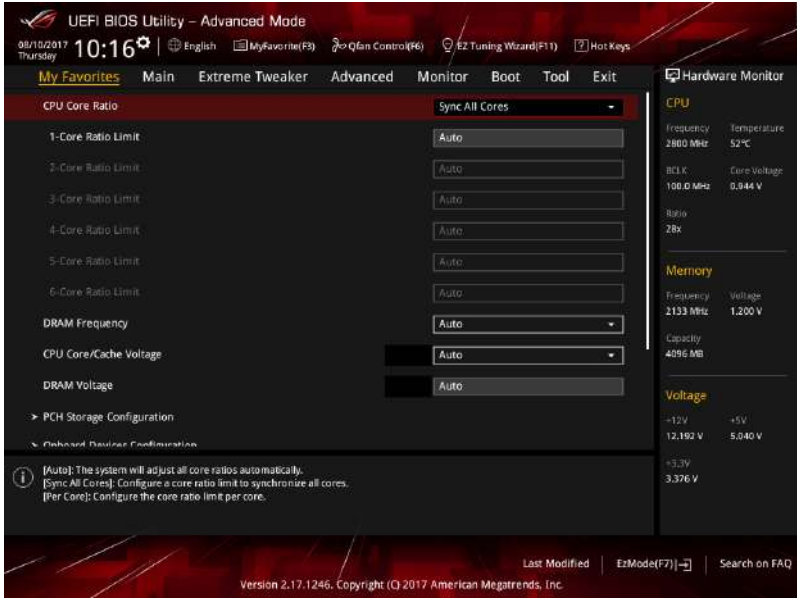

My Favorites comes with several performance, power saving, and fast boot related items by default. You can personalize this screen by adding or removing items.

## Adding items to My Favorites

To add BIOS items:

1. Press <F3> on your keyboard or click **MyFavorites(F3)** from the BIOS screen to open Setup Tree Map screen.
2. On the Setup Tree Map screen, select the BIOS items that you want to save in My Favorites screen.

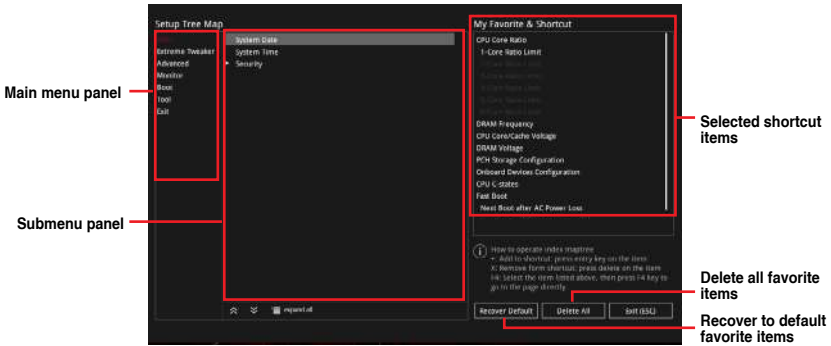

3. Select an item from main menu panel, then click the submenu that you want to save as favorite from the submenu panel and click **+** or press <Enter> on your keyboard.



You cannot add the following items to My Favorite items:

- Items with submenu options
- User-managed items such as language and boot order
- Configuration items such as Memory SPD Information, system time and date.

4. Click **Exit (ESC)** or press <Esc> key to close Setup Tree Map screen.
5. Go to My Favorites menu to view the saved BIOS items.

## 3.4 Main menu

The Main menu screen appears when you enter the Advanced Mode of the BIOS Setup program. The Main menu provides you an overview of the basic system information, and allows you to set the system date, time, language, and security settings.

### Security

The Security menu items allow you to change the system security settings.



- If you have forgotten your BIOS password, erase the CMOS Real Time Clock (RTC) RAM to clear the BIOS password. See section 1.1.6 **Onboard buttons and switches** for information on how to erase the RTC RAM via the Clear CMOS button.
- The Administrator or User Password items on top of the screen show the default **[Not Installed]**. After you set a password, these items show **[Installed]**.

## 3.5 Extreme Tweaker menu

The Extreme Tweaker menu items allow you to configure overclocking-related items.



Be cautious when changing the settings of the Extreme Tweaker menu items. Incorrect field values can cause the system to malfunction



The configuration options for this section vary depending on the CPU and DIMM model you installed on the motherboard.

### Ai Overclock Tuner

Allows you to select the CPU overclocking options to achieve the desired CPU internal frequency.

- |          |   |
|----------|---|
| [Auto]   | Loads the optimal settings for the system.  |
| [Manual] | Allows you to individually set overclocking parameters.   |
| [X.M.P.] | If you install memory modules supporting the eXtreme Memory Profile (X.M.P.) Technology, choose this item to set the profiles supported by your memory modules for optimizing the system performance. |



The [X.M.P.] configuration option appears only when you install memory modules supporting the eXtreme Memory Profile (X.M.P.) Technology.



The following item appears only when you set the **Ai Overclocking Tuner** to **[Manual]**.

#### BCLK Frequency

This item allows you to set the BCLK (base clock) frequency to enhance the system performance. Use the <+> or <-> to adjust the value. The values range from 40.0 MHz to 1000.0 MHz.



We recommend you to set the value based on the CPU specification, as high BCLK frequencies may damage the CPU permanently.

## ASUS MultiCore Enhancement

[Auto] This item allows you to maximize the overclocking performance optimized by ASUS core ratio settings.

[Disabled] This item allows you to set to default core ratio settings.

## CPU Core Ratio

This item allows you to set the CPU core ratios.

Configuration options: [Auto] [Sync All Cores] [By Core Usage]

## DRAM Frequency

This item allows you to set the memory operating frequency. The configurable options vary with the BCLK (base clock) frequency setting. Select the auto mode to apply the optimized setting.

Configuration options: [Auto] [DDR4-800MHz] - [DDR4-8533MHz]

## TPU

This item allows you to automatically overclock the CPU and DRAM frequencies and voltage for an enhanced system performance.

[Keep Current Settings] Keep the current settings without changing anything.

[TPU I] Applies air cooling overclocking conditions.

[TPU II] Applies water cooling overclocking conditions.



---

Ensure to use water cooling device before selecting [TPU II].

---

## Internal CPU Power Management

The subitems in this menu allow you to set the CPU ratio and features.

### Intel(R) SpeedStep(tm)

Allows the operating system to dynamically adjust the processor voltage and cores frequency to decrease the average power consumption and decrease average heat production.

Configuration options: [Auto] [Disabled] [Enabled]

### Turbo Mode

Allows you to enable your processor cores to run faster than the base operating frequency when it is below power, current and specification limit.

Configuration options: [Disabled] [Enabled]

## 3.6 Advanced menu

The Advanced menu items allow you to change the settings for the CPU and other system devices.



---

Be cautious when changing the settings of the Advanced menu items. Incorrect field values can cause the system to malfunction.

---

### 3.6.1 CPU Configuration

The items in this menu show the CPU-related information that the BIOS automatically detects.



---

The items in this menu may vary based on the CPU installed.

---

#### CPU Power Management Configuration

This item allows you to manage and configure the CPU's power.

##### Intel(R) SpeedStep(tm)

This item allows more than two frequency to be supported.

Configuration options: [Auto] [Enabled] [Disabled]

##### Turbo Mode

This item allows you to automatically set the CPU cores to run faster than the base operating frequency when it is below the operating power, current and temperature specification limit.

Configuration options: [Enabled] [Disabled]

##### CPU C-States

This item allows you to set the power saving of the CPU states.

Configuration options: [Auto] [Disabled] [Enabled]

### 3.6.2 Platform Misc Configuration

The items in this menu allow you to change the ASPM for PCH and SA PCI Express.

### 3.6.3 System Agent (SA) Configuration

The items in this menu allow you to adjust the Link Speed for PEG Port and Multi-Monitor.

### 3.6.4 PCH Configuration

The items in this menu allow you to adjust the PCH PCI Express speed.

#### PCI Express Configuration

This item allows you to configure the PCI Express slots.

##### PCIe Speed

This item allows your system to automatically select the PCI Express port speed.

Configuration options: [Auto] [Gen1] [Gen2] [Gen3]

### 3.6.5 PCH Storage Configuration

While entering Setup, the BIOS automatically detects the presence of SATA devices. The SATA Port items show **Empty** if no SATA device is installed to the corresponding SATA port.

#### SATA Controller(s)

This item allows you to enable or disable the SATA Device.

Configuration options: [Disabled] [Enabled]

#### SATA Mode Selection

This item allows you to set the SATA configuration.

[AHCI]	Set to [AHCI] when you want the SATA hard disk drives to use the AHCI (Advanced Host Controller Interface). The AHCI allows the onboard storage driver to enable advanced Serial ATA features that increases storage performance on random workloads by allowing the drive to internally optimize the order of commands.
[Intel RST Premium With Intel Optane System Acceleration (RAID)]	Set to [Intel RST Premium With Intel Optane System Acceleration (RAID)] when you want to create a RAID configuration from the SATA hard disk drives.

#### S.M.A.R.T. Status Check

S.M.A.R.T. (Self-Monitoring, Analysis and Reporting Technology) is a monitoring system that shows a warning message during POST (Power-on Self Test) when an error occurs in the hard disks.

Configuration options: [On] [Off]

#### SATA6G\_1(Gray) - SATA6G\_4(Gray)

##### SATA6G\_1(Gray) - SATA6G\_4(Gray)

This item allows you to enable or disable the selected SATA port.

Configuration options: [Disabled] [Enabled]

##### Hot Plug

These items appears only when the SATA Mode Selection is set to [AHCI] and allows you to enable or disable SATA Hot Plug Support.

Configuration options: [Disabled] [Enabled]

### 3.6.6 PCH-FW Configuration

This item allows you to configure the firmware TPM.

### 3.6.7 ROG Effects

The items in this menu allow you to configure the LEDs on your motherboard and the functions for the Q-Code LED.

#### Onboard LED

This item allows you to enable all the onboard LEDs.

Configuration options: [Enabled] [Disabled]

#### Q-Code LED Function

[Auto] Automatically display POST (Power-On Self-Test) code and CPU temperature on Q-Code LED.

[POST Code Only] Show POST (Power-On Self-Test) code on Q-Code LED.

### 3.6.8 Onboard Devices Configuration

The items in this menu allow you to switch between PCIe Lanes and configure onboard devices.

#### HD Audio Controller

This item allows you to use the High Definition Audio Controller.

Configuration options: [Disabled] [Enabled]

#### M.2\_2 Configuration: [Auto][SATA mode][PCIe mode]

[Auto] Auto-detects the M.2 device mode.

[SATA mode] Only supports M.2 SATA devices.

[PCIe mode] Only supports M.2 PCIe devices.

#### USB Type C Power Switch

[Auto] The system will automatically detect your USB Type C devices and provide suitable power if needed.

[Enabled] The USB Type C port will always provide power to your devices.

#### RGB LED lighting

##### When system is in working state

This item allows you to turn the RGB LED lighting on or off when the system is in the working state.

Configuration options: [On] [Off]

##### When system is in sleep, hibernate or soft off states

This item allows you to turn the RGB LED lighting on or off when the system is in the sleep, hibernate or soft off states.

Configuration options: [On] [Off]

#### 5G LAN Card

This item allows you to enable or disable the 5G LAN card.

Configuration options: [Disabled] [Enabled]

#### Intel LAN Controller

This item allows you to enable or disable the Intel LAN controllers.

Configuration options: [Disabled] [Enabled]

### 3.6.9 APM Configuration

The items in this menu allow you to set system wake and sleep settings.

#### ErP Ready

This item allows you to switch off some power at S4+S5 or S5 to get the system ready for ErP requirement. When set to **[Enabled]**, all other PME options are switched off.

Configuration options: [Disabled] [Enable(S4+S5)] [Enable(S5)]

### 3.6.10 Network Stack Configuration

The items in this menu allow you to configure Ipv4 / Ipv6 PXE support.

### 3.6.11 HDD/SSD SMART Information

This menu displays the SMART information of the connected devices.



---

NVM Express devices do not support SMART information.

---

### 3.6.12 USB Configuration

The items in this menu allow you to change the USB-related features.



---

The **Mass Storage Devices** item shows the auto-detected values. If no USB device is detected, the item shows **None**.

---

#### USB Single Port Control

This item allows you to enable or disable the individual USB ports.



---

Refer to section **1.1.2 Motherboard layout** for the location of the USB ports.

---

## 3.7 Monitor menu

The Monitor menu displays the system temperature/power status, and allows you to change the fan settings.

Scroll down to display the other BIOS items.

### Q-fan Configuration

#### Q-fan Tuning

Click this item to automatically detect the lowest speed and configure the minimum duty cycle for each fan.

#### AIO PUMP/W\_PUMP+ Control

- |            |  |
|------------|--|
| [Disabled] | Disable the Water Pump control feature.  |
| [Auto]     | Detects the type of water pump installed and automatically switches the control modes. |
| [DC mode]  | Enable the Water Pump control in DC mode for 3-pin chassis fan.                        |
| [PWM mode] | Enable the Water Pump control in PWM mode for 4-pin chassis fan.                       |

## 3.8 Boot menu

The Boot menu items allow you to change the system boot options.

### Fast Boot

- |            |   |
|------------|---|
| [Disabled] | Allows your system to go back to its normal boot speed. |
| [Enabled]  | Allows your system to accelerate the boot speed.        |



---

The following item appears only when you set the **Fast Boot** to **[Enabled]**.

---

#### Next Boot after AC Power Loss

- |               |   |
|---------------|---|
| [Normal Boot] | Returns to normal boot on the next boot after an AC power loss.     |
| [Fast Boot]   | Accelerates the boot speed on the next boot after an AC power loss. |

### Boot Configuration

#### Setup Mode

- |                 |   |
|-----------------|---|
| [Advanced Mode] | This item allows you to go to Advanced Mode of the BIOS after POST. |
| [EZ Mode]       | This item allows you to go to EZ Mode of the BIOS after POST.       |

## CSM (Compatibility Support Module)

This item allows you to configure the CSM (Compatibility Support Module) items to fully support the various VGA, bootable devices and add-on devices for better compatibility.



---

When CSM is disabled or set to run UEFI RAID driver only, the RAID set will not show up as a bootable device until an OS is installed.

---

### Launch CSM

- [Auto] The system automatically detects the bootable devices and the add-on devices.
- [Enabled] For better compatibility, enable the CSM to fully support the non-UEFI driver add-on devices or the Windows® UEFI mode.
- [Disabled] Disable the CSM to fully support the non-UEFI driver add-on devices or the Windows® UEFI mode.



---

The following items appear only when you set the **Launch CSM** to **[Enabled]**.

---

#### ***Boot Devices Control***

This item allows you to select the type of devices that you want to boot.

Configuration options: [UEFI and Legacy OPROM] [Legacy OPROM only] [UEFI only]

#### ***Boot from Network Devices***

This item allows you to select the type of network devices that you want to launch.

Configuration options: [Ignore] [Legacy only] [UEFI driver first]

#### ***Boot from Storage Devices***

This item allows you to select the type of storage devices that you want to launch.

Configuration options: [Ignore] [Legacy only] [UEFI driver first]

#### ***Boot from PCI-E/PCI Expansion Devices***

This item allows you to select the type of PCI-E/PCI expansion devices that you want to launch.

Configuration options: [Legacy only] [UEFI driver first]

## Secure Boot

This item allows you to configure the Windows® Secure Boot settings and manage its keys to protect the system from unauthorized access and malwares during POST.

## Boot Option Priorities

These items specify the boot device priority sequence from the available devices. The number of device items that appears on the screen depends on the number of devices installed in the system.



- To access Windows® OS in Safe Mode, press <F8> after POST (Windows® 8 not supported).
- To select the boot device during system startup, press <F8> when the ASUS Logo appears.

## Boot Override

These items displays the available devices. The number of device items that appears on the screen depends on the number of devices installed in the system. Click an item to start booting from the selected device.

## 3.9 Tool menu

The Tool menu items allow you to configure options for special functions. Select an item then press <Enter> to display the submenu.

### Setup Animator

This item allows you to enable or disable the Setup animator.

Configuration options: [Disabled] [Enabled]

### 3.9.1 ASUS EZ Flash 3 Utility

This item allows you to run ASUS EZ Flash 3. When you press <Enter>, a confirmation message appears. Use the left/right arrow key to select between [Yes] or [No], then press <Enter> to confirm your choice.



For more details, refer to section **3.11.2 ASUS EZ Flash 3**.

## 3.9.2 Secure Erase

SSD speeds may lower over time as with any storage medium due to data processing. Secure Erase completely and safely cleans your SSD, restoring it to factory performance levels.



Secure Erase is only available in AHCI mode. Ensure to set the SATA mode to AHCI. Click **Advanced > PCH Storage Configuration > SATA Mode Selection > AHCI**.

To launch Secure Erase, click **Tool > Secure Erase** on the Advanced mode menu.



Check the ASUS support site for a full list of SSDs tested with Secure Erase. The drive may become unstable if you run Secure Erase on an incompatible SSD.



- The time to erase the contents of your SSD may take a while depending on its size. Do not turn off the system during the process.
- Secure Erase is only supported on Intel SATA port. For more information about Intel SATA ports, refer to section 1.1.2 **Motherboard layout** of this manual.

Displays the available SSDs

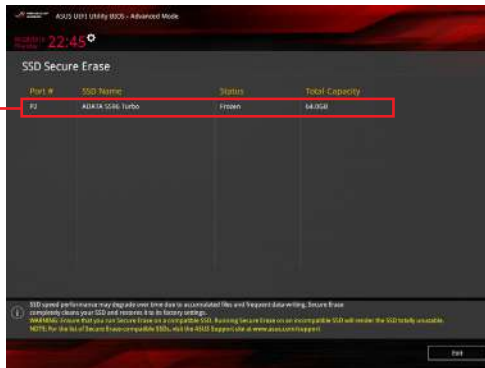

### Status definition:

- **Frozen.** The frozen state is the result of a BIOS protective measure. The BIOS guards drives that do not have password protection by freezing them prior to booting. If the drive is frozen, a power off or hard reset of your PC must be performed to proceed with the Secure Erase.
- **Locked.** SSDs might be locked if the Secure Erase process is either incomplete or was stopped. This may be due to a third party software that uses a different password defined by ASUS. You have to unlock the SSD in the software before proceeding with Secure Erase.

### 3.9.3 ASUS Overclocking Profile

This item allows you to store or load multiple BIOS settings.

#### Load from Profile

This item allows you to load the previous BIOS settings saved in the BIOS Flash. Key in the profile number that saved your BIOS settings, press <Enter>, and then select **Yes**.



- DO NOT shut down or reset the system while updating the BIOS to prevent the system boot failure!
- We recommend that you update the BIOS file only coming from the same memory/CPU configuration and BIOS version.

#### Profile Name

This item allows you to key in a profile name.

#### Save to Profile

This item allows you to save the current BIOS settings to the BIOS Flash, and create a profile. Key in a profile number from one to eight, press <Enter>, and then select **Yes**.

#### Load/Save Profile from/to USB Drive

This item allows you to load or save profile from your USB drive, load and save profile to your USB drive.

### 3.9.4 BIOS FlashBack

This item allows you to manage BIOS settings between BIOS chips.

### 3.9.5 ROG OC Panel H-Key Configure

The ROG OC Panel H-Key Configure allows you to input and save values on the CPU core voltage, VCCSA voltage, BCLK Frequency, CPU ratio, and Cache ratio in the UEFI BIOS. The saved values can be synchronized to a compatible OC Panel device and these values can be tweaked or configured using the OC Panel without going to the BIOS menu.

#### Load Default

This item allows you to load the default values of the CPU Core Voltage, VCCSA Voltage, BCLK Frequency, CPU ratio, and Cache ratio.

#### Save Above Settings

This item allows you to save the new values of the CPU Core Voltage, VCCSA Voltage, BCLK Frequency, CPU ratio, and Cache ratio.

#### Load from profile

This item allows you to load the previous values of the CPU Core Voltage, VCCSA Voltage, BCLK Frequency, CPU ratio, and Cache ratio.

### 3.9.6 ASUS SPD Information

This item allows you to view the DRAM SPD information.

### 3.9.7 Graphics Card Information

This item displays the information about the graphics card installed in your system.

#### GPU Post

This item displays the information and recommended configuration for the PCIe slots that the graphics card is installed in your system.



---

This feature is only supported on selected ASUS graphics cards.

---

#### Bus Interface

This item allows you to select the bus interface.

Configuration options: [PCIEX16/X8\_1]

## 3.10 Exit menu

The Exit menu items allow you to load the optimal default values for the BIOS items, and save or discard your changes to the BIOS items. You can access the EZ Mode from the Exit menu.

#### Load Optimized Defaults

This option allows you to load the default values for each of the parameters on the Setup menus. When you select this option or if you press <F5>, a confirmation window appears. Select **OK** to load the default values.

#### Save Changes & Reset

Once you are finished making your selections, choose this option from the Exit menu to ensure the values you selected are saved. When you select this option or if you press <F10>, a confirmation window appears. Select **OK** to save changes and exit.

#### Discard Changes & Exit

This option allows you to exit the Setup program without saving your changes. When you select this option or if you press <Esc>, a confirmation window appears. Select **Yes** to discard changes and exit.

#### Launch EFI Shell from USB drives

This item allows you to attempt to launch the EFI Shell application (shellx64.efi) from one of the available filesystem devices.

## 3.11 Updating BIOS

The ASUS website publishes the latest BIOS versions to provide enhancements on system stability, compatibility, and performance. However, BIOS updating is potentially risky. If there is no problem using the current version of BIOS, DO NOT manually update the BIOS. Inappropriate BIOS updating may result to system's failure to boot. Carefully follow the instructions in this chapter to update your BIOS when necessary.



---

Visit <http://www.asus.com> to download the latest BIOS file for this motherboard.

---

The following utilities allow you to manage and update the motherboard BIOS setup program.

1. EZ Update: Updates the BIOS in Windows® environment.
2. ASUS EZ Flash 3: Updates the BIOS using a USB flash drive.
3. ASUS CrashFree BIOS 3: Restores the BIOS using the motherboard support DVD or a USB flash drive when the BIOS file fails or gets corrupted.

### 3.11.1 EZ Update

The EZ Update is a utility that allows you to update the motherboard BIOS in Windows® environment.



- 
- EZ Update requires an Internet connection either through a network or an ISP (Internet Service Provider).
  - This utility is available in the support DVD that comes with the motherboard package.
-

### 3.11.2 ASUS EZ Flash 3

ASUS EZ Flash 3 allows you to download and update to the latest BIOS through the Internet without having to use a bootable floppy disk or an OS-based utility.



Updating through the Internet varies per region and Internet conditions. Check your local Internet connection before updating through the Internet.

#### To update the BIOS by USB:

1. Enter the Advanced Mode of the BIOS setup program. Go to the Tool menu to select **ASUS EZ Flash 3 Utility** and press <Enter>.
2. Insert the USB flash disk that contains the latest BIOS file to the USB port.
3. Select **via Storage Device(s)**.

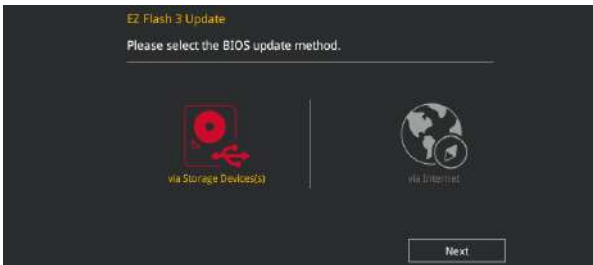

4. Press the Up/Down arrow keys to find the USB flash disk that contains the latest BIOS, and then press <Enter>.
5. Press the Up/Down arrow keys to find the BIOS file, and then press <Enter> to perform the BIOS update process. Reboot the system when the update process is done.

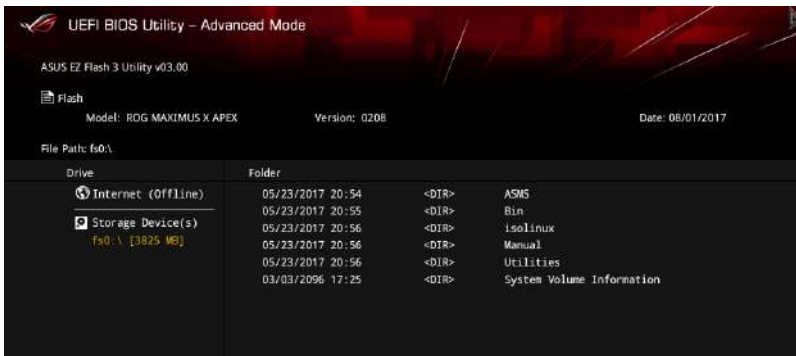



- This function can support devices such as a USB flash disk with FAT 32/16 format and single partition only.
- DO NOT shut down or reset the system while updating the BIOS to prevent system boot failure!



Ensure to load the BIOS default settings to ensure system compatibility and stability. Select the Load Optimized Defaults item under the Exit menu. See section 3.10 **Exit Menu** for details.

### To update the BIOS by Internet:

1. Enter the Advanced Mode of the BIOS setup program. Go to the Tool menu to select **ASUS EZ Flash 3 Utility** and press <Enter>.
2. Select **via Internet**.

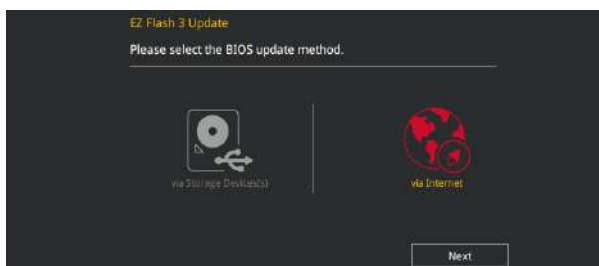

3. Press the Left/Right arrow keys to select an Internet connection method, and then press <Enter>.



4. Follow the onscreen instructions to complete the update.
5. Reboot the system when the update process is done.



Ensure to load the BIOS default settings to ensure system compatibility and stability. Select the Load Optimized Defaults item under the Exit menu. See section 3.10 **Exit Menu** for details.

### 3.11.3 ASUS CrashFree BIOS 3

The ASUS CrashFree BIOS 3 utility is an auto recovery tool that allows you to restore the BIOS file when it fails or gets corrupted during the updating process. You can restore a corrupted BIOS file using the motherboard support DVD or a USB flash drive that contains the BIOS file.



---

The BIOS file in the motherboard support DVD may be older than the BIOS file published on the ASUS official website. If you want to use the newer BIOS file, download the file at <https://www.asus.com/support/> and save it to a USB flash drive.

---

#### Recovering the BIOS

##### To recover the BIOS:

1. Turn on the system.
2. Insert the motherboard support DVD to the optical drive, or the USB flash drive containing the BIOS file to the USB port.
3. The utility automatically checks the devices for the BIOS file. When found, the utility reads the BIOS file and enters ASUS EZ Flash 3 automatically.
4. The system requires you to enter BIOS Setup to recover the BIOS setting. To ensure system compatibility and stability, we recommend that you press <F5> to load default BIOS values.



---

**DO NOT** shut down or reset the system while updating the BIOS! Doing so can cause system boot failure!

---



# RAID Support

# 4

## 4.1 RAID configurations

The motherboard supports Intel® Rapid Storage Technology with RAID 0, RAID 1, RAID 5, and RAID 10 solution.



---

If you want to install a Windows® operating system to a hard disk drive included in a RAID set, you have to create a RAID driver disk and load the RAID driver during OS installation. Refer to section 4.2 **Creating a RAID driver disk** for details.

---

### 4.1.1 RAID definitions

**RAID 0 (Data striping)** optimizes two identical hard disk drives to read and write data in parallel, interleaved stacks. Two hard disks perform the same work as a single drive but at a sustained data transfer rate, double that of a single disk alone, thus improving data access and storage. Use of two new identical hard disk drives is required for this setup.

**RAID 1 (Data mirroring)** copies and maintains an identical image of data from one drive to a second drive. If one drive fails, the disk array management software directs all applications to the surviving drive as it contains a complete copy of the data in the other drive. This RAID configuration provides data protection and increases fault tolerance to the entire system. Use two new drives or use an existing drive and a new drive for this setup. The new drive must be of the same size or larger than the existing drive.

**RAID 5** stripes both data and parity information across three or more hard disk drives. Among the advantages of RAID 5 configuration include better HDD performance, fault tolerance, and higher storage capacity. The RAID 5 configuration is best suited for transaction processing, relational database applications, enterprise resource planning, and other business systems. Use a minimum of three identical hard disk drives for this setup.

**RAID 10** is data striping and data mirroring combined without parity (redundancy data) having to be calculated and written. With the RAID 10 configuration you get all the benefits of both RAID 0 and RAID 1 configurations. Use four new hard disk drives or use an existing drive and three new drives for this setup.

## 4.1.2 Installing Serial ATA hard disks

The motherboard supports Serial ATA hard disk drives. For optimal performance, install identical drives of the same model and capacity when creating a disk array.

### To install the SATA hard disks for a RAID configuration:

1. Install the SATA hard disks into the drive bays.
2. Connect the SATA signal cables.
3. Connect a SATA power cable to the power connector on each drive.

## 4.1.3 Intel® Rapid Storage Technology in UEFI BIOS

To enter the Intel® Rapid Storage Technology in UEFI BIOS:

1. Enter the BIOS Setup during POST.
2. Go to the **Advanced** menu > **PCH Storage Configuration**, then press <Enter>.
3. Set the SATA Controller Mode Selection item to **[Intel RST Premium With Intel Optane System Acceleration (RAID)]**.
4. Go to the **Boot** menu > **CSM (Compatibility Support Module)** > **Launch CSM**, then set the item to **[Disabled]**.
5. Save your changes and exit the BIOS Setup, then enter the BIOS Setup again.
6. Go to the **Advanced** menu > **Intel(R) Rapid Storage Technology**, then press <Enter> to display the Intel® Rapid Storage Technology menu.



Refer to Chapter 3 for details on entering and navigating through the BIOS Setup



Due to chipset limitation, when SATA ports are set to RAID mode, all SATA ports run at RAID mode together.



## Creating a RAID set

To create a RAID set:

1. From the Intel® Rapid Storage Technology menu, select **Create RAID Volume** and press <Enter>. The following screen appears:

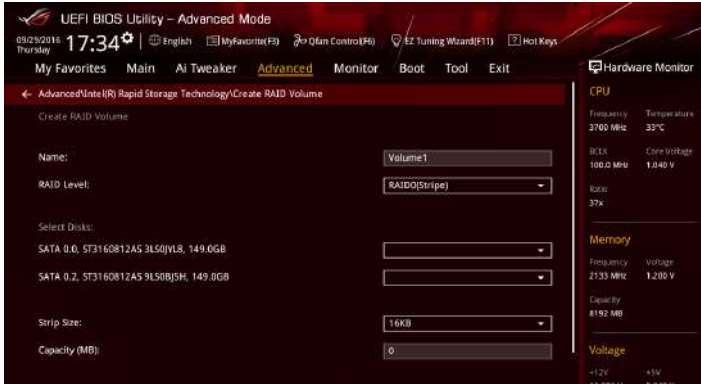

2. When the Name item is selected, enter a name for the RAID set and press <Enter>.
3. When the RAID Level item is selected, press <Enter> to select the RAID level to create, and then press <Enter>.
4. Under Select Disks, press <Enter> and select **X** for the disks you want to include in the RAID set.

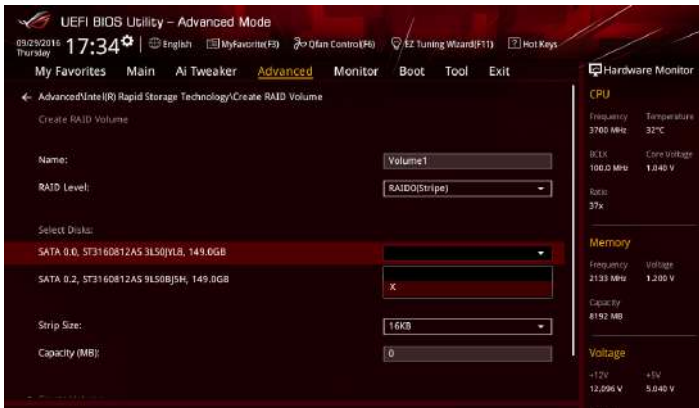

5. When the Strip Size item is selected, press <Enter> to select strip size for the RAID array (for RAID 0, 10 and 5 only), and then press <Enter>. The available strip size values range from 4 KB to 128 KB. The following are typical values:
  - RAID 0: 128 KB
  - RAID 10: 64 KB
  - RAID 5: 64 KB



We recommend a lower strip size for server systems, and a higher strip size for multimedia computer systems used mainly for audio and video editing.

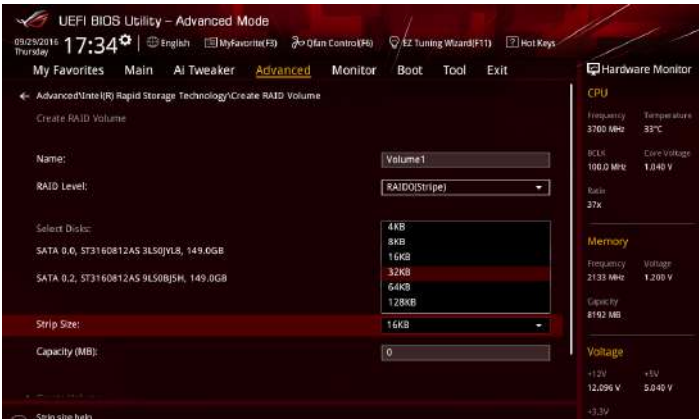

6. When the **Capacity (MB)** item is selected, enter the RAID volume capacity that you want and press <Enter>. The default value indicates the maximum allowed capacity.
7. When the **Create Volume** item is selected, press <Enter> to create the RAID volume and return to the Intel® Rapid Storage Technology menu.

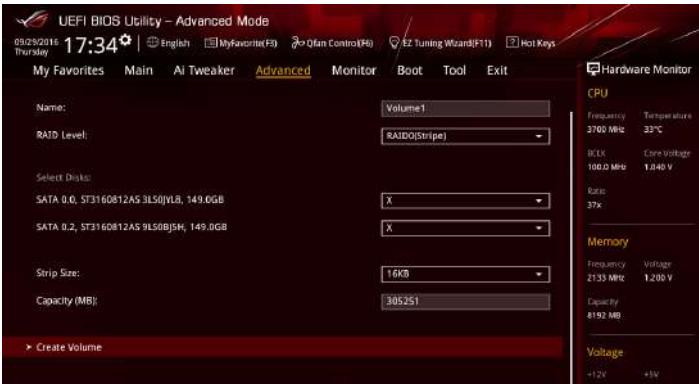

## Deleting a RAID set



Be cautious when deleting a RAID set. You will lose all data on the hard disk drives when you delete a RAID set.

To delete a RAID set:

1. From the Intel® Rapid Storage Technology menu, select the RAID volume you want to delete and press <Enter>. The following screen appears:



2. When the **Delete** item is selected, press <Enter>, then select **Yes** to delete the RAID volume and return to the Intel® Rapid Storage Technology menu, or select **No** to cancel.

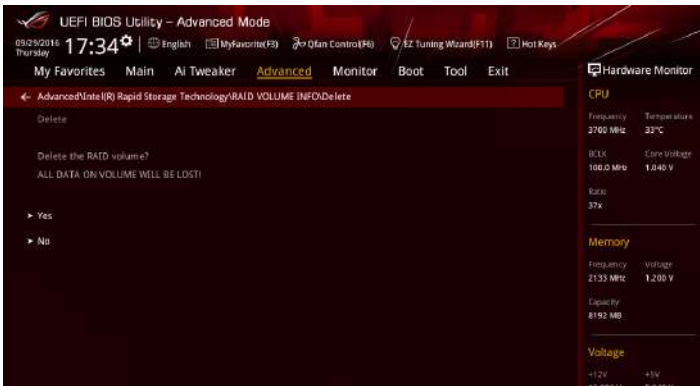

## 4.1.4 Intel® Rapid Storage Technology Option ROM utility

To enter the Intel® Rapid Storage Technology Option ROM utility:

1. Turn on the system.
2. During POST, press <Ctrl> + <I> to display the utility main menu.

```
Intel(R) Rapid Storage Technology - Option - v10.5.1.1070
Copyright(C) 2003-14 Intel Corporation. All Rights Reserved.

[ MAIN MENU ]

1. Create RAID Volume          4. Recovery Volume Options
2. Delete RAID Volume         5. Acceleration Options
3. Reset Disks to Non-RAID    6. Exit

[ DISK/VOLUME INFORMATION ]

RAID Volumes:
None defined.

Physical Devices:
Port  Device Model  Serial #      Size   Type/Status(Vol ID)
0     ST3160812AS     9LS0HJA4     149.0GB Non-RAID Disk
1     ST3160812AS     9LS0F4HL     149.0GB Non-RAID Disk
2     ST3160812AS     3LS0JYL8     149.0GB Non-RAID Disk
3     ST3160812AS     9LS0BJ5H     149.0GB Non-RAID Disk

[↑↓]-Select      [ESC]-Exit      [ENTER]-Select Menu
```

The navigation keys at the bottom of the screen allow you to move through the menus and select the menu options.



The RAID BIOS setup screens shown in this section are for reference only and may not exactly match the items on your screen.



The utility supports maximum four hard disk drives for RAID configuration.

## Creating a RAID set

### To create a RAID set:

1. From the utility main menu, select **1. Create RAID Volume** and press <Enter>. The following screen appears:

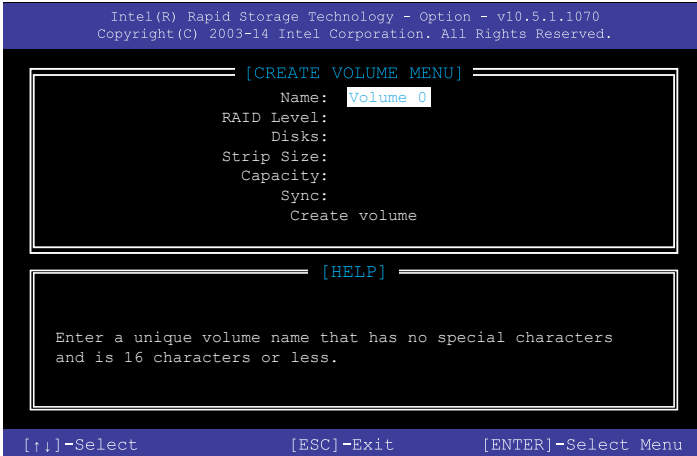

2. Enter a name for the RAID set and press <Enter>.
3. When the RAID Level item is selected, press the up/down arrow key to select a RAID level to create, and then press <Enter>.
4. When the Disks item is selected, press <Enter> to select the hard disk drives you want to include in the RAID set. The SELECT DISKS screen appears:

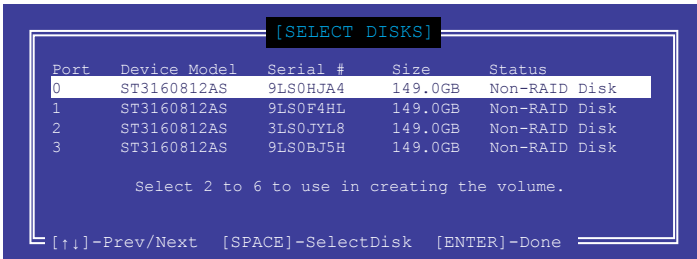

5. Use the up/down arrow key to select a drive, and then press <Space> to select. A small triangle marks the selected drive. Press <Enter> after completing your selection.
6. Use the up/down arrow key to select the strip size for the RAID array (for RAID 0, 10 and 5 only), and then press <Enter>. The available strip size values range from 4KB to 128KB. The following are typical values:
  - RAID 0: 128KB
  - RAID 10: 64KB
  - RAID 5: 64KB



---

We recommend a lower strip size for server systems, and a higher strip size for multimedia computer systems used mainly for audio and video editing.

---

7. When the **Capacity** item is selected, enter the RAID volume capacity that you want and press <Enter>. The default value indicates the maximum allowed capacity.
8. When the **Create Volume** item is selected, press <Enter>. The following warning message appears:

WARNING: ALL DATA ON SELECTED DISKS WILL BE LOST.  
Are you sure you want to create this volume? (Y/N)

9. Press <Y> to create the RAID volume and return to the main menu, or <N> to go back to the CREATE VOLUME menu.

## Deleting a RAID set



Be cautious when deleting a RAID set. You will lose all data on the hard disk drives when you delete a RAID set.

To delete a RAID set:

1. From the utility main menu, select **2. Delete RAID Volume** and press <Enter>. The following screen appears:

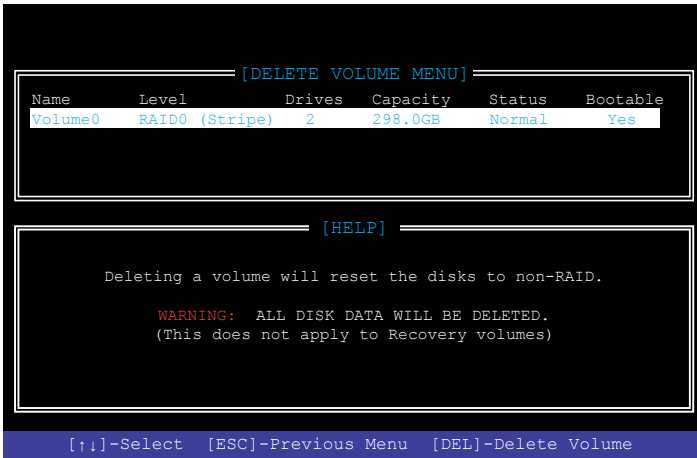

2. Use the up/down arrow key to select the RAID set you want to delete, and then press <Delete>. The following warning message appears:



3. Press <Y> to delete the RAID set and return to the utility main menu, or press <N> to return to the DELETE VOLUME menu.

## Exiting the Intel® Rapid Storage Technology Option ROM utility

### To exit the utility:

1. From the utility main menu, select **5. Exit**, and then press <Enter>. The following warning message appears:

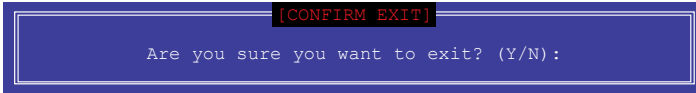

2. Press <Y> to exit or press <N> to return to the utility main menu.

## 4.2 Creating a RAID driver disk

### 4.2.1 Creating a RAID driver disk in Windows®

#### To install the RAID driver for Windows® OS:

1. During the OS installation, click **Load Driver** to allow you to select the installation media containing the RAID driver.
2. Insert the support USB drive with RAID driver into the USB port, and then click **Browse**.
3. Click the name of the device you've inserted, go to **Drivers > RAID**, and then select the RAID driver for the corresponding OS version. Click **OK**.
4. Follow the succeeding screen instructions to complete the installation.



---

To set up a Windows® UEFI operating system under RAID mode, ensure to load the UEFI driver for your optical drive.

---

# Appendix

## Q-Code table

Code	Description
00	Not used
01	Power on. Reset type detection (soft/hard).
02	AP initialization before microcode loading
03	System Agent initialization before microcode loading
04	PCH initialization before microcode loading
06	Microcode loading
07	AP initialization after microcode loading
08	System Agent initialization after microcode loading
09	PCH initialization after microcode loading
0B	Cache initialization
0C – 0D	Reserved for future AMI SEC error codes
0E	Microcode not found
0F	Microcode not loaded
10	PEI Core is started
11 – 14	Pre-memory CPU initialization is started
15 – 18	Pre-memory System Agent initialization is started
19 – 1C	Pre-memory PCH initialization is started
2B – 2F	Memory initialization
30	Reserved for ASL (see ASL Status Codes section below)
31	Memory Installed
32 – 36	CPU post-memory initialization
37 – 3A	Post-Memory System Agent initialization is started
3B – 3E	Post-Memory PCH initialization is started
4F	DXE IPL is started
50 – 53	Memory initialization error. Invalid memory type or incompatible memory speed
54	Unspecified memory initialization error
55	Memory not installed
56	Invalid CPU type or Speed
57	CPU mismatch
58	CPU self test failed or possible CPU cache error
59	CPU micro-code is not found or micro-code update is failed
5A	Internal CPU error
5B	Reset PPI is not available
5C – 5F	Reserved for future AMI error codes

*(continued on the next page)*

## Q-Code table

Code	Description
E0	S3 Resume is started (S3 Resume PPI is called by the DXE IPL)
E1	S3 Boot Script execution
E2	Video repost
E3	OS S3 wake vector call
E4 – E7	Reserved for future AMI progress codes
E8	S3 Resume Failed
E9	S3 Resume PPI not Found
EA	S3 Resume Boot Script Error
EB	S3 OS Wake Error
EC – EF	Reserved for future AMI error codes
F0	Recovery condition triggered by firmware (Auto recovery)
F1	Recovery condition triggered by user (Forced recovery)
F2	Recovery process started
F3	Recovery firmware image is found
F4	Recovery firmware image is loaded
F5 – F7	Reserved for future AMI progress codes
F8	Recovery PPI is not available
F9	Recovery capsule is not found
FA	Invalid recovery capsule
FB – FF	Reserved for future AMI error codes
60	DXE Core is started
61	NVRAM initialization
62	Installation of the PCH Runtime Services
63 – 67	CPU DXE initialization is started
68	PCI host bridge initialization
69	System Agent DXE initialization is started
6A	System Agent DXE SMM initialization is started
6B – 6F	System Agent DXE initialization (System Agent module specific)
70	PCH DXE initialization is started
71	PCH DXE SMM initialization is started
72	PCH devices initialization
73 – 77	PCH DXE Initialization (PCH module specific)
78	ACPI module initialization
79	CSM initialization
7A – 7F	Reserved for future AMI DXE codes

*(continued on the next page)*

## Q-Code table

Code	Description
90	Boot Device Selection (BDS) phase is started
91	Driver connecting is started
92	PCI Bus initialization is started
93	PCI Bus Hot Plug Controller Initialization
94	PCI Bus Enumeration
95	PCI Bus Request Resources
96	PCI Bus Assign Resources
97	Console Output devices connect
98	Console input devices connect
99	Super IO Initialization
9A	USB initialization is started
9B	USB Reset
9C	USB Detect
9D	USB Enable
9E – 9F	Reserved for future AMI codes
A0	IDE initialization is started
A1	IDE Reset
A2	IDE Detect
A3	IDE Enable
A4	SCSI initialization is started
A5	SCSI Reset
A6	SCSI Detect
A7	SCSI Enable
A8	Setup Verifying Password
A9	Start of Setup
AA	Reserved for ASL (see ASL Status Codes section below)
AB	Setup Input Wait
AC	Reserved for ASL (see ASL Status Codes section below)
AD	Ready To Boot event
AE	Legacy Boot event
AF	Exit Boot Services event
B0	Runtime Set Virtual Address MAP Begin
B1	Runtime Set Virtual Address MAP End
B2	Legacy Option ROM Initialization
B3	System Reset

*(continued on the next page)*

## Q-Code table

Code	Description
B4	USB hot plug
B5	PCI bus hot plug
B6	Clean-up of NVRAM
B7	Configuration Reset (reset of NVRAM settings)
B8– BF	Reserved for future AML codes
D0	CPU initialization error
D1	System Agent initialization error
D2	PCH initialization error
D3	Some of the Architectural Protocols are not available
D4	PCI resource allocation error. Out of Resources
D5	No Space for Legacy Option ROM
D6	No Console Output Devices are found
D7	No Console Input Devices are found
D8	Invalid password
D9	Error loading Boot Option (LoadImage returned error)
DA	Boot Option is failed (StartImage returned error)
DB	Flash update is failed
DC	Reset protocol is not available

### ACPI/ASL Checkpoints (under OS)

Code	Description
03	System is entering S3 sleep state
04	System is entering S4 sleep state
05	System is entering S5 sleep state
30	System is waking up from the S3 sleep state
40	System is waking up from the S4 sleep state
AC	System has transitioned into ACPI mode. Interrupt controller is in PIC mode.
AA	System has transitioned into ACPI mode. Interrupt controller is in APIC mode.

## Notices

### Federal Communications Commission Statement

This device complies with Part 15 of the FCC Rules. Operation is subject to the following two conditions:

- This device may not cause harmful interference.
- This device must accept any interference received including interference that may cause undesired operation.

This equipment has been tested and found to comply with the limits for a Class B digital device, pursuant to Part 15 of the FCC Rules. These limits are designed to provide reasonable protection against harmful interference in a residential installation. This equipment generates, uses and can radiate radio frequency energy and, if not installed and used in accordance with manufacturer's instructions, may cause harmful interference to radio communications. However, there is no guarantee that interference will not occur in a particular installation. If this equipment does cause harmful interference to radio or television reception, which can be determined by turning the equipment off and on, the user is encouraged to try to correct the interference by one or more of the following measures:

- Reorient or relocate the receiving antenna.
- Increase the separation between the equipment and receiver.
- Connect the equipment to an outlet on a circuit different from that to which the receiver is connected.
- Consult the dealer or an experienced radio/TV technician for help.



---

The use of shielded cables for connection of the monitor to the graphics card is required to assure compliance with FCC regulations. Changes or modifications to this unit not expressly approved by the party responsible for compliance could void the user's authority to operate this equipment.

---

## Compliance Statement of Innovation, Science and Economic Development Canada (ISED)

This device complies with Innovation, Science and Economic Development Canada licence exempt RSS standard(s). Operation is subject to the following two conditions: (1) this device may not cause interference, and (2) this device must accept any interference, including interference that may cause undesired operation of the device.

Operation in the band 5150–5250 MHz is only for indoor use to reduce the potential for harmful interference to co-channel mobile satellite systems.

CAN ICES-3(B)/NMB-3(B)

## Déclaration de conformité de Innovation, Sciences et Développement économique Canada (ISED)

Le présent appareil est conforme aux CNR d'Innovation, Sciences et Développement économique Canada applicables aux appareils radio exempts de licence. L'exploitation est autorisée aux deux conditions suivantes : (1) l'appareil ne doit pas produire de brouillage, et (2) l'utilisateur de l'appareil doit accepter tout brouillage radioélectrique subi, même si le brouillage est susceptible d'en compromettre le fonctionnement.

La bande 5150–5250 MHz est réservée uniquement pour une utilisation à l'intérieur afin de réduire les risques de brouillage préjudiciable aux systèmes de satellites mobiles utilisant les mêmes canaux.

CAN ICES-3(B)/NMB-3(B)

## VCCI: Japan Compliance Statement

### Class B ITE

この装置は、クラス B 情報技術装置です。この装置は、家庭環境で使用することを目的としていますが、この装置がラジオやテレビジョン受信機に近接して使用されると、受信障害を引き起こすことがあります。

取扱説明書に従って正しい取り扱いをして下さい。

VCCI-B

## KC: Korea Warning Statement

B급 기기 (가정용 방송통신기자재)

이 기기는 가정용(B급) 전자파적합기기로서 주로 가정에서 사용하는 것을 목적으로 하며, 모든 지역에서 사용할 수 있습니다.

## REACH

Complying with the REACH (Registration, Evaluation, Authorisation, and Restriction of Chemicals) regulatory framework, we published the chemical substances in our products at ASUS REACH website at <http://csr.asus.com/english/REACH.htm>.



DO NOT throw the motherboard in municipal waste. This product has been designed to enable proper reuse of parts and recycling. This symbol of the crossed out wheeled bin indicates that the product (electrical and electronic equipment) should not be placed in municipal waste. Check local regulations for disposal of electronic products.



DO NOT throw the mercury-containing button cell battery in municipal waste. This symbol of the crossed out wheeled bin indicates that the battery should not be placed in municipal waste.

## ASUS Recycling/Takeback Services

ASUS recycling and takeback programs come from our commitment to the highest standards for protecting our environment. We believe in providing solutions for you to be able to responsibly recycle our products, batteries, other components as well as the packaging materials. Please go to <http://csr.asus.com/english/Takeback.htm> for detailed recycling information in different regions.

## Regional notice for California



### WARNING

Cancer and Reproductive Harm -  
[www.P65Warnings.ca.gov](http://www.P65Warnings.ca.gov)

## Google™ License Terms

Copyright© 2017 Google Inc. All Rights Reserved.

Licensed under the Apache License, Version 2.0 (the "License"); you may not use this file except in compliance with the License. You may obtain a copy of the License at:

<http://www.apache.org/licenses/LICENSE-2.0>

Unless required by applicable law or agreed to in writing, software distributed under the License is distributed on an "AS IS" BASIS, WITHOUT WARRANTIES OR CONDITIONS OF ANY KIND, either express or implied.

See the License for the specific language governing permissions and limitations under the License.

**English** ASUSTeK Computer Inc. hereby declares that this device is in compliance with the essential requirements and other relevant provisions of related Directives. Full text of EU declaration of conformity is available at: [www.asus.com/support](http://www.asus.com/support)

**Français** AsusTek Computer Inc. déclare par la présente que cet appareil est conforme aux critères essentiels et autres clauses pertinentes des directives concernées. La déclaration de conformité de l'UE peut être téléchargée à partir du site Internet suivant: [www.asus.com/support](http://www.asus.com/support)

**Deutsch** ASUSTeK Computer Inc. erklärt hiermit, dass dieses Gerät mit den wesentlichen Anforderungen und anderen relevanten Bestimmungen der zugehörigen Richtlinien übereinstimmt. Der gesamte Text der EU-Konformitätserklärung ist verfügbar unter: [www.asus.com/support](http://www.asus.com/support)

**Italiano** ASUSTeK Computer Inc. con la presente dichiara che questo dispositivo è conforme ai requisiti essenziali e alle altre disposizioni pertinenti con le direttive correlate. Il testo completo della dichiarazione di conformità UE è disponibile all'indirizzo: [www.asus.com/support](http://www.asus.com/support)

**Русский** Компания ASUS заявляет, что это устройство соответствует основным требованиям и другим соответствующим условиям соответствующих директив. Подробную информацию, пожалуйста, смотрите на [www.asus.com/support](http://www.asus.com/support)

**Български** С настоящото ASUSTEK Computer Inc. декларира, че това устройство е в съответствие със съществениите изисквания и другите приложими постановления на свързаните директиви. Пълният текст на декларацията за съответствие на ЕС е достъпен на адрес: [www.asus.com/support](http://www.asus.com/support)

**Hrvatski** ASUSTeK Computer Inc. ovim izjavljuje da je ovaj uređaj sukladan s bitnim zahtjevima i ostalim odgovarajućim odredbama vezanih direktiva. Cijeli tekst EU izjave o sukladnosti dostupan je na: [www.asus.com/support](http://www.asus.com/support)

**Čeština** Společnost ASUSTeK Computer Inc. tímto prohlašuje, že toto zařízení splňuje základní požadavky a další příslušná ustanovení souvisejících směrnic. Plné znění prohlášení o shodě EU je k dispozici na adrese: [www.asus.com/support](http://www.asus.com/support)

**Dansk** ASUSTeK Computer Inc. erklærer hermed, at denne enhed er i overensstemmelse med hovedkravene og andre relevante bestemmelser i de relaterede direktiver. Hele EU-overensstemmelseserklæringen kan findes på: [www.asus.com/support](http://www.asus.com/support)

**Nederlands** ASUSTeK Computer Inc. verklaart hierbij dat dit apparaat voldoet aan de essentiële vereisten en andere relevante bepalingen van de verwante richtlijnen. De volledige tekst van de EU-verklaring van conformiteit is beschikbaar op: [www.asus.com/support](http://www.asus.com/support)

**Eesti** Käesolevaga kinnitab ASUSTeK Computer Inc, et see seade vastab asjakohaste direktiivide olulistele nõuetele ja teistele asjassepuutuvatele sätetele. El vastavusdeklaratsiooni täielik tekst on saadaval järgmisel aadressil: [www.asus.com/support](http://www.asus.com/support)

**Suomi** ASUSTeK Computer Inc. ilmoittaa täten, että tämä laite on asiaankuuluvien direktiivien olennaisten vaatimusten ja muiden tätä koskevien säädösten mukainen. EU-yhdenmukaisuusilmoituksen koko teksti on luettavissa osoitteessa: [www.asus.com/support](http://www.asus.com/support)

**Ελληνικά** Με το παρόν, η AsusTek Computer Inc. δηλώνει ότι αυτή η συσκευή συμμορφώνεται με τις θεμελιώδεις απαιτήσεις και άλλες σχετικές διατάξεις των Οδηγιών της ΕΕ. Το πλήρες κείμενο της δήλωσης συμμόρφωσης είναι διαθέσιμο στη διεύθυνση: [www.asus.com/support](http://www.asus.com/support)

**Magyar** Az ASUSTeK Computer Inc. ezennel kijelenti, hogy ez az eszköz megfelel a kapcsolódó irányelvek lényeges követelményeinek és egyéb vonatkozó rendelkezéseinek. Az EU megfélelősegi nyilatkozat teljes szövege innen letölthető: [www.asus.com/support](http://www.asus.com/support)

**Latviski** ASUSTeK Computer Inc. ar šo paziņo, ka šī ierīce atbilst saistošo Direktīvu būtiskajām prasībām un citiem citiem saistošajiem nosacījumiem. Pilns ES atbilstības paziņojuma teksts pieejams šeit: [www.asus.com/support](http://www.asus.com/support)

**Lietuvių** „ASUSTeK Computer Inc.“ šiuo tvirtina, kad šis įrenginys atitinka pagrindinius reikalavimus ir kitas svarbias susijusių direktyvų nuostatas. Visą ES atitikties deklaracijos tekstą galima rasti: [www.asus.com/support](http://www.asus.com/support)

**Norsk** ASUSTeK Computer Inc. erklærer herved at denne enheten er i samsvar med hovedsaklige krav og andre relevante forskrifter i relaterede direktiver. Fullstendig tekst for EU-samsvarserklæringen finnes på: [www.asus.com/support](http://www.asus.com/support)

**Polski** Firma ASUSTeK Computer Inc. niniejszym oświadcza, że urządzenie to jest zgodne z zasadniczymi wymogami i innymi właściwymi postanowieniami powiązanych dyrektyw. Pełny tekst deklaracji zgodności UE jest dostępny pod adresem: [www.asus.com/support](http://www.asus.com/support)

**Português** A ASUSTeK Computer Inc. declara que este dispositivo está em conformidade com os requisitos essenciais e outras disposições relevantes das Diretivas relacionadas. Texto integral da declaração da UE disponível em: [www.asus.com/support](http://www.asus.com/support)

**Română** ASUSTeK Computer Inc. declară că acest dispozitiv se conformează cerințelor esențiale și altor prevederi relevante ale directivelor conexe. Textul complet al declarației de conformitate a Uniunii Europene se găsește la: [www.asus.com/support](http://www.asus.com/support)

**Srpski** ASUSTeK Computer Inc. ovim izjavljuje da je ovaj uređaj u saglasnosti sa osnovnim zahtevima i drugim relevantnijim odredbama povezanih Direktiva. Pun tekst EU deklaracije o usaglasjenosti je dostupan da adres: [www.asus.com/support](http://www.asus.com/support)

**Slovensky** Spoločnosť ASUSTeK Computer Inc. týmto vyhlasuje, že toto zariadenie vyhovuje základným požiadavkám a ostatým príslušným ustanoveniam príslušných smerníc. Celý text vyhlásenia o zhode pre štáty EÚ je dostupný na adrese: [www.asus.com/support](http://www.asus.com/support)

**Slovenščina** ASUSTeK Computer Inc. izjavlja, da je ta naprava skladna z bistvenimi zahtevami in drugimi ustreznimi določbami povezanih direktiv. Celotno besedilo EU-izjave o skladnosti je na voljo na spletnem mestu: [www.asus.com/support](http://www.asus.com/support)

**Español** Por la presente, ASUSTEK Computer Inc. declara que este dispositivo cumple los requisitos básicos y otras disposiciones pertinentes de las directivas relacionadas. El texto completo de la declaración de la UE de conformidad está disponible en: [www.asus.com/support](http://www.asus.com/support)

**Svenska** ASUSTeK Computer Inc. förklarar härmed att denna enhet överensstämmer med de grundläggande kraven och andra relevanta föreskrifter i relaterade direktiv. Fulltext av EU-försäkran om överensstämmelse finns på: [www.asus.com/support](http://www.asus.com/support)

**Українська** ASUSTeK Computer Inc. заявляє, що цей пристрій відповідає основним вимогам та іншим відповідним положенням відповідних Директив. Повний текст декларації відповідності стандартам ЄС доступний на: [www.asus.com/support](http://www.asus.com/support)

**Türkçe** ASUSTeK Computer Inc., bu aygıtın temel gereksinimlerle ve ilişkili Yönergelerin diğer ilgili kullarıyla uyumlu olduğunu beyan eder. AB uyuşluk bildirimini tam metni şu adreste bulunabilir: [www.asus.com/support](http://www.asus.com/support)

**Bosanski** ASUSTeK Computer Inc. ovim izjavljuje da je ovaj uređaj uskladen sa bitnim zahtjevima i ostalim odgovarajućim odredbama vezanih direktiva. Cijeli tekst EU izjave o uskladenosti dostupan je na: [www.asus.com/support](http://www.asus.com/support)

## ASUS contact information

### ASUSTeK COMPUTER INC.

Address 4F, No. 150, Li-Te Road, Peitou, Taipei 112, Taiwan  
Telephone +886-2-2894-3447  
Fax +886-2-2890-7798  
Web site [www.asus.com](http://www.asus.com)

#### **Technical Support**

Telephone +86-21-38429911  
Fax +86-21-5866-8722, ext. 9101#  
Online support <http://qr.asus.com/techserv>

### ASUS COMPUTER INTERNATIONAL (America)

Address 800 Corporate Way, Fremont, CA 94539, USA  
Telephone +1-510-739-3777  
Fax +1-510-608-4555  
Web site <http://www.asus.com/us/>

#### **Technical Support**

Support fax +1-812-284-0883  
Telephone +1-812-282-2787  
Online support <http://qr.asus.com/techserv>

### ASUS COMPUTER GmbH (Germany and Austria)

Address Harkort Str. 21-23, 40880 Ratingen, Germany  
Fax +49-2102-959931  
Web site <http://www.asus.com/de>  
Online contact <http://eu-rma.asus.com/sales>

#### **Technical Support**

Telephone +49-2102-5789555  
Support Fax +49-2102-959911  
Online support <http://qr.asus.com/techserv>

**DECLARATION OF CONFORMITY**

Per FCC Part 2 Section 2. 1077(a)

**Responsible Party Name: Asus Computer International****Address: 800 Corporate Way, Fremont, CA 94539.****Phone/Fax No: (510)739-3777/(510)608-4555**

hereby declares that the product

**Product Name : Motherboard****Model Number : ROG MAXIMUS X APEX**

Conforms to the following specifications:

 FCC Part 15, Subpart B, Unintentional Radiators**Supplementary Information:**

This device complies with part 15 of the FCC Rules. Operation is subject to the following two conditions: (1) This device may not cause harmful interference, and (2) this device must accept any interference received, including interference that may cause undesired operation.

Representative Person's Name : Steve Chang / President

A handwritten signature in blue ink that reads "Steve Chang".

Signature :

Date : Sep. 09, 2016

Ver. 170324