

Wireless Noise Canceling Stereo Headset
WH-1000XM3



Use this manual if you encounter any problems, or have any questions.

The main update contents of the headset software version 2.0.0 and later are supported.

Update the software of the headset and “Sony | Headphones Connect” app to the latest version. For details, refer to the following:

<https://www.sony.net/elesupport/>

Getting started

[What you can do with the Bluetooth function](#)

[About voice guidance](#)

Supplied accessories

[Checking the package contents](#)

[Setting the headset in the carrying case](#)

Parts and controls

[Location and function of parts](#)

[About the indicator](#)

Power/Charging

[Charging the headset](#)

- [Available operating time](#)
- [Checking the remaining battery charge](#)
- [System requirements for battery charge using USB](#)
- [Turning on the headset](#)
- [Turning off the headset](#)

Making connections

[How to make a wireless connection to Bluetooth devices](#)

Easy setup with app

- [Connecting with the "Sony | Headphones Connect" app](#)

Android smartphone

- [Pairing and connecting with an Android smartphone](#)
- [Connecting to a paired Android smartphone](#)
- [One-touch connection \(NFC\) with an Android smartphone \(Android 4.1 or later\)](#)
- [Disconnecting the Android smartphone with one-touch \(NFC\)](#)
- [Switching the device by one touch \(NFC\)](#)

iPhone (iOS devices)

- [Pairing and connecting with an iPhone](#)
- [Connecting to a paired iPhone](#)

Computers

- [Pairing and connecting with a computer \(Windows 10\)](#)
- [Pairing and connecting with a computer \(Windows 8/Windows 8.1\)](#)
- [Pairing and connecting with a computer \(Windows 7\)](#)
- [Pairing and connecting with a computer \(Mac\)](#)
- [Connecting to a paired computer \(Windows 10\)](#)
- [Connecting to a paired computer \(Windows 8/Windows 8.1\)](#)
- [Connecting to a paired computer \(Windows 7\)](#)
- [Connecting to a paired computer \(Mac\)](#)

Other Bluetooth devices

- [Pairing and connecting with other Bluetooth devices](#)
- [Connecting to a paired Bluetooth device](#)

Multipoint connection

- [Connecting the headset to both a music player and a smartphone or mobile phone](#)
- [Connecting the headset to 2 Android smartphones](#)
- [Connecting the headset to an Android smartphone and an iPhone](#)

[Disconnecting Bluetooth connection \(after use\)](#)

[Using the supplied headphone cable](#)

Listening to music

Listening to music via a Bluetooth connection

- [Listening to music from a device via Bluetooth connection](#)
- [Controlling the audio device \(Bluetooth connection\)](#)
- [Disconnecting Bluetooth connection \(after use\)](#)

Noise canceling function

- [What is noise canceling?](#)
- [Using the noise canceling function](#)
- [Optimizing the noise canceling function to suit the wearer \(NC Optimizer\)](#)

Listening to ambient sound

- [Listening to ambient sound during music playback \(Ambient Sound Mode\)](#)
- [Listening to ambient sound quickly \(Quick Attention Mode\)](#)

Sound quality mode

- [About the sound quality mode](#)

[Supported codecs](#)

[About the DSEE HX function](#)

Making phone calls

[Receiving a call](#)

[Making a call](#)

[Functions for a phone call](#)

[Disconnecting Bluetooth connection \(after use\)](#)

Using the voice assist function

[Using the Google Assistant](#)

[Using the voice assist function \(Google app\)](#)

[Using the voice assist function \(Siri\)](#)

Using the apps

[What you can do with "Sony | Headphones Connect" app](#)

[Installing "Sony | Headphones Connect" app](#)

Important information

[Precautions](#)

[Trademarks](#)

[Customer support websites](#)

Troubleshooting

[What can I do to solve a problem?](#)

Power/Charging

- [The headset is not turned on.](#)

- [Charging cannot be done.](#)

- [Charging time is too long.](#)

- [The headset cannot be recognized by a computer.](#)

- [The remaining battery charge of the headset is not displayed on the screen of an iPhone or iPod touch.](#)

Sound

- [No sound](#)

- [Low sound level](#)

- [Low sound quality](#)

- [Sound skips frequently.](#)

- [The noise canceling effect is not sufficient.](#)

Bluetooth

- [Pairing cannot be done.](#)

- [One-touch connection \(NFC\) does not work.](#)

- [Unable to make a Bluetooth connection.](#)

- [Distorted sound](#)

- [The Bluetooth wireless communication range is short, or the sound skips.](#)

- [The headset does not operate properly.](#)

- [Cannot hear a person on a call.](#)

- [Low voice from callers](#)

Resetting or initializing the headset

- [Resetting the headset](#)

- [Initializing the headset to restore factory settings](#)

Wireless Noise Canceling Stereo Headset
WH-1000XM3

What you can do with the Bluetooth function

The headset uses BLUETOOTH® wireless technology, allowing you to listen to music or make phone calls wirelessly.

Listening to music

You can receive audio signals from a smartphone or music player to enjoy music wirelessly.



Talking on the phone

You can make and receive a call hands-free, while leaving your smartphone or mobile phone in your bag or pocket.



Wireless Noise Canceling Stereo Headset
WH-1000XM3

About voice guidance

You will hear voice guidance in the following situations via the headset.

- When powering on: "Power on"
- When powering off: "Power off"
- When entering pairing mode: "Bluetooth pairing"
- When establishing a Bluetooth connection: "Bluetooth connected"
- When disconnecting a Bluetooth connection: "Bluetooth disconnected"
- When checking the remaining battery charge: "Battery about XX %" (The "XX" value indicates the approximate remaining charge. Use it as a rough estimate.) / "Battery fully charged"
- When the remaining battery charge is low: "Low battery, please recharge headset"
- When automatically turning off due to low battery: "Please recharge headset. Power off"
- When turning on the noise canceling function: "Noise canceling"
- When turning on the Ambient Sound Mode: "Ambient sound"
- When turning off the noise canceling function and the Ambient Sound Mode: "Ambient Sound Control off"
- When starting the NC Optimizer: "Optimizer start"
- When the NC Optimizer is finished: "Optimizer finished"
- When the Google Assistant is not available on the smartphone connected to the headset even if you press the Google Assistant button on the headset: "The Google Assistant is not connected"

Wireless Noise Canceling Stereo Headset
WH-1000XM3

Checking the package contents

After opening the package, check that all of the items in the list are included. If any items are missing, contact your dealer.

Numbers in () indicate the item amount.

Wireless Noise Canceling Stereo Headset
USB Type-C™ cable (USB-A to USB-C™) (approx. 20 cm (7 7/8 in.))(1)



Headphone cable (approx. 1.2 m (47 1/4 in.)) (1)

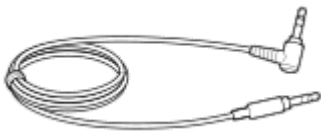

Carrying case (1)

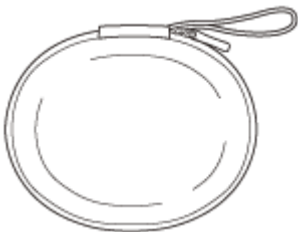

Plug adapter for in-flight use (1)

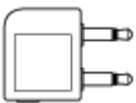

Wireless Noise Canceling Stereo Headset
WH-1000XM3

Setting the headset in the carrying case

When finished using the headset, fold it and put it in the supplied carrying case as shown in the figure below.



To store the cables and plug adaptor for in-flight use

Put the cables and the plug adaptor for in-flight use in the holder in the carrying case as shown below.

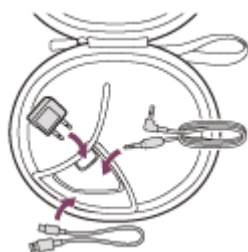

Location and function of parts

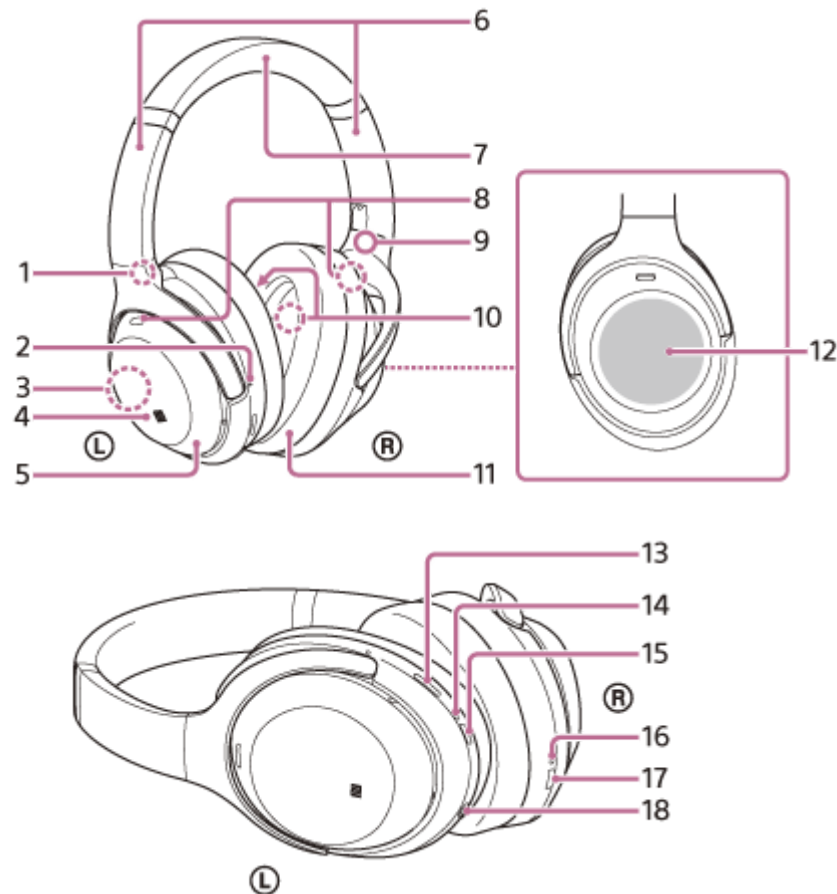

1. L mark
2. Tactile dot
The left unit has a tactile dot.
3. Built-in antenna
A Bluetooth antenna is built into the headset.
4. N-Mark
5. Ⓛ left unit
6. Slider
Slide to adjust the length of the headband.
7. Headband
8. Microphone (external) for the noise canceling function
Picks up the sound of the noise when the noise canceling function is in use.
9. R mark
10. Microphone (internal) for the noise canceling function
Picks up the sound of the noise when the noise canceling function is in use.
11. Ⓜ right unit
12. Touch sensor control panel
Remotely controls music playback of the connected Bluetooth device or performs other operations using touch operation.
13. NC/AMBIENT (noise canceling/Ambient Sound Mode) button
Press and hold (about 2 seconds) to optimize the noise canceling function (NC Optimizer).
14. Indicator (blue/red)
Lights up in red or blue to indicate the power or communication status of the headset.
15. ⏻ (power) button

16. Indicator (red)

Lights up in red during charging.

17. USB Type-C port

Connect the headset to a computer or a USB AC adapter (sold separately) with the supplied USB Type-C cable to charge the headset.

18. INPUT jack

Connect a music player, etc. using the supplied headphone cable. Make sure that you insert the cable until it clicks. If the plug is not connected correctly, you may not hear the sound normally.

Related Topic

- [About the indicator](#)
- [Checking the remaining battery charge](#)

Wireless Noise Canceling Stereo Headset
WH-1000XM3

About the indicator

You can check various statuses of the headset by the indicators.

● : Turns on in blue / ● : Turns on in red / - : Turns off

Indicator (blue/red) next to the button



Turning on

● - ● (flashes 2 times)

Turning off

 (lights up for about 2 seconds)

Displaying the remaining battery charge

- Remaining charge: High
● - ● (flashes 2 times)
- Remaining charge: Low (requires charging)
 -  -  (flashes for about 15 seconds)

For details, refer to “[Checking the remaining battery charge](#)”.

When the remaining battery charge is low



 -  -  (flashes for about 15 seconds)

Bluetooth function

- Device registration (pairing) mode
● ● -- ● ● -- (flashes 2 times each)
- Not connected
● -- ● -- ● -- ● -- (about a 1-second interval)
- Connection process completed
● ● ● ● ● ● ● ● (flashes quickly for about 5 seconds)
- Connected
● ----- ● ----- (about a 5-second interval)
- Incoming call
● ● ● ● ● ● ● ● ●

The not connected and connected status indicators automatically turn off after a period of time has passed. They start flashing again for a period of time when some operation is performed. When the remaining battery charge becomes low, the indicator changes to a red flashing indicator.

Other

- Headphone cable connected (power is turned on)
● ----- ● ----- (about a 5-second interval)
When the remaining battery charge becomes low, it changes to a red flashing indicator.
- Updating software
 --  --

- Initialization completed



For details, refer to “[Initializing the headset to restore factory settings](#)”.

USB Type-C port indicator (red)

Charging

- While charging



Turns off after the charging is complete.

- Abnormal temperature

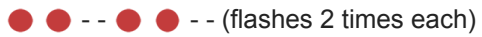

- Abnormal charging



Wireless Noise Canceling Stereo Headset
WH-1000XM3

Charging the headset

The headset contains a built-in lithium-ion rechargeable battery. Use the supplied USB Type-C cable to charge the headset before use.

1 Connect the headset and an AC outlet.

Use the USB Type-C cable (supplied) and a USB AC adapter (sold separately) to connect the headset to an AC outlet.

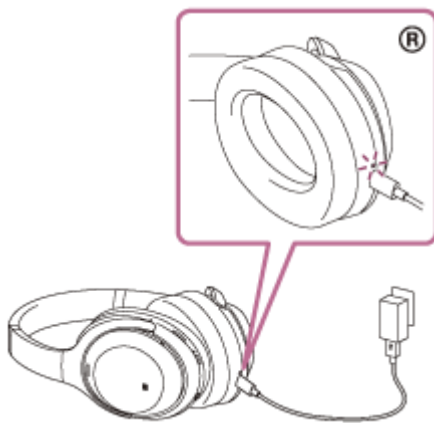

- The indicator (red) of the headset lights up.
- Charging is completed in about 3 hours (*) and the indicator (red) goes off automatically.

* Time required for charging the empty battery to its full capacity. The charging time may differ depending on the conditions of use.

After charging is complete, disconnect the USB Type-C cable.

Hint

- You can also use the supplied USB Type-C cable to connect to a running computer to charge the headset.
- If charging starts while the headset is turned on, the headset will turn off automatically.

Note

- Charging may not be successful with cables other than the supplied USB Type-C cable.
- Charging may not be successful or require more charging time depending on the type of USB AC adapter.
- When the headset is connected to an AC outlet or computer, all operations such as turning on the headset, registering or connecting to Bluetooth devices, and music playback cannot be performed.
- The headset cannot be charged when the computer is in standby (sleep) or hibernation mode. In this case, change the computer settings to charge the headset once again.
- If the headset is not used for a long time, the rechargeable battery usage hours may be reduced. However, the battery life will improve after a few recharges.
- If you store the headset for a long time, charge the battery to its full capacity once every 6 months to avoid over-discharge.
- If the headset is not used for a long time, it may take longer to charge the battery.
- If the headset detects a problem while charging due to the following causes, the indicator (red) may turn off even if the charging is not complete. In this case, charge once again within the charging temperature range. If the problem persists, consult with your

Sony dealer.

- Ambient temperature exceeds the charging temperature range of 5 °C – 35 °C (41 °F - 95 °F).
- There is a problem with the battery.

- If the headset is not used for a long time, the indicator (red) may not light up when charging. Please wait a moment until the indicator (red) lights up.

- If the usage hours of the built-in rechargeable battery decreases significantly, the battery should be replaced. Consult with your nearest Sony dealer to replace the rechargeable battery.

- Avoid exposure to extreme temperature changes, direct sunlight, moisture, sand, dust, and electrical shock. Never leave the headset in a parked vehicle.

- When connecting to a computer, use only the supplied USB Type-C cable, and be sure to directly connect them. Charging will not be properly completed through an indirect connection such as a USB hub.

4-740-049-11(2) Copyright 2018 Sony Corporation

Available operating time

The available operating times of the headset on a fully-charged battery are as follows:

Bluetooth connection

Music Playback time

Codec	DSEE HX	Noise canceling function/Ambient Sound Mode	Available operating time
Qualcomm® aptX™ audio/aptX HD/LDAC™	AUTO/OFF	Noise canceling function: ON	Max. 24 hours
		Ambient Sound Mode: ON	Max. 18 hours
		OFF	Max. 30 hours
AAC	AUTO	Noise canceling function: ON	Max. 24 hours
		Ambient Sound Mode: ON	Max. 18 hours
		OFF	Max. 30 hours
	OFF	Noise canceling function: ON	Max. 30 hours
		Ambient Sound Mode: ON	Max. 22 hours
		OFF	Max. 38 hours
SBC	AUTO	Noise canceling function: ON	Max. 22 hours
		Ambient Sound Mode: ON	Max. 16 hours
		OFF	Max. 28 hours
	OFF	Noise canceling function: ON	Max. 28 hours
		Ambient Sound Mode: ON	Max. 20 hours
		OFF	Max. 36 hours

- Music can be played for about 5 hours after 10 minutes of charging (when charged with a USB AC adapter that supplies a current of 1.5 A or more).

Communication time

Noise canceling function/Ambient Sound Mode	Available operating time
Noise canceling function: ON	Max. 24 hours
Ambient Sound Mode: ON	Max. 18 hours
OFF	Max. 30 hours

Standby time

Noise canceling function/Ambient Sound Mode	Available operating time
Noise canceling function: ON	Max. 30 hours
Ambient Sound Mode: ON	Max. 22 hours
OFF	Max. 200 hours

Headphone cable connected (power is turned on)

Noise canceling function/Ambient Sound Mode	Available operating time
Noise canceling function: ON	Max. 36 hours
Ambient Sound Mode: ON	Max. 26 hours
OFF	Max. 44 hours

Hint

- By using the "Sony | Headphones Connect" app, you can check which codec is used for a connection or switch the DSEE HX function.

Note

- Usage hours may be different depending on the settings and conditions of use.

Related Topic

- [Supported codecs](#)
- [About the DSEE HX function](#)
- [What you can do with "Sony | Headphones Connect" app](#)

Checking the remaining battery charge

You can check the remaining battery charge of the rechargeable battery.

When the  button is pressed while the headset power is on, the voice guidance indicating the remaining battery charge can be heard.

“Battery about XX %” (The “XX” value indicates the approximate remaining charge.)

“Battery fully charged”

The remaining battery charge indicated by the voice guidance may differ from the actual remaining charge in some cases. Please use it as a rough estimate.

In addition, the red indicator flashes (about 15 seconds) if the remaining battery charge is low when the headset is turned on.

When the remaining charge is low

The currently operating indicator display changes to red. If you hear the voice guidance say, “Low battery, please recharge headset”, charge the headset as soon as possible.

When the battery becomes completely empty, the headset sounds a warning beep, the voice guidance says, “Please recharge headset. Power off”, and the headset automatically turns off.

When you are using an iPhone or iPod touch

When the headset is connected to an iPhone or iPod touch (iOS) that supports HFP (Hands-free Profile), it will show an icon that indicates the remaining battery charge of the headset on the screen.

Usable devices

iPhone or iPod touch which supports HFP (Hands-free Profile)(iOS 5.0 or later)

iOS 10.2 or later

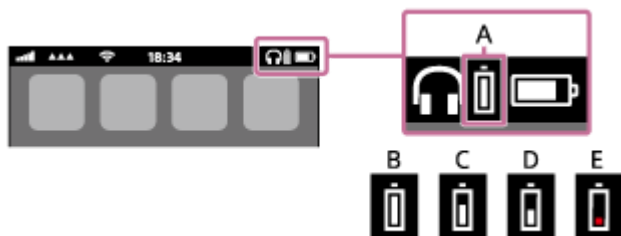

iOS 7.0 or later

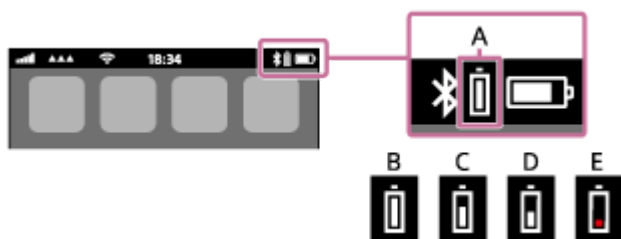

iOS 5.X / 6.X

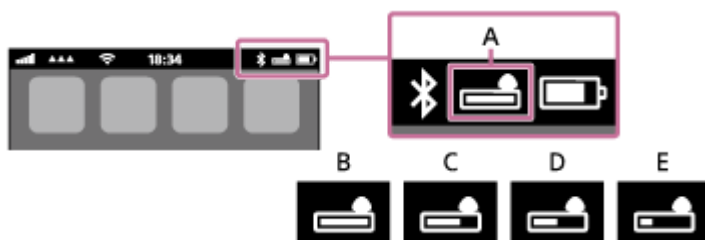

A: Remaining battery charge of the headset

The approximate remaining charge is shown at 10 different levels. B through E are display examples.

B: 100%

C: 70%

D: 50%

E: 20% or lower (needs to charge)

The remaining battery charge of the headset is also displayed on the widget of an iPhone or iPod touch running iOS 9 or later.

Furthermore, the remaining charge which is displayed may differ from the actual remaining charge in some cases. Please use it as a rough estimate.

Hint

- You can also check the remaining battery charge with the "Sony | Headphones Connect" app. Android smartphones and the iPhone/iPod touch both support this app.

Note

- If you connect the headset to an iPhone or iPod touch with "Media audio" (A2DP) only in a multipoint connection, the remaining battery charge will not be displayed correctly.
- The remaining battery charge may not be properly displayed immediately after a software update or if the headset has not been used for a long time. In this case, repeatedly charge and discharge the battery multiple times to properly display the remaining battery charge.

Related Topic

- [What you can do with "Sony | Headphones Connect" app](#)

Wireless Noise Canceling Stereo Headset
WH-1000XM3

System requirements for battery charge using USB

USB AC adaptor

A commercially available USB AC adapter capable of supplying an output current of 1.5 A or more (If the output current is less than 1.5 A, the charging time will increase, and the music playback time after 10 minutes of charging will decrease.)

Personal Computer

(As of August 2018)

Computers on which the following OS is installed and a USB terminal is equipped as a standard

- It is not that we guarantee operation on all computers which meet the following environment.
- Operations using a custom-built or homebuilt computer are not guaranteed.

(when using Windows®)

Windows® 10 Home / Windows® 10 Pro

Windows® 8.1 / Windows® 8.1 Pro

Windows® 8 / Windows® 8 Pro

Windows® 7 Home Basic / Home Premium / Professional / Ultimate

(when using Mac)

macOS (version 10.10 or later)

Design and specifications are subject to change without notice.

Wireless Noise Canceling Stereo Headset
WH-1000XM3

Turning on the headset

- 1 Press and hold the  button for about 2 seconds until the indicator (blue) flashes.



Related Topic

- [Turning off the headset](#)

Wireless Noise Canceling Stereo Headset
WH-1000XM3

Turning off the headset

- 1 Press and hold the  button for about 2 seconds until the indicator (blue) turns off.



Related Topic

- [Turning on the headset](#)

How to make a wireless connection to Bluetooth devices

You can enjoy music and hands-free calling with the headset wirelessly by using your device's Bluetooth function.

Device registration (pairing)

To use the Bluetooth function, both of the connecting devices must be registered in advance. The operation to register a device is called device registration (pairing).

If the device to be connected does not support the one-touch connection (NFC), operate the headset and the device to perform device registration (pairing).

If the device supports one-touch connection (NFC), you can just touch to perform device registration (pairing) and establish a Bluetooth connection.

Connecting the headset to a registered (paired) device

Once a device is registered (paired), it is not necessary to register it again. Connect to a device that is already registered (paired) with the headset using the appropriate method.

Wireless Noise Canceling Stereo Headset
WH-1000XM3

Connecting with the "Sony | Headphones Connect" app

Launch the "Sony | Headphones Connect" app on your Android™ smartphone/iPhone to connect the headset to a smartphone or iPhone. For more details, refer to the "Sony | Headphones Connect" app help guide.

http://rd1.sony.net/help/mdr/hpc/h_zz/



Sony Headphones Connect 

Note

- The connection with some smartphones and iPhones may become unstable when connecting using the "Sony | Headphones Connect" app. In that case, follow the procedures in "[Connecting to a paired Android smartphone](#)," or "[Connecting to a paired iPhone](#)" to connect to the headset.

Related Topic

- [Connecting to a paired Android smartphone](#)
- [Connecting to a paired iPhone](#)
- [What you can do with "Sony | Headphones Connect" app](#)
- [Installing "Sony | Headphones Connect" app](#)

Wireless Noise Canceling Stereo Headset
WH-1000XM3

Pairing and connecting with an Android smartphone

The operation to register the device that you wish to connect to is called pairing. First, pair a device to use it with the headset for the first time.

Before you start the pairing operation, make sure that:

- The Android smartphone is placed within 1 m (3 feet) of the headset.
- The headset is charged sufficiently.
- The operating instructions of the smartphone is in hand.

1 Enter pairing mode on this headset.

Turn on the headset when you pair the headset with a device for the first time after you bought it or after you initialized the headset (the headset has no pairing information). The headset enters pairing mode automatically. When you pair a 2nd or subsequent device (the headset has pairing information for other devices), press and hold the  button for about 7 seconds.

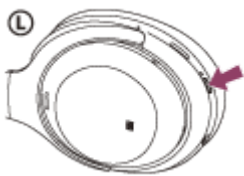

Check that the blue indicator repeatedly flashes 2 times in a row. You will hear a voice guidance "Bluetooth pairing".

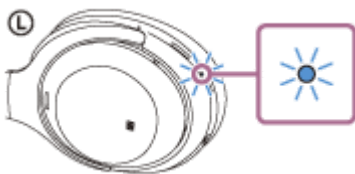

2 Unlock the screen of the Android smartphone if it is locked.

3 Search for the headset on the Android smartphone.

1. Select [Settings] - [Wireless & networks] - [Bluetooth].



2. Touch [] next to [Bluetooth] to turn on the Bluetooth function.

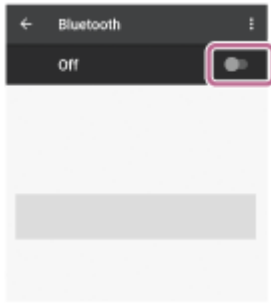

4 Touch [WH-1000XM3].

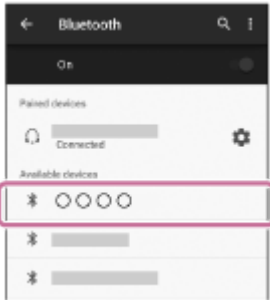

If passkey (*) input is required on the display of the smartphone, input “0000.”

The headset and smartphone are paired and connected with each other. You will hear a voice guidance “Bluetooth connected”.

If they are not connected, see [“Connecting to a paired Android smartphone”](#).

If [WH-1000XM3] does not appear on the Android smartphone screen, try again from step 3.

* A Passkey may be called “Passcode,” “PIN code,” or “Password.”

Hint

- The above procedure is an example. For more details, refer to the operating instructions supplied with your Android smartphone.
- To delete all pairing information, see [“Initializing the headset to restore factory settings”](#).

Note

- When registering a device (pairing), either [WH-1000XM3] or [LE_WH-1000XM3] or both are displayed on the connecting device. If both or [WH-1000XM3] are displayed touch [WH-1000XM3], or touch [LE_WH-1000XM3] if [LE_WH-1000XM3] is displayed.
- If pairing is not established within 5 minutes, the pairing mode is canceled, and the headset turns off. In this case, start the operation over from step 1.
- Once Bluetooth devices are paired, there is no need to pair them again, except in the following cases:
 - Pairing information has been deleted after repair, etc.
 - When a 9th device is paired
The headset can be paired with up to 8 devices. If a new device is paired after 8 devices are already paired, the registration information of the paired device with the oldest connection date is overwritten with the information for the new device.
 - When the pairing information for the headset has been deleted from the Bluetooth device.
 - When the headset is initialized
All of the pairing information is deleted. In this case, delete the pairing information for the headset from the Bluetooth device and then pair them again.
- The headset can be paired with multiple devices, but can only play music from one paired device at a time.

Related Topic

- [How to make a wireless connection to Bluetooth devices](#)
- [Connecting to a paired Android smartphone](#)

- Listening to music from a device via Bluetooth connection
- Initializing the headset to restore factory settings

4-740-049-11(2) Copyright 2018 Sony Corporation

Connecting to a paired Android smartphone

1 Unlock the screen of the Android smartphone if it is locked.

2 Turn on the headset.

Press and hold the  button for about 2 seconds.

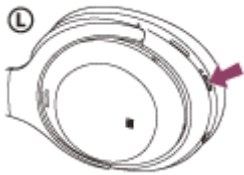

Check that the indicator continues to flash blue after you release your finger from the button. You will hear a voice guidance "Power on".

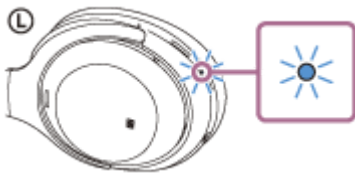

After the headset turns on, if it has automatically connected to the last connected device, you will hear a voice guidance "Bluetooth connected".

Check the connection status on the Android smartphone. If it is not connected, proceed to step 3.

3 Display the devices paired with the Android smartphone.

1. Select [Settings] - [Wireless & networks] - [Bluetooth].



2. Touch [] next to [Bluetooth] to turn on the Bluetooth function.

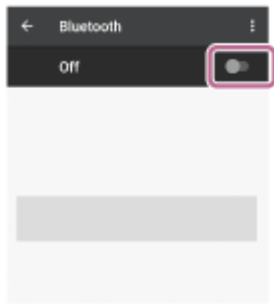

4 Touch [WH-1000XM3].

You will hear a voice guidance “Bluetooth connected”.

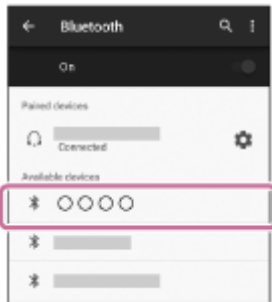

Hint

- The above procedure is an example. For more details, refer to the operating instructions supplied with your Android smartphone.
- If the smartphone was connected with the headset the last time, an HFP/HSP connection is established when you turn on the headset. Double-tap (gently touch it with your finger and immediately release it 2 times in rapid succession (interval of about 0.4 seconds)) the touch sensor control panel (middle of the right unit) while the headset power is turned on to switch to a music playback connection (A2DP).

Note

- When connecting, either [WH-1000XM3] or [LE_WH-1000XM3] or both are displayed on the connecting device. If both or [WH-1000XM3] are displayed touch [WH-1000XM3], or touch [LE_WH-1000XM3] if [LE_WH-1000XM3] is displayed.
- If the last-connected Bluetooth device is placed near the headset, the headset may connect automatically to the device by simply turning on the headset. In that case, deactivate the Bluetooth function on the device or turn off the power.
- If you cannot connect your smartphone to the headset, delete the headset pairing information on your smartphone and perform the pairing again. As for the operations on your smartphone, refer to the operating instructions supplied with your smartphone.

Related Topic

- [How to make a wireless connection to Bluetooth devices](#)
- [Pairing and connecting with an Android smartphone](#)
- [Listening to music from a device via Bluetooth connection](#)

Wireless Noise Canceling Stereo Headset
WH-1000XM3

One-touch connection (NFC) with an Android smartphone (Android 4.1 or later)

By touching the headset with a smartphone, the headset turns on automatically and then pairs and makes a Bluetooth connection.

Compatible smartphones

NFC -compatible smartphones installed with Android 4.1 or later.

NFC

NFC (Near Field Communication) is a technology enabling short-range wireless communication between various devices, such as smartphones and IC tags. Thanks to the NFC function, data communication — for example, Bluetooth pairing — can be achieved easily by simply touching NFC -compatible devices together (i.e., at the N -Mark symbol or location designated on each device).

- 1 **Unlock the screen of the smartphone if it is locked.**
- 2 **Turn on the smartphone's NFC function.**
 1. Select [Settings] - [Wireless & networks] - [More].
 2. Touch [] next to [NFC] to turn on the NFC function.



- 3 **Touch the headset with the smartphone.**

- Touch the smartphone on the N-Mark of the headset. Keep touching the headset with the smartphone until the smartphone reacts.
- Refer to the operating instructions of the smartphone for the designated location to be touched on the smartphone.

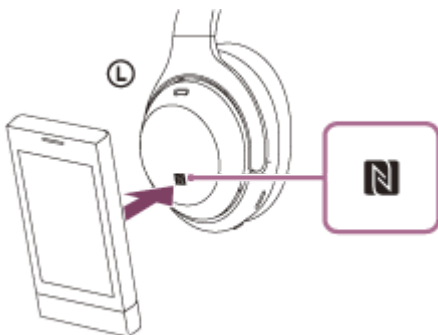

Follow the on-screen instructions to complete the pairing and connection.

When the headset is connected with the smartphone, the indicator (blue) starts flashing slowly. You will hear a voice guidance "Bluetooth connected".

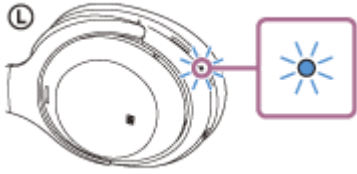

- To disconnect, touch the smartphone again.
- To connect a paired smartphone, perform step 3.
- Unlock the screen of the smartphone if it is locked.

Hint

- The above procedure is an example. For more details, refer to the operating instructions supplied with your Android smartphone.
- If you cannot connect the headset, try the following.
 - Unlock the screen of the smartphone if it is locked, and move the smartphone slowly over the N-Mark.
 - If the smartphone is in a case, remove the case.
 - Check that the Bluetooth function of the smartphone is enabled.
- If you touch an NFC-compatible smartphone with the headset, the smartphone terminates Bluetooth connection with any current device, and connects to the headset (One-touch connection switching).

Related Topic

- [How to make a wireless connection to Bluetooth devices](#)
- [Disconnecting the Android smartphone with one-touch \(NFC\)](#)
- [Switching the device by one touch \(NFC\)](#)
- [Listening to music from a device via Bluetooth connection](#)

Wireless Noise Canceling Stereo Headset
WH-1000XM3

Disconnecting the Android smartphone with one-touch (NFC)

You can disconnect the headset from the connected smartphone by touching the headset with it.

1 Unlock the screen of the smartphone if it is locked.

2 Touch the headset with the smartphone.

Touch the smartphone to the N-Mark on the headset. You will hear a voice guidance "Bluetooth disconnected".

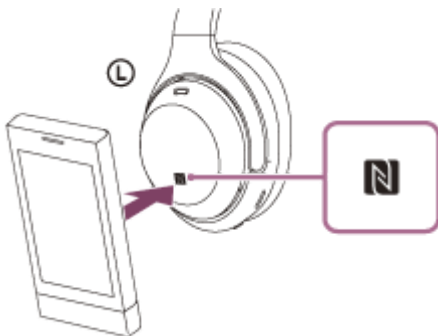

Note

- Under the settings at the time of purchase, if no operations are performed for about 5 minutes after disconnecting, the headset automatically turns off. Press and hold the  button for about 2 seconds to turn off the power before that time. You will hear a voice guidance "Power off", the blue indicator turns off, and the headset powers off. The time when the power turns off can be changed in the "Sony | Headphones Connect" app. For more details, refer to the "Sony | Headphones Connect" app help guide.
http://rd1.sony.net/help/mdr/hpc/h_zy/

Wireless Noise Canceling Stereo Headset
WH-1000XM3

Switching the device by one touch (NFC)

- If you touch an NFC-compatible smartphone to the headset while it is connected to another Bluetooth device, it can switch the connection to the smartphone (One-touch connection switching). However, the connection cannot be switched when talking on a headset connected to a Bluetooth compatible mobile phone.
- When an NFC-compatible smartphone that is connected to the headset is touched by another NFC-compatible Bluetooth headset or Bluetooth speaker, the headset is disconnected and the smartphone connects to the Bluetooth device that touched it.

Note

- Unlock the smartphone screen in advance if it is locked.

Wireless Noise Canceling Stereo Headset
WH-1000XM3

Pairing and connecting with an iPhone

The operation to register the device that you wish to connect to is called pairing. First, pair a device to use it with the headset for the first time.

Before you start the pairing operation, make sure that:

- The iPhone is placed within 1 m (3 feet) of the headset.
- The headset is charged sufficiently.
- The operating instructions of the iPhone is in hand.

1 Enter pairing mode on this headset.

Turn on the headset when you pair the headset with a device for the first time after you bought it or after you initialized the headset (the headset has no pairing information). The headset enters pairing mode automatically. When you pair a 2nd or subsequent device (the headset has pairing information for other devices), press and hold the  button for about 7 seconds.



Check that the blue indicator repeatedly flashes 2 times in a row. You will hear a voice guidance "Bluetooth pairing".

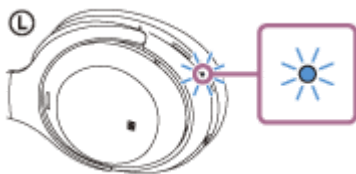

2 Unlock the screen of the iPhone if it is locked.

3 Select the Bluetooth setting on the iPhone.

1. Select [Settings].
2. Touch [Bluetooth].



3. Touch [] to change it to [] (turn on the Bluetooth function).

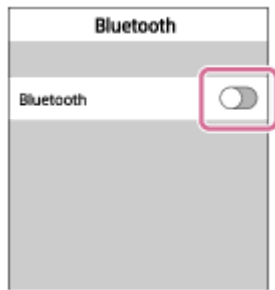

4 Touch [WH-1000XM3].



If passkey (*) input is required on the display of the iPhone, input “0000.”

The headset and iPhone are paired and connected with each other. You will hear a voice guidance “Bluetooth connected”.

If they are not connected, see [“Connecting to a paired iPhone”](#).

If [WH-1000XM3] does not appear on the display, try again from step 3.

* A Passkey may be called “Passcode,” “PIN code,” or “Password.”

Hint

- The above procedure is an example. For more details, refer to the operating instructions supplied with your iPhone.
- To delete all Bluetooth pairing information, see [“Initializing the headset to restore factory settings”](#).

Note

- When registering a device (pairing), either [WH-1000XM3] or [LE_WH-1000XM3] or both are displayed on the connecting device. If both or [WH-1000XM3] are displayed touch [WH-1000XM3], or touch [LE_WH-1000XM3] if [LE_WH-1000XM3] is displayed.
- If pairing is not established within 5 minutes, pairing mode is canceled, and the headset turns off. In this case, start the operation over from step 1.
- Once Bluetooth devices are paired, there is no need to pair them again, except in the following cases:
 - Pairing information has been deleted after repair, etc.
 - When a 9th device is paired.
The headset can be paired with up to 8 devices. If a new device is paired after 8 devices are already paired, the registration information of the paired device with the oldest connection date is overwritten with the information for the new device.
 - When the pairing information for the headset has been deleted from the Bluetooth device.
 - When the headset is initialized.
All of the pairing information is deleted. In this case, delete the pairing information for the headset from the device and then pair them again.
- The headset can be paired with multiple devices, but can only play music from one paired device at a time.

Related Topic

- [How to make a wireless connection to Bluetooth devices](#)
- [Connecting to a paired iPhone](#)

- Listening to music from a device via Bluetooth connection
- Initializing the headset to restore factory settings

4-740-049-11(2) Copyright 2018 Sony Corporation

Connecting to a paired iPhone

1 Unlock the screen of the iPhone if it is locked.

2 Turn on the headset.

Press and hold the  button for about 2 seconds.



Check that the blue indicator continues to flash after you release your finger from the button. You hear the voice guidance “Power on”.

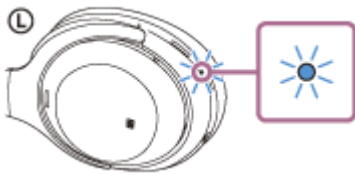

After the headset turns on, if it has automatically connected to the last connected device, you will hear a voice guidance “Bluetooth connected”.

Check the connection status on the iPhone. If it is not connected, proceed to step 3.

3 Display the devices paired with the iPhone.

1. Select [Settings].
2. Touch [Bluetooth].

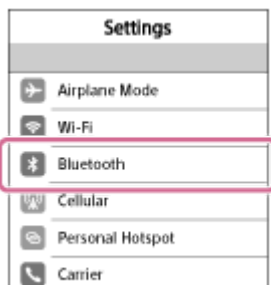

3. Touch [] to change it to [] (turn on the Bluetooth function).

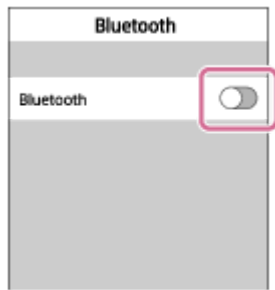

4 Touch [WH-1000XM3].

You will hear a voice guidance “Bluetooth connected”.



Hint

- The above procedure is an example. For more details, refer to the operating instructions supplied with your iPhone.
- If the iPhone was connected with the headset the last time, an HFP/HSP connection is established when you turn on the headset. Double tap (gently touch it with your finger and immediately release it two times in rapid succession (interval of about 0.4 seconds)) the touch sensor control panel (middle of the right unit) while the headset power is turned on to switch to a music playback connection (A2DP).

Note

- When connecting, either [WH-1000XM3] or [LE_WH-1000XM3] or both are displayed on the connecting device. If both or [WH-1000XM3] are displayed touch [WH-1000XM3], or touch [LE_WH-1000XM3] if [LE_WH-1000XM3] is displayed.
- If the last-connected Bluetooth device is placed near the headset, the headset may connect automatically to the device by simply turning on the headset. In that case, deactivate the Bluetooth function on the device or turn off the power.
- If you cannot connect your iPhone to the headset, delete the headset pairing information on your iPhone and perform the pairing again. As for the operations on your iPhone, refer to the operating instructions supplied with your iPhone.

Related Topic

- [How to make a wireless connection to Bluetooth devices](#)
- [Pairing and connecting with an iPhone](#)
- [Listening to music from a device via Bluetooth connection](#)

Pairing and connecting with a computer (Windows 10)

The operation to register the device that you wish to connect to is called pairing. First, pair a device to use it with the headset for the first time.

Before you start the pairing operation, make sure that:

- Your computer has a Bluetooth function that supports music playback connections (A2DP).
- The computer is placed within 1 m (3 feet) of the headset.
- The headset is charged sufficiently.
- The operating instructions of the computer is in hand.
- Depending on the computer you are using, the built-in Bluetooth adapter may need to be turned on. If you do not know how to turn on the Bluetooth adapter or are unsure if your computer has a built-in Bluetooth adapter, refer to the operating instructions supplied with the computer.

1 Enter pairing mode on this headset.

Turn on the headset when you pair the headset with a device for the first time after you bought it or after you initialized the headset (the headset has no pairing information). The headset enters pairing mode automatically. When you pair a 2nd or subsequent device (the headset has pairing information for other devices), press and hold the  button for about 7 seconds.



Check that the blue indicator repeatedly flashes 2 times in a row. You will hear a voice guidance “Bluetooth pairing”.

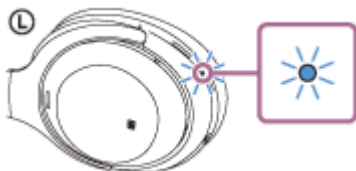

2 Wake the computer up from sleep mode.

3 Register the headset using the computer.

1. Click the [Start] button, then [Settings].
2. Click [Devices].

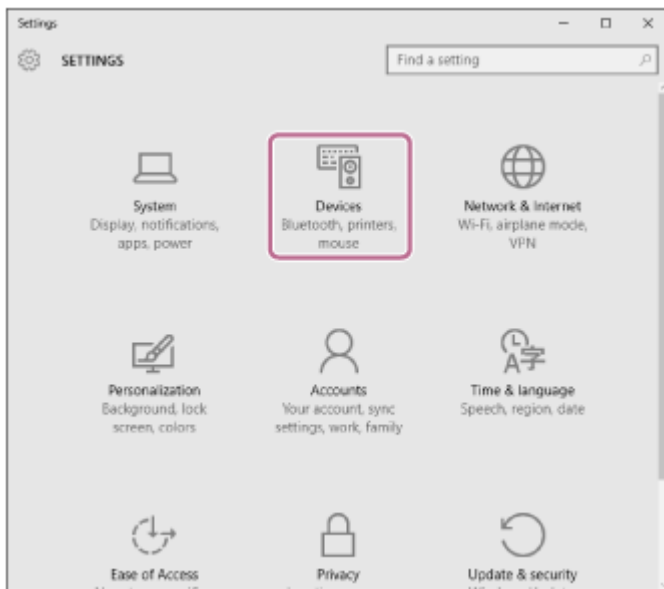

3. Click the [Bluetooth] tab, then click the [Bluetooth] button to turn on the Bluetooth function.

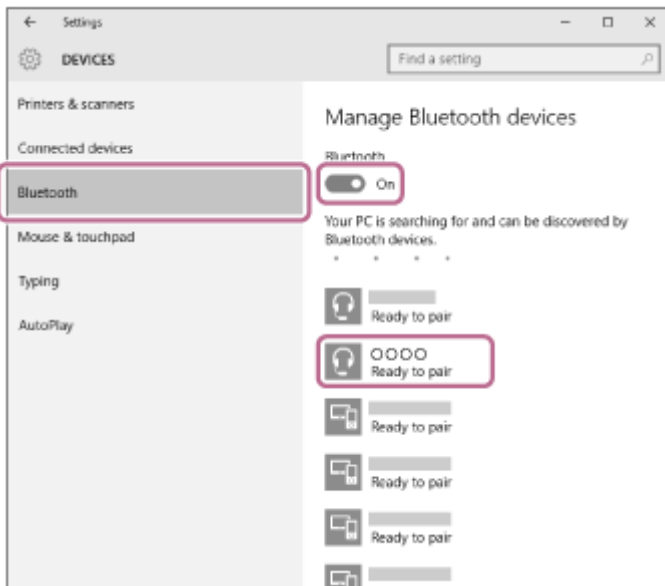

4. Select [WH-1000XM3], then click [Pair].

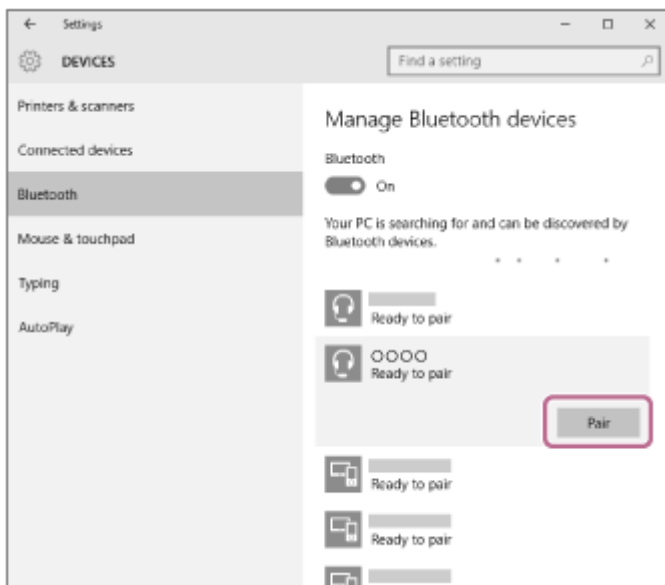

If passkey (*) input is required on the display of the computer, input "0000."
 The headset and computer are paired and connected with each other. You will hear a voice guidance "Bluetooth connected".

If they are not connected, see [“Connecting to a paired computer \(Windows 10\)”](#)

If [WH-1000XM3] does not appear on the display, try again from step 3.

* A Passkey may be called “Passcode,” “PIN code,” or “Password.”

Hint

- The above procedure is an example. For more details, refer to the operating instructions supplied with your computer.
- To delete all pairing information, see [“Initializing the headset to restore factory settings”](#).

Note

- When registering a device (pairing), either [WH-1000XM3] or [LE_WH-1000XM3] or both are displayed on the connecting device. If both or [WH-1000XM3] are displayed touch [WH-1000XM3], or touch [LE_WH-1000XM3] if [LE_WH-1000XM3] is displayed.
- If pairing is not established within 5 minutes, pairing mode is canceled, and the headset turns off. In this case, start the operation over from step 1.
- Once Bluetooth devices are paired, there is no need to pair them again, except in the following cases:
 - Pairing information has been deleted after repair, etc.
 - When a 9th device is paired
The headset can be paired with up to 8 devices. If a new device is paired after 8 devices are already paired, the registration information of the paired device with the oldest connection date is overwritten with the information for the new device.
 - When the pairing information for the headset has been deleted from the Bluetooth device.
 - When the headset is initialized
All of the pairing information is deleted. In this case, delete the pairing information for the headset from the device and then pair them again.
- The headset can be paired with multiple devices, but can only play music from one paired device at a time.

Related Topic

- [How to make a wireless connection to Bluetooth devices](#)
- [Connecting to a paired computer \(Windows 10\)](#)
- [Listening to music from a device via Bluetooth connection](#)
- [Disconnecting Bluetooth connection \(after use\)](#)
- [Initializing the headset to restore factory settings](#)

Pairing and connecting with a computer (Windows 8/Windows 8.1)

The operation to register the device that you wish to connect to is called pairing. First, pair a device to use it with the headset for the first time.

Before you start the pairing operation, make sure that:

- Your computer has a Bluetooth function that supports music playback connections (A2DP).
- The computer is placed within 1 m (3 feet) of the headset.
- The headset is charged sufficiently.
- The operating instructions of the computer is in hand.
- Depending on the computer you are using, the built-in Bluetooth adapter may need to be turned on. If you do not know how to turn on the Bluetooth adapter or are unsure if your computer has a built-in Bluetooth adapter, refer to the operating instructions supplied with the computer.

1 Enter pairing mode on this headset.

Turn on the headset when you pair the headset with a device for the first time after you bought it or after you initialized the headset (the headset has no pairing information). The headset enters pairing mode automatically. When you pair a 2nd or subsequent device (the headset has pairing information for other devices), press and hold the  button for about 7 seconds.



Check that the blue indicator repeatedly flashes 2 times in a row. You will hear a voice guidance "Bluetooth pairing".

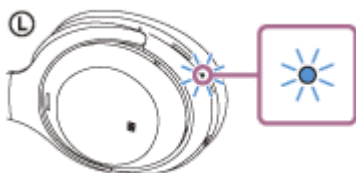

2 Wake the computer up from sleep mode.

3 Register the headset using the computer.

1. Move the mouse pointer to the top-right corner of the screen (when using a touch panel, swipe from the right edge of the screen), then select [Settings] from the Charm Bar.

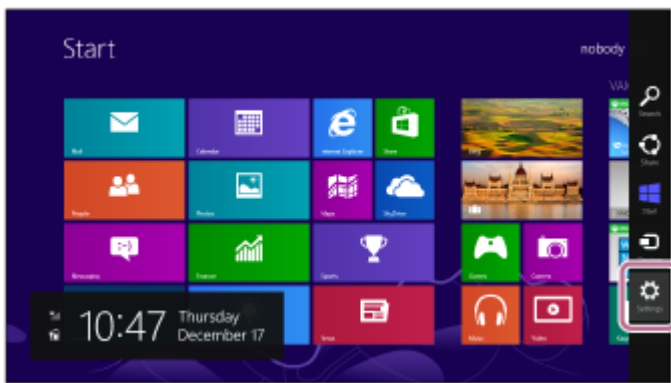

2. Select [Change PC Settings] of the [Settings] charm.

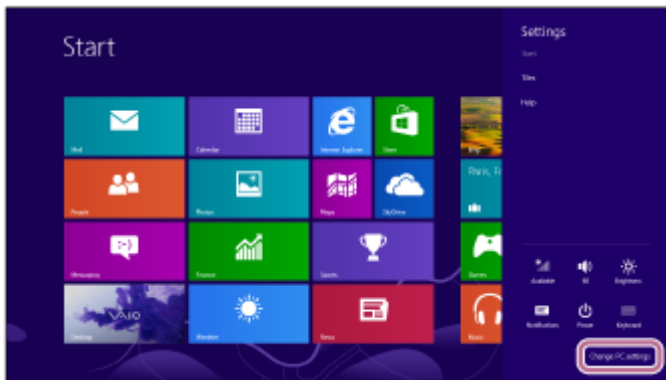

3. Select [PC and devices] of [PC Settings].

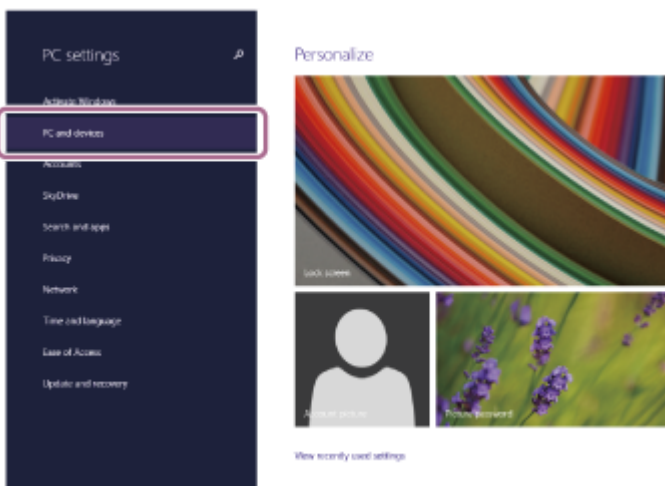

4. Select [Bluetooth].

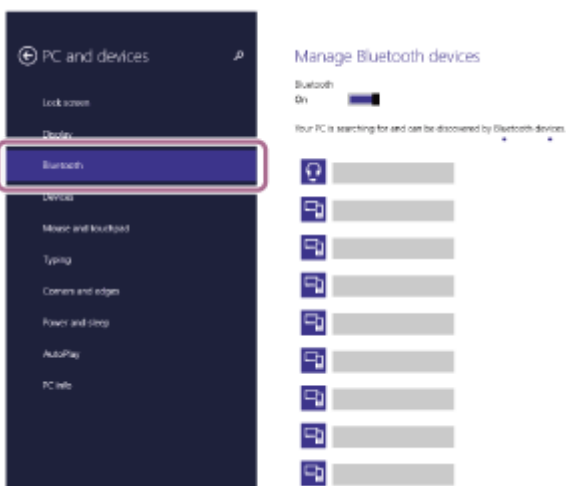

5. Select [WH-1000XM3], then click [Pair].

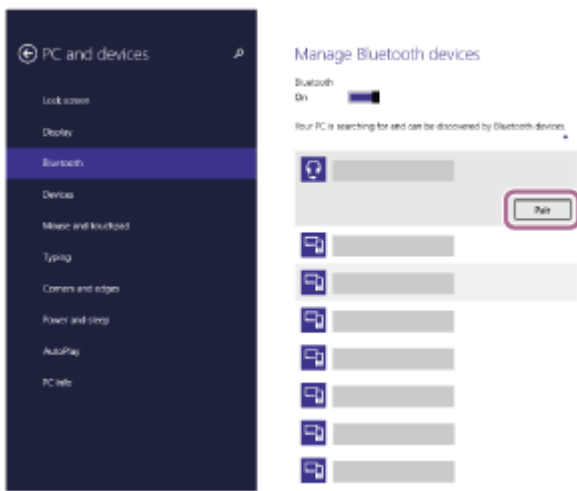

If passkey (*) input is required on the display of the computer, input “0000.”

The headset and computer are paired and connected with each other. You will hear a voice guidance “Bluetooth connected”.

If they are not connected, see [“Connecting to a paired computer \(Windows 8/Windows 8.1\)”](#).

If [WH-1000XM3] does not appear on the display, try again from step 3.

* A Passkey may be called “Passcode,” “PIN code,” or “Password.”

Hint

- The above procedure is an example. For more details, refer to the operating instructions supplied with your computer.
- To delete all Bluetooth pairing information, see [“Initializing the headset to restore factory settings”](#).

Note

- When registering a device (pairing), either [WH-1000XM3] or [LE_WH-1000XM3] or both are displayed on the connecting device. If both or [WH-1000XM3] are displayed touch [WH-1000XM3], or touch [LE_WH-1000XM3] if [LE_WH-1000XM3] is displayed.
- If pairing is not established within 5 minutes, pairing mode is canceled, and the headset turns off. In this case, start the operation over from step 1.
- Once Bluetooth devices are paired, there is no need to pair them again, except in the following cases:
 - Pairing information has been deleted after repair, etc.
 - When a 9th device is paired.
The headset can be paired with up to 8 devices. If a new device is paired after 8 devices are already paired, the registration information of the paired device with the oldest connection date is overwritten with the information for the new device.
 - When the pairing information for the headset has been deleted from the Bluetooth device.
 - When the headset is initialized.
All of the pairing information is deleted. In this case, delete the pairing information for the headset from the device and then pair them again.
- The headset can be paired with multiple devices, but can only play music from one paired device at a time.

Related Topic

- [How to make a wireless connection to Bluetooth devices](#)
- [Connecting to a paired computer \(Windows 8/Windows 8.1\)](#)
- [Listening to music from a device via Bluetooth connection](#)
- [Disconnecting Bluetooth connection \(after use\)](#)
- [Initializing the headset to restore factory settings](#)

Pairing and connecting with a computer (Windows 7)

The operation to register the device that you wish to connect to is called pairing. First, pair a device to use it with the headset for the first time.

Before you start the pairing operation, make sure that:

- Your computer has a Bluetooth function that supports music playback connections (A2DP).
- The computer is placed within 1 m (3 feet) of the headset.
- The headset is charged sufficiently.
- The operating instructions of the computer is in hand.
- Depending on the computer you are using, the built-in Bluetooth adapter may need to be turned on. If you do not know how to turn on the Bluetooth adapter or are unsure if your computer has a built-in Bluetooth adapter, refer to the operating instructions supplied with the computer.

1 Enter pairing mode on this headset.

Turn on the headset when you pair the headset with a device for the first time after you bought it or after you initialized the headset (the headset has no pairing information). The headset enters pairing mode automatically. When you pair a 2nd or subsequent device (the headset has pairing information for other devices), press and hold the  button for about 7 seconds.



Check that the blue indicator repeatedly flashes 2 times in a row. You will hear a voice guidance "Bluetooth pairing".

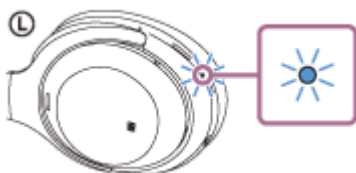

2 Wake the computer up from sleep mode.

3 Search for the headset using the computer.

1. Click the [Start] button, then [Devices and Printers].
2. Click [Add a device].

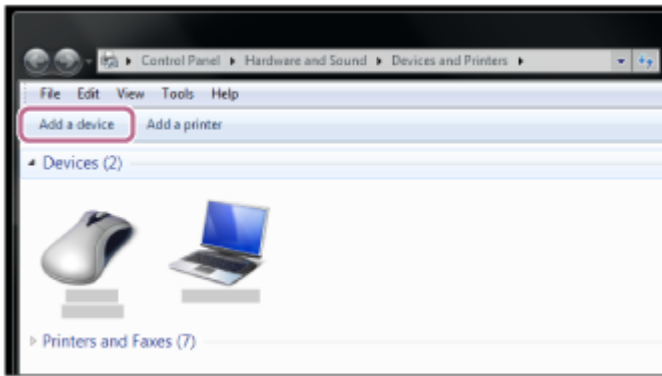

4 Select [WH-1000XM3], then click [Next].

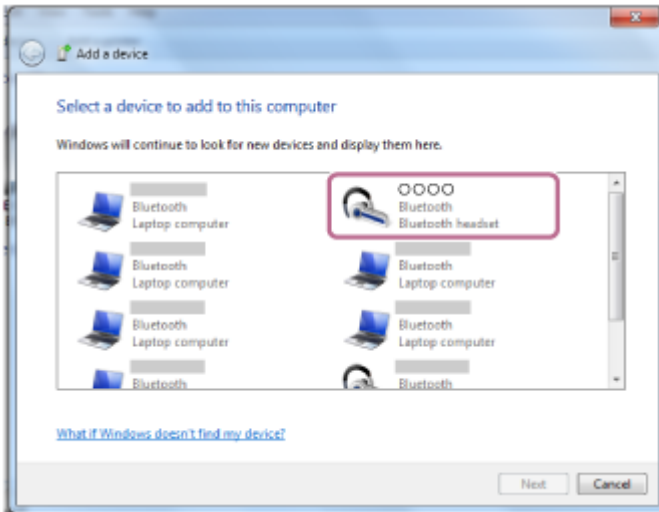

If passkey (*) input is required on the display of the computer, input "0000."

The headset and computer are paired and connected with each other. You will hear a voice guidance "Bluetooth connected".

If they are not connected, see "[Connecting to a paired computer \(Windows 7\)](#)".

If [WH-1000XM3] does not appear on the display, try again from step 3.

* A Passkey may be called "Passcode," "PIN code," or "Password."

Hint

- The above procedure is an example. For more details, refer to the operating instructions supplied with your computer.
- To delete all Bluetooth pairing information, see "[Initializing the headset to restore factory settings](#)".

Note

- When registering a device (pairing), either [WH-1000XM3] or [LE_WH-1000XM3] or both are displayed on the connecting device. If both or [WH-1000XM3] are displayed touch [WH-1000XM3], or touch [LE_WH-1000XM3] if [LE_WH-1000XM3] is displayed.
- If pairing is not established within 5 minutes, pairing mode is canceled, and the headset turns off. In this case, start the operation over from step 1.
- Once Bluetooth devices are paired, there is no need to pair them again, except in the following cases:
 - Pairing information has been deleted after repair, etc.
 - When a 9th device is paired.
The headset can be paired with up to 8 devices. If a new device is paired after 8 devices are already paired, the registration information of the paired device with the oldest connection date is overwritten with the information for the new device.
 - When the pairing information for the headset has been deleted from the Bluetooth device.
 - When the headset is initialized.
All of the pairing information is deleted. In this case, delete the pairing information for the headset from the device and then pair them again.

- The headset can be paired with multiple devices, but can only play music from one paired device at a time.

Related Topic

- [How to make a wireless connection to Bluetooth devices](#)
- [Connecting to a paired computer \(Windows 7\)](#)
- [Listening to music from a device via Bluetooth connection](#)
- [Disconnecting Bluetooth connection \(after use\)](#)
- [Initializing the headset to restore factory settings](#)

4-740-049-11(2) Copyright 2018 Sony Corporation

Pairing and connecting with a computer (Mac)

The operation to register the device that you wish to connect to is called pairing. First, pair a device to use it with the headset for the first time.

Compatible OS

macOS High Sierra (version 10.13)

Before you start the pairing operation, make sure that:

- Your computer has a Bluetooth function that supports music playback connections (A2DP).
- The computer is placed within 1 m (3 feet) of the headset.
- The headset is charged sufficiently.
- The operating instructions of the computer is in hand.
- Depending on the computer you are using, the built-in Bluetooth adapter may need to be turned on. If you do not know how to turn on the Bluetooth adapter or are unsure if your computer has a built-in Bluetooth adapter, refer to the operating instructions supplied with the computer.
- Set the computer speaker to the ON mode.

If the computer speaker is set to the  "OFF" mode, no sound is heard from the headset.
Computer speaker in the ON mode



1 Enter pairing mode on this headset.

Turn on the headset when you pair the headset with a device for the first time after you bought it or after you initialized the headset (the headset has no pairing information). The headset enters pairing mode automatically. When you pair a 2nd or subsequent device (the headset has pairing information for other devices), press and hold the  button for about 7 seconds.



Check that the blue indicator repeatedly flashes two times in a row. You will hear a voice guidance "Bluetooth pairing".

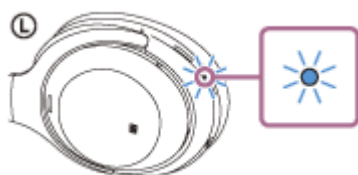

2 Wake the computer up from sleep mode.

3 Register the headset using the computer.

1. Select [ (System Preferences)] - [Bluetooth] from the task bar in the lower right part of the screen.



2. Select [WH-1000XM3] from the Bluetooth screen and click [Connect].



If passkey (*) input is required on the display of the computer, input "0000."

The headset and computer are paired and connected with each other. You will hear a voice guidance "Bluetooth connected".

If they are not connected, see "[Connecting to a paired computer \(Mac\)](#)".

If [WH-1000XM3] does not appear on the display, try again from step 3.

* A Passkey may be called "Passcode," "PIN code," or "Password."

4 Click the speaker icon in the upper right part of the screen and select [WH-1000XM3].

Now you are ready to enjoy music playback on your computer.

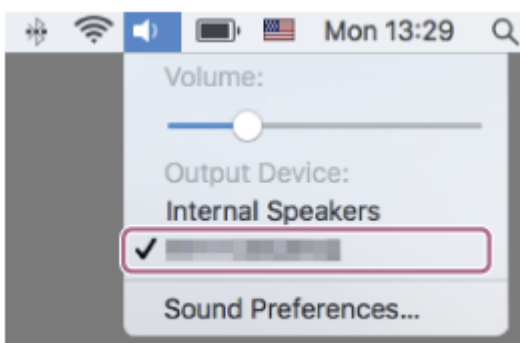

Hint

- The above procedure is an example. For more details, refer to the operating instructions supplied with your computer.
- To delete all pairing information, see "[Initializing the headset to restore factory settings](#)".

Note

- When registering a device (pairing), either [WH-1000XM3] or [LE_WH-1000XM3] or both are displayed on the connecting device. If both or [WH-1000XM3] are displayed touch [WH-1000XM3], or touch [LE_WH-1000XM3] if [LE_WH-1000XM3] is displayed.
- If pairing is not established within 5 minutes, pairing mode is canceled, and the headset turns off. In this case, start the operation over from step 1.
- Once Bluetooth devices are paired, there is no need to pair them again, except in the following cases:
 - Pairing information has been deleted after repair, etc.
 - When a 9th device is paired
The headset can be paired with up to 8 devices. If a new device is paired after 8 devices are already paired, the registration information of the paired device with the oldest connection date is overwritten with the information for the new device.
 - When the pairing information for the headset has been deleted from the Bluetooth device.
 - When the headset is initialized
All of the pairing information is deleted. In this case, delete the pairing information for the headset from the device and then pair them again.
- The headset can be paired with multiple devices, but can only play music from one paired device at a time.

Related Topic

- [How to make a wireless connection to Bluetooth devices](#)
- [Connecting to a paired computer \(Mac\)](#)
- [Listening to music from a device via Bluetooth connection](#)
- [Disconnecting Bluetooth connection \(after use\)](#)
- [Initializing the headset to restore factory settings](#)

Connecting to a paired computer (Windows 10)

Before starting the operation, make sure of the following:

- Depending on the computer you are using, the built-in Bluetooth adapter may need to be turned on. If you do not know how to turn on the Bluetooth adapter or are unsure if your computer has a built-in Bluetooth adapter, refer to the operating instructions supplied with the computer.

1 Wake the computer up from sleep mode.

2 Turn on the headset.

Press and hold the  button for about 2 seconds.



Check that the indicator continues to flash blue after you release your finger from the button. You hear the voice guidance "Power on".

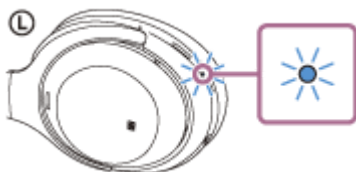

After the headset turns on, if it has automatically connected to the last connected device, you will hear a voice guidance "Bluetooth connected".

Use the computer to check whether the connection is established, and if it is not established, proceed to step 3. If the computer has connected to the last Bluetooth device connected, disconnect it, then proceed to the next step.

3 Select the headset using the computer.

1. Right-click the volume icon on the windows toolbar, then click [Playback devices].

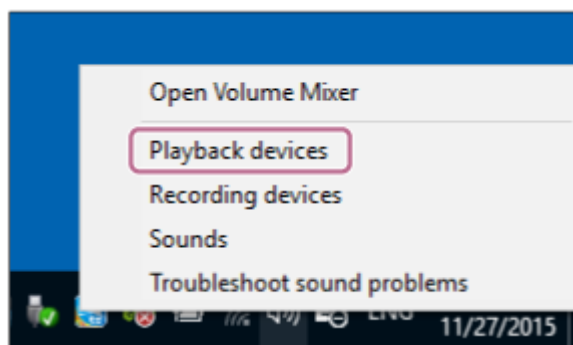

2. Right-click [WH-1000XM3].
If [WH-1000XM3] is not displayed, right-click on the [Sound] screen, then select [Show Disconnected Devices].

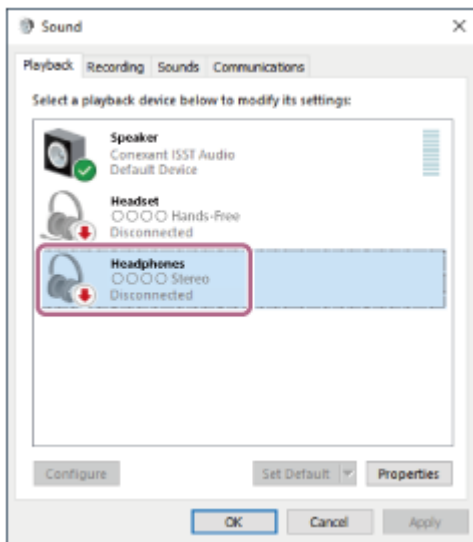

3. Click [Connect].

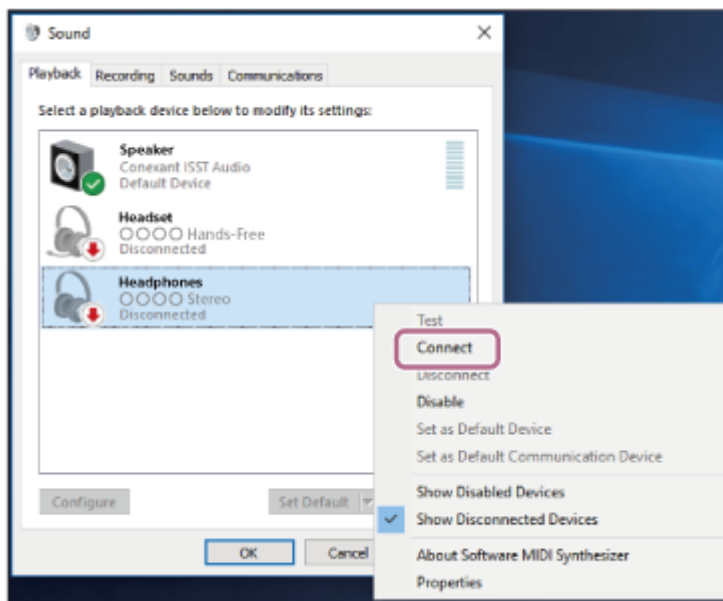

The connection is established.

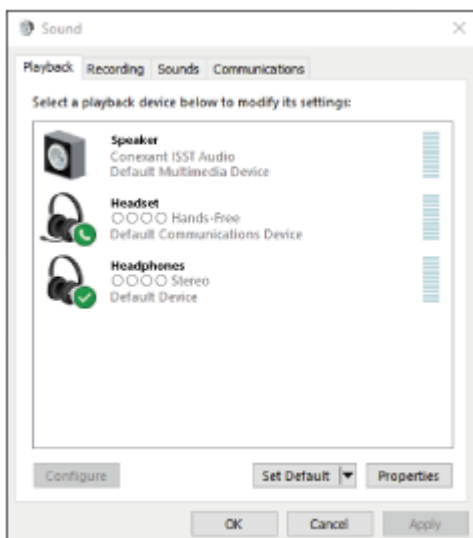

Hint

- The above procedure is an example. For more details, refer to the operating instructions supplied with your computer.

- If the computer was connected with the headset the last time, an HFP/HSP connection is established when you turn on the headset. Double-tap (gently touch it with your finger and immediately release it two times in rapid succession (interval of about 0.4 seconds)) the touch sensor control panel (middle of the right unit) while the headset power is turned on to switch to a music playback connection (A2DP).

Note

- When connecting, either [WH-1000XM3] or [LE_WH-1000XM3] or both are displayed on the connecting device. If both or [WH-1000XM3] are displayed touch [WH-1000XM3], or touch [LE_WH-1000XM3] if [LE_WH-1000XM3] is displayed.
- If the music playback sound quality is poor, check that the A2DP function which supports music playback connections is enabled in the computer settings. For more details, refer to the operating instructions supplied with your computer.
- If the last-connected Bluetooth device is placed near the headset, the headset may connect automatically to the device by simply turning on the headset. In that case, deactivate the Bluetooth function on the device or turn off the power.
- If you cannot connect your computer to the headset, delete the headset pairing information on your computer and perform the pairing again. As for the operations on your computer, refer to the operating instructions supplied with your computer.

Related Topic

- [How to make a wireless connection to Bluetooth devices](#)
- [Pairing and connecting with a computer \(Windows 10\)](#)
- [Listening to music from a device via Bluetooth connection](#)
- [Disconnecting Bluetooth connection \(after use\)](#)

Connecting to a paired computer (Windows 8/Windows 8.1)

Before starting the operation, make sure of the following:

- Depending on the computer you are using, the built-in Bluetooth adapter may need to be turned on. If you do not know how to turn on the Bluetooth adapter or are unsure if your computer has a built-in Bluetooth adapter, refer to the operating instructions supplied with the computer.

1 Wake the computer up from sleep mode.

2 Turn on the headset.

Press and hold the  button for about 2 seconds.



Check that the indicator continues to flash blue after you release your finger from the button. You hear the voice guidance "Power on".

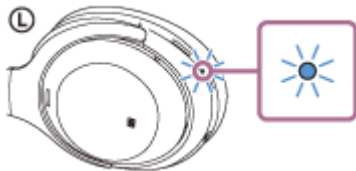

After the headset turns on, if it has automatically connected to the last connected device, you will hear a voice guidance "Bluetooth connected".

Use the computer to check whether the connection is established, and if it is not established, proceed to step 3.

If the computer has connected to the last Bluetooth device connected, disconnect it, then proceed to the next step.

3 Select the headset using the computer.

1. Select [Desktop] on the Start screen.
2. Right-click the [Start] button, then select [Control Panel] from the pop-up menu.
3. Select [Hardware and Sound], then [Sound].

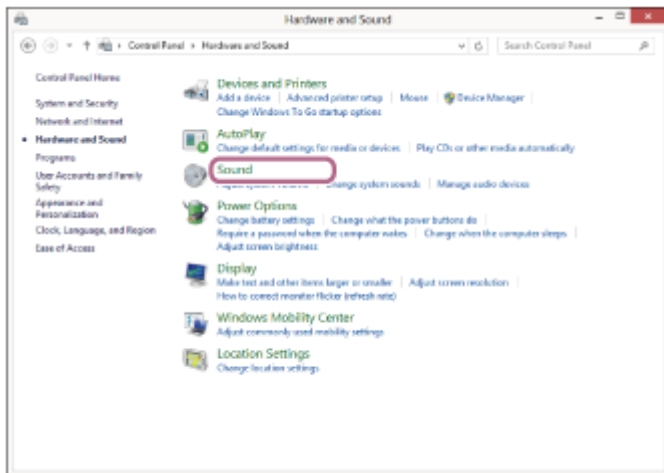
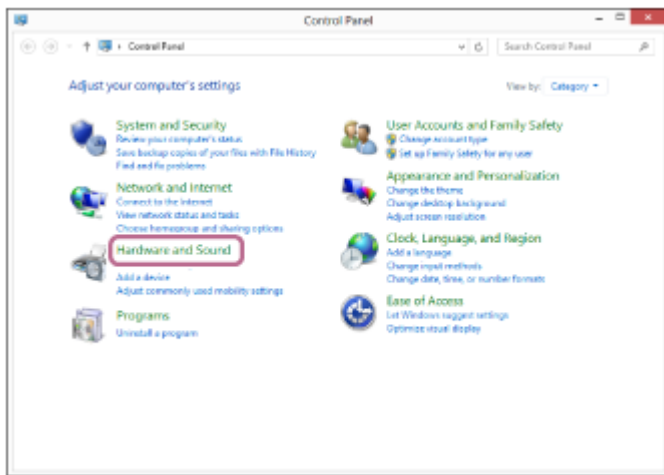

4. Right-click [WH-1000XM3].
If [WH-1000XM3] is not displayed on the [Sound] screen, right-click on the [Sound] screen, then select [Show Disconnected Devices].

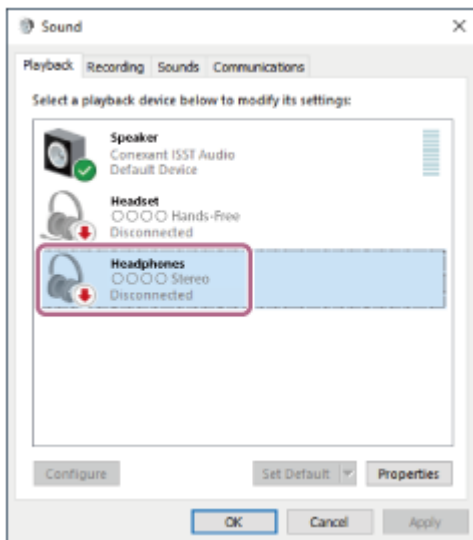

5. Select [Connect] from the displayed menu.

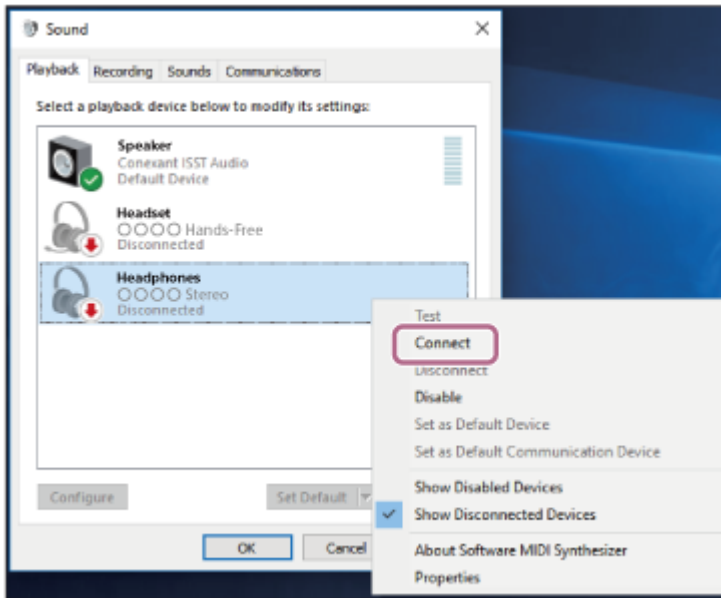

The connection is established. You will hear a voice guidance “Bluetooth connected”.

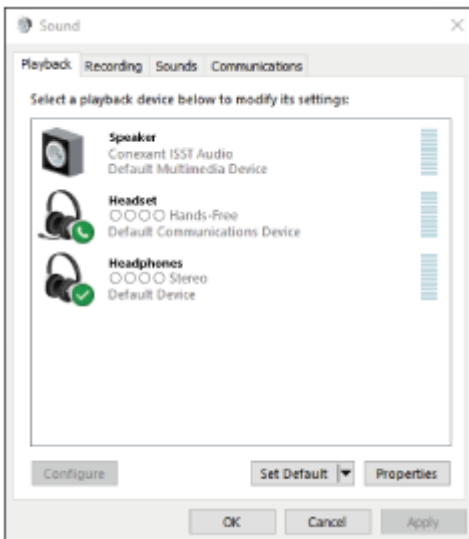

Hint

- The above procedure is an example. For more details, refer to the operating instructions supplied with your computer.
- If the computer was connected with the headset the last time, an HFP/HSP connection is established when you turn on the headset. Double-tap (gently touch it with your finger and immediately release it two times in rapid succession (interval of about 0.4 seconds)) the touch sensor control panel (middle of the right unit) while the headset power is turned on to switch to a music playback connection (A2DP).

Note

- When connecting, either [WH-1000XM3] or [LE_WH-1000XM3] or both are displayed on the connecting device. If both or [WH-1000XM3] are displayed touch [WH-1000XM3], or touch [LE_WH-1000XM3] if [LE_WH-1000XM3] is displayed.
- If the music playback sound quality is poor, check that the A2DP function which supports music playback connections is enabled in the computer settings. For more details, refer to the operating instructions supplied with your computer.
- If the last-connected Bluetooth device is placed near the headset, the headset may connect automatically to the device by simply turning on the headset. In that case, deactivate the Bluetooth function on the device or turn off the power.
- If you cannot connect your computer to the headset, delete the headset pairing information on your computer and perform the pairing again. As for the operations on your computer, refer to the operating instructions supplied with your computer.

Related Topic

- [How to make a wireless connection to Bluetooth devices](#)
- [Pairing and connecting with a computer \(Windows 8/Windows 8.1\)](#)
- [Listening to music from a device via Bluetooth connection](#)
- [Disconnecting Bluetooth connection \(after use\)](#)

4-740-049-11(2) Copyright 2018 Sony Corporation

Connecting to a paired computer (Windows 7)

Before starting the operation, make sure of the following:

- Depending on the computer you are using, the built-in Bluetooth adapter may need to be turned on. If you do not know how to turn on the Bluetooth adapter or are unsure if your computer has a built-in Bluetooth adapter, refer to the operating instructions supplied with the computer.

1 Wake the computer up from sleep mode.

2 Turn on the headset.

Press and hold the  button for about 2 seconds.



Check that the indicator continues to flash blue after you release your finger from the button. You hear the voice guidance “Power on”.

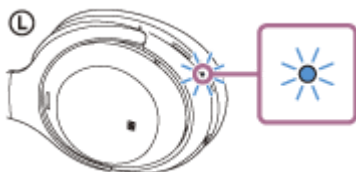

After the headset turns on, if it has automatically connected to the last connected device, you will hear a voice guidance “Bluetooth connected”.

Use the computer to check whether the connection is established, and if it is not established, proceed to step 3. If the computer has connected to the last Bluetooth device connected, disconnect it, then proceed to the next step.

3 Select the headset using the computer.

1. Click the [Start] button, then [Devices and Printers].
2. Double-click [WH-1000XM3] of [Devices].



Click [Listen to Music].

3.

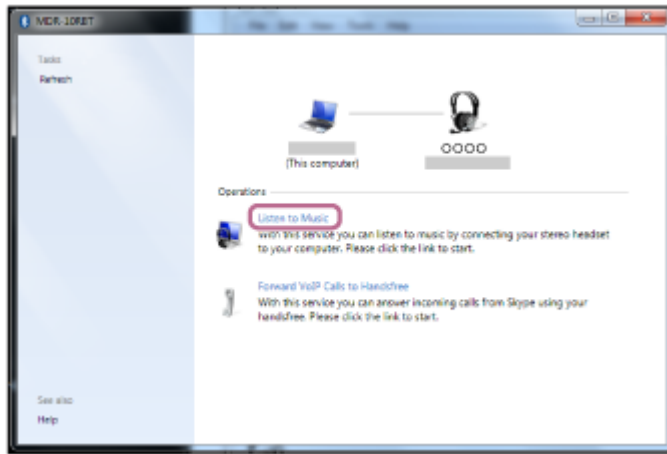

Hint

- The above procedure is an example. For more details, refer to the operating instructions supplied with your computer.
- If the computer was connected with the headset the last time, an HFP/HSP connection is established when you turn on the headset. Double-tap (gently touch it with your finger and immediately release it two times in rapid succession (interval of about 0.4 seconds)) the touch sensor control panel (middle of the right unit) while the headset power is turned on to switch to a music playback connection (A2DP).

Note

- When connecting, either [WH-1000XM3] or [LE_WH-1000XM3] or both are displayed on the connecting device. If both or [WH-1000XM3] are displayed touch [WH-1000XM3], or touch [LE_WH-1000XM3] if [LE_WH-1000XM3] is displayed.
- If the music playback sound quality is poor, check that the A2DP function which supports music playback connections is enabled in the computer settings. For more details, refer to the operating instructions supplied with your computer.
- If the last-connected Bluetooth device is placed near the headset, the headset may connect automatically to the device by simply turning on the headset. In that case, deactivate the Bluetooth function on the device or turn off the power.
- If you cannot connect your computer to the headset, delete the headset pairing information on your computer and perform the pairing again. As for the operations on your computer, refer to the operating instructions supplied with your computer.

Related Topic

- [How to make a wireless connection to Bluetooth devices](#)
- [Pairing and connecting with a computer \(Windows 7\)](#)
- [Listening to music from a device via Bluetooth connection](#)
- [Disconnecting Bluetooth connection \(after use\)](#)

Connecting to a paired computer (Mac)

Compatible OS

macOS High Sierra (version 10.13)

Before starting the operation, make sure of the following:

- Depending on the computer you are using, the built-in Bluetooth adapter may need to be turned on. If you do not know how to turn on the Bluetooth adapter or are unsure if your computer has a built-in Bluetooth adapter, refer to the operating instructions supplied with the computer.
- Set the computer speaker to the ON mode.
If the computer speaker is set to the  "OFF" mode, no sound is heard from the headset.
Computer speaker in the ON mode



1 Wake the computer up from sleep mode.

2 Turn on the headset.

Press and hold the  button for about 2 seconds.



Check that the indicator continues to flash blue after you release your finger from the button. You hear the voice guidance "Power on".

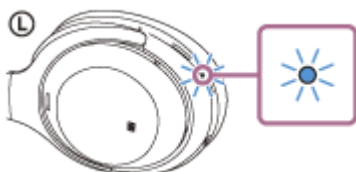

After the headset turns on, if it has automatically connected to the last connected device, you will hear a voice guidance "Bluetooth connected".

Use the computer to check whether the connection is established, and if it is not established, proceed to step 3.

If the computer has connected to the last Bluetooth device connected, disconnect it, then proceed to the next step.

3 Select the headset using the computer.

1. Select [ (System Preferences)] - [Bluetooth] from the task bar in the lower right part of the screen.



- Click [WH-1000XM3] while pressing the computer Control button on the Bluetooth screen and select [Connect] from the pop up menu.



- Click the speaker icon in the upper right part of the screen and select [WH-1000XM3].

Now you are ready to enjoy music playback on your computer.

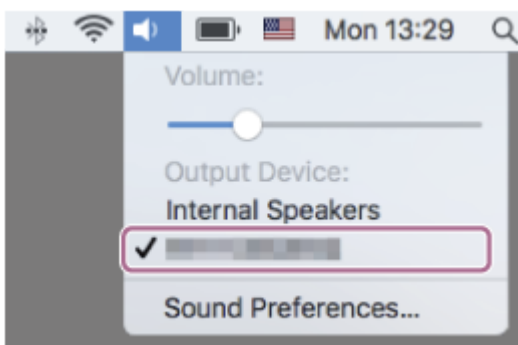

Hint

- The above procedure is an example. For more details, refer to the operating instructions supplied with your computer.
- If the computer was connected with the headset the last time, an HFP/HSP connection is established when you turn on the headset. Double-tap (gently touch it with your finger and immediately release it two times in rapid succession (interval of about 0.4 seconds)) the touch sensor control panel (middle of the right unit) while the headset power is turned on to switch to a music playback connection (A2DP).

Note

- When connecting, either [WH-1000XM3] or [LE_WH-1000XM3] or both are displayed on the connecting device. If both or [WH-1000XM3] are displayed touch [WH-1000XM3], or touch [LE_WH-1000XM3] if [LE_WH-1000XM3] is displayed.

- If the music playback sound quality is poor, check that the A2DP function which supports music playback connections is enabled in the computer settings. For more details, refer to the operating instructions supplied with your computer.
- If the last-connected Bluetooth device is placed near the headset, the headset may connect automatically to the device by simply turning on the headset. In that case, deactivate the Bluetooth function on the device or turn off the power.
- If you cannot connect your computer to the headset, delete the headset pairing information on your computer and perform the pairing again. As for the operations on your computer, refer to the operating instructions supplied with your computer.

Related Topic

- [How to make a wireless connection to Bluetooth devices](#)
- [Pairing and connecting with a computer \(Mac\)](#)
- [Listening to music from a device via Bluetooth connection](#)
- [Disconnecting Bluetooth connection \(after use\)](#)

Wireless Noise Canceling Stereo Headset
WH-1000XM3

Pairing and connecting with other Bluetooth devices

The operation to register the device that you wish to connect to is called pairing. First, pair a device to use it with the headset for the first time.

Before you start the pairing operation, make sure that:

- The Bluetooth device is placed within 1 m (3 feet) of the headset.
- The headset is charged sufficiently.
- The operating instructions of the Bluetooth device is in hand.

1 Enter pairing mode on this headset.

Turn on the headset when you pair the headset with a device for the first time after you bought it or after you initialized the headset (the headset has no pairing information). The headset enters pairing mode automatically. When you pair a 2nd or subsequent device (the headset has pairing information for other devices), press and hold the  button for about 7 seconds.



Check that the blue indicator repeatedly flashes 2 times in a row. You will hear a voice guidance “Bluetooth pairing”.

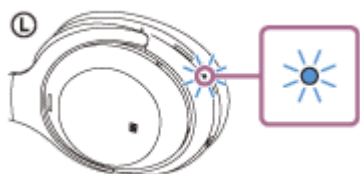

2 Perform the pairing procedure on the Bluetooth device to search for this headset.

[WH-1000XM3] will be displayed on the list of detected devices on the screen of the Bluetooth device. If it is not displayed, repeat from step 1.

3 Select [WH-1000XM3] displayed on the screen of the Bluetooth device for pairing.

If passkey (*) input is required on the display of the computer, input “0000.”

* A Passkey may be called “Passcode,” “PIN code,” or “Password.”

4 Make the Bluetooth connection from the Bluetooth device.

Some devices automatically connect with the headset when the pairing is complete. You will hear a voice guidance “Bluetooth connected”.

Hint

- The above procedure is an example. For more details, refer to the operating instructions supplied with your Bluetooth device.
- To delete all Bluetooth pairing information, see [“Initializing the headset to restore factory settings”](#).

Note

- When registering a device (pairing), either [WH-1000XM3] or [LE_WH-1000XM3] or both are displayed on the connecting device. If both or [WH-1000XM3] are displayed touch [WH-1000XM3], or touch [LE_WH-1000XM3] if [LE_WH-1000XM3] is displayed.
- If pairing is not established within 5 minutes, pairing mode is canceled, and the headset turns off. In this case, start the operation over from step 1.
- Once Bluetooth devices are paired, there is no need to pair them again, except in the following cases:
 - Pairing information has been deleted after repair, etc.
 - When a 9th device is paired.
The headset can be paired with up to 8 devices. If a new device is paired after 8 devices are already paired, the registration information of the paired device with the oldest connection date is overwritten with the information for the new device.
 - When the pairing information for the headset has been deleted from the Bluetooth device.
 - When the headset is initialized.
All of the pairing information is deleted. In this case, delete the pairing information for the headset from the device and then pair them again.
- The headset can be paired with multiple devices, but can only play music from one paired device at a time.

Related Topic

- [How to make a wireless connection to Bluetooth devices](#)
- [Connecting to a paired Bluetooth device](#)
- [Listening to music from a device via Bluetooth connection](#)
- [Initializing the headset to restore factory settings](#)

Connecting to a paired Bluetooth device

1 Turn on the headset.

Press and hold the  button for about 2 seconds.



Check that the indicator continues to flash blue after you release your finger from the button. You hear the voice guidance “Power on”.

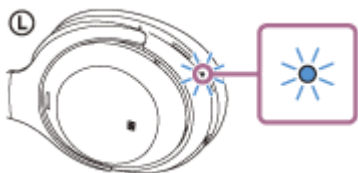

After the headset turns on, if it has automatically connected to the last connected device, you will hear a voice guidance “Bluetooth connected”.

Check the connection status on the Bluetooth device. If it is not connected, proceed to step 2.

2 Make the Bluetooth connection from the Bluetooth device.

Refer to the operations in the operating instructions supplied with your Bluetooth device. When connected, you will hear a voice guidance “Bluetooth connected”.

Hint

- The above procedure is an example. For more details, refer to the operating instructions supplied with your Bluetooth device.
- If the Bluetooth device was connected with the headset the last time, an HFP/HSP connection is established when you turn on the headset. Double-tap (gently touch it with your finger and immediately release it two times in rapid succession (interval of about 0.4 seconds)) the middle of the right unit housing (touch sensor control panel) while the headset power is turned on to switch to a music playback connection (A2DP).

Note

- When connecting, either [WH-1000XM3] or [LE_WH-1000XM3] or both are displayed on the connecting device. If both or [WH-1000XM3] are displayed touch [WH-1000XM3], or touch [LE_WH-1000XM3] if [LE_WH-1000XM3] is displayed.
- If the last-connected Bluetooth device is placed near the headset, the headset may connect automatically to the device by simply turning on the headset. In that case, deactivate the Bluetooth function on the device or turn off the power.
- If you cannot connect your Bluetooth device to the headset, delete the headset pairing information on your Bluetooth device and perform the pairing again. As for the operations on your Bluetooth device, refer to the operating instructions supplied with your device.

Related Topic

- [How to make a wireless connection to Bluetooth devices](#)
- [Pairing and connecting with other Bluetooth devices](#)
- [Listening to music from a device via Bluetooth connection](#)

4-740-049-11(2) Copyright 2018 Sony Corporation

Connecting the headset to both a music player and a smartphone or mobile phone

Multipoint is a function which allows you to connect two Bluetooth devices to the headset and use one device for music playback (A2DP connection) and the other for talking (HFP/HSP connection).

When you wish to use a music player only for music playback and a smartphone only for talking, use a multipoint connection to the headset for each device. The connecting devices must support the Bluetooth function.

1 Pair the headset with both the music player and the smartphone/mobile phone.

2 Connect the headset with the music player.

Operate the music player to establish a Bluetooth connection with the headset.

3 Connect the headset to a smartphone or mobile phone.

Operate the smartphone/mobile phone to establish a Bluetooth connection with the headset.

Note

- If the smartphone or mobile phone was connected with the headset the last time, an HFP or HSP connection is automatically established when the headset is turned on, and in some cases an A2DP connection is simultaneously established. In that case, connect from step 2 after disconnecting via smartphone/mobile phone operations.
- When using the Google Assistant, the headset cannot make a multipoint connection.

Wireless Noise Canceling Stereo Headset
WH-1000XM3

Connecting the headset to 2 Android smartphones

Usually when you connect the headset to a smartphone, the music playback function and the phone call function are both connected simultaneously.

To make a multipoint connection using two smartphones for separately listening to music and making phone calls, change the settings on the smartphone so that only one of the functions is connected.

- 1 Pair the headset with both smartphones, respectively.
- 2 Use one of the smartphones to establish a Bluetooth connection with the headset.
- 3 On the smartphone connected to the headset, uncheck either [Call audio] (HFP) or [Media audio] (A2DP).

Operation example: When only connecting to a media audio (A2DP)

Touch [Settings] - [Bluetooth] - the setting icon next to [WH-1000XM3].

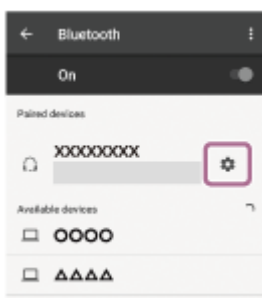

On the [Paired devices] screen, uncheck [Call audio].



- 4 Terminate the Bluetooth connection of the smartphone.
- 5 Use the other smartphone to establish a Bluetooth connection to the headset.
- 6 In the same way, uncheck the function that you did not uncheck in step 3.
- 7 Use the first smartphone to establish a Bluetooth connection again.

Both smartphones are connected to the headset with only one function enabled.

Hint

- The above procedure is an example. For more details, refer to the operating instructions supplied with your Android smartphone.

Note

- When using the Google Assistant, the headset cannot make a multipoint connection.

4-740-049-11(2) Copyright 2018 Sony Corporation

Connecting the headset to an Android smartphone and an iPhone

Usually when you connect the headset to a smartphone, the music playback function and the phone call function are both connected simultaneously.

To make a multipoint connection using an Android smartphone and iPhone for separately listening to music and making phone calls, change the settings on the Android smartphone so that only one of the functions is connected. Connect the Android smartphone before connecting the iPhone.

You cannot set the iPhone to connect one function only.

- 1 **Pair the headset with both Android smartphone and iPhone, respectively.**
- 2 **Use the Android smartphone to establish a Bluetooth connection with the headset.**
- 3 **On the smartphone connected to the headset, uncheck either [Call audio] (HFP) or [Media audio] (A2DP).**

Operation example: When only connecting to a media audio (A2DP)

Touch [Settings] - [Bluetooth] - the setting icon next to [WH-1000XM3].

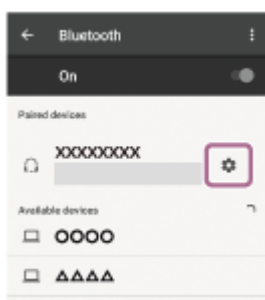

On the [Paired devices] screen, uncheck [Call audio].



- 4 **Use the iPhone to establish a Bluetooth connection to the headset.**

The iPhone is connected with the function unchecked in step 3.

Hint

- The above procedure is an example. For more details, refer to the operating instructions supplied with your Android smartphone.

Note

- If you connect an Android smartphone with "Call audio" (HFP), the remaining battery charge of the headset will not be correctly displayed on the iPhone screen.

- When using the Google Assistant, the headset cannot make a multipoint connection.

4-740-049-11(2) Copyright 2018 Sony Corporation

Disconnecting Bluetooth connection (after use)

- 1 Touch the one-touch connection (NFC) compatible device once more to disconnect it. (Unlock the screen of the device if it is locked.) If the Bluetooth device does not support one-touch connection (NFC), operate from the device to disconnect.**

When disconnected, you will hear a voice guidance "Bluetooth disconnected".

- 2 Turn off the headset.**

You will hear a voice guidance "Power off".

Hint

- When you finish playing music, the Bluetooth connection may terminate automatically depending on the Bluetooth device.

Related Topic

- [Disconnecting the Android smartphone with one-touch \(NFC\)](#)
- [Turning off the headset](#)

Using the supplied headphone cable

If you use the headset at a place where it is restricted to use Bluetooth devices such as on an airplane, you can use the headset as noise canceling headphones by connecting a device via the supplied headphone cable and turning the headset on.

The headset supports high resolution audio playback.

1 Connect a playback device to the INPUT jack with the supplied headphone cable.

Be sure to connect the L-shaped plug into the connecting device.

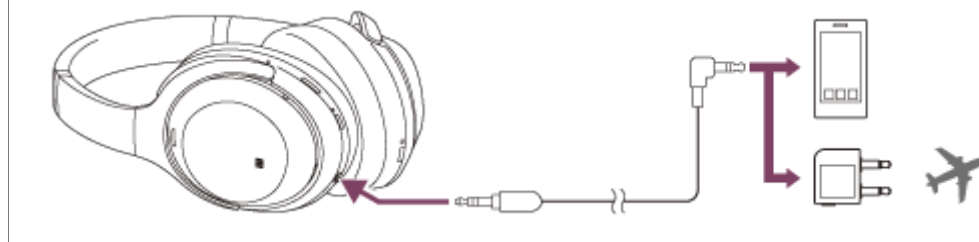

Hint

- You can listen to music even if the headset is turned off. In this case, the noise canceling function cannot be used.
- To enjoy high resolution audio music or use the noise canceling function/Ambient Sound Mode, turn the headset on.
- Use the supplied plug adapter for in-flight use to enjoy the in-flight entertainment.
- The headset turns off automatically if you disconnect the supplied headphone cable from the headset while it is turned on.
- When an incoming call arrives, a ring tone is heard via the headset. Answer the call using your smartphone or mobile phone, and talk using the microphone of the phone. You can hear the caller's voice from the headset.
- If you disconnect the headphone cable from the smartphone or mobile phone, you can talk using the microphone and speaker of the phone.

Note

- Use the supplied headphone cable only.
- Make sure you insert the plug firmly.
- When using the headphone cable the Bluetooth function cannot be used.
- You can operate the touch sensor control panel only for Quick Attention Mode. Adjust the volume, playback/pause, and other operations on the playback device.
- The NC/AMBIENT button cannot be used when the headset is powered off.
- Depending on the in-flight entertainment, the plug adaptor for in-flight use may not be used.

Wireless Noise Canceling Stereo Headset
WH-1000XM3

Listening to music from a device via Bluetooth connection

If your Bluetooth device supports the following profiles, you can enjoy listening to music and perform basic remote control operation of the Bluetooth device via a Bluetooth connection.

- A2DP (Advanced Audio Distribution Profile)
You can enjoy high-quality music wirelessly.
- AVRCP (Audio Video Remote Control Profile)
You can adjust the volume, etc.

The operation may vary depending on the Bluetooth device. Refer to the operating instructions supplied with your Bluetooth device.

1 Connect the headset to a Bluetooth device.

2 Wear the headset.

Adjust the length of the headband.

Put the headset on your head with the **L** indication on your left ear and the **R** indication on your right ear. The **L** unit has a tactile dot.

Be careful not to come in contact with the touch sensor control panel when you wear the headset.

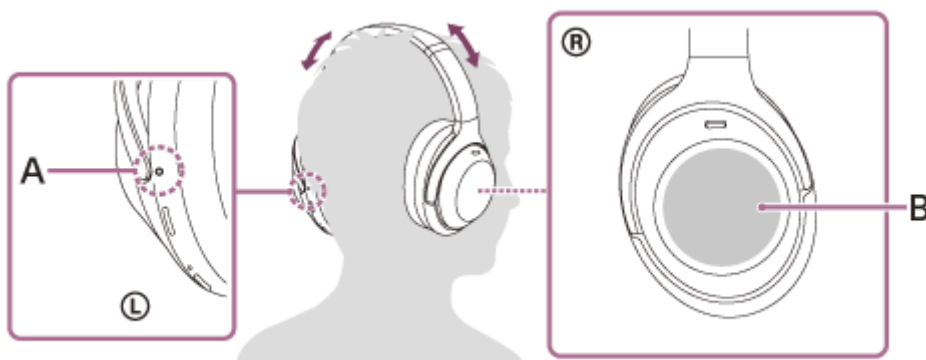

A: Tactile dot

B: Touch sensor control panel

3 Play back music or video on the Bluetooth device.

Adjust the volume on the Bluetooth device.

4 Control the volume by operating the touch sensor control panel.

- To increase the volume: Swipe up repeatedly until the volume reaches the desired level.



- To decrease the volume: Swipe down repeatedly until the volume reaches the desired level.



- If you hold your finger to the touch sensor control panel after swiping up or down, the volume continues to change.

When the volume reaches the maximum or minimum, an alarm sounds.

Hint

- The headset supports SCMS-T content protection. You can enjoy music and other audio on the headset from a device such as a portable TV that supports SCMS-T content protection.
- Depending on the Bluetooth device, it may be necessary to adjust the volume or set the audio output setting on the Bluetooth device.
- The headset volume during a call and during music playback can be independently adjusted. Changing the call volume does not change the volume of music playback and vice versa.

Note

- If the communication condition is poor, the Bluetooth device may react incorrectly to the operation on the headset.

Related Topic

- [How to make a wireless connection to Bluetooth devices](#)
- [Controlling the audio device \(Bluetooth connection\)](#)
- [Using the noise canceling function](#)

Wireless Noise Canceling Stereo Headset
WH-1000XM3

Controlling the audio device (Bluetooth connection)

If your Bluetooth device supports the device operating function (compatible protocol: AVRCP), then the following operations are available. The available functions may vary depending on the Bluetooth device, so refer to the operating instructions supplied with your device.

You can use the touch sensor control panel to perform the following operations.

- Play/Pause: Gently touch it with your finger and immediately release it two times in rapid succession (interval of about 0.4 seconds) (Double tap)

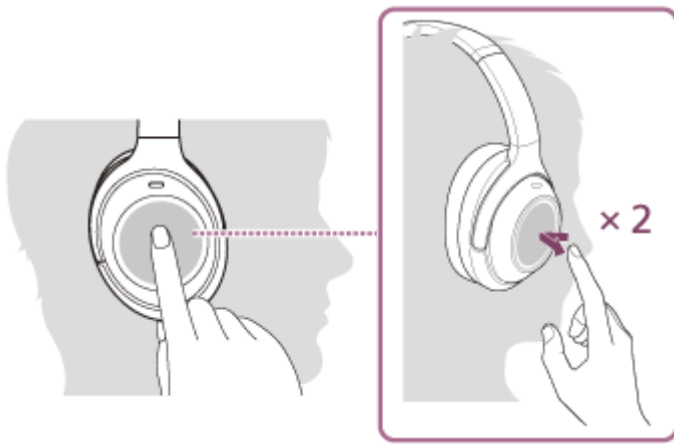

- Next track: Swipe forward.



- Previous track: Swipe backward.

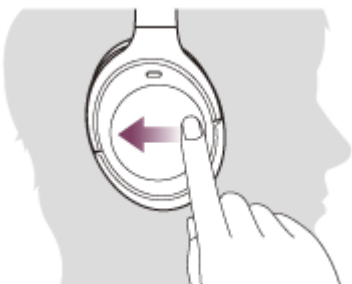

- Fast-forward: Swipe forward and hold. (It takes a while until fast-forwarding starts.) Release at the desired playback point.



- Fast-reverse: Swipe backward and hold. (It takes a while until fast-reversing starts.) Release at the desired playback point.



- To increase the volume: Swipe up repeatedly until the volume reaches the desired level.



- To decrease the volume: Swipe down repeatedly until the volume reaches the desired level.



- If you hold your finger to the touch sensor control panel after swiping up or down, the volume continues to change.

Note

- If the communication condition is poor, the Bluetooth device may react incorrectly to the operation on the headset.
- The available functions may vary depending on the connected device. In some cases, it may operate differently or may not work at all when the operations described above are performed.

Disconnecting Bluetooth connection (after use)

- 1 Touch the one-touch connection (NFC) compatible device once more to disconnect it. (Unlock the screen of the device if it is locked.) If the Bluetooth device does not support one-touch connection (NFC), operate from the device to disconnect.**

When disconnected, you will hear a voice guidance "Bluetooth disconnected".

- 2 Turn off the headset.**

You will hear a voice guidance "Power off".

Hint

- When you finish playing music, the Bluetooth connection may terminate automatically depending on the Bluetooth device.

Related Topic

- [Disconnecting the Android smartphone with one-touch \(NFC\)](#)
- [Turning off the headset](#)

Wireless Noise Canceling Stereo Headset
WH-1000XM3

What is noise canceling?

The noise canceling circuit actually senses outside noise with built-in microphones and sends an equal-but-opposite canceling signal to the headset.

Note

- The noise canceling effect may not be pronounced in a very quiet environment, or some noise may be heard.
- Depending on how you wear the headset, the noise canceling effect may vary or a beeping sound (feedback) may be heard. In this case, take off the headset and put it on again.
- The noise canceling function works primarily on noise in the low frequency band. Although noise is reduced, it is not completely canceled.
- When you use the headset in a train or a car, noise may occur depending on street conditions.
- Mobile phones may cause interference and noise. Should this occur, move the headset further away from the mobile phone.
- Do not cover the headset microphone with your hand. The noise canceling function or the Ambient Sound Mode may not work properly, or a beeping sound (feedback) may occur. In this case, remove your hand from the headset microphone.



A: Noise canceling function microphone (external)

Related Topic

- [Using the noise canceling function](#)

Wireless Noise Canceling Stereo Headset
WH-1000XM3

Using the noise canceling function

If you use the noise canceling function, you can enjoy music without being disturbed by ambient noise.

1 Turn on the headset.

You hear the voice guidance "Power on".

The noise canceling function is turned on automatically when you turn on the headset.

To turn off the noise canceling function

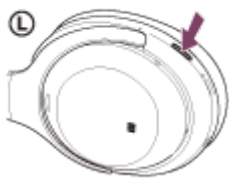

Press the NC/AMBIENT button repeatedly until the noise canceling function is turned off.
Each time the button is pressed, the function switches as follows and is announced by the voice guidance.

The Ambient Sound Mode: ON



The noise canceling function/Ambient Sound Mode: OFF



The noise canceling function: ON/Ambient Sound Mode: OFF

Hint

- If you use the noise canceling function with a Bluetooth connection, the noise canceling function is on even if you connect the supplied headphone cable.
- When you use the headset as ordinary headphones, turn off the headset and use the supplied headphone cable.
- You can also change the settings of the noise canceling function and the Ambient Sound Mode with the "Sony | Headphones Connect" app.

Note

- If the NC/AMBIENT button is set as the Google Assistant button, the noise canceling function cannot be switched by pressing the NC/AMBIENT button. You can also change the settings of the noise canceling function and the Ambient Sound Mode with the "Sony | Headphones Connect" app.
- When the headset is connected with the headphone cable, the indicator next to the  button turns off.

Related Topic

- [About voice guidance](#)
- [Turning on the headset](#)
- [What is noise canceling?](#)
- [Listening to ambient sound during music playback \(Ambient Sound Mode\)](#)
- [What you can do with "Sony | Headphones Connect" app](#)

4-740-049-11(2) Copyright 2018 Sony Corporation

Wireless Noise Canceling Stereo Headset
WH-1000XM3

Optimizing the noise canceling function to suit the wearer (NC Optimizer)

This function optimizes the noise canceling function by detecting the shape of your face, your hairstyle, the headset attaching condition based on the absence or presence of glasses, or the pressure change in an airplane. It is recommended that you run the optimizer when using the headset for the first time or when the air pressure changes in an airplane.

- 1 **Wear the headset with the power turned on.**



- 2 **Press and hold the NC/AMBIENT button until you hear voice guidance "Optimizer start" (about 2 seconds).**



Test signals can be heard during the optimization. When the optimization is finished, you will hear a voice guidance "Optimizer finished".

Hint

- It is recommended that you run the NC Optimizer again after changing your hairstyle, removing eyeglasses worn on a daily basis, or implementing other changes to the wearing conditions.
- If you are on an airplane, it is recommended that you turn on the NC Optimizer function when the airplane reaches a stable flight condition.
- The condition set with the NC Optimizer function is retained until the optimization is run again. It is recommended that you turn on the NC Optimizer function once again after getting off the airplane.
- The NC Optimizer can also be operated from the "Sony | Headphones Connect" app.

Note

- Wear the headset under the actual usage conditions during the optimization. It is recommended that you do not touch the headset during the optimization.
- The optimization is canceled when the headset receives another operation command during the optimization.
- If the NC/AMBIENT button is set as the Google Assistant button, the NC Optimizer function cannot be operated from the headset.

Wireless Noise Canceling Stereo Headset
WH-1000XM3

Listening to ambient sound during music playback (Ambient Sound Mode)

You can hear ambient sound through the microphones embedded in the left/right units of the headset while enjoying music.

To activate the Ambient Sound Mode

Press the NC/AMBIENT button while the noise canceling function is on.

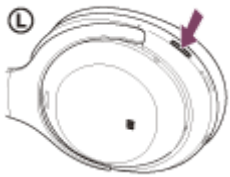

To change the setting of the Ambient Sound Mode

You can set up the Ambient Sound Mode by connecting the smartphone (with the “Sony | Headphones Connect” app installed) and the headset via the Bluetooth function.

Voice focus: While enjoying music, you can pick up the sounds (such as announcements on the train) that you want to hear.

To deactivate the Ambient Sound Mode

Press the NC/AMBIENT button repeatedly until the Ambient Sound Mode is turned off.

Each time the button is pressed, the function switches as follows and is announced by the voice guidance.

The noise canceling function/Ambient Sound Mode: OFF



The noise canceling function: ON/Ambient Sound Mode: OFF



The Ambient Sound Mode: ON

Hint

- Depending on the ambient condition and the type/volume of audio playback, the ambient sound may not be heard even when using the Ambient Sound Mode. Do not use the headset in places where it would be dangerous if you are unable to hear ambient sounds such as on a road with car and bicycle traffic.
- If the headset is not worn properly, the Ambient Sound Mode may not work correctly. Wear the headset properly.
- You can also change the settings of the noise canceling function and the Ambient Sound Mode with the “Sony | Headphones Connect” app.
- Ambient Sound Mode settings changed with the “Sony | Headphones Connect” app are stored in the headset. You can enjoy music with the stored settings of the Ambient Sound Mode even when the headset is connected to other devices which do not have the “Sony | Headphones Connect” app installed.

Note

- Depending on the surrounding environment, wind noise may increase when the Ambient Sound Mode is turned on. In that case, cancel the voice focus with the "Sony | Headphones Connect" app. If the wind noise is still significant, turn off the Ambient Sound Mode.

Related Topic

- [About voice guidance](#)
- [Using the noise canceling function](#)
- [What you can do with "Sony | Headphones Connect" app](#)

4-740-049-11(2) Copyright 2018 Sony Corporation

Wireless Noise Canceling Stereo Headset
WH-1000XM3

Listening to ambient sound quickly (Quick Attention Mode)

This function turns down music, call sounds, and the ringtone to allow ambient sound to be easily heard. It is useful when you want to listen to train announcements, etc.

To activate the Quick Attention Mode

Touch the entire touch sensor control panel on the right unit. The Quick Attention Mode is activated only when you are touching the control panel.



A: Touch sensor control panel



If you touch as follows, the function may not work properly.



The whole touch sensor control panel is not covered.



The touch sensor control panel is not touched.

To deactivate the Quick Attention Mode

Release your hand from the touch sensor control panel.

Note

- Depending on the ambient condition and the type/volume of audio playback, the ambient sounds may not be heard even when using Quick Attention Mode. Do not use the headset in places where it would be dangerous if you are unable to hear ambient sounds such as on a road with car and bicycle traffic.
- If the headset is not worn properly, the Quick Attention Mode may not work correctly. Wear the headset properly.

Wireless Noise Canceling Stereo Headset
WH-1000XM3

About the sound quality mode

The following two sound quality modes can be selected during Bluetooth playback. You can switch the settings and check the sound quality mode with the "Sony | Headphones Connect" app.

Priority on sound quality: prioritizes the sound quality (default).

Priority on stable connection: prioritizes the stable connection.

- When using an AAC, aptX, aptX HD or LDAC compatible device, use with the "Priority on sound quality" mode.
- If the connection is unstable, such as when producing only intermittent sound, select the "Priority on stable connection" mode.

Note

- The playback time may shorten depending on the sound quality and the conditions under which you are using the headset.
- Depending on the ambient conditions in the area where you are using the headset, intermittent sound may still occur even if the "Priority on stable connection" mode is selected.

Related Topic

- [What you can do with "Sony | Headphones Connect" app](#)

Wireless Noise Canceling Stereo Headset
WH-1000XM3

Supported codecs

A codec is an audio coding algorithm used when transmitting sound via a Bluetooth connection.

The headset supports the following 5 codecs for music playback via an A2DP connection: SBC, AAC, aptX, aptX HD and LDAC.

- SBC

This is an abbreviation for Subband Codec.

This is the standard audio coding technology used by Bluetooth devices.

All Bluetooth devices support SBC.

- AAC

This is an abbreviation for Advanced Audio Coding.

AAC is mainly used by Apple products such as iPhones, and it provides higher sound quality than that of SBC.

- aptX

This is an audio coding technology. aptX is used by some Android smartphones, and it provides higher sound quality than that of SBC.

- aptX HD

This is an audio coding technology. aptX HD is used by some Android smartphones, and it provides higher sound quality than that of aptX.

- LDAC

LDAC is an audio coding technology developed by Sony that enables the transmission of High-Resolution (Hi-Res) Audio content, even over a Bluetooth connection.

Unlike other Bluetooth compatible coding technologies such as SBC, it operates without any down-conversion of the Hi-Res Audio content (*), and allows approximately three times more data (**), than those other technologies to be transmitted over a Bluetooth wireless network with unprecedented sound quality, employing efficient coding and optimized packetization.

* excluding DSD format contents

** in comparison with SBC when the bitrate of 990 kbps (96/48 kHz) or 909 kbps (88.2/44.1 kHz) is selected.

With the headset set to the "Priority on sound quality" mode, when music in one of the above codecs is transmitted from a connected device, the headset switches to that codec automatically and plays back the music in the same codec. However, depending on the device to be connected with the headset, you may need to set the device beforehand to listen to music in a different codec on the headset, even if the device supports a codec of higher sound quality than SBC. Refer to the operating instructions supplied with the device regarding setting the codec.

Related Topic

- [About the sound quality mode](#)

Wireless Noise Canceling Stereo Headset
WH-1000XM3

About the DSEE HX function

The DSEE HX function upscales the compressed sound source data such as CD or MP3 to quality almost that of High-Resolution Audio quality and reproduces the clear high-range sound that is often lost.

The DSEE HX function is available when you set as follows by using the "Sony | Headphones Connect" app.

DSEE HX	Connection	Codec	Sound Position Control Surround (VPT) Equalizer
AUTO	Bluetooth connection	SBC or AAC	All OFF

Related Topic

- [What you can do with "Sony | Headphones Connect" app](#)

Wireless Noise Canceling Stereo Headset
WH-1000XM3

Receiving a call

You can enjoy a hands-free call with a smartphone or mobile phone that supports the Bluetooth profile HFP (Hands-free Profile) or HSP (Headset Profile), via a Bluetooth connection.

- If your smartphone or mobile phone supports both HFP and HSP, set it to HFP.
- The operation may vary depending on the smartphone or mobile phone. Refer to the operating instructions supplied with your smartphone or mobile phone.
- The headset only supports normal incoming calls. Calling apps for smartphones and computers are not supported.

Ring tone

When an incoming call arrives, a ring tone will be heard from the headset, and the indicator (blue) flashes quickly. You will hear either of following ring tones, depending on your smartphone or mobile phone.

- Ring tone set on the headset
- Ring tone set on the smartphone or mobile phone
- Ring tone set on the smartphone or mobile phone only for a Bluetooth connection

1 Connect the headset to a smartphone or mobile phone beforehand.

2 When you hear a ring tone, double-tap the touch sensor control panel lightly (about 0.4-second interval) and receive the call.

When an incoming call arrives while you are listening to music, playback pauses and a ring tone will be heard from the headset.



If no ring tone is heard via the headset

- The headset may not be connected with the smartphone or mobile phone over HFP or HSP. Check the connection status on the smartphone or mobile phone.
- If playback does not pause automatically, operate the headset to pause playback.

3 Adjust the volume by operating the touch sensor control panel.

- To increase the volume: Swipe up repeatedly until the volume reaches the desired level.



- To decrease the volume: Swipe down repeatedly until the volume reaches the desired level.



- If you hold your finger to the touch sensor control panel after swiping up or down, the volume continues to change.

When the volume reaches the maximum or minimum, an alarm sounds.

4 To end the call, double-tap the touch sensor control panel lightly again.

If you received a call during music playback, music playback resumes automatically.

Hint

- Some smartphones or mobile phones receive calls with the phone instead of the headset by default. With an HFP or HSP connection, switch the call by placing your finger on the headset's touch sensor control panel until it switches or by using your smartphone or mobile phone.
- Volume for a call can be adjusted during a telephone conversation only.
- The headset volume during a call and during music playback can be independently adjusted. Changing the call volume does not change the volume of music playback and vice versa.

Note

- Depending on the smartphone or mobile phone, playback may not resume automatically even if you finish the call.
- Use a smartphone or mobile phone at least 50 cm away from the headset. Noise may result if the smartphone or mobile phone are too close to the headset.

Related Topic

- [How to make a wireless connection to Bluetooth devices](#)
- [Making a call](#)
- [Functions for a phone call](#)
- [What you can do with "Sony | Headphones Connect" app](#)

Making a call

You can enjoy a hands-free call with a smartphone or mobile phone that supports the Bluetooth profile HFP (Hands-free Profile) or HSP (Headset Profile), via a Bluetooth connection.

- If your smartphone or mobile phone supports both HFP and HSP, set it to HFP.
- The operation may vary depending on the smartphone or mobile phone. Refer to the operating instructions supplied with your smartphone or mobile phone.
- The headset only supports normal incoming calls. Calling apps for smartphones and computers are not supported.

1 Connect the headset to a smartphone or mobile phone beforehand.

2 Operate your smartphone or mobile phone to make a call.

When you make a call, the dial tone is heard from the headset.

If you make a call while you are listening to music, playback pauses.

If no dial tone is heard via the headset, switch the call device to the headset using your smartphone or mobile phone or by holding your finger to the touch sensor control panel until the device is switched.



3 Adjust the volume by operating the touch sensor control panel.

- To increase the volume: Swipe up repeatedly until the volume reaches the desired level.



- To decrease the volume: Swipe down repeatedly until the volume reaches the desired level.



- If you hold your finger to the touch sensor control panel after swiping up or down, the volume continues to change.

When the volume reaches the maximum or minimum, an alarm sounds.

4 To end the call, double-tap the touch sensor control panel.

If you made a call during music playback, music playback resumes automatically after ending the call.

Hint

- Volume for a call can be adjusted during a telephone conversation only.
- The headset volume during a call and during music playback can be independently adjusted. Changing the call volume does not change the volume of music playback and vice versa.

Note

- Use a smartphone or mobile phone at least 50 cm away from the headset. Noise may result if the smartphone or mobile phone is too close to the headset.

Related Topic

- [How to make a wireless connection to Bluetooth devices](#)
- [Receiving a call](#)
- [Functions for a phone call](#)

Wireless Noise Canceling Stereo Headset
WH-1000XM3

Functions for a phone call

The functions available during a call may vary depending on the profile supported by your smartphone or mobile phone. In addition, even if the profile is the same, the functions may vary depending on the smartphone or mobile phone. Refer to the operating instructions supplied with your smartphone or mobile phone.

Supported profile: HFP (Hands-free Profile)

During standby/music playback

- Hold your finger to the touch sensor control panel to start the voice dial function of the smartphone/mobile phone (*) or activate the Google app on an Android smartphone or Siri on an iPhone.

Outgoing call

- Double-tap the touch sensor control panel lightly (about 0.4-second interval) to cancel an outgoing call.

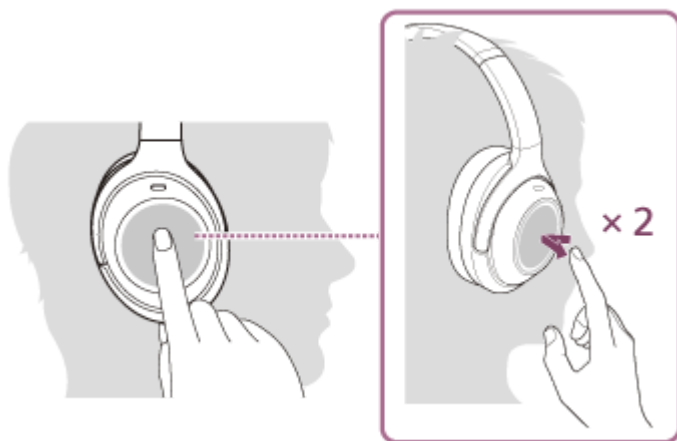

- Hold your finger to the touch sensor control panel until the call device is switched between the headset and the smartphone or mobile phone.



Incoming call

- Double-tap the touch sensor control panel lightly to answer a call.
- Hold your finger to the touch sensor control panel to reject a call.

During call

- Double-tap the touch sensor control panel lightly to finish a call.
- Hold your finger to the touch sensor control panel until the call device is switched between the headset and the smartphone or mobile phone.

Supported profile: HSP (Headset Profile)

Outgoing call

- Double-tap the touch sensor control panel to cancel an outgoing call. (*)

Incoming call

- Double-tap the touch sensor control panel lightly to answer a call.

During call

- Double-tap the touch sensor control panel lightly to finish a call. (*)

* Some devices may not support this function.

Related Topic

- [Receiving a call](#)
- [Making a call](#)

4-740-049-11(2) Copyright 2018 Sony Corporation

Wireless Noise Canceling Stereo Headset
WH-1000XM3

Disconnecting Bluetooth connection (after use)

- 1 Touch the one-touch connection (NFC) compatible device once more to disconnect it. (Unlock the screen of the device if it is locked.) If the Bluetooth device does not support one-touch connection (NFC), operate from the device to disconnect.**

When disconnected, you will hear a voice guidance "Bluetooth disconnected".

- 2 Turn off the headset.**

You will hear a voice guidance "Power off".

Hint

- When you finish playing music, the Bluetooth connection may terminate automatically depending on the Bluetooth device.

Related Topic

- [Disconnecting the Android smartphone with one-touch \(NFC\)](#)
- [Turning off the headset](#)

Wireless Noise Canceling Stereo Headset
WH-1000XM3

Using the Google Assistant

By using the Google Assistant feature that comes with the smartphone, you can speak to the headset to operate the smartphone or perform the search.

Compatible smartphones

- Smartphones installed with Android 5.0 or later (Google app 7.0 or later is required.)
- iPhone/iPod touch (Installation of the Google Assistant application is required.)

1 If your smartphone is an iPhone/iPod touch, open the Google Assistant app.

If your smartphone is an Android smartphone, skip this step.

2 Open the "Sony | Headphones Connect" app, and set the NC/AMBIENT button as the Google Assistant button.

When using the Google Assistant for the first time, open the Google Assistant app and tap the [Finish headphones setup] button on the Conversation View, and follow the on-screen instructions to complete initial settings for the Google Assistant.

For details of the "Sony | Headphones Connect" app, refer to the following URL.

http://rd1.sony.net/help/mdr/hpc/h_zz/

3 Press the NC/AMBIENT button to use the Google Assistant.

- Press and hold to input a voice command.
- Press once to read out the notification.
- Press twice to cancel the voice command.

For details of the Google Assistant, refer to the following website:

<https://assistant.google.com>

<https://g.co/headphones/help>

Hint

- Check or update the software version of the headset with the "Sony | Headphones Connect" app.
- When the Google Assistant is not available for reasons such as not being connected to the network, a voice guidance "The Google Assistant is not connected" is heard.
- If you do not see the [Finish headphones setup] button on the Google Assistant app, please unpair the headphones from the Bluetooth settings of your smartphone and redo the pairing process.

Note

- If the NC/AMBIENT button is set as the Google Assistant button in step 2, the noise canceling function or the NC Optimizer function cannot be operated from the headset.
- The Google Assistant may not be used in some countries, regions, or languages.



Using the voice assist function (Google app)

By using the Google app feature that comes with the Android smartphone, you can speak to the headset to operate the Android smartphone.

1 Set assistant and voice input settings on the Google app.

On the Android smartphone, select [Settings] - [Apps], then select the gear icon appeared in the top-right corner of the display.

Then, select [Assist & voice input] - [Assist app], and then set [Assist app] to the Google app.

The above procedure is an example. For details, refer to the operating instructions of the Android smartphone.

Note: The latest version of the app may be required.

For details on the Google app, refer to the operating instructions or the support website of the Android smartphone, or the Google Play store website.

The Google app may not be activated from the headset depending on specifications of the Android smartphone.

2 Connect the headset to the Android smartphone via Bluetooth connection.

3 When the Android smartphone is in standby or playing music, hold your finger to the touch sensor control panel to activate the Google app.

The Google app is activated.

4 Make a request to the Google app through the headset.

For details on the Google app, such as apps which work with the Google app, refer to the operating instructions of the Android smartphone.

After activating the Google app, when a certain time has passed without requests, the Google app will be deactivated.

Note

- If the NC/AMBIENT button is set as the Google Assistant button, the voice assist function (Google app) is not available.
- The Google app cannot be activated when you say "Ok Google" even when the Android smartphone's "Ok Google" setting is on.

Using the voice assist function (Siri)

By using the Siri feature that comes with iPhone, you can speak to the headset to operate the iPhone.

1 Turn Siri on.

On iPhone, select [Settings] - [Siri & Search] to turn [Press Home for Siri] and [Allow Siri When Locked] on. The operation above is an example. For details, refer to the operating instructions of the iPhone.

Note: For details on Siri, refer to the operating instructions or support website of the iPhone.

2 Connect the headset to the iPhone via Bluetooth connection.

3 When the iPhone is using the Bluetooth connection and in standby or playing music, hold your finger to the touch sensor control panel to activate Siri.

Siri is activated.

4 Make a request to the Siri through the headset.

For details on Siri, such as apps which work with Siri, refer to the operating instructions of the iPhone.

5 To continue to request, double-tap the touch sensor control panel lightly before Siri is deactivated.

After activating Siri, when a certain time has passed without requests, Siri will be deactivated.

Note

- Siri cannot be activated when you say "Hey Siri" even when the iPhone's "Hey Siri" setting is on.

Wireless Noise Canceling Stereo Headset
WH-1000XM3

What you can do with "Sony | Headphones Connect" app

When you connect the smartphone (with the "Sony | Headphones Connect" app installed) and the headset via the Bluetooth function, you can do the following.

- Easy pairing
- Display the remaining battery life of the headset
- Display the Bluetooth connection codec
- Adjust the noise canceling function and Ambient Sound Mode (ambient sound control)
- Use auto adjustment of the noise canceling function by behavior recognition (Adaptive Sound Control)
- NC Optimizer (Optimizing the noise canceling function)
- Change the sound localization
- Select the sound effect mode (Surround (VPT))
- Select the Equalizer setting
- Customize the Equalizer setting
- Switch the sound quality mode by setting the Bluetooth connection mode
- Set the DSEE HX (completion for high-range sound) function
- Change the function of the NC/AMBIENT button (the Google Assistant)
- Auto power off setting
- Adjust volume
- Play music/ pause, fast-reverse/ fast-forward
- Check the connection status and the settings of the headset
- Check the headset software version
- Headset software update

For details of the "Sony | Headphones Connect" app, refer to the following URL.

http://rd1.sony.net/help/mdr/hpc/h_zz/

Hint

- The operation of the "Sony | Headphones Connect" app depends on the audio device. The app specifications and screen design may change without prior notice.

Related Topic

- [Installing "Sony | Headphones Connect" app](#)
- [Checking the remaining battery charge](#)
- [Using the noise canceling function](#)
- [Optimizing the noise canceling function to suit the wearer \(NC Optimizer\)](#)
- [Listening to ambient sound during music playback \(Ambient Sound Mode\)](#)
- [About the sound quality mode](#)
- [Supported codecs](#)
- [About the DSEE HX function](#)

Wireless Noise Canceling Stereo Headset
WH-1000XM3

Installing "Sony | Headphones Connect" app

- 1** Download the "Sony | Headphones Connect" app from Google Play store or App Store, and install the app on your smartphone.

For details of the "Sony | Headphones Connect" app, refer to the following URL.

http://rd1.sony.net/help/mdr/hpc/h_zz/



Sony Headphones Connect 

- 2** After installing the app, launch the "Sony | Headphones Connect" app.
-

Related Topic

- [What you can do with "Sony | Headphones Connect" app](#)

Precautions

On Bluetooth communications

- Bluetooth wireless technology operates within a range of about 10 m (30 feet). The maximum communication distance may vary depending on the presence of obstacles (people, metal objects, walls, etc.) or the electromagnetic environment.
- Microwaves emitting from a Bluetooth device may affect the operation of electronic medical devices. Turn off this unit and other Bluetooth devices in the following locations, as it may cause an accident:
 - in hospitals, near priority seating in trains, locations where inflammable gas is present, near automatic doors, or near fire alarms.
- This product emits radio waves when used in wireless mode. When used in wireless mode on an airplane, follow flight crew directions regarding permissible use of products in wireless mode.
- The audio playback on this unit may be delayed from that on the transmitting device, due to the characteristics of Bluetooth wireless technology. As a result, the sound may not be in sync with the image when viewing movies or playing games.
- The unit supports security functions that comply with the Bluetooth standard as a means of ensuring security during communication using Bluetooth wireless technology. However, depending on the configured settings and other factors, this security may not be sufficient. Be careful when communicating using Bluetooth wireless technology.
- Sony shall assume no responsibility for any damages or loss resulting from information leaks that occur when using Bluetooth communications.
- Connection with all Bluetooth devices cannot be guaranteed.
 - Bluetooth devices connected with the unit must comply with the Bluetooth standard prescribed by Bluetooth SIG, Inc., and must be certified as compliant.
 - Even when a connected device complies with the Bluetooth standard, there may be cases where the characteristics or specifications of the Bluetooth device make it unable to connect, or result in different control methods, display, or operation.
 - When using the unit to perform hands-free talking on the phone, noise may occur depending on the connected device or the communication environment.
- Depending on the device to be connected, it may require some time to start communications.

Note on static electricity

- Static electricity accumulated in the body may cause mild tingling in your ears. To reduce the effect, wear clothes made from natural materials, which suppress the generation of static electricity.

Notes on wearing the unit

- Because the headphones achieve a tight seal over the ears, forcibly pressing them against your ears or quickly pulling them off can result in eardrum damage.
Pressing the headphones against your ears may cause the speaker diaphragm to produce a click sound. This is not a malfunction.

Others

- Do not subject the unit to excessive shock.
- The touch sensor may not operate properly if you apply stickers or other adhesive items to the touch sensor control panel.
- Be careful not to catch your finger in the unit when folding.
- When you use the unit as wired headphones, use the supplied headphone cable only. Make sure that the headphone cable is firmly inserted.

- The Bluetooth function may not work with a mobile phone, depending on the signal conditions and the surrounding environment.
- Do not apply weight or pressure to the unit for long periods, including when it is stored, as it may cause deformation.
- If you experience discomfort while using the unit, stop using it immediately.
- The earpads may be damaged or deteriorate with long-term use and storage.

Cleaning the unit

- When the outside of the unit is dirty, clean it by wiping with a soft dry cloth. If the unit is particularly dirty, soak a cloth in a dilute solution of neutral detergent, and wring it well before wiping. Do not use solvents such as thinner, benzene, or alcohol, as they may damage the surface.

Do not use the headset close to the medical devices

- This product has magnets which may interfere with pacemakers, defibrillators and programmable shunt valves or other medical devices. Do not put this product close to these medical devices and the person who use any of these medical devices. Consult your doctor before using this product, if you have any concerns.

Do not place cards with magnets in the vicinity of the headset.

- This product has magnets. Placing cards with magnets in the vicinity of the product may affect the magnetism of the card and render it unusable.

Wireless Noise Canceling Stereo Headset
WH-1000XM3

Trademarks

- Windows is a registered trademark or trademark of Microsoft Corporation in the United States and/or other countries.
- iPhone, iPod, iPod touch, macOS and Mac are trademarks of Apple Inc., registered in the U.S. and other countries.
- App Store is a service mark of Apple Inc., registered in the U.S. and other countries.
- iOS is a trademark or registered trademark of Cisco in the U.S. and other countries and is used under license.
- Google and Android are trademarks of Google LLC.
- The Bluetooth® word mark and logos are registered trademarks owned by the Bluetooth SIG, Inc. and any use of such marks by Sony Corporation is under license.
- The N-Mark is a trademark or registered trademark of NFC Forum, Inc. in the United States and in other countries.
- Qualcomm aptX is a product of Qualcomm Technologies International, Ltd.
Qualcomm is a trademark of Qualcomm Incorporated, registered in the United States and other countries, used with permission. aptX is a trademark of Qualcomm Technologies International, Ltd., registered in the United States and other countries, used with permission.
- The LDAC name and logo are trademarks of Sony Corporation.
- USB Type-C™ and USB-C™ are trademarks of USB Implementers Forum.
- “DSEE” and “DSEE HX” are trademarks of Sony Corporation.

Other trademarks and trade names are those of their respective owners.

Wireless Noise Canceling Stereo Headset
WH-1000XM3

Customer support websites

For customers in the U.S.A:

<http://esupport.sony.com/>

For customers in Canada:

<http://esupport.sony.com/CA/>

For customers in Latin America:

<http://esupport.sony.com/LA/>

For customers in European countries:

<https://www.sony.eu/support/>

For customers in China:

<https://service.sony.com.cn/>

For customers in other countries/regions:

<http://www.sony-asia.com/>

Wireless Noise Canceling Stereo Headset
WH-1000XM3

What can I do to solve a problem?

If the headset does not function as expected, try the following steps to resolve the issue.

- Find the symptoms of the issue in this Help Guide, and try any corrective actions listed.
- Charge the headset.
You may be able to resolve some issues by charging the headset battery.
- Reset the headset.
- Initialize the headset.
This operation resets volume settings, etc., and deletes all pairing information.
- Look up information on the issue on the customer support website.

If the operations above do not work, consult your nearest Sony dealer.

Related Topic

- [Charging the headset](#)
- [Customer support websites](#)
- [Resetting the headset](#)
- [Initializing the headset to restore factory settings](#)

Wireless Noise Canceling Stereo Headset
WH-1000XM3

The headset is not turned on.

- Make sure the battery is charged enough to turn the headset on.
 - The headset cannot be turned on while charging the battery. Remove the USB Type-C cable and turn on the headset.
-
-

Related Topic

- [Charging the headset](#)
- [Checking the remaining battery charge](#)

Wireless Noise Canceling Stereo Headset
WH-1000XM3

Charging cannot be done.

- Be sure to use the supplied USB Type-C cable.
 - Check that the USB Type-C cable is firmly connected to the headset and the USB AC adapter or computer.
 - Make sure that the USB AC adaptor is firmly connected to the AC outlet.
 - Check that the computer is turned on.
 - Check that the computer is not in standby, sleep or hibernation mode.
 - When using Windows 8.1, update using Windows Update.
-

Related Topic

- [Charging the headset](#)

Wireless Noise Canceling Stereo Headset
WH-1000XM3

Charging time is too long.

- Check that the headset and the computer are directly connected, not via a USB hub.
 - Check that you are using a commercially available USB AC adapter capable of supplying an output current of 1.5 A or more.
 - Check that you are using the supplied USB Type-C cable.
-
-

Related Topic

- [Charging the headset](#)

Wireless Noise Canceling Stereo Headset
WH-1000XM3

The headset cannot be recognized by a computer.

- Check that the USB Type-C cable is properly connected to the USB port of the computer.
- Check that the headset and the computer are directly connected, not via a USB hub.
- There may be a problem with the USB port of the connected computer. Try connecting to another USB port on the computer if one is available.
- Try the USB connection procedure again in cases other than those stated above.

Wireless Noise Canceling Stereo Headset
WH-1000XM3

The remaining battery charge of the headset is not displayed on the screen of an iPhone or iPod touch.

- The remaining battery charge is shown only on the screen of an iPhone or iPod touch (iOS 5.0 or later) that supports HFP (Hands-free Profile).
- Check that the iPhone or iPod touch is connected with HFP (Hands-free Profile). Otherwise, the remaining battery charge will not be correctly displayed.

Related Topic

- [Checking the remaining battery charge](#)

Wireless Noise Canceling Stereo Headset
WH-1000XM3

No sound

- Check that both the headset and the connected device (i.e., smartphone) are turned on.
 - Check that the headset and the transmitting Bluetooth device are connected via Bluetooth A2DP.
 - Turn up the volume if it is too low.
 - Check that the connected device is playing back.
 - If you are connecting a computer to the headset, make sure the audio output setting of the computer is set for a Bluetooth device.
 - Pair the headset and the Bluetooth device again.
 - Check that the headphone cable is connected firmly.
-

Related Topic

- [How to make a wireless connection to Bluetooth devices](#)
- [Using the supplied headphone cable](#)
- [Listening to music from a device via Bluetooth connection](#)

Wireless Noise Canceling Stereo Headset
WH-1000XM3

Low sound level

- Turn up the volume of the headset and the connected device.
- Connect the Bluetooth device to the headset once again.

4-740-049-11(2) Copyright 2018 Sony Corporation

Low sound quality

- Turn down the volume of the connected device if it is too loud.
- Keep the headset away from microwave ovens, Wi-Fi devices, etc.
- Bring the headset closer to the Bluetooth device. Remove any obstacles between the headset and the Bluetooth device.
- Keep the headset away from a TV.
- Switch the Bluetooth connection to A2DP by operating the Bluetooth device when HFP or HSP is set.
- If you connect a device with a built-in radio or tuner to the headset, broadcasts may not be received or the sensitivity may be reduced. Move the headset away from the connected device and try again.
- If you have previously connected the headset to this Bluetooth device, only an HFP/HSP Bluetooth connection may be established when the headset is turned on. Use the Bluetooth device to connect via an A2DP Bluetooth connection.
- When listening to music from a computer on the headset, the sound quality may be poor (e.g., difficult to hear the singer's voice, etc.) for the first few seconds after a connection is established.
This is due to the computer specifications (prioritizes communication at the start of transmission and then switches to prioritizing audio quality several seconds later) and is not a headset malfunction. If the sound quality does not improve after a few seconds, lightly double-tap the touch sensor control panel of the headset (about 0.4-second intervals). Or you can use the computer to establish an A2DP connection. For the operations on your computer, refer to the operating instructions supplied with your computer.

Wireless Noise Canceling Stereo Headset
WH-1000XM3

Sound skips frequently.

- Set the headset to “Priority on stable connection” mode. For details, see “[About the sound quality mode](#)”.
- Remove any obstacles between the antenna of the connecting Bluetooth device and the built-in antenna of the headset. The antenna of the headset is built into the part shown in the dotted line below.



A: Location of the built-in antenna

- Bluetooth communications may be disabled, or noise or audio dropout may occur under the following conditions.
 - When there is a human body between the headset and the Bluetooth device
Put the Bluetooth device in the same direction as the antenna of the headset to improve the Bluetooth communications.
 - There is an obstacle, such as metal or a wall, between the headset and the Bluetooth device.
 - In places with wireless LAN, where a microwave oven is used, electromagnetic waves are generated, etc.
- The situation may be improved by changing the wireless playback quality settings or fixing the wireless playback mode to SBC on the transmitting device. For details, refer to the operating instructions supplied with the transmitting device.
- Because Bluetooth devices and Wi-Fi (IEEE802.11b/g/n) use the same frequency (2.4 GHz), microwave interference may occur and result in noise, audio dropouts, or communications being disabled if this headset is used near a Wi-Fi device. In such a case, perform the following steps.
 - Use this headset at least 10 m (30 feet) away from the Wi-Fi device.
 - If this headset is used within 10 m (30 feet) of a Wi-Fi device, turn off the Wi-Fi device.
 - Use this headset and the Bluetooth device as near to each other as possible.
- If you are enjoying music with your smartphone, the situation may be improved by shutting down unnecessary apps or restarting your smartphone.

Wireless Noise Canceling Stereo Headset
WH-1000XM3

The noise canceling effect is not sufficient.

- Make sure that the noise canceling function is turned on.
 - Adjust the earpad position to fit your ears.
 - The noise canceling function is effective in low frequency ranges such as airplanes, trains, offices, near air-conditioning, and is not as effective for higher frequencies, such as human voices.
-
-

Related Topic

- [What is noise canceling?](#)
- [Using the noise canceling function](#)

Wireless Noise Canceling Stereo Headset
WH-1000XM3

Pairing cannot be done.

- Bring the headset and the Bluetooth device within 1 m (3 feet) from each other.
 - The headset automatically enters pairing mode when pairing the first device after purchasing, initializing, or repairing the headset. To pair a 2nd or subsequent device, press and hold the  button of the headset for 7 seconds or more to enter pairing mode.
 - When pairing a device once again after initializing or repairing the headset, you may be unable to pair the device if it retains pairing information for the headset (iPhone or other device). In this case, delete the pairing information for the headset from the device and pair them again.
-

Related Topic

- [About the indicator](#)
- [How to make a wireless connection to Bluetooth devices](#)
- [Initializing the headset to restore factory settings](#)

Wireless Noise Canceling Stereo Headset
WH-1000XM3

One-touch connection (NFC) does not work.

- Keep the smartphone close to the N-mark on the headset until the smartphone responds. If it still does not respond, slowly move the smartphone in all directions.
 - Check that the NFC function of the smartphone is set to On.
 - If the smartphone is in a case, remove it.
 - NFC reception sensitivity varies depending on the smartphone. If the connection repeatedly fails, connect/disconnect by operating the smartphone.
 - You cannot establish a one-touch connection (NFC) while charging the battery, because the headset cannot be turned on. Finish charging before establishing the one-touch connection (NFC).
 - You cannot establish a one-touch connection (NFC) when the headphone cable is connected to the INPUT jack. Remove the headphone cable before establishing the one-touch connection (NFC).
 - Check that the connecting device supports the NFC function.
 - Check that the Bluetooth function of the smartphone is turned on.
-

Related Topic

- [One-touch connection \(NFC\) with an Android smartphone \(Android 4.1 or later\)](#)

Wireless Noise Canceling Stereo Headset
WH-1000XM3

Unable to make a Bluetooth connection.

- Check that the headset is turned on.
 - Check that the Bluetooth device is turned on and the Bluetooth function is on.
 - If the headset automatically connects to the last connected Bluetooth device, you may fail to connect the headset to other devices via the Bluetooth function. In that case, operate the last connected Bluetooth device and disconnect the Bluetooth connection.
 - The Bluetooth device is in sleep mode. Cancel the sleep mode.
 - The Bluetooth connection is terminated. Make the Bluetooth connection again.
 - In case that the pairing information for the headset has been deleted on the connected device, pair the headset with the device again.
-

Related Topic

- [About the indicator](#)
- [How to make a wireless connection to Bluetooth devices](#)

Wireless Noise Canceling Stereo Headset
WH-1000XM3

Distorted sound

- Keep the headset away from a microwave oven, Wi-Fi device, etc.

4-740-049-11(2) Copyright 2018 Sony Corporation

Wireless Noise Canceling Stereo Headset
WH-1000XM3

The Bluetooth wireless communication range is short, or the sound skips.

- Set the headset to “Priority on stable connection” mode. For details, see “[About the sound quality mode](#)”.
- Remove any obstacles between the antenna of the connecting Bluetooth device and the built-in antenna of the headset. The antenna of the headset is built into the part shown in the dotted line below.



A: Location of the built-in antenna

- Bluetooth communications may be disabled, or noise or audio dropout may occur under the following conditions.
 - When there is a human body between the headset and the Bluetooth device
Put the Bluetooth device in the same direction as the antenna of the headset to improve the Bluetooth communications.
 - There is an obstacle, such as metal or a wall, between the headset and the Bluetooth device.
 - In places with wireless LAN, where a microwave oven is used, electromagnetic waves are generated, etc.
- The situation may be improved by changing the wireless playback quality settings or fixing the wireless playback mode to SBC on the transmitting device. For details, refer to the operating instructions supplied with the transmitting device.
- Because Bluetooth devices and Wi-Fi (IEEE802.11b/g/n) use the same frequency (2.4 GHz), microwave interference may occur and result in noise, audio dropouts, or communications being disabled if this headset is used near a Wi-Fi device. In such a case, perform the following steps.
 - Use this headset at least 10 m (30 feet) away from the Wi-Fi device.
 - If this headset is used within 10 m (30 feet) of a Wi-Fi device, turn off the Wi-Fi device.
 - Use this headset and the Bluetooth device as near to each other as possible.
- If you are listening to music with your smartphone, the situation may be improved by shutting down unnecessary apps or restarting your smartphone.

Wireless Noise Canceling Stereo Headset
WH-1000XM3

The headset does not operate properly.

- Reset the headset. This operation does not delete pairing information.
 - If the headset does not operate properly even after resetting it, initialize the headset.
-
-

Related Topic

- [Resetting the headset](#)
- [Initializing the headset to restore factory settings](#)

Wireless Noise Canceling Stereo Headset
WH-1000XM3

Cannot hear a person on a call.

- Check that both the headset and the connected device (i.e., smartphone) are turned on.
 - Turn up the volume of the connected device and the volume of the headset if they are too low.
 - Check the audio settings of the Bluetooth device to make sure the sound comes from the headset during a call.
 - Use the Bluetooth device to reestablish the connection. Select HFP or HSP for the profile.
 - While listening to music with the headset, stop playback and double-tap the touch sensor control panel lightly to respond to an incoming call.
-

Related Topic

- [How to make a wireless connection to Bluetooth devices](#)
- [Receiving a call](#)
- [Making a call](#)

Wireless Noise Canceling Stereo Headset
WH-1000XM3

Low voice from callers

- Turn up the volume of the headset and the connected device.

4-740-049-11(2) Copyright 2018 Sony Corporation

Wireless Noise Canceling Stereo Headset
WH-1000XM3

Resetting the headset

If the headset cannot be turned on or cannot be operated even when it is turned on, press the  button and the NC/AMBIENT button simultaneously while charging. The headset will be reset. The device registration (pairing) information is not deleted.

To charge the headset after resetting, disconnect and reconnect the USB Type-C cable.

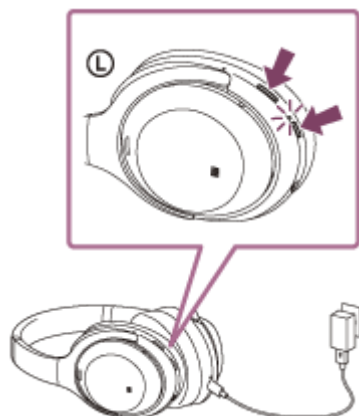

If the headset does not operate correctly even after resetting, initialize the headset to restore factory settings.

Related Topic

- [Initializing the headset to restore factory settings](#)

Wireless Noise Canceling Stereo Headset
WH-1000XM3

Initializing the headset to restore factory settings

Turn off the headset while the USB Type-C cable is disconnected and then press and hold the  button and the NC/AMBIENT button simultaneously for 7 seconds or more.

The blue indicator flashes four times (● ● ● ●), and the headset is initialized. This operation resets volume settings, etc., and deletes all pairing information. In this case, delete the pairing information for the headset from the device and then pair them again.

If the headset does not operate correctly even after initializing, consult your nearest Sony dealer.