

# Thermal Receipt Printer

## Quick Start Guide

## OUTLOOK AND INSTALL PAPER ROLL

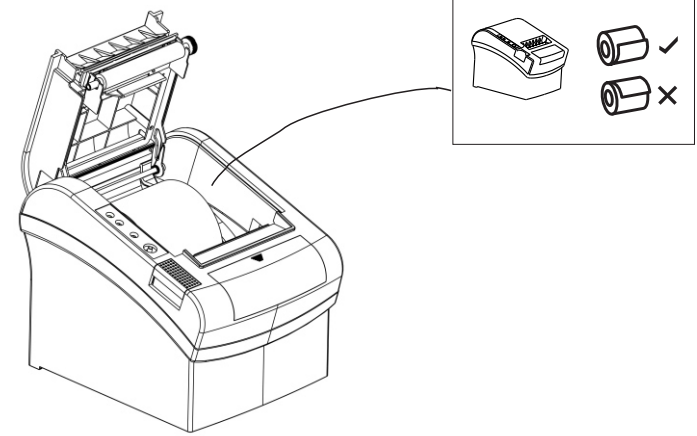
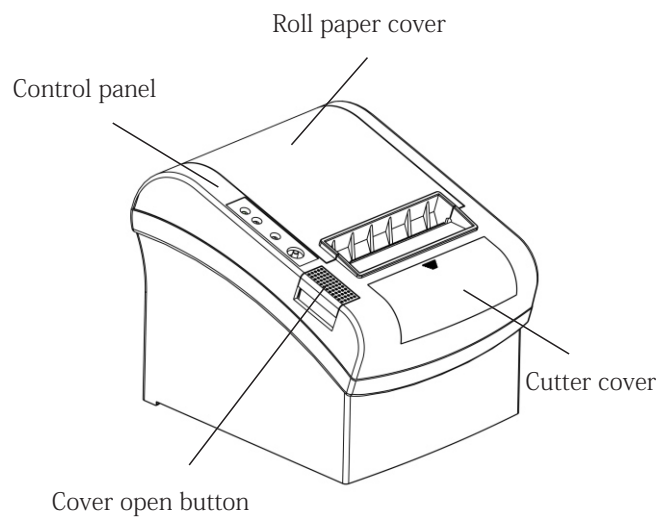
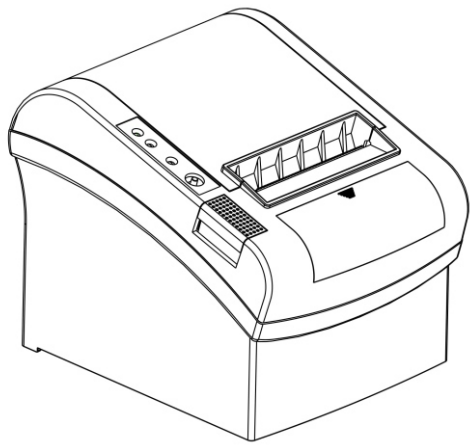

Remove the used roll paper core if any, and insert the roll paper. The correct direction of the paper is shown in the illustration below.

## STEP 1 - INSTALL PRINTER

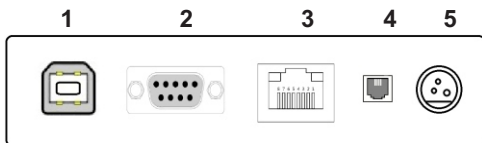

- 1) USB Port
- 2) Serial Port
- 3) LAN Port
- 4) Cash Drawer Port Rj11
- 5) Power Port

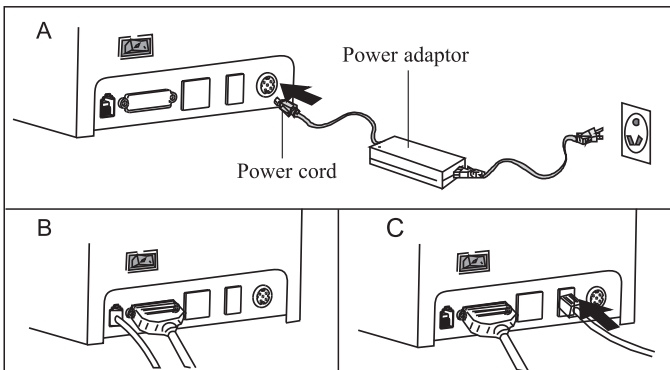

- A. Connect AC power cord to power, DC power cord to printer.
- B. Connect printer and computer/ tablet.
- C. Connect cash drawer.

Button name, indicator LED light and function

- 1. Feed Button:**  
Press to feed paper manually.
- 2. Paper Indicator (LED Light):**  
Blue and red lights are on means lack of paper, no alarm means all goes well.
- 3. Power Indicator:**  
Light is on means connected properly.
- 4. Error Indicator:**  
When out of paper, cutter or printing head overheat occurred, the ALARM indicator twinkles.

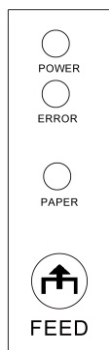

### Self Test

Method: When the printer is connect power off, press "FEED" button and turn on at the same time, 2 seconds later release "FEED" button, a completed self test will be printed out to show printer settings.

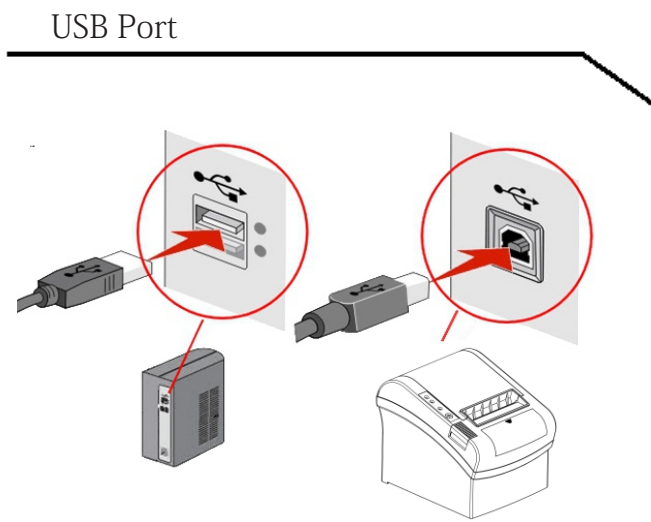

### CHANGE PRINTER IP

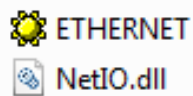

- 1) Double click " ETHERNET "

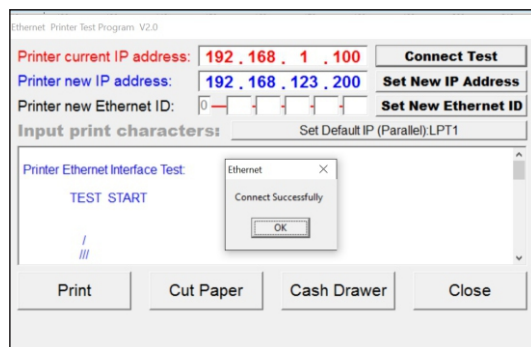

- 2) Write down Printer IP in Red Colour and display "Connect Successfully".  
Printer IP can be found after "Self Test".
- 3) Setting new printer IP in Blue Colour.
- 4) Click "Set New IP Address", after that heard "bee bee" and display "New IP address updated Successfully".

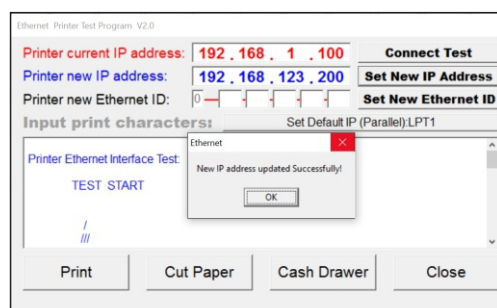

- 5) Click "OK" and "Close".
- 6) Finish.

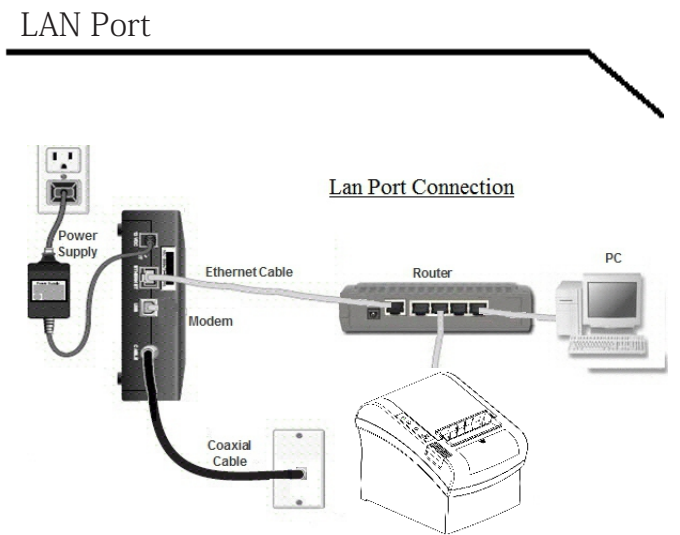

### Add IP PORT FOR DRIVER

- (1) Set computer IP to 192.168.123.xxx.
- (2) Right key receipt printer in Control Panel and choose "Printer properties"
- (3) Click "Ports" and choose "Add Ports..."
- (4) Click "Standard TCP/IP Port" and "New Port..."

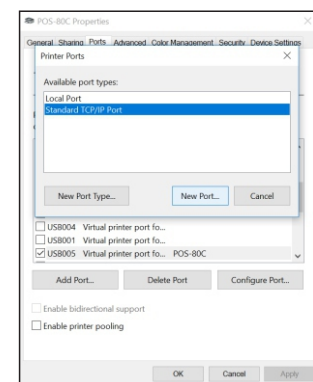

- (5) Click "Next" until this. "Printer Name or IP Address" write down receipt printer IP.

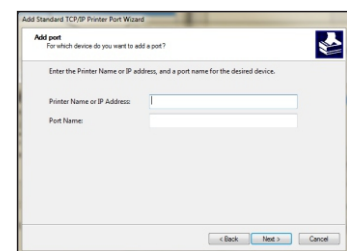

- (6) Click "Next" until "Finish". Then click "Close".

### CASH DRAWER PORT (Rj11 CABLE)

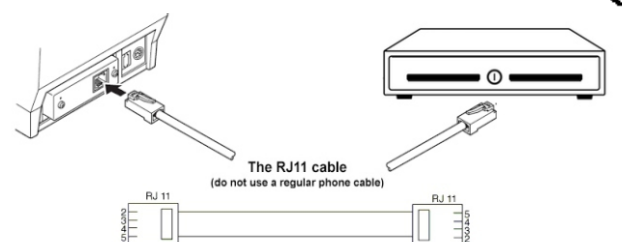

# STEP 2 - INSTALL DRIVER

1) Install driver under WINDOWS OS (Steps as below).

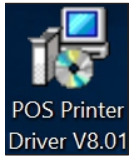

1. Double click driver.



2. Select: Next.

3. Default installation folder.

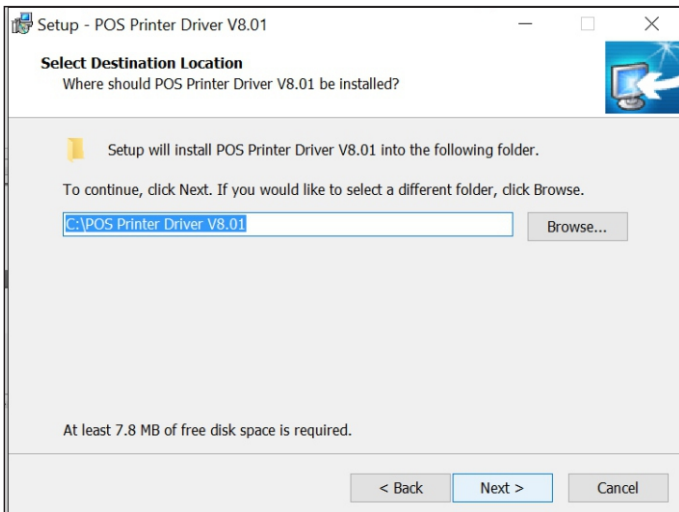

4. Create a shortcut on the desktop.

5. Install by below instruction.

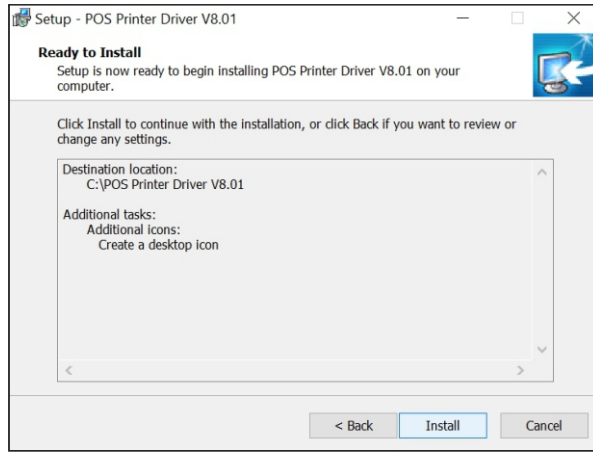

6. Finished.



7. Choose the right port, shown as below:

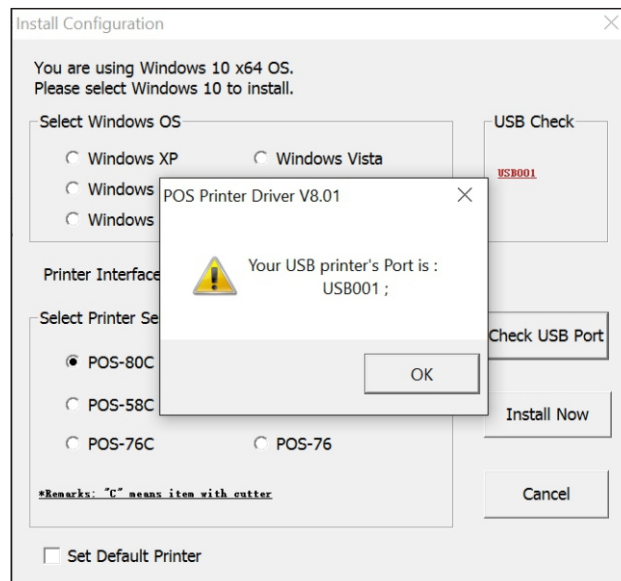

8. Choose the right series, shown as below.

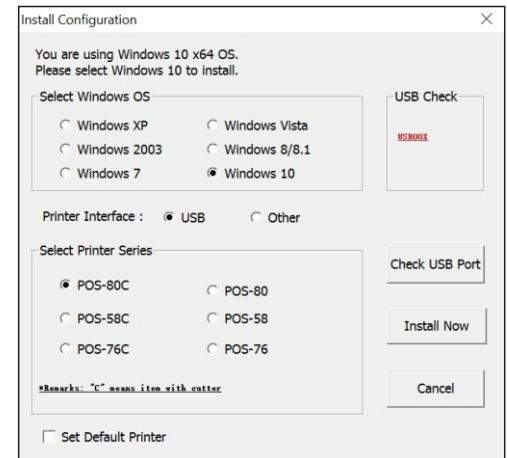

9. Click "OK" to configure the port.

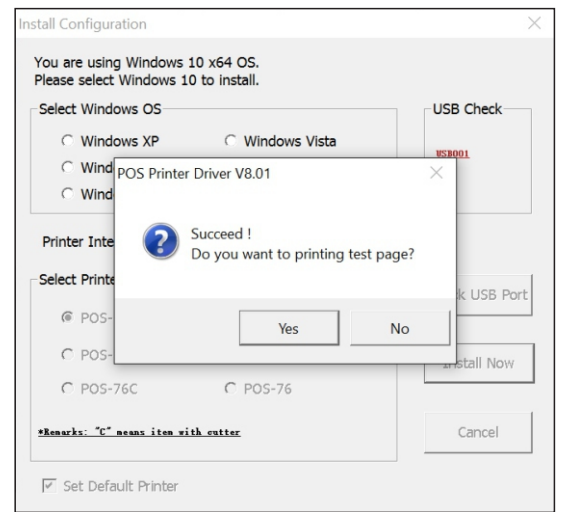

10. Choose the detect USB001.click apply, shown as below.

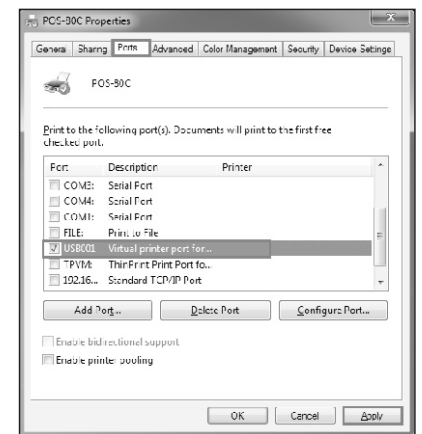

11. Finish.

## SETTING PRINTING MODE

### Setting printing Mode (DIP Switches)

DIP switches can be changed setting, such as: cutter, languages, beeper, print density baud rate etc.

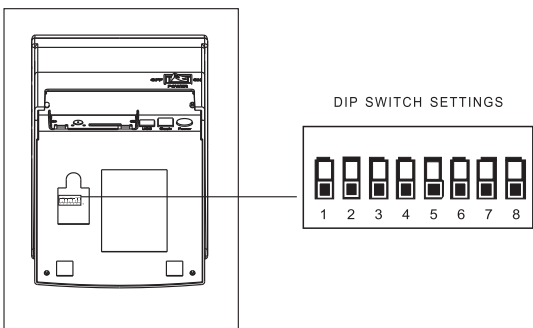

#### DIP Switch functions

DIP Function				
No.	Function	ON	OFF	
SW-1	Select cutter	NO	YES	
SW-2	Select beeper	YES	NO	
SW-3	Cutter with alarm	YES	NO	
SW-4	Two-byte character code	NO	YES	
SW-5	Character per line	42	48	
SW-6	Virtual Com to USB	YES	NO	
SW-7		ON	OFF	ON
SW-8		ON	ON	OFF
Transmission speed (bps) - bit/s	38400	115200	9600	19200

## CUTTER STUCK MAINTENANCE

### Cutter stuck maintenance

#### Method (1)

Turn off the power and then restart.

#### Method (2)

Turn the gear on printing head, cutter can be returned to its original position.

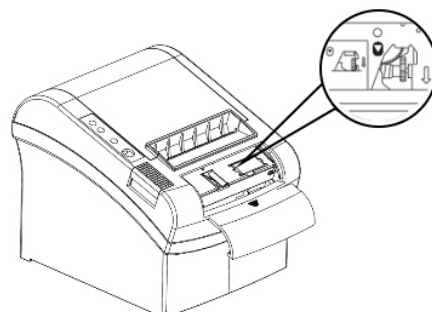
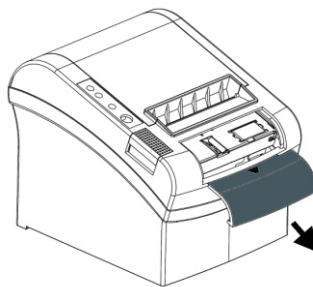

**Notice:** To avoid the damage of the printing head and automatic paper cutter, please do not open cutter and mechanism violently.

## CLEARANCE AND MAINTENANCE

### Clearance

One of the following occurred, please clean printing head.

- (1) Printing is not clear.
- (2) Any vertical is not clear.
- (3) Paper feed noisily.

#### Printing head cleaning steps:

- (1) Turn printer off, release power cord. Open top cover, take out paper roll.
- (2) Wait till printing head cooling if it just finished printing.
- (3) Clean printing head completely using swab with alcohol (without water).
- (4) Until alcohol completely volatilized, close top cover.
- (5) Connect power again, print self test to check if it is clean.

#### Notice:

- (1) Please make sure power off when maintaining printer.
- (2) Don't touch or scratch printing head surface, roller and sensor.
- (3) Avoid gas, acetone or other organic solvent.
- (4) Wait till alcohol completely volatilized, close top cover and connect power again. Try print self test to make sure it works properly

#### Warning:

No part of this manual can be changed without agreement. The company reserves the right to modify the technologic, components, software and hardware. You may ask the distributors for more product information. No part of chapter in this manual can be copied or transmitted in any format without permission.