

# Understanding and Specifying Gesture 442 Series Work Chairs

## Work Chairs

**Highly adjustable task seating** offers maximum personalization for fit and comfort for a range of duration and use. By making a series of simple adjustments, you can customize the chair to your body, preferences, and tasks. These chairs provide continuous, stable, comfort, and can be quickly adjusted to support you in upright, and reclining work postures.

- Gesture 442 Series
- Leap 462 Series
- Think 465 Series
- Amia 482 Series
- Reply 466 Series
- Jersey Series
- Leap 464 Series WorkLounge
- Criterion 453 Series

## Adjustability Features

▶ See page 24 for a comparison to other chairs.

**Gesture  
442  
Series**

### Mechanisms

Advanced Synchro-tilt ●

### Seat Adjustments

Pneumatic height ●

Passive seat edge angle ●

Seat angle ●

Seat depth ●

### Back Adjustments

Back tension ●

Core equalizer ●

Lumbar height ●

Variable back stop ●

### Arm Adjustments

Arm height ●

Arm width ●

Arm pivot ●

Arm depth ●

### Other Features

Foot ring height (stool) ●

Headrest ●

## Product Details

Gesture 442 Series	30
Gesture Upholstery	34
Dimensions	36

## Specifying

Gesture 442 Series Work Chairs	38
Gesture 442 Series Work Chair with Headrest	40
Gesture 442 Series Stools	42

# Gesture 442 Series

**Gesture** is a new sitting experience that is designed for the interface between user and technology, inspired by the movement of the human body, and created for the way we work today.

**Back frame, back shell, seat perimeter, arms, and base** are standard in black/black or dark/dark color schemes. Polished aluminum base, dark/light, or light/light color schemes are available as options.

**Core equalizer** provides just the right amount of lumbar support in any angle of recline.

**Casters** have hard, dual wheels that roll smoothly on carpets. They are 2½" for increased mobility. Soft, dark grey treaded, dual-wheel roll-control casters are available for use on hard floors or mats. Glides are also available as an option.

*Tip: Do not roll the chair across asphalt during installation as this may damage the casters.*

**Variable back stop with four positions** is standard.

**Back tension** requires only 3½ complete turns and accommodates a broader range of users by allowing user to change the rate of increase in force as the chair reclines.

**Pneumatic adjustment mechanism** is standard. It adjusts with a 5" range. A 3¾" low-range pneumatic seat-height adjustment and a 5½" high-range pneumatic seat-height adjustment are available as options on chairs. Stools have an 8" range.

**Seat depth** adjusts 2¾" to accommodate various leg lengths.

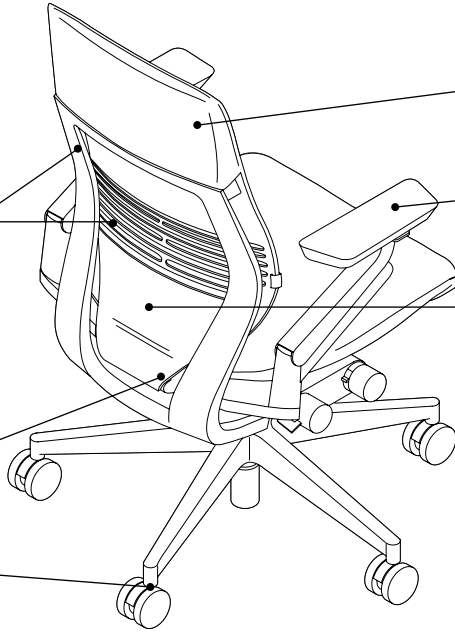

**Wrapped upper back upholstery design** is available.

**360° arm** enables 360° of motion to give arm support where it is needed with one release.

**3D LiveBack** moves with the shape of the user's spine as sitting positions change.

**Outer back and outer seat** are plastic.

**Arm depth** can retract 2⅛" to allow user to get closer to worksurface and into tight corners.

**Soft arm caps** independently pivot 15° inward and 15° outward to accommodate individual user preferences.

**Arm width** can adjust parallel from 10¼" to 22½" for forearm and elbow support.

**Arm height** can adjust 4¼" for arm and elbow support.

**Passive seat edge angle** allows the front edge of the seat to flex 1½" to relieve pressure under the user's thighs.

**Seat perimeter** is made of flexible elastomer that provides comfort to larger users and allows alternative postures.

**Five-arm base** is plastic, a polished aluminum base is available as an option.

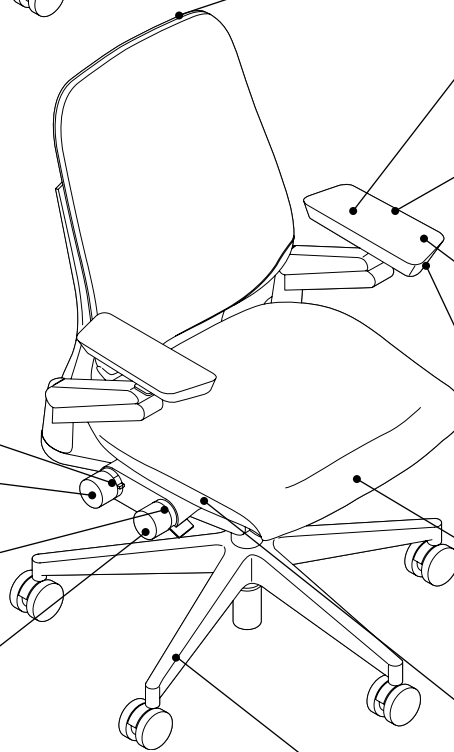

**Product Details**

**Adjustability instructions** are included with every chair. Instructions can also be found at [www.steelcase.com](http://www.steelcase.com).

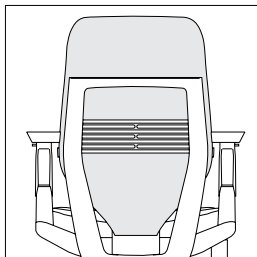

**3D LiveBack** allows the back to move and conform laterally, sagittally, and torsionally to support individual users.

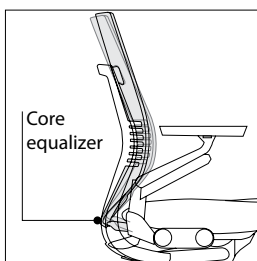

**The core equalizer** is powered by a torsional spring that adjusts with the angle of the seat and back to provide less lumbar support in a deep recline and more lumbar support in an upright posture.

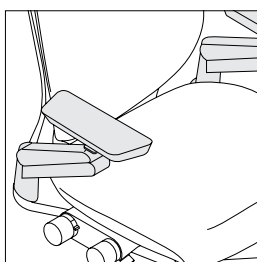

**Rectilinear arms with soft caps** are standard.

**Adjustment Features**

**Seat Adjustments**

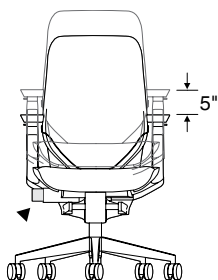

**Seat height adjusts pneumatically.** To lower, hold handle up while seated. To raise, hold handle up and keep weight off the chair. Range of adjustability is 5", from 16"H to 21"H, and is standard on work chairs. An optional 5 1/2" high-range of adjustability (17"H to 22 1/2"H) and a 3 3/4" low-range (14 1/2"H to 18 1/4"H) are available as an option. Stools are standard with an 8 1/4" range of adjustability (24"H to 32 1/4"H).

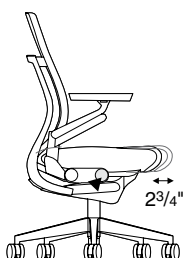

**Seat depth** adjusts 2 3/4" (15 3/4" to 18 1/2") by rotating dial while seated for an easy fine-tuned fit. This feature is standard on work chairs and stools.

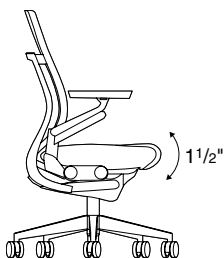

**Passive seat edge angle** flexes 1 1/2", relieving pressure under the user's thighs. This feature is standard on all work chairs and stools.

**Flexible side edges.** Comfort goes all the way to edges and requires no adjustment. Perfect for large users and has the ability to side sit.

**Adaptive bolstering.** The seat has air pockets carefully placed beneath the foam to give consistent comfort and support to a range of users.

**Back Adjustments**

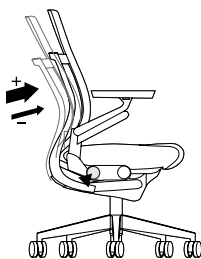

**Back tension.** Turn the knob forward for more resistance and backward for less resistance. Adjust back tension for appropriate amount of resistance.

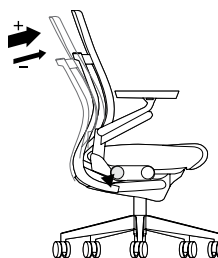

**Variable back stop.** To lock backrest in upright position, lean forward and flip lever down. Flip lever up to unlock for full-range motion. There are four settings to give just the right angle of recline.

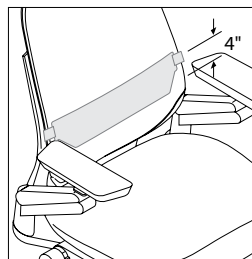

**Lumbar height** adjusts 4" (5 1/4" to 9 1/4") from seat by grabbing exposed tabs and sliding the lumbar support up or down. This feature is optional on work chairs and stools.

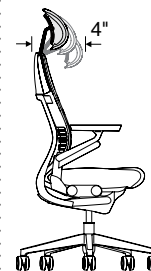
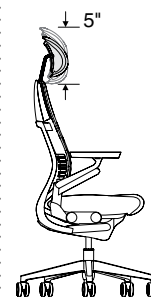

**Headrest** adjusts 5" vertically and measures 8"H x 10 1/2"W. It tilts 4" forward and the cushion rotates 90°. Plastic shell on the headrest is available in black, merle, or seagull and will match the plastic back shell. Upholstery can match or contrast the seat and back material. It is not available to order separately for installation on existing Gesture chairs. Headrest is available on stools as a special only.

**Arm Adjustments**

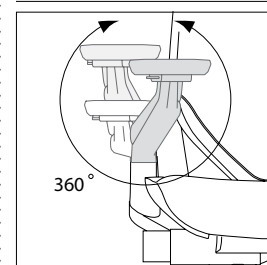

**360°-arm.** One release enables 360° of motion to give arms support where it is needed. To adjust arm cap position, grasp arm caps and slide in any direction. The 360° provide a great dimensional range for large users and many postures, and ensures proper support when using a range of technology, mobile or fixed.

Gesture 442 Series, continued

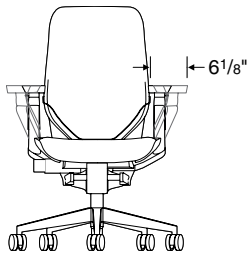

**Arm width** adjusts parallel 6 1/8" per arm for a total range of 10 1/4" to 22 1/2" between arms.

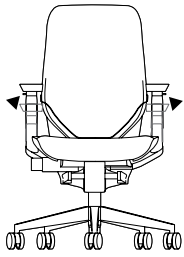

**Arm height** adjusts independently 4 1/4" (7 1/4"H to 11 1/2"H) to relieve upper back and shoulder fatigue.

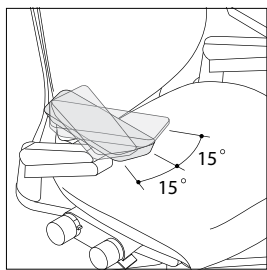

**Arms pivot** independently 15° inward and 15° outward. Grasp arm and push front to left or right.

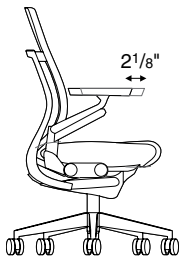

**Arm depth** adjusts 2 1/8" to enable user to get closer to worksurface.

**Other features**

**Cartoned** request on dealer purchase order forces Gesture chairs to ship knocked down in three pieces; the seat and back, the base, and the pneumatic cylinder. This allows for shipment in a smaller carton. Assembly by a qualified dealer installer is required. Assembly instructions are included. This does not apply to Gesture stools. No additional tools are required for assembly.



**Armless models** are also available.

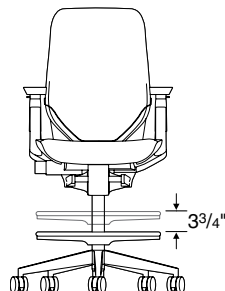

**Column and foot ring on stools** adjusts by first lifting ring and rotating it counterclockwise to unlock. Then raise or lower ring up to 3 3/4" to desired position before rotating it clockwise to lock.

**Surface Materials**

▶ See surface materials on page 628 for specific availability or refer to the *Surface Materials Reference Manual* for further information.

**Open slats in the back shell** will appear as a matching color to the back surface material if specified with Cogent:Connect or 3D Knit. Slats will appear as black if any other seating material is specified.

**Upholstery**

- Fabric
- Fabric with soil-retardant treatment (option)
- 3D Knit (back and headrest only)
- Leather
- Elmosoft leather
- Select Surfaces leather
- Vinyl
- COM
- COL

**Hard components**

(back frame, outer back, arm retainer, and base)

- 4799 Platinum
- 6053 Seagull
- 6205 Black
- 6527 Merle
- 7250 Sterling Dark
- 8046 Polished Aluminum

▶ See color scheme matrix.

Headrest shell is determined by the color scheme.

- 6053 Seagull
- 6205 Black
- 6527 Merle

Stool footing finish is determined by the color scheme.

- 0835 Black (Black/Black, Dark/Dark)
- 4799 Platinum Metallic (Dark/Light, Light/Light)

**Arm caps**

- Black
- Leather



**Polished aluminum base** is available.

**All Steelcase seating**

with standard upholstery fabrics complies with requirements of the State of California Technical Bulletin 117-2013. All standard seating is labeled to be in compliance with California 117-2013.

**Programs & Services**

▶ See the *Surface Materials Reference Manual* for further detail about programs and services offered for seating.

**The Customer's Own Material (COM) Program**

offers the standard opportunity for customers to select fabrics that are not offered through the standard Steelcase surface materials program for use on Steelcase products.

Through the COM program, Steelcase will test your materials for application on Steelcase products. Once approved, you can place your order. Steelcase will facilitate the entire ordering process and give you a production schedule. Steelcase will order the COM fabric directly from the textile manufacturer. For up-to-date information regarding fabric test results for all COM fabrics and details regarding yardage requirements for most Seating lines, visit the COM website. To locate the COM website:

- Visit [www.steelcase.com](http://www.steelcase.com)

**Soil retardants** are treatments that provide long-term soil and stain resistance to a fabric without affecting the shade or the integrity of the fabric. The following Steelcase Textiles are available pre-treated with soil retardant. (You do not need to select the soil-retardant option for these fabrics and incur the upcharge.)

- Jacks
- Link
- Spyder

For information on soil retardant fabrics on Select Surfaces, please refer to the *Surface Materials Reference Manual*.

Soil-retardant treatment is available on all other seating fabrics at an additional upcharge per seating unit. To order this option, please select "Soil-Retardant Treatment" under "Optional Accessories."

For soil-retardant treatment on COMs, please select "Soil-Retardant Treatment" under "Optional Accessories." Minimums or additional yardage may be required. Please contact the vendor directly for specific information. Extended lead times may be necessary for this service.

Contact your Steelcase Solutions Fulfillment Team Representative at 1.888.STEELCASE (1.888.783.3522) or send an email to [lineone@steelcase.com](mailto:lineone@steelcase.com).

**Dimensions**

▶ Page 36

**Resources**

**Online Resources**

- ▶ Interactive User Guide available on [www.steelcase.com](http://www.steelcase.com)
- ▶ Model sales conversation available on [village.steelcase.com](http://village.steelcase.com)
- ▶ Adjustability video available on [www.steelcase.com](http://www.steelcase.com)
- ▶ Environmental profiles available on [www.steelcase.com/sustainability](http://www.steelcase.com/sustainability).

<b>Color Scheme Matrix</b>						
<b>Color Scheme</b>	<b>Back Frame</b>	<b>Back Shell /Headrest</b>	<b>Seat Perimeter</b>	<b>Arms</b>	<b>Base</b>	<b>Cylinder</b>
Black/Black	Molded Black-6205	Molded Black-6205	Molded Black-6205	Molded Black-6205	Molded Black-6205 or optional Polished Aluminum-8046	Painted Black-0835
Dark/Dark	Painted Sterling Dark Textured-7250	Molded Merle-6527	Molded Merle-6527	Molded Merle-6527	Painted Sterling Dark Textured-7250 or optional Polished Aluminum-8046	Painted Black-0835
Dark/Light	Painted Platinum Metallic-4799	Molded Merle-6527	Molded Merle-6527	Molded Merle-6527	Painted Platinum Metallic-4799 or optional Polished Aluminum-8046	Painted Platinum Metallic-4799
Light/Light	Painted Platinum Metallic-4799	Molded Seagull -6053	Molded Seagull -6053	Molded Merle-6527	Painted Platinum Metallic-4799 or optional Polished Aluminum-8046	Painted Platinum Metallic-4799

# Gesture Upholstery

## What Is It?

Fabric, leather, or vinyl-covered back and seat, 3D Knit back.

### Standard upholstery design

**Cogent: Connect**

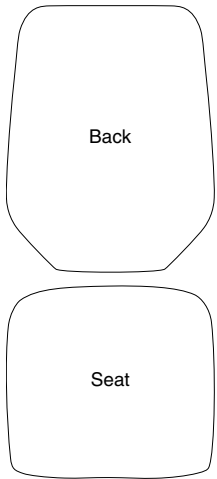

### 3D Knit on Back only

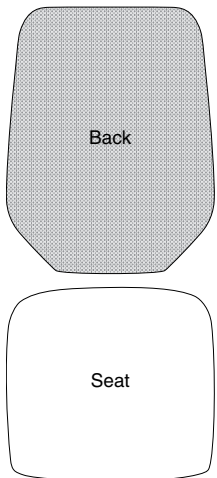

**3D Knit back** is made up of three layers: the 3D Knit, a solid fabric that matches the 3D Knit color, and the polyurethane cushion that provides exceptional comfort. The seat on these models can be specified with Cogent: Connect fabric colors to match the 3D Knit color, or in any other material.

### Stitched upholstery design

**Leather, Vinyl, and All Other Fabrics**

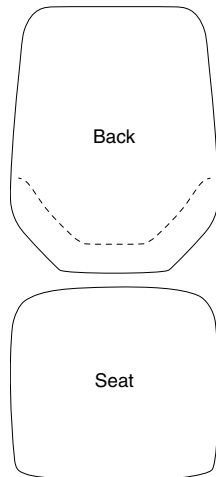

**Stitched seams** are included on the back cushion of the following:

- Leather
- Vinyl
- Upholstery
- Customer's Own Leather (COL)
- Vinyl
- Select Customer's Own Material/Vinyl (COM)

**Pattern alignment at the lumbar seam** cannot be guaranteed.

**Open slats in the back shell** will appear as a matching color to the back surface material if specified with Cogent:Connect or 3D Knit. Slats will appear as black if any other seating material is specified.

### Chairs with headrest only

**Leather, Vinyl, and All Other Fabrics**

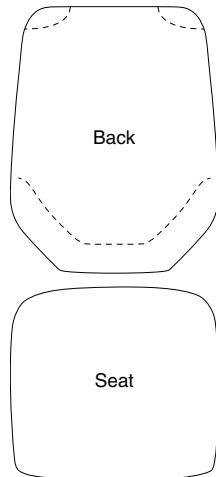

**Additional stitched seams in the upper left and right corner of the back cushion on Gesture chairs with headrest** are included of the following:

- Leather
- Vinyl
- Upholstery
- Customer's Own Leather (COL)
- Vinyl
- Select Customer's Own Material/Vinyl (COM)

*Tip: Fabrics that show a distinct pattern or texture may demonstrate an undesirable contrast at the upper left and right corners of the top of the back.*

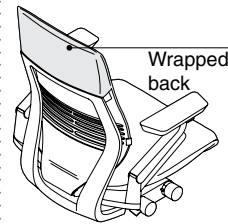
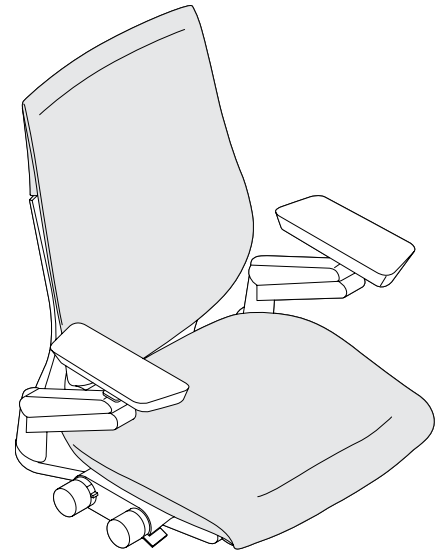

**Wrapped upper back** is upholstered to the top of the back frame.

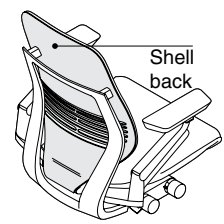

**Plastic shell back** is fully exposed.

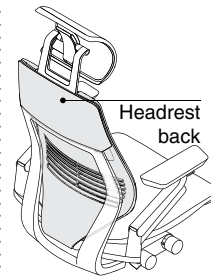

**Headrest chair back** is upholstered to the top of the back frame.

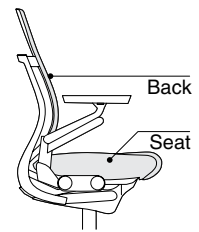

**Seat and back cushions** can be removed and replaced if damaged.



# Dimensions

## Gesture 442 Series

Features	Overall Depth	Width	Height	Seat Depth	Functional Seat Depth	Seat Width	Seat Height from Floor	Ring Height from Floor	Back Width	Back Height from Seat
----------	---------------	-------	--------	------------	-----------------------	------------	------------------------	------------------------	------------	-----------------------

### Gesture 442 Series

#### Work Chairs

Adjustable Seat Depth	21" to 23 <sup>5</sup> / <sub>8</sub> "	22 <sup>3</sup> / <sub>8</sub> " to 34 <sup>5</sup> / <sub>8</sub> "	39 <sup>1</sup> / <sub>4</sub> " to 44 <sup>1</sup> / <sub>4</sub> "	18 <sup>1</sup> / <sub>4</sub> "	15 <sup>3</sup> / <sub>4</sub> " to 18 <sup>1</sup> / <sub>2</sub> "	20"	16" to 21" (14 <sup>1</sup> / <sub>2</sub> " to 18 <sup>1</sup> / <sub>4</sub> ", 17" to 22 <sup>1</sup> / <sub>2</sub> " optional)	N.A.	16 <sup>1</sup> / <sub>4</sub> "	24 <sup>1</sup> / <sub>16</sub> "
-----------------------	---	--	--	----------------------------------	--	-----	---	------	----------------------------------	-----------------------------------

#### Work Chair with Headrest

Adjustable Seat Depth	21" to 23 <sup>5</sup> / <sub>8</sub> "	22 <sup>3</sup> / <sub>8</sub> " to 34 <sup>5</sup> / <sub>8</sub> "	47" to 57"	18 <sup>1</sup> / <sub>4</sub> "	15 <sup>3</sup> / <sub>4</sub> " to 18 <sup>1</sup> / <sub>2</sub> "	20"	16" to 21" (14 <sup>1</sup> / <sub>2</sub> " to 18 <sup>1</sup> / <sub>4</sub> ", 17" to 22 <sup>1</sup> / <sub>2</sub> " optional)	N.A.	16 <sup>1</sup> / <sub>4</sub> "	25 <sup>3</sup> / <sub>8</sub> "
-----------------------	---	--	------------	----------------------------------	--	-----	---	------	----------------------------------	----------------------------------

#### Stools

Adjustable Seat Depth	21" to 23 <sup>5</sup> / <sub>8</sub> "	22 <sup>3</sup> / <sub>8</sub> " to 34 <sup>5</sup> / <sub>8</sub> "	47 <sup>3</sup> / <sub>8</sub> " to 55 <sup>5</sup> / <sub>8</sub> "	18 <sup>1</sup> / <sub>4</sub> "	15 <sup>3</sup> / <sub>4</sub> " to 18 <sup>1</sup> / <sub>2</sub> "	20"	24" to 32 <sup>1</sup> / <sub>4</sub> "	10 <sup>1</sup> / <sub>4</sub> " to 14"	16 <sup>1</sup> / <sub>4</sub> "	24 <sup>1</sup> / <sub>16</sub> "
-----------------------	---	--	--	----------------------------------	--	-----	---	---	----------------------------------	-----------------------------------

Dimensions were measured with BIFMA CMD (chair-measuring device).

\*Seat width at the front of the cushion is 18<sup>1</sup>/<sub>4</sub>"W.

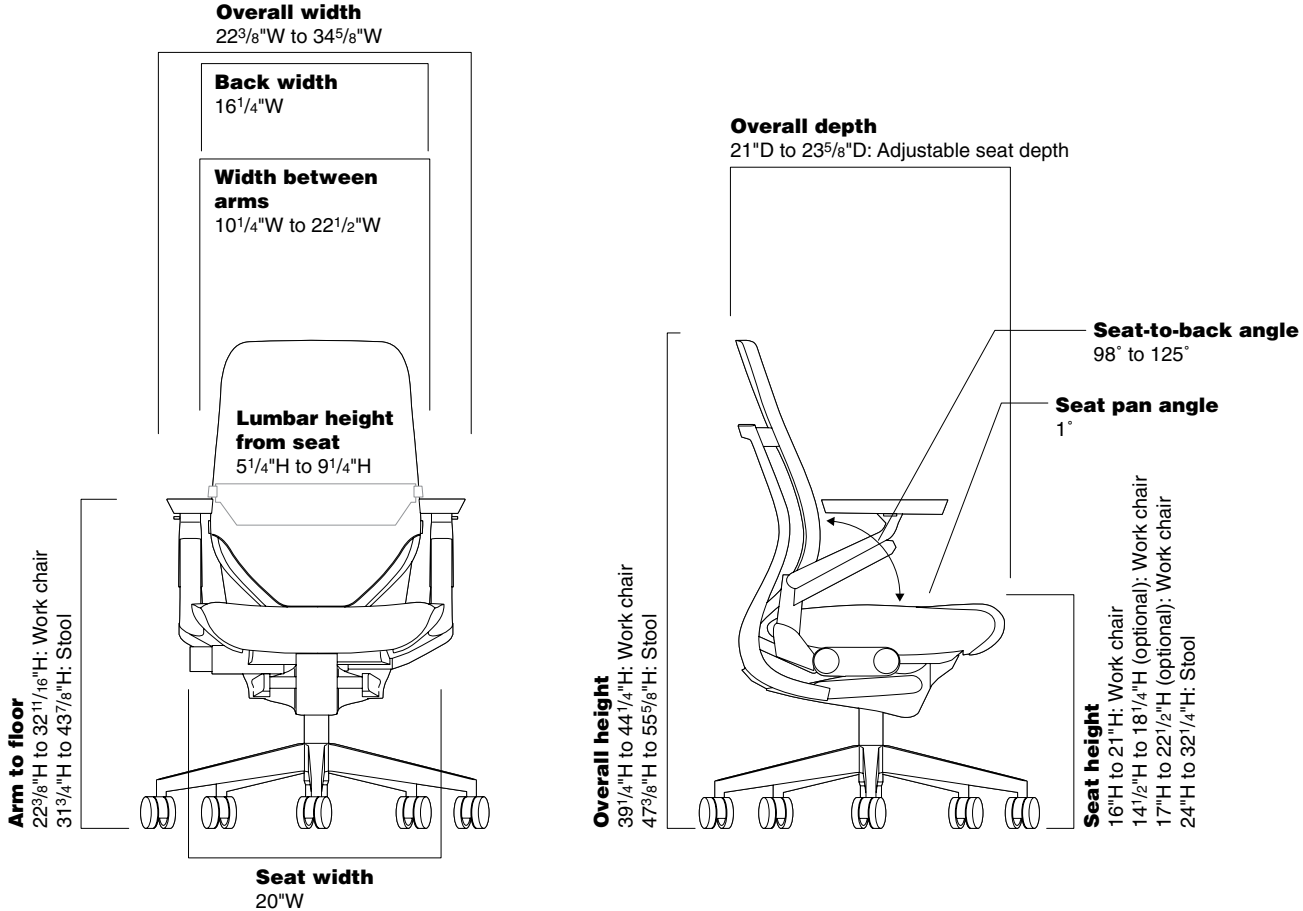

• Back Lumbar Height	• Lumbar Flex Zone	• Width Between Arms	• Width Between Fixed Arms	• Arm to Floor	• Arm Height from Seat	• Arm Cap Pivot Range	• Seat Pan Angle	• Angle Between Seat and Back
----------------------	--------------------	----------------------	----------------------------	----------------	------------------------	-----------------------	------------------	-------------------------------

**Work Chairs**

9 1/4"	4"	10 1/4" to 22 1/2"	19"	23 3/8" to 32 1/16"	7 1/4" to 11 1/2"	15° inward, 15° outward	1°	98° to 125°
--------	----	--------------------	-----	---------------------	-------------------	-------------------------	----	-------------

**Work Chair with Headrest**

9 1/4"	4"	10 1/4" to 22 1/2"	19"	23 3/8" to 32 1/16"	7 1/4" to 11 1/2"	15° inward, 15° outward	1°	98° to 125°
--------	----	--------------------	-----	---------------------	-------------------	-------------------------	----	-------------

**Stools**

9 1/4"	4"	10 1/4" to 22 1/2"	19"	31 1/4" to 43 7/8"	7 1/4" to 11 1/2"	15° inward, 15° outward	1°	98° to 125°
--------	----	--------------------	-----	--------------------	-------------------	-------------------------	----	-------------

# Gesture 442 Series Work Chairs

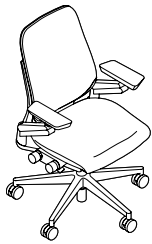

Tip: For more information regarding color schemes, see page 33.

Tip: Seat and back will be a matching textile unless 3D Knit is specified.

► Detailed dimensions, page 36



**For Canadian Pricing**  
Multiply U.S. Price by the Canadian price factor.  
► See page 1 for details.

Standard Includes		Required to Specify
► Need help? Product details, page 30	<ul style="list-style-type: none"> <li>• 5" pneumatic seat-height adjustment (16"–21")</li> <li>• 360° independent height-, width-, pivot-, and depth-adjustable arms and soft arm caps: black plastic</li> <li>• Frame, seat shell, outer back, and five-arm base: plastic</li> <li>• 2<sup>3</sup>/<sub>4</sub>" seat depth adjustment</li> <li>• Standard upholstery design on seat: fabric price group 1</li> <li>• Shell back chair, if selected: fabric price group 1</li> <li>• Wrapped back chair, if selected: fabric price group 1</li> <li>• 3D Knit on back only, if selected</li> <li>• 2<sup>1</sup>/<sub>2</sub>" diameter, hard-composition, dual-wheel casters: black</li> </ul>	<ol style="list-style-type: none"> <li>1 Style number</li> <li>2 Plastic color scheme for frame, seat shell, outer back, and base (see below under Required Selections)</li> <li>3 Fabric color number for upholstery on seat and back, if selected</li> <li>4 3D Knit color number for upholstery on back, if selected</li> <li>5 Options, if selected (see below)</li> </ol> <p>► See <i>Surface Materials</i>, page 628.</p>

Required Selections	U.S. Price	Required to Specify
<b>Color Scheme</b>		
• Black/Black	No cost	Specify with <i>black/black color scheme</i> .
• Dark/Dark	+\$ 48	Specify with <i>dark/dark color scheme</i> .
• Dark/Light	+\$ 48	Specify with <i>dark/light color scheme</i> .
• Light/Light	+\$ 48	Specify with <i>light/light color scheme</i> .

Options	U.S. Price	Required to Specify
<b>Surface Materials</b>		
<b>Contrasting</b>		
• Contrasting fabrics	+\$ 34	Specify with <i>contrasting</i> .
<b>Upholstery on seat</b>		
• Fabric price group 1	No cost	Specify fabric color number.
• Fabric price group 2	+\$ 10	Specify fabric color number.
• Fabric price group 3	+\$ 28	Specify fabric color number.
• Fabric price group 4	+\$ 37	Specify fabric color number.
• Fabric price group 5	+\$ 44	Specify fabric color number.
• Fabric price group 6	+\$ 54	Specify fabric color number.
• Fabric price group 7	+\$ 65	Specify fabric color number.
• Fabric price group 8	+\$ 81	Specify fabric color number.
• Fabric price group 9	+\$ 99	Specify fabric color number.
• Fabric price group 10	+\$114	Specify fabric color number.
• Steelcase leather upholstery	+\$328	Specify leather color number.
• Select Surfaces leather price group 1	+\$328	► See <i>Surface Materials Reference Manual</i> . Specify Elmosoft leather color number.
• Elmosoft leather upholstery	+\$386	► See <i>Surface Materials Reference Manual</i> . Specify vinyl color number.
• Select Surfaces leather price group 2	+\$386	► See <i>Surface Materials Reference Manual</i> .
• Steelcase vinyl	+\$ 10	Specify vinyl color number.
• Customer's Own Material/Vinyl (COM-Sewn)	No cost	► See <i>Surface Materials Reference Manual</i> .
• Customer's Own Leather (COL-Sewn)	+\$142	Specify leather color number.
<b>Upholstery on back</b>		
• Fabric price group 1	No cost	Specify fabric color number.
• Fabric price group 2	+\$ 10	Specify fabric color number.
• Fabric price group 3	+\$ 28	Specify fabric color number.
• Fabric price group 4	+\$ 37	Specify fabric color number.
• Fabric price group 5	+\$ 44	Specify fabric color number.
• Fabric price group 6	+\$ 54	Specify fabric color number.
• Fabric price group 7	+\$ 65	Specify fabric color number.
• Fabric price group 8	+\$ 81	Specify fabric color number.
• Fabric price group 9	+\$ 99	Specify fabric color number.
• Fabric price group 10	+\$114	Specify fabric color number.
• 3D Knit	+\$ 62	Specify 3D Knit fabric color number.
• Steelcase leather upholstery	+\$328	Specify leather color number.
• Select Surfaces leather price group 1	+\$328	► See <i>Surface Materials Reference Manual</i> . Specify Elmosoft leather color number.
• Elmosoft leather upholstery	+\$386	► See <i>Surface Materials Reference Manual</i> . Specify vinyl color number.
• Select Surfaces leather price group 2	+\$386	► See <i>Surface Materials Reference Manual</i> .
• Steelcase vinyl	+\$ 10	Specify vinyl color number.
• Customer's Own Material/Vinyl (COM-Sewn)	No cost	► See <i>Surface Materials Reference Manual</i> .
• Customer's Own Leather (COL-Sewn)	+\$142	Specify leather color number.
<b>Soil-retardant treatment</b>	+\$ 28	Specify with <i>soil-retardant treatment</i> .

► Options, continued on next page

► Options, continued from previous page

Options	U.S. Price	Required to Specify
<b>Surface Materials, continued</b>	<b>Polished aluminum base package</b>	
• Polished aluminum base on chairs	+\$148	Specify with polished aluminum base.
<b>Arms</b>		
• 360° independent height-, width-, pivot-, and depth-adjustable arms with leather arm caps	+\$176	Specify with 360° independent height-, width-, pivot-, and depth-adjustable arms and select leather color number.
• 360° independent height-, width-, pivot-, and depth-adjustable arms with Elmosoft leather arm caps	+\$206	Specify with 360° independent height-, width-, pivot-, and depth-adjustable arms and select Elmosoft leather color number.
• Fixed arms	-\$104	Specify with fixed arms.
• Armless	-\$296	Specify without arms.
<b>Seat Height</b>		
• 3 <sup>3</sup> / <sub>4</sub> " low-range pneumatic seat-height adjustment (14 <sup>1</sup> / <sub>2</sub> " to 18 <sup>1</sup> / <sub>4</sub> ")	+\$ 63	Specify with low-range pneumatic seat-height adjustment.
• 5 <sup>1</sup> / <sub>2</sub> " high-range pneumatic seat-height adjustment (17" to 22 <sup>1</sup> / <sub>2</sub> ")	+\$ 63	Specify with high-range pneumatic seat-height adjustment.
<b>Lumbar</b>	• Adjustable lumbar support	+\$ 34
		Specify with adjustable lumbar height.
<b>Casters</b>	• Soft, dark grey treaded, dual-wheel roll-control casters for use on hard floors	+\$ 28
		Specify with soft roll-control casters.
<b>Glides</b>	• Glides: plastic	+\$ 28
		Specify with glides.

Specification Information

• <b>Style</b>	• <b>U.S.</b>
• <b>Number</b>	• <b>Base</b>
•	• <b>Price</b>
•	•
•	•

**Wrapped Back Chair**

442A40 \$1678

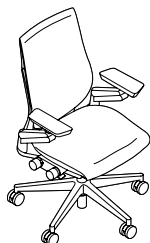

**Shell Back Chair**

442A30 \$1649



**For Canadian Pricing**

Multiply U.S. Price by the Canadian price factor.

► See page 1 for details.

# Gesture 442 Series Work Chair with Headrest

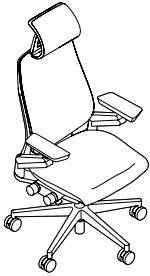

Tip: For more information regarding color schemes, see page 33.

Tip: Headrest upholstery can match or contrast the seat and back upholstery.

Tip: Seat and back will be a matching textile unless 3D Knit is specified.

► Detailed dimensions, page 36



**For Canadian Pricing**  
Multiply U.S. Price by the Canadian price factor.  
► See page 1 for details.

Standard Includes		Required to Specify
► Need help? Product details, page 30	<ul style="list-style-type: none"> <li>• 5" pneumatic seat-height adjustment (16"–21")</li> <li>• 360° independent height-, width-, pivot-, and depth-adjustable arms and soft arm caps: black plastic</li> <li>• Frame, seat shell, outer back, and five-arm base: plastic</li> <li>• 2¾" seat depth adjustment</li> <li>• Standard upholstery design on seat: fabric price group 1</li> <li>• Adjustable headrest, standard upholstery</li> <li>• 3D Knit on back and headrest only, if selected</li> <li>• 2½" diameter, hard-composition, dual-wheel casters: black</li> </ul>	<ol style="list-style-type: none"> <li>1 Style number</li> <li>2 Plastic color scheme for frame, seat shell, outer back, headrest, and base (see below under Required Selections)</li> <li>3 Fabric color number for upholstery on seat and back, if selected</li> <li>4 Fabric color number for upholstery on headrest</li> <li>5 3D Knit color number for upholstery on back, if selected</li> <li>6 Options, if selected (see below)</li> </ol> <p>► See <i>Surface Materials</i>, page 628.</p>

Required Selections	U.S. Price	Required to Specify
<b>Color Scheme</b>		
• Black/Black	No cost	Specify with <i>black/black color scheme</i> .
• Dark/Dark	+\$ 48	Specify with <i>dark/dark color scheme</i> .
• Dark/Light	+\$ 48	Specify with <i>dark/light color scheme</i> .
• Light/Light	+\$ 48	Specify with <i>light/light color scheme</i> .

Options	U.S. Price	Required to Specify
<b>Surface Materials</b>		
<b>Contrasting</b>		
• Contrasting fabrics	+\$ 34	Specify with <i>contrasting</i> .
<b>Upholstery on seat</b>		
• Fabric price group 1	No cost	Specify fabric color number.
• Fabric price group 2	+\$ 10	Specify fabric color number.
• Fabric price group 3	+\$ 28	Specify fabric color number.
• Fabric price group 4	+\$ 37	Specify fabric color number.
• Fabric price group 5	+\$ 44	Specify fabric color number.
• Fabric price group 6	+\$ 54	Specify fabric color number.
• Fabric price group 7	+\$ 65	Specify fabric color number.
• Fabric price group 8	+\$ 81	Specify fabric color number.
• Fabric price group 9	+\$ 99	Specify fabric color number.
• Fabric price group 10	+\$114	Specify fabric color number.
• Steelcase leather upholstery	+\$328	Specify leather color number.
• Select Surfaces leather price group 1	+\$328	► See <i>Surface Materials Reference Manual</i> . Specify Elmosoft leather color number.
• Elmosoft leather upholstery	+\$386	► See <i>Surface Materials Reference Manual</i> . Specify vinyl color number.
• Select Surfaces leather price group 2	+\$386	► See <i>Surface Materials Reference Manual</i> .
• Steelcase vinyl	+\$ 10	Specify vinyl color number.
• Customer's Own Material/Vinyl (COM-Sewn)	No cost	► See <i>Surface Materials Reference Manual</i> .
• Customer's Own Leather (COL-Sewn)	+\$142	Specify leather color number.
<b>Upholstery on back</b>		
• Fabric price group 1	No cost	Specify fabric color number.
• Fabric price group 2	+\$ 10	Specify fabric color number.
• Fabric price group 3	+\$ 28	Specify fabric color number.
• Fabric price group 4	+\$ 37	Specify fabric color number.
• Fabric price group 5	+\$ 44	Specify fabric color number.
• Fabric price group 6	+\$ 54	Specify fabric color number.
• Fabric price group 7	+\$ 65	Specify fabric color number.
• Fabric price group 8	+\$ 81	Specify fabric color number.
• Fabric price group 9	+\$ 99	Specify fabric color number.
• Fabric price group 10	+\$114	Specify fabric color number.
• 3D Knit	+\$ 62	Specify 3D Knit fabric color number.
• Steelcase leather upholstery	+\$328	Specify leather color number.
• Select Surfaces leather price group 1	+\$328	► See <i>Surface Materials Reference Manual</i> . Specify Elmosoft leather color number.
• Elmosoft leather upholstery	+\$386	► See <i>Surface Materials Reference Manual</i> . Specify vinyl color number.
• Select Surfaces leather price group 2	+\$386	► See <i>Surface Materials Reference Manual</i> .
• Steelcase vinyl	+\$ 10	Specify vinyl color number.
• Customer's Own Material/Vinyl (COM-Sewn)	No cost	► See <i>Surface Materials Reference Manual</i> .
• Customer's Own Leather (COL-Sewn)	+\$142	Specify leather color number.
<b>Soil-retardant treatment</b>	+\$ 28	Specify with <i>soil-retardant treatment</i> .

► Options, continued on next page

► Options, continued from previous page

Options	U.S. Price	Required to Specify
<b>Surface Materials, continued</b>	<b>Polished aluminum base package</b>	
	• Polished aluminum base on chairs	+\$148
		Specify with polished aluminum base.
<b>Arms</b>	• 360° independent height-, width-, pivot-, and depth-adjustable arms with leather arm caps	+\$176
	• 360° independent height-, width-, pivot-, and depth-adjustable arms with Elmosoft leather arm caps	+\$206
	• Fixed arms	-\$104
	• Armless	-\$296
		Specify with 360° independent height-, width-, pivot-, and depth-adjustable arms and select leather color number.
		Specify with 360° independent height-, width-, pivot-, and depth-adjustable arms and select Elmosoft leather color number.
		Specify with fixed arms.
		Specify without arms.
<b>Seat Height</b>	• 3 <sup>3</sup> / <sub>4</sub> " low-range pneumatic seat-height adjustment (14 <sup>1</sup> / <sub>2</sub> " to 18 <sup>1</sup> / <sub>4</sub> ")	+\$ 63
	• 5 <sup>1</sup> / <sub>2</sub> " high-range pneumatic seat-height adjustment (17" to 22 <sup>1</sup> / <sub>2</sub> ")	+\$ 63
		Specify with low-range pneumatic seat-height adjustment.
		Specify with high-range pneumatic seat-height adjustment.
<b>Lumbar</b>	• Adjustable lumbar support	+\$ 34
		Specify with adjustable lumbar height.
<b>Casters</b>	• Soft, dark grey treaded, dual-wheel roll-control casters for use on hard floors	+\$ 28
		Specify with soft roll-control casters.
<b>Glides</b>	• Glides: plastic	+\$ 28
		Specify with glides.

Specification Information

Style Number	U.S. Base Price
442A50	\$1957
:	:

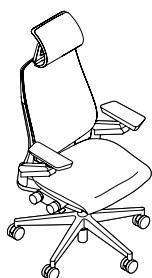

Gesture 442 Series

 **For Canadian Pricing**  
Multiply U.S. Price by the Canadian price factor.  
► See page 1 for details.

# Gesture 442 Series Stools

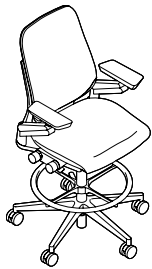

Tip: For more information regarding color schemes, see page 33.

Tip: Seat and back will be a matching textile unless 3D Knit is specified.

► Detailed dimensions, page 36



## For Canadian Pricing

Multiply U.S. Price by the Canadian price factor.

► See page 1 for details.

Standard Includes		Required to Specify
► Need help? Product details, page 30	<ul style="list-style-type: none"> <li>• 8 1/4" pneumatic seat-height adjustment (24"–32 1/4")</li> <li>• 360° independent height-, width-, pivot-, and depth-adjustable arms and soft arm caps: black plastic</li> <li>• Frame, seat shell, outer back, and five-arm base: plastic</li> <li>• 2 3/4" seat depth adjustment</li> <li>• Column and 4" adjustable foot ring</li> <li>• Standard upholstery design on seat: fabric price group 1</li> <li>• Shell back stool, if selected: fabric price group 1</li> <li>• Wrapped back stool, if selected: fabric price group 1</li> <li>• 3D Knit on back only, if selected</li> <li>• 2 1/2" diameter, hard-composition, dual-wheel casters: black</li> </ul>	<ol style="list-style-type: none"> <li>1 Style number</li> <li>2 Plastic color scheme for frame, seat shell, outer back, and base (see below under Required Selections)</li> <li>3 Fabric color number for upholstery on seat and back, if selected</li> <li>4 3D Knit color number for upholstery on back, if selected</li> <li>5 Options, if selected (see below)</li> </ol> <p>► See <i>Surface Materials</i>, page 628.</p>

Required Selections	U.S. Price	Required to Specify
<b>Color Scheme</b>		
• Black/Black	No cost	Specify with <i>black/black color scheme</i> .
• Dark/Dark	+\$ 48	Specify with <i>dark/dark color scheme</i> .
• Dark/Light	+\$ 48	Specify with <i>dark/light color scheme</i> .
• Light/Light	+\$ 48	Specify with <i>light/light color scheme</i> .

Options	U.S. Price	Required to Specify
<b>Surface Materials</b>		
<b>Contrasting</b>		
• Contrasting fabrics	+\$ 34	Specify with <i>contrasting</i> .
<b>Upholstery on seat</b>		
• Fabric price group 1	No cost	Specify fabric color number.
• Fabric price group 2	+\$ 10	Specify fabric color number.
• Fabric price group 3	+\$ 28	Specify fabric color number.
• Fabric price group 4	+\$ 37	Specify fabric color number.
• Fabric price group 5	+\$ 44	Specify fabric color number.
• Fabric price group 6	+\$ 54	Specify fabric color number.
• Fabric price group 7	+\$ 65	Specify fabric color number.
• Fabric price group 8	+\$ 81	Specify fabric color number.
• Fabric price group 9	+\$ 99	Specify fabric color number.
• Fabric price group 10	+\$114	Specify fabric color number.
• Steelcase leather upholstery	+\$328	Specify leather color number.
• Select Surfaces leather price group 1	+\$328	► See <i>Surface Materials Reference Manual</i> . Specify Elmosoft leather color number.
• Elmosoft leather upholstery	+\$386	► See <i>Surface Materials Reference Manual</i> . Specify vinyl color number.
• Select Surfaces leather price group 2	+\$386	► See <i>Surface Materials Reference Manual</i> .
• Steelcase vinyl	+\$ 10	
• Customer's Own Material/Vinyl (COM-Sewn)	No cost	
• Customer's Own Leather (COL-Sewn)	+\$142	Specify leather color number.
<b>Upholstery on back</b>		
• Fabric price group 1	No cost	Specify fabric color number.
• Fabric price group 2	+\$ 10	Specify fabric color number.
• Fabric price group 3	+\$ 28	Specify fabric color number.
• Fabric price group 4	+\$ 37	Specify fabric color number.
• Fabric price group 5	+\$ 44	Specify fabric color number.
• Fabric price group 6	+\$ 54	Specify fabric color number.
• Fabric price group 7	+\$ 65	Specify fabric color number.
• Fabric price group 8	+\$ 81	Specify fabric color number.
• Fabric price group 9	+\$ 99	Specify fabric color number.
• Fabric price group 10	+\$114	Specify fabric color number.
• 3D Knit	+\$ 62	Specify 3D knit fabric color number.
• Steelcase leather upholstery	+\$328	Specify leather color number.
• Select Surfaces leather price group 1	+\$328	► See <i>Surface Materials Reference Manual</i> . Specify Elmosoft leather color number.
• Elmosoft leather upholstery	+\$386	► See <i>Surface Materials Reference Manual</i> . Specify vinyl color number.
• Select Surfaces leather price group 2	+\$386	► See <i>Surface Materials Reference Manual</i> .
• Steelcase vinyl	+\$ 10	
• Customer's Own Material/Vinyl (COM-Sewn)	No cost	
• Customer's Own Leather (COL-Sewn)	+\$142	Specify leather color number.
<b>Soil-retardant treatment</b>	+\$ 28	Specify with <i>soil-retardant treatment</i> .

► Options, continued on next page

► Options, continued from previous page

Options	U.S. Price	Required to Specify
<b>Surface Materials, continued</b> <b>Polished aluminum base package</b> • Polished aluminum base on chairs	+\$148	Specify with polished aluminum base.
<b>Arms</b> • 360° independent height-, width-, pivot-, and depth-adjustable arms with leather arm caps • 360° independent height-, width-, pivot-, and depth-adjustable arms with Elmosoft leather arm caps • Fixed arms • Armless	+\$176 +\$206 -\$104 -\$296	Specify with 360° independent height-, width-, pivot-, and depth-adjustable arms and select leather color number. Specify with 360° independent height-, width-, pivot-, and depth-adjustable arms and select Elmosoft leather color number. Specify with fixed arms. Specify without arms.
<b>Lumbar</b> • Adjustable lumbar support	+\$ 34	Specify with adjustable lumbar height.
<b>Casters</b> • Soft, dark grey treaded, dual-wheel roll-control casters for use on hard floors	+\$ 28	Specify with soft roll-control casters.
<b>Glides</b> • Glides: plastic	+\$ 28	Specify with glides.

Specification Information

Style Number	U.S. Base Price

Wrapped Back Stool

442B40	\$1925
--------	--------

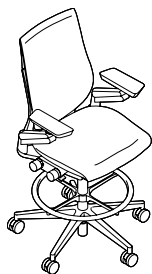

Shell Back Stool

442B30	\$1896
--------	--------

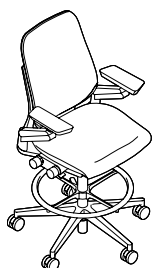

 **For Canadian Pricing**  
 Multiply U.S. Price by the Canadian price factor.  
 ► See page 1 for details.

