

HyperX Alloy FPS RGB Mechanical Gaming Keyboard

Find the language and latest documentation for your HyperX Alloy FPS RGB Gaming Keyboard here.

HyperX Alloy FPS RGB Mechanical Gaming Keyboard Installation Guide

-  For instructions in English
-  Para instrucciones en Español
-  Für Anleitungen in Deutsch
-  Pour des instructions en Français
-  Per le istruzioni in Italiano
-  Por as instruções em Português
-  Instrukcje w języku Polskim
-  Для инструкции на Русском
-  Turkce talimatlar icin
-  Japanese
-  Korean
-  Thai
-  Vietnamese
- Simplified Chinese 中文说明
- Traditional Chinese 中文說明



HyperX Alloy FPS RGB Mechanical Gaming Keyboard



Part Numbers

HX-KB1SS2-US

HX-KB1SS2-UK

HX-KB1SS2-RU

HX-KB1SS2-NO

HX-KB1SS2-LA

HX-KB1SS2-FR

HX-KB1SS2-DE



What's included:





- HyperX Alloy FPS RGB Mechanical Gaming Keyboard
- Detachable USB cable



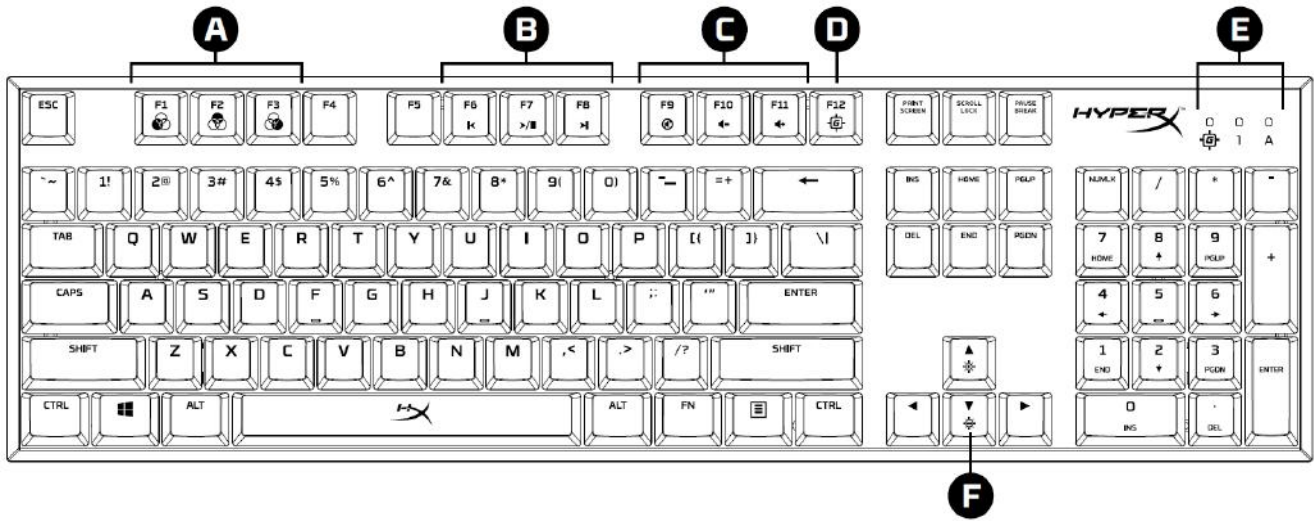





Keyboard Overview:





A- FN + F1, F2, F3 = Onboard memory profile selection.  +   

B- FN + F6, F7, F8 = Media control keys.  +   

C- FN + F9, F10, F11 = Volume control keys.  +   

D- FN + F12 Game Mode key.  + 

E- Game Mode / Num Lock / Caps Lock indicators.   

F- Up & Down = LED brightness control keys.  +  

G- Back USB port = Mobile phone USB charging port. 

H- Back mini USB port = Keyboard USB cable port. 



Keyboard Installation:

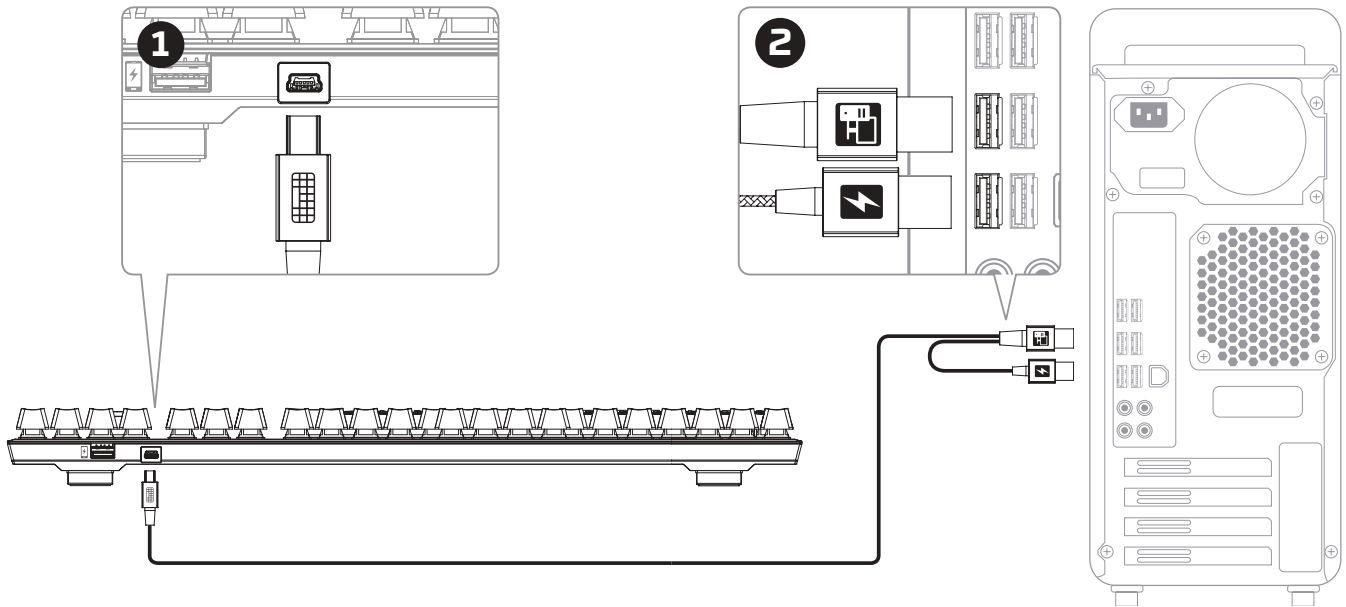

- 1- Connect the Mini USB connector to the keyboard.
- 2- Connect both USB connectors to the computer.



Function Keys:



Press “FN” and a function key at the same time to activate its secondary feature.

Function Keys	Secondary Feature
	<p>Switch between the profiles on the onboard memory.</p>
	<p>With the media keys you can play/pause ▶/ , skip backward ◀ or skip forward ▶ your music or video.</p>
	<p>With the volume control keys, you can mute 🔊, decrease 🔊- or increase 🔊+ your computer audio.</p>
	<p>Enabling Game Mode 🎮 will disable the Windows key to avoid any inconvenience during gaming. When Game Mode is enabled, the indicator will be illuminated.</p>
	<p>Increase ☀️ or decrease ☀️ the LED backlight brightness with these keys. There are 5 levels of brightness: 0%, 25%, 50%, 75%, 100%.</p>



HyperX NGenuity Software:



To customize lighting, Game Mode and macro settings, download the HyperX NGenuity software here: hyperxgaming.com/ngenuity.

Refer to the HyperX NGenuity Gaming Software manual for more information on functionalities.

Keyboard factory reset:

If you are experiencing any issue with the keyboard you can perform a factory reset. You will lose your custom LED profile by doing this **Keyboard factory reset**:

If you are experiencing any issue with the keyboard you can perform a factory reset. You will lose your custom LED profile by doing this.

Function Keys	Secondary Feature
 + 	Press both keys for 5 seconds until the keyboard backlight blinks.



Teclado mecánico para videojuegos HyperX Alloy FPS RGB



Números de pieza

HX-KB1SS2-US

HX-KB1SS2-UK

HX-KB1SS2-RU

HX-KB1SS2-NO

HX-KB1SS2-LA

HX-KB1SS2-FR

HX-KB1SS2-DE

**Elementos incluidos:**









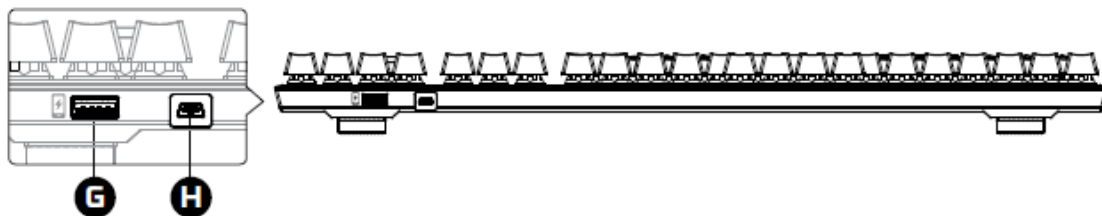
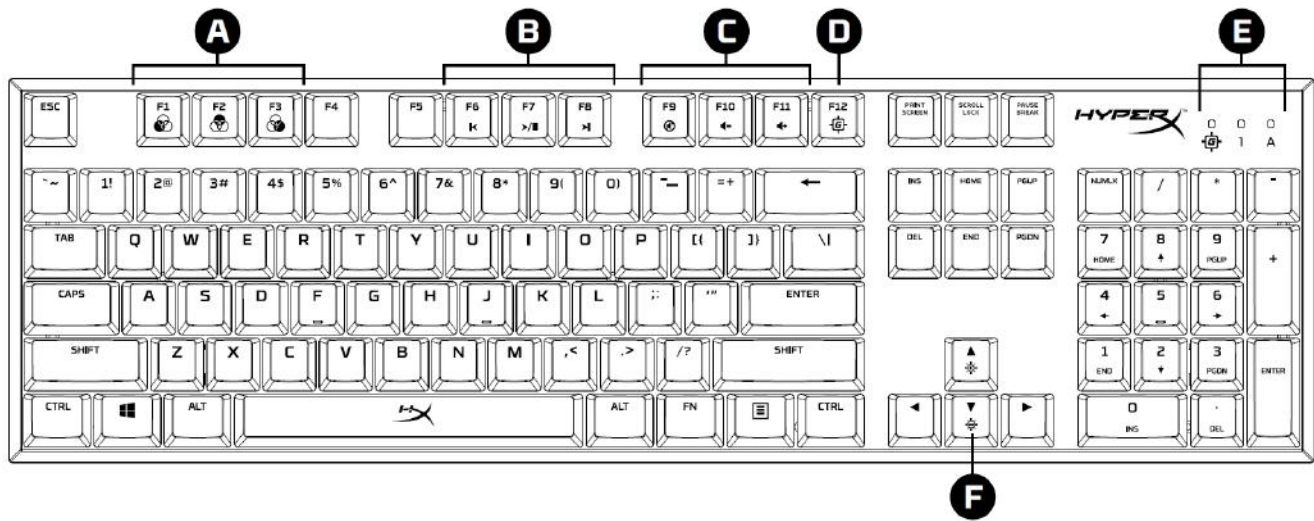













- Teclado mecánico para videojuegos HyperX Alloy FPS RGB
- Cable USB extraíble





Descripción general del teclado:



- A- FN + F1, F2, F3 = Selección del perfil de la memoria incorporada.  +   
- B- FN + F6, F7, F8 = Teclas de control multimedia.  +   
- C- FN + F9, F10, F11 = Teclas de control del volumen.  +   
- D- FN + F12 Tecla del modo Juego.  + 
- E- Indicadores de modo Juego/Bloq Num/Bloq Mayús.   
- F- Arriba y Abajo = Teclas de control de brillo LED.  +  
- G- Puerto USB posterior = Puerto de carga USB para teléfono móvil.  



H- Puerto mini USB posterior = Puerto de cable USB del teclado.

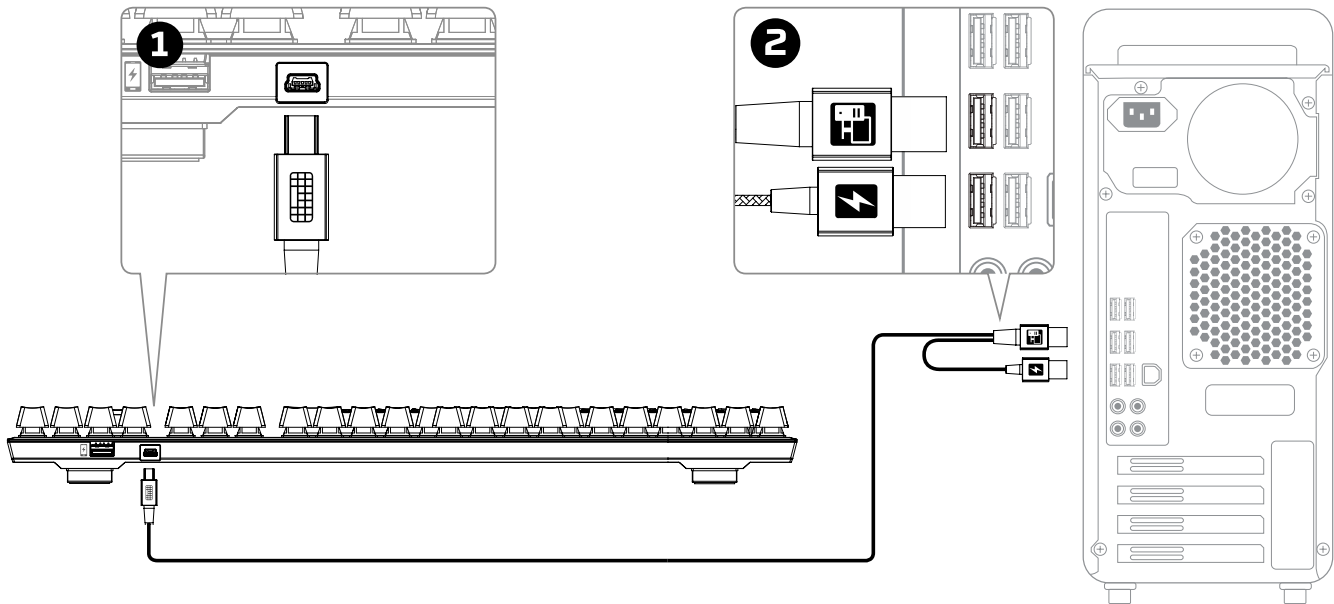

**Instalación del teclado:**

- 1- Conecta el conector mini USB al teclado.
- 2- Conecta ambos conectores USB al ordenador.



Teclas de función:



Pulsa "FN" y una tecla de función de manera simultánea para activar la función secundaria.

Teclas de función	Función secundaria
	<p>Cambia entre los perfiles de la memoria incorporada.</p>
	<p>Con las teclas multimedia puedes reproducir y pausar ▶/ , saltar hacia atrás ◀◀ o saltar hacia adelante ▶▶ la música o el vídeo.</p>
	<p>Con las teclas de control del volumen puedes silenciar 🔇, bajar 🔊- o subir 🔊+ el audio del ordenador.</p>
	<p>Al habilitar el modo Juego 🎮 se desactiva la tecla Windows para evitar inconvenientes durante el juego. Cuando se habilite el modo Juego se iluminará el indicador.</p>
	<p>Sube ☀️ o baja 🌑 el brillo de la retroiluminación LED con estas teclas. Existen cinco niveles de brillo: 0%, 25%, 50%, 75%, 100%.</p>



Software HyperX NGenuity:

Para personalizar la configuración de la macro, el modo Juego y la iluminación, descarga el software HyperX NGenuity aquí: hyperxgaming.com/ngenuity.

Consulta el manual del software de juegos HyperX NGenuity para obtener más información sobre las funcionalidades.

Restablecimiento de fábrica del teclado:

Si tienes algún problema con el teclado, puedes realizar un restablecimiento de fábrica. Perderás el perfil LED personalizado al realizar el **restablecimiento de fábrica del teclado**:

Si tienes algún problema con el teclado, puedes realizar un restablecimiento de fábrica. Al hacerlo perderás el perfil LED personalizado.

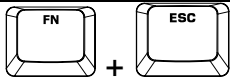
Teclas de función	Función secundaria
	Pulsa ambas teclas durante 5 segundos hasta que la retroiluminación del teclado parpadee.



HyperX Alloy FPS RGB Mechanische Gaming-Tastatur



Artikelnummern

HX-KB1SS2-US

HX-KB1SS2-UK

HX-KB1SS2-RU

HX-KB1SS2-NO

HX-KB1SS2-LA

HX-KB1SS2-FR

HX-KB1SS2-DE



Im Lieferumfang:





- HyperX Alloy FPS RGB Mechanische Gaming-Tastatur
- Abnehmbares USB-Kabel



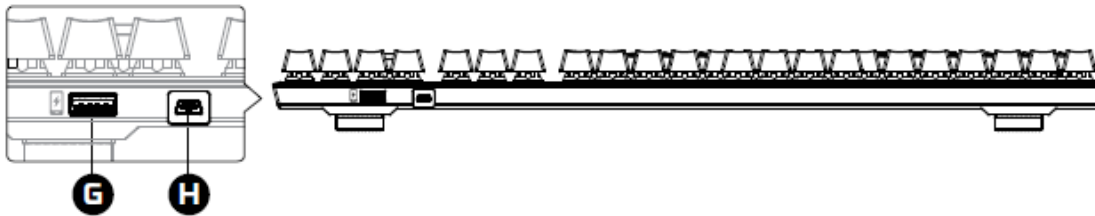
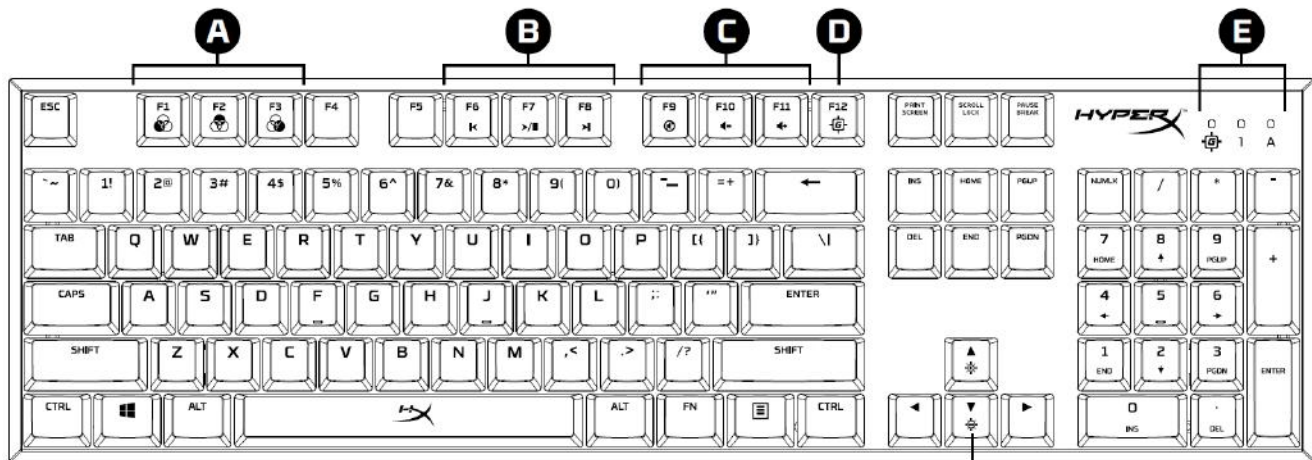

Tastenübersicht









A- FN + F1, F2, F3 = Profilauswahl im internen Speicher  +   



B- FN + F6, F7, F8 = Medientasten  +   

C- FN + F9, F10, F11 = Lautstärketasten  +   

D- FN + F12 Gaming-Modustaste  + 

E- Anzeige für Gaming-Modus / Num- / Feststelltaste   

F- Pfeil nach oben und unten = Tasten für LED-Helligkeit  +  

G- USB-Anschluss auf der Rückseite = Handy-USB-Ladeanschluss  

H- Mini-USB-Anschluss auf der Rückseite = USB-Anschluss für Tastaturkabel 



Installation der Tastatur:

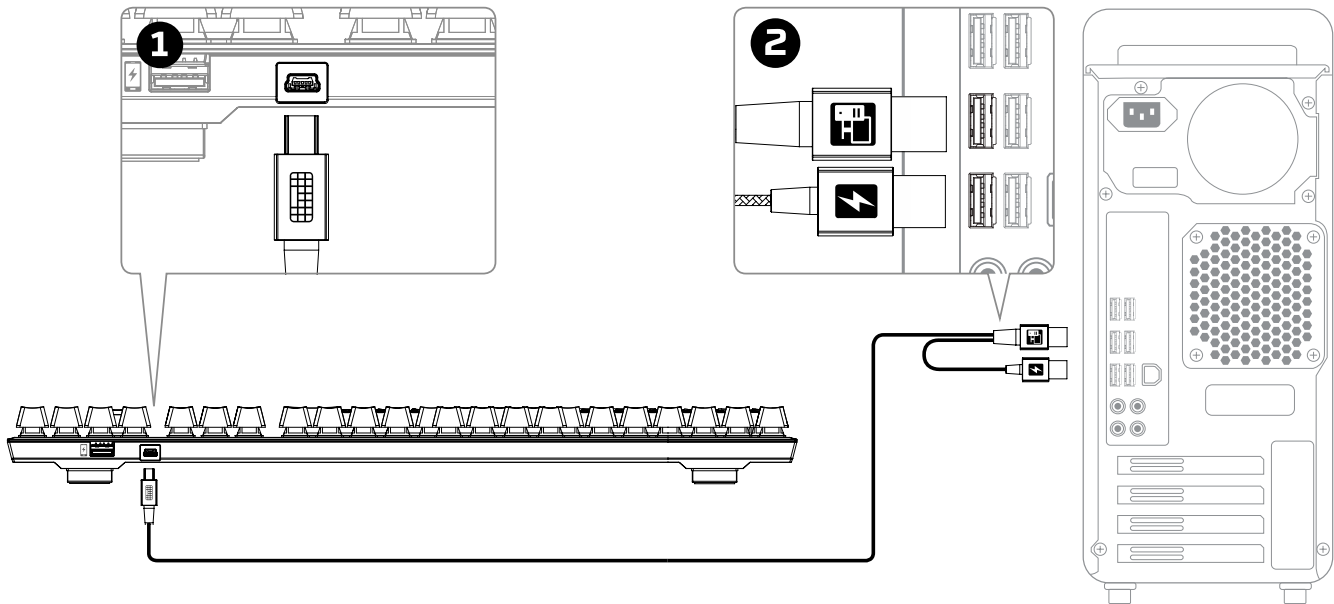

- 1- Verbinde den Mini-USB-Stecker mit der Tastatur.
- 2- Verbinde beide USB-Stecker mit dem Computer.



Funktionstasten:



Drücke gleichzeitig auf „FN“ und eine zweite Taste, um deren Zweitfunktion zu aktivieren.

Funktionstasten	Zweitfunktion
	<p>Wechsle zwischen den Profilen im internen Speicher.</p>
	<p>Mit den Medientasten kannst du Musik und Videos abspielen/pausieren ▶/ , im Musikstück oder Video rückwärts ◀ oder vorwärts springen ▶ .</p>
	<p>Mit den Lautstärketasten kannst du die Lautstärke des Computers stumm schalten, bzw. die Lautstärke erhöhen oder verringern .</p>
	<p>Wenn der Gaming-Modus aktiviert wird, wird die Windows-Taste deaktiviert, um den Komfort beim Spielen zu verbessern. Wenn der Gaming-Modus aktiviert ist, leuchtet die Anzeige.</p>
	<p>Erhöhe oder reduziere die LED-Hintergrundhelligkeit über diese Tasten. Es gibt 5 Helligkeitsstufen: 0%, 25%, 50%, 75%, 100%.</p>



HyperX NGenuity Software:



Um die Beleuchtung, den Gaming-Modus und die Macro-Einstellungen anzupassen, kannst du die HyperX NGenuity-Software hier herunterladen: hyperxgaming.com/ngenuity.

Weitere Infos über die verschiedenen Funktionen sind dem Handbuch zur HyperX NGenuity Gaming Software zu entnehmen.

Werkeinstellungen für Tastatur

Sollten Problem mit der Tastatur auftreten, kannst du sie auf die Werkeinstellungen zurücksetzen. Durch das Zurücksetzen auf die **Werkeinstellungen der Tastatur gehen deine individuellen LED-Einstellungen verloren:**

Sollten Problem mit der Tastatur auftreten, kannst du sie auf die Werkeinstellungen zurücksetzen. Dadurch gehen deine individuellen LED-Einstellungen verloren.

Funktionstasten	Zweitfunktion
 + 	Drücke beide Tasten 5 Sekunden lang, bis die Hintergrundbeleuchtung der Tastatur blinkt.



Clavier de jeu mécanique HyperX Alloy FPS RGB



Références produits

HX-KB1SS2-US

HX-KB1SS2-UK

HX-KB1SS2-RU

HX-KB1SS2-NO

HX-KB1SS2-LA

HX-KB1SS2-FR

HX-KB1SS2-DE



Le produit inclut :

- Clavier de jeu mécanique HyperX Alloy FPS RGB
- Câble USB amovible





Présentation du clavier :

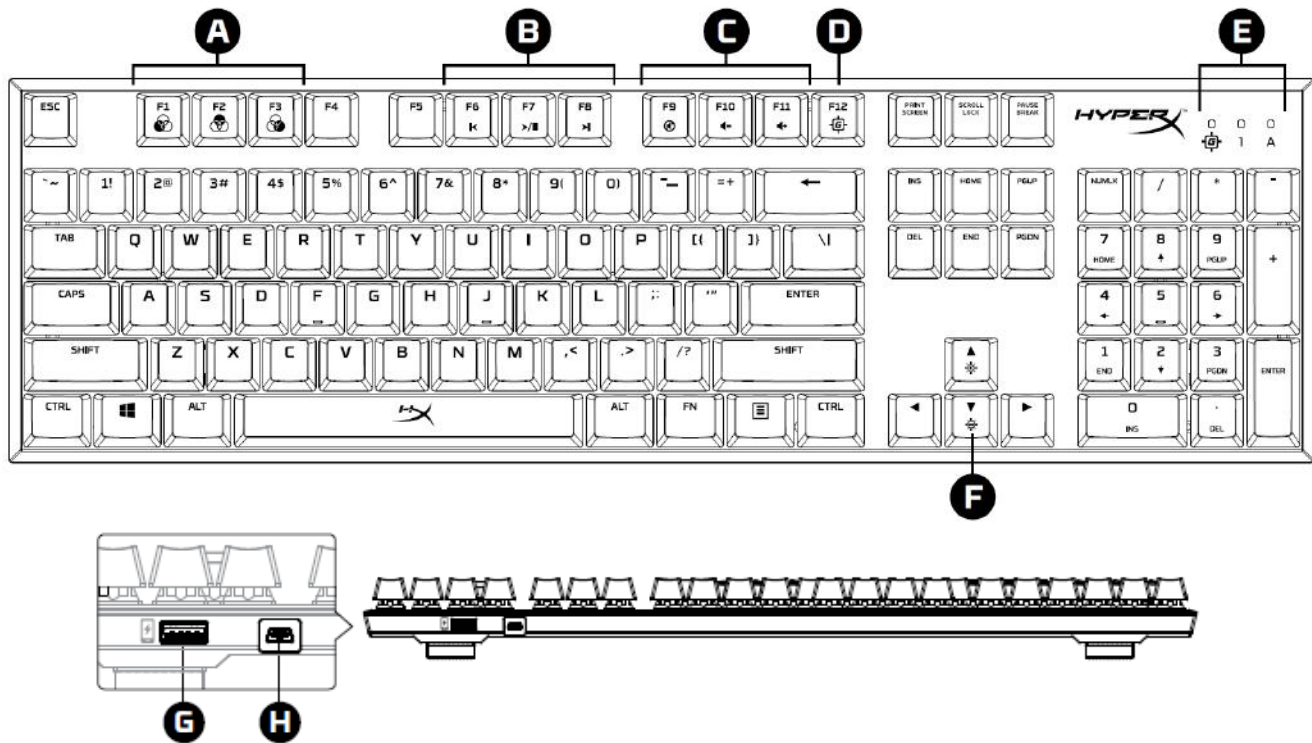

A- FN + F1, F2, F3 = Sélection des profils dans la mémoire embarquée.

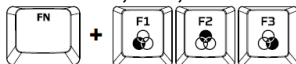

B- FN + F6, F7, F8 = Touches de contrôle des médias.



C- FN + F9, F10, F11 = Réglage du volume.



D- FN + F12 = Mode Jeu.

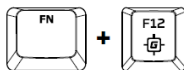

E- Témoins lumineux = Mode Jeu/ Verrouillage du clavier numérique/ Verrouillage des

Majuscules. 1 A

F- Haut & Bas = Réglage de la luminosité LED.



G- Port USB arrière = Chargement USB pour téléphone portable.





H- Port Mini USB arrière = Connexion du câble USB du clavier.





Installation du clavier :

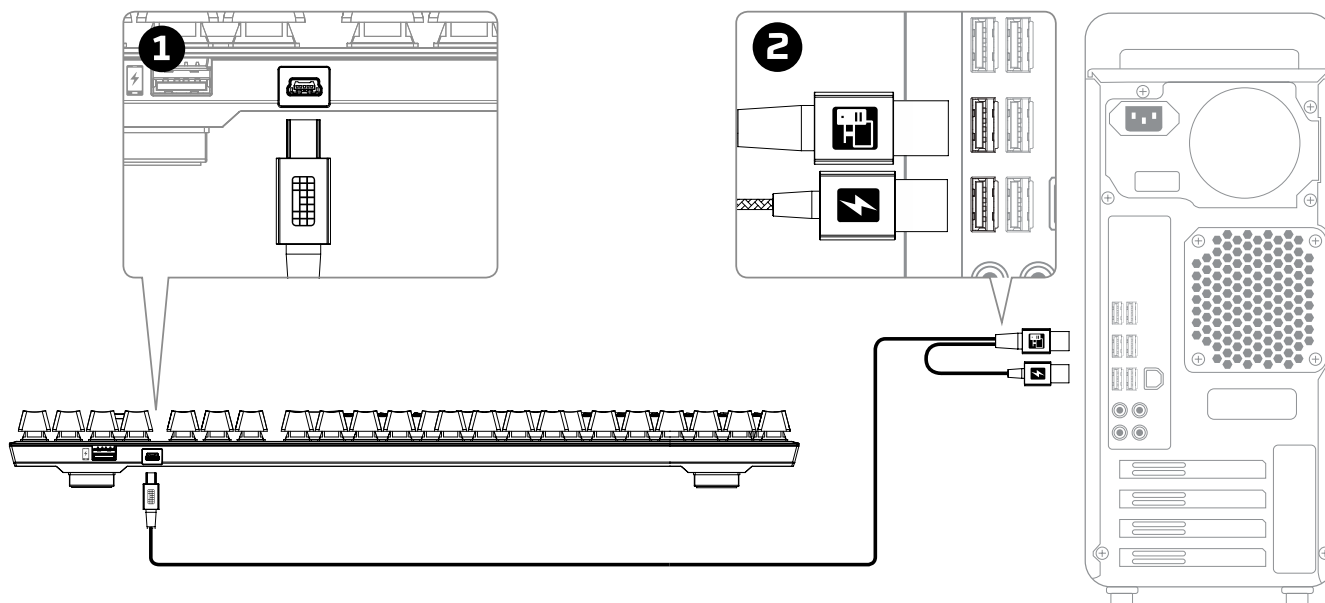

- 1- Branche le connecteur Mini USB au clavier.
- 2- Branche les deux connecteurs USB à l'ordinateur.



Touches de fonction :



Appuie en même temps sur la touche FN et sur une touche de fonction pour activer sa fonction secondaire.

Touches de fonction	Fonction secondaire
	<p>Sélectionne un des profils - enregistrés dans la mémoire embarquée.</p>
	<p>Les touches Médias servent aussi de touches Lecture/ Pause ▶/ , Retour rapide ◀ ou Avance rapide ▶ sur les fichiers audio ou vidéo.</p>
	<p>Avec les touches de réglage du volume, tu peux couper 🔊, baisser 🔊- ou augmenter 🔊+ le volume audio de ton ordinateur.</p>
	<p>L'activation du mode Jeu 🎮 désactive la touche Windows et évite des interruptions accidentelles en cours de partie. Lorsque le mode Jeu est activé, le voyant est allumé.</p>
	<p>Augmente ☀️ ou diminue ☹️ la luminosité du rétroéclairage LED. Cinq niveaux de luminosité : 0%, 25%, 50%, 75%, 100%.</p>



Logiciel HyperX NGenuity :

Pour personnaliser l'éclairage, le mode Jeu, les paramètres Macro, télécharge le logiciel HyperX NGenuity ici : hyperxgaming.com/ngenuity.

Pour obtenir d'autres informations sur les fonctions, consulte le manuel du logiciel HyperX NGenuity Gaming.

Réinitialisation d'usine :

En cas de problème pendant l'utilisation du clavier, il peut être réinitialisé pour rétablir sa configuration d'usine. Cette réinitialisation du clavier **efface tous les paramètres de personnalisation LED** :

En cas de problème pendant l'utilisation du clavier, il peut être réinitialisé pour rétablir sa configuration d'usine. Cette réinitialisation efface tous les paramètres de personnalisation LED.

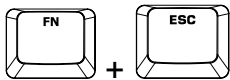
Touches de fonction	Fonction secondaire
	Maintient les deux touches enfoncées pendant 5 secondes jusqu'à ce que le rétroéclairage du clavier clignote.



Tastiera meccanica per il gaming HyperX Alloy FPS RGB



Numeri di parte

HX-KB1SS2-US

HX-KB1SS2-UK

HX-KB1SS2-RU

HX-KB1SS2-NO

HX-KB1SS2-LA

HX-KB1SS2-FR

HX-KB1SS2-DE

**Contenuto della confezione:**

- Tastiera meccanica per il gaming HyperX Alloy FPS RGB
- Cavo USB scollegabile





Descrizione generale della tastiera:

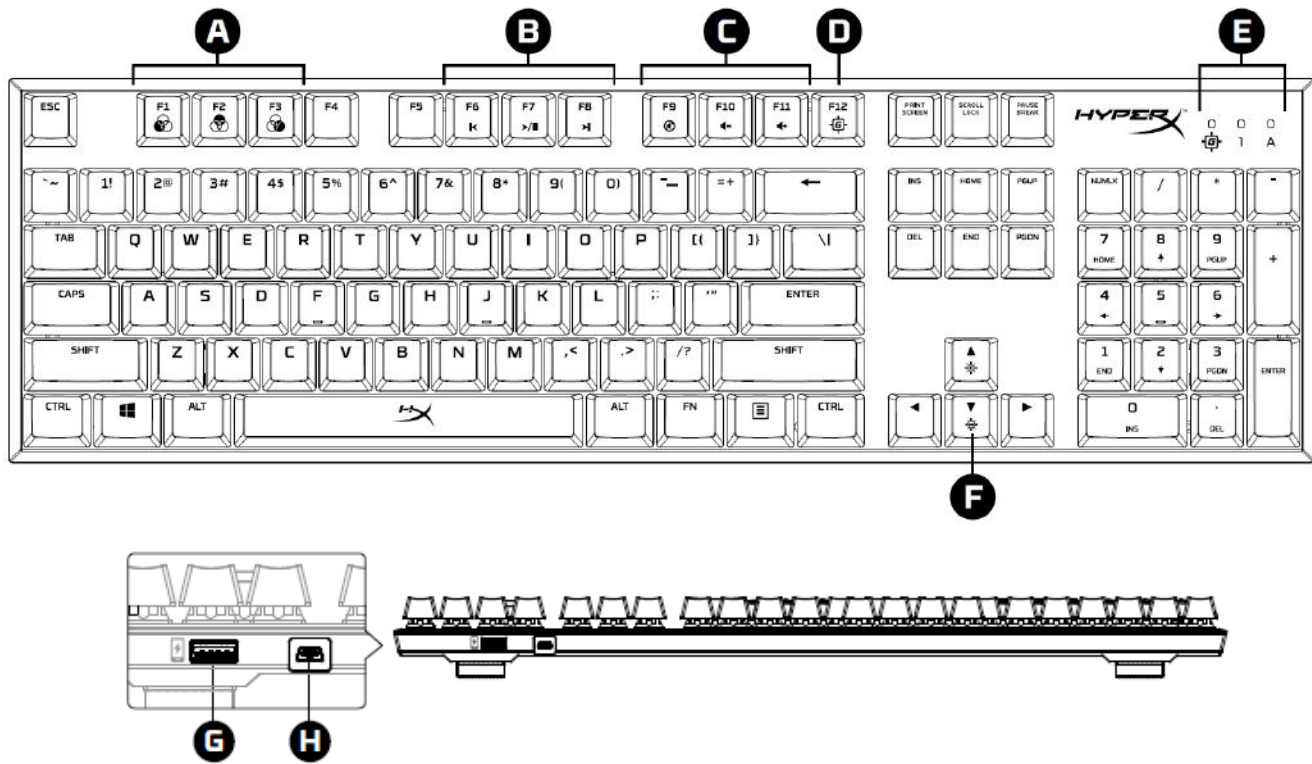

A- FN + F1, F2, F3 = Scelta dei profili salvati nella memoria integrata. +

B- FN + F6, F7, F8 = Tasti di controllo multimediali. +

C- FN + F9, F10, F11 = Tasti per la regolazione del volume. +

D- FN + F12 Tasti modalità Game. +

E- Indicatori Modalità Game / Bloc Num / Bloc Maiusc.

F- Su / Giù = tasti di regolazione luminosità LED. +

G- Porta USB posteriore = porta USB per la ricarica di smartphone.

H- Porta mini USB posteriore = porta per il cavo USB della tastiera.

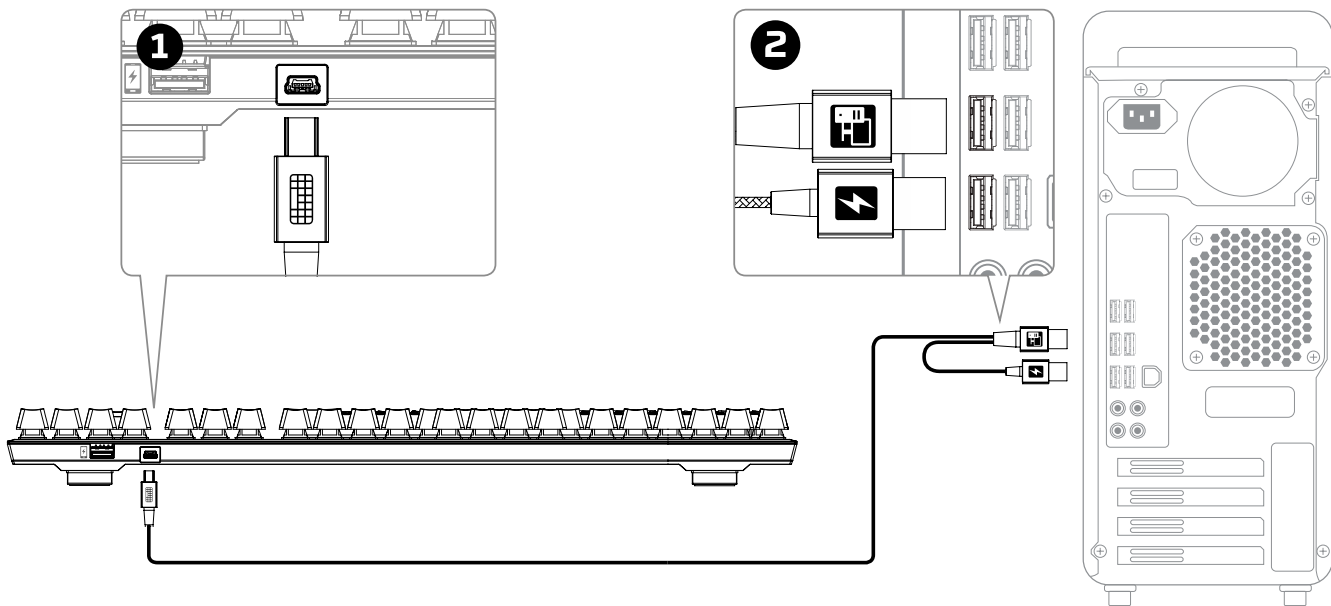
**Installazione rapida:**

- 1- Inserire il connettore mini USB nella tastiera.
- 2- Inserire entrambi i connettori USB nel computer.



Tasti funzione:



Premere il tasto "FN" contemporaneamente a uno dei tasti funzione per attivarne la funzionalità prevista.

Tasti funzione	Funzionalità secondaria
	<p>Consente di alternare i profili; li salvati nella memoria integrata.</p>
	<p>I tasti multimediali prevedono le funzioni play/pausa ▶/ , consente di passare alla traccia precedente ◀ o a quella successiva ▶ durante la riproduzione di musica o video.</p>
	<p>I tasti di regolazione del volume includono la funzione di silenziamento 🔇, riduzione 🔊- o aumento 🔊+ per l'audio del computer.</p>
	<p>L'attivazione della modalità Game 🎮 disabilita il tasto Windows per evitare ogni inconveniente durante il gioco. L'indicatore si illumina quando la modalità Game è attivata.</p>
	<p>Questi tasti consentono di aumentare 🔆 o ridurre 🔆 la luminosità della retroilluminazione LED. Sono previsti 5 livelli di luminosità: 0%, 25%, 50%, 75%, 100%.</p>



Software HyperX NGenuity:

Per personalizzare illuminazione, modalità Game e impostazioni macro scaricare il software HyperX NGenuity al seguente indirizzo: hyperxgaming.com/ngenuity.

Per ulteriori informazioni sugli utilizzi indicati, consultare il Manuale d'uso del software per gaming HyperX NGenuity.

Ripristino opzioni di fabbrica:

Nel caso si verificano problemi nell'utilizzo della tastiera, è possibile ripristinare le opzioni di fabbrica. Eseguendo il **Ripristino alle impostazioni di fabbrica**, *tutte le impostazioni di personalizzazione del profilo LED saranno eliminate.*

Nel caso si verificano problemi nell'utilizzo della tastiera, è possibile ripristinare le opzioni di fabbrica. In questo caso tutte le impostazioni di personalizzazione del profilo LED saranno eliminate.

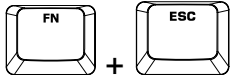
Tasti funzione	Funzionalità secondaria
	Premere entrambi i tasti per 5 secondi fino a quando la retroilluminazione della tastiera inizia a lampeggiare.



HyperX Alloy FPS RGB Mechanical Gaming Keyboard



Código do Produto
HX-KB1SS2-US
HX-KB1SS2-UK
HX-KB1SS2-RU
HX-KB1SS2-NO
HX-KB1SS2-LA
HX-KB1SS2-FR
HX-KB1SS2-DE



O que está incluído:

- Teclado Mecânico Gamer HyperX Alloy FPS RGB
- Cabo USB removível





Visão Geral do teclado:

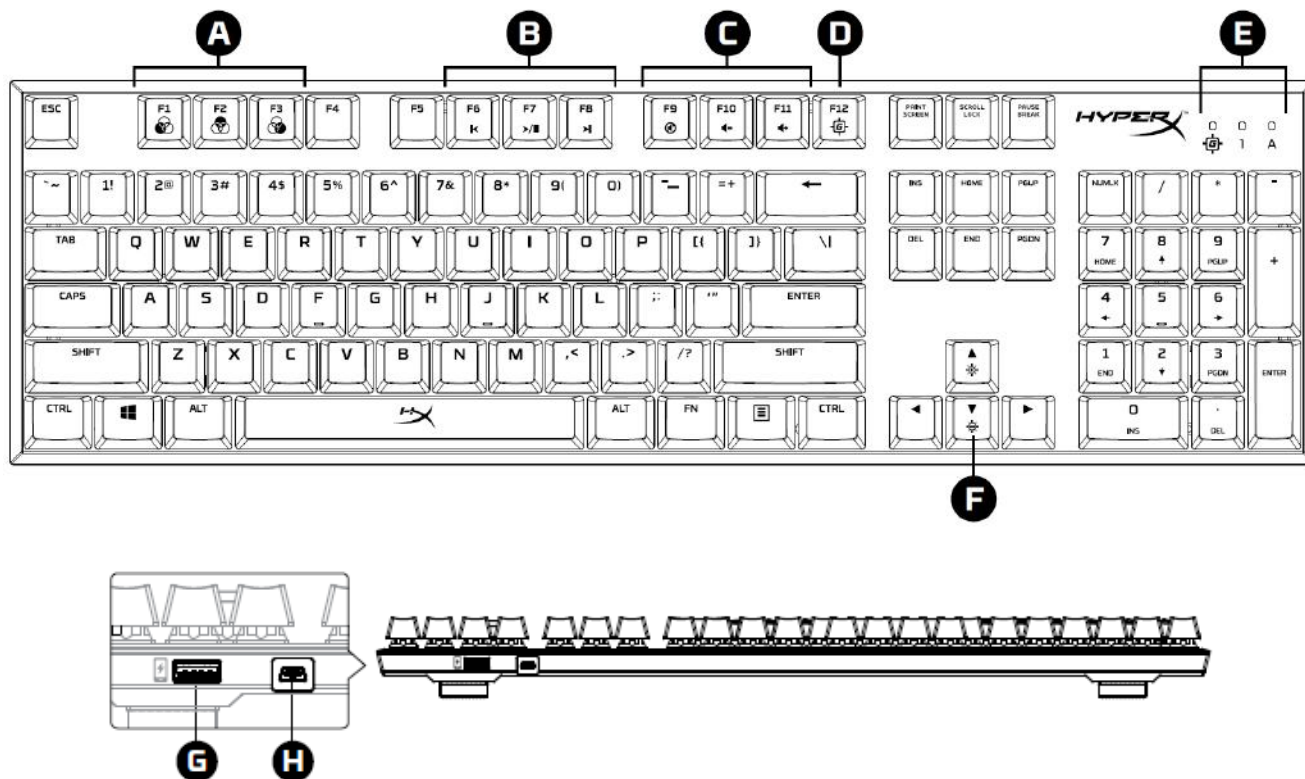

A- FN + F1, F2, F3 = Seleção de perfis da memória integrada.

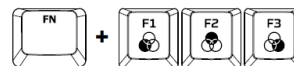

B- FN + F6, F7, F8 = Teclas de controle de mídia.

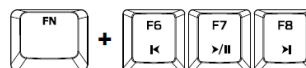

C- FN + F9, F10, F11 = Teclas de controle de volume.



D- FN + F12 Tecla de modo jogo.

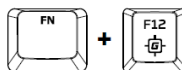

E- Indicadores Modo jogo / Num Lock / Caps Lock.

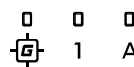

F- Setas para cima e para baixo = teclas de controle de brilho do LED.

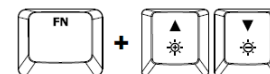

G- Porta USB = Porta USB de carregamento de celular.

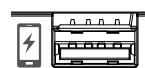



H- Porta Mini USB = Porta do cabo USB do teclado.

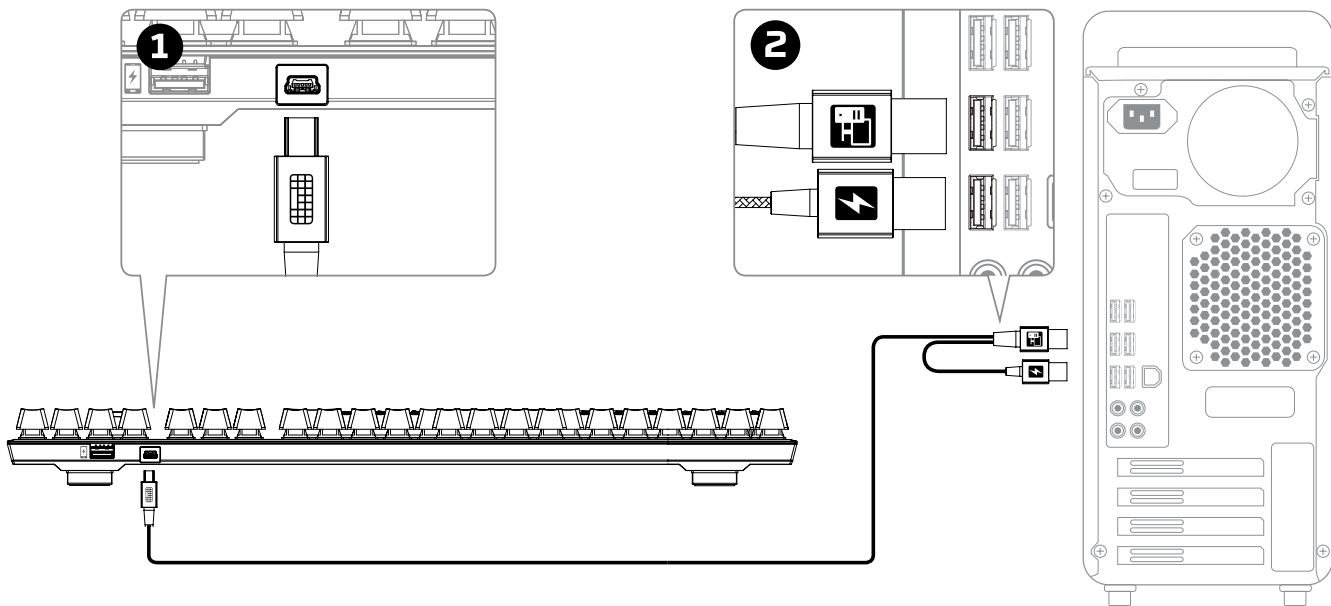

**Instalação do teclado:**

- 1- Conecte o conector Mini USB ao teclado.
- 2- Conecte ambos os conectores USB ao computador.



Teclas de função:



Pressione “FN” e uma tecla de função ao mesmo tempo para ativar seu recurso secundário.

Teclas de função	Recurso secundário
	<p>Altere entre os perfis da memória integrada.</p>
	<p>Com as teclas de mídia você pode reproduzir/pausar ▶/ , voltar ◀ ou avançar ▶ sua música ou vídeo.</p>
	<p>Com as teclas de controle de volume, você pode colocar em mudo 🔇, diminuir 🔊- ou aumentar 🔊+ o áudio do seu computador.</p>
	<p>Ativar o Modo Jogo 🎮 irá desativar a tecla Windows para evitar qualquer inconveniente durante o jogo. Quando o Modo Jogo estiver ativado, o indicador ficará iluminado.</p>
	<p>Aumente ☀️ ou diminua ☹️ o brilho do backlight do LED com essas teclas. Há 5 níveis de brilho: 0%, 25%, 50%, 75%, 100%.</p>



Software HyperX NGenuity:

Para personalizar as configurações de iluminação, Modo Jogo e macro, faça o download do software HyperX NGenuity aqui: hyperxgaming.com/ngenuity.

Consulte o manual do software HyperX NGenuity Gaming para mais informações sobre as funcionalidades.

Voltar o teclado às configurações de fábrica:

Se está tendo algum problema com o teclado você pode voltar às configurações de fábrica. Ao fazer isso você perderá seu perfil de LED personalizado. **Voltar o teclado às configurações de fábrica:**

Se está tendo algum problema com o teclado você pode voltar às configurações de fábrica. Ao fazer isso você perderá seu perfil de LED personalizado.

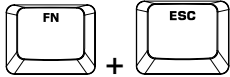
Teclas de função	Recurso secundário
	Pressione ambas as teclas por 5 segundos até o backlight do teclado piscar.



Mechaniczna klawiatura dla graczy HyperX Alloy FPS RGB



Numery katalogowe

HX-KB1SS2-US

HX-KB1SS2-UK

HX-KB1SS2-RU

HX-KB1SS2-NO

HX-KB1SS2-LA

HX-KB1SS2-FR

HX-KB1SS2-DE

**Zawartość zestawu:**

- Mechaniczna klawiatura dla graczy HyperX Alloy FPS RGB
- Odłączany przewód USB





Opis klawiatury:

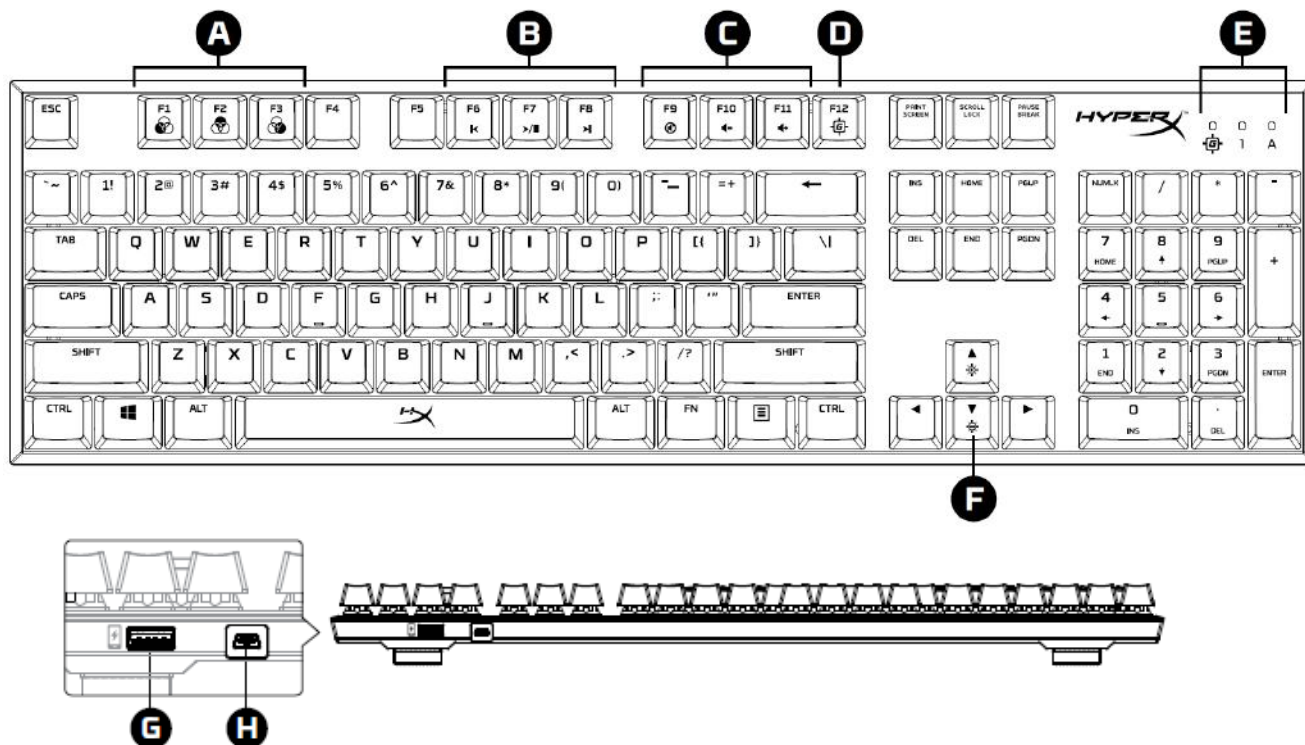

A- FN + F1, F2, F3 = wybór profilu zapisanego we wbudowanej pamięci



B- FN + F6, F7, F8 = klawisze sterowania multimediami

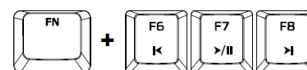

C- FN + F9, F10, F11 = klawisze sterowania głośnością



D- FN + F12 = klawisz trybu gry

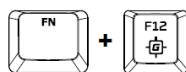

E- Wskaźniki włączonego trybu gry / Num Lock / Caps Lock

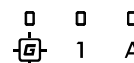

F- Strzałki w górę i w dół = klawisze sterowanie jasnością podświetlenia LED

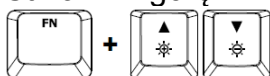

G- Tylny port USB = port USB do ładowania telefonu



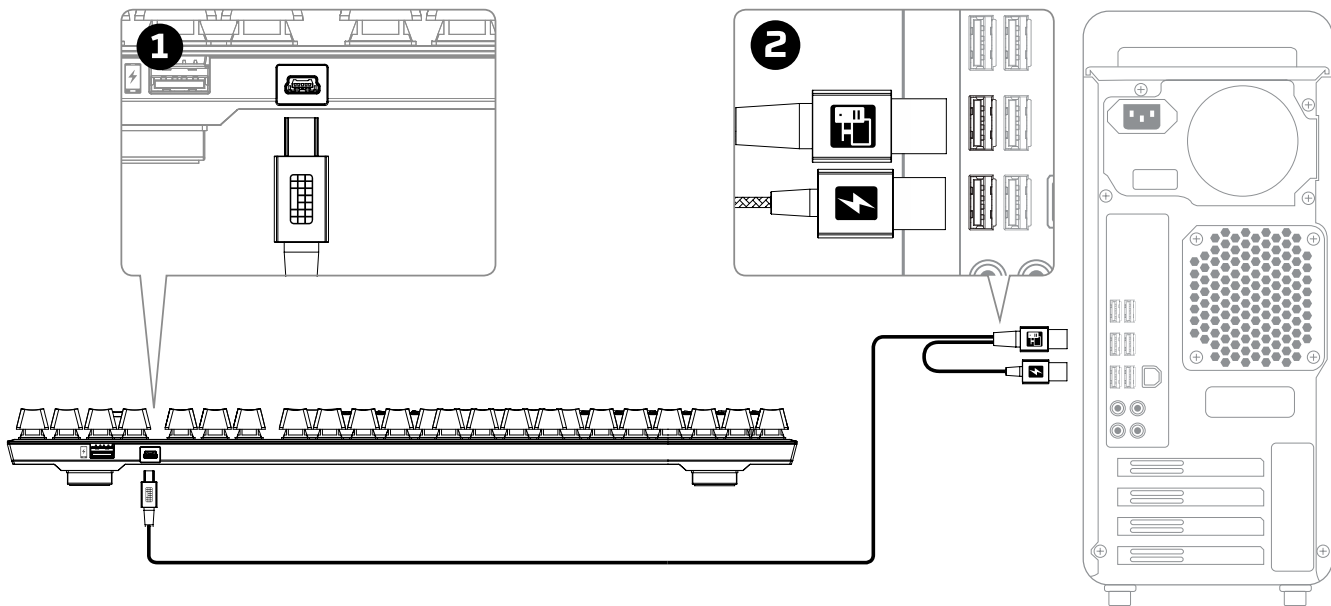

H- Tylny port mini USB = port przewodu USB klawiatury 

**Instalacja klawiatury:**

- 1- Podłącz wtyk mini USB do klawiatury.
- 2- Podłącz oba wtyki USB do komputera.



Klawisze funkcyjne:



Naciśnij jednocześnie klawisz FN i klawisz funkcyjny, aby aktywować jego dodatkową funkcję.

Klawisze funkcyjne	Funkcja dodatkowa
	<p>Przełączanie się między profilami zapisanymi we wbudowanej pamięci.</p>
	<p>Klawisze sterowania multimediami umożliwiają uruchamianie i wstrzymywanie odtwarzania muzyki lub filmu ▶/ oraz przewijanie do przodu ◀◀ i do tyłu ▶▶.</p>
	<p>Klawisze sterowania głośnością umożliwiają wyciszenie dźwięku w komputerze 🔇 oraz zmniejszanie 🔊- i zwiększanie 🔊+ głośności dźwięku.</p>
	<p>Włączenie trybu gry 🎮 powoduje wyłączenie klawisza Windows, aby jego przypadkowe naciśnięcie nie przerywało gry. Gdy tryb gry jest włączony, wskaźnik świeci.</p>
	<p>Za pomocą tych klawiszy można zwiększyć 🔆 lub zmniejszyć 🔆 jasność podświetlenia LED. Dostępnych jest pięć poziomów jasności podświetlenia: 0%, 25%, 50%, 75%, 100%.</p>



Oprogramowanie HyperX NGenuity:

Aby dostosować podświetlenie, tryb gry i ustawienia makr, pobierz oprogramowanie HyperX NGenuity ze strony: hyperxgaming.com/ngenuity.

Więcej informacji na temat funkcji oprogramowania dla graczy HyperX NGenuity można znaleźć w podręczniku użytkownika tego programu.

Przywracanie fabrycznych ustawień klawiatury:

W przypadku wystąpienia jakichkolwiek problemów z klawiaturą można przywrócić jej ustawienia fabryczne. **Przywrócenie ustawień fabrycznych** spowoduje usunięcie skonfigurowanego profilu podświetlenia LED.

W przypadku wystąpienia jakichkolwiek problemów z klawiaturą można przywrócić jej ustawienia fabryczne. Spowoduje to usunięcie skonfigurowanego profilu podświetlenia LED.

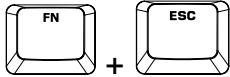
Klawisze funkcyjne	Funkcja dodatkowa
	Naciśnij i przytrzymaj oba klawisze przez 5 sekund, aż podświetlenie klawiatury mignie.



Механическая геймерская клавиатура HyperX Alloy FPS RGB



Номера по каталогу

HX-KB1SS2-US

HX-KB1SS2-UK

HX-KB1SS2-RU

HX-KB1SS2-NO

HX-KB1SS2-LA

HX-KB1SS2-FR

HX-KB1SS2-DE

**Комплект поставки:**

- Механическая игровая клавиатура
HyperX Alloy FPS RGB
- Съёмный USB-кабель





Обзор клавиатуры:

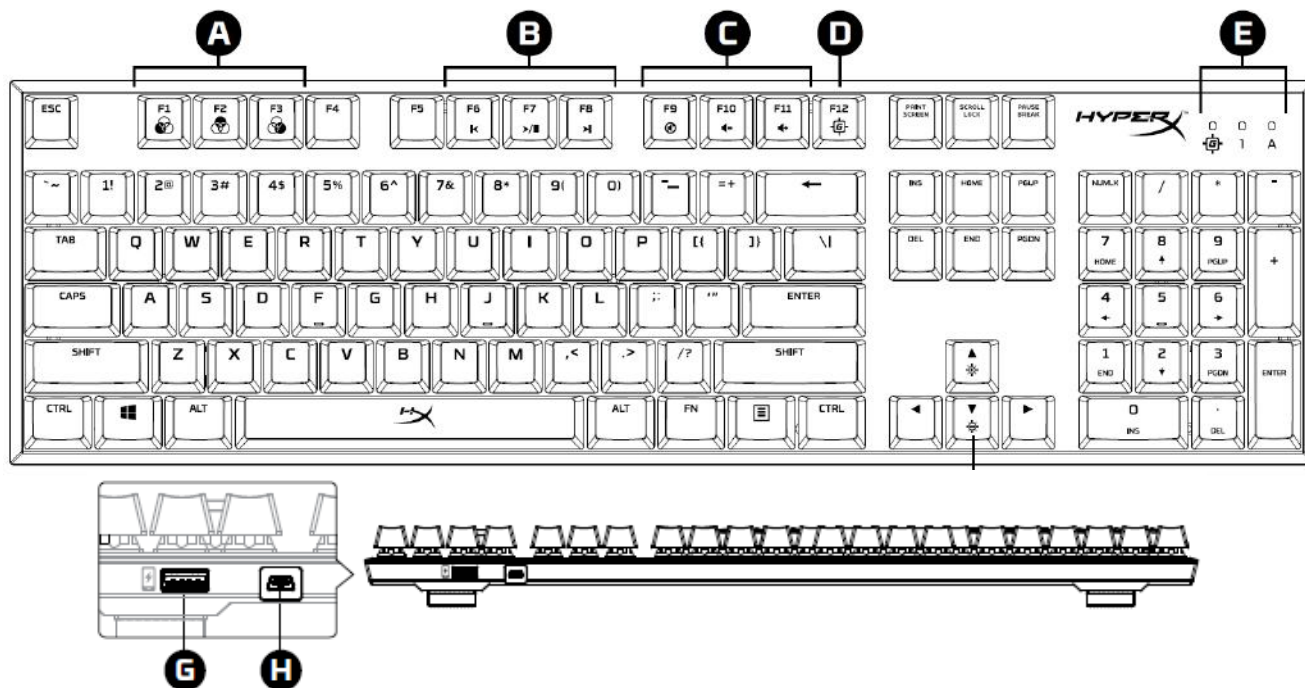



A- FN + F1, F2, F3 = Выбор профилей встроенной памяти.  +   

B- FN + F6, F7, F8 = Мультимедийные клавиши.  +   



C- FN+ F9, F10, F11 = Клавиши регулировки громкости  +   

D- FN + F12 = Клавиша игрового режима.  + 

E- Индикаторы игрового режима/Num Lock/Caps Lock.   

F- Стрелки вверх и вниз = Клавиши регулировки яркости светодиодов.



G- Задний порт USB = USB-порт для зарядки мобильных телефонов.  

H- Порт мини-USB сзади = Порт для USB-кабеля клавиатуры. 



Установка клавиатуры:

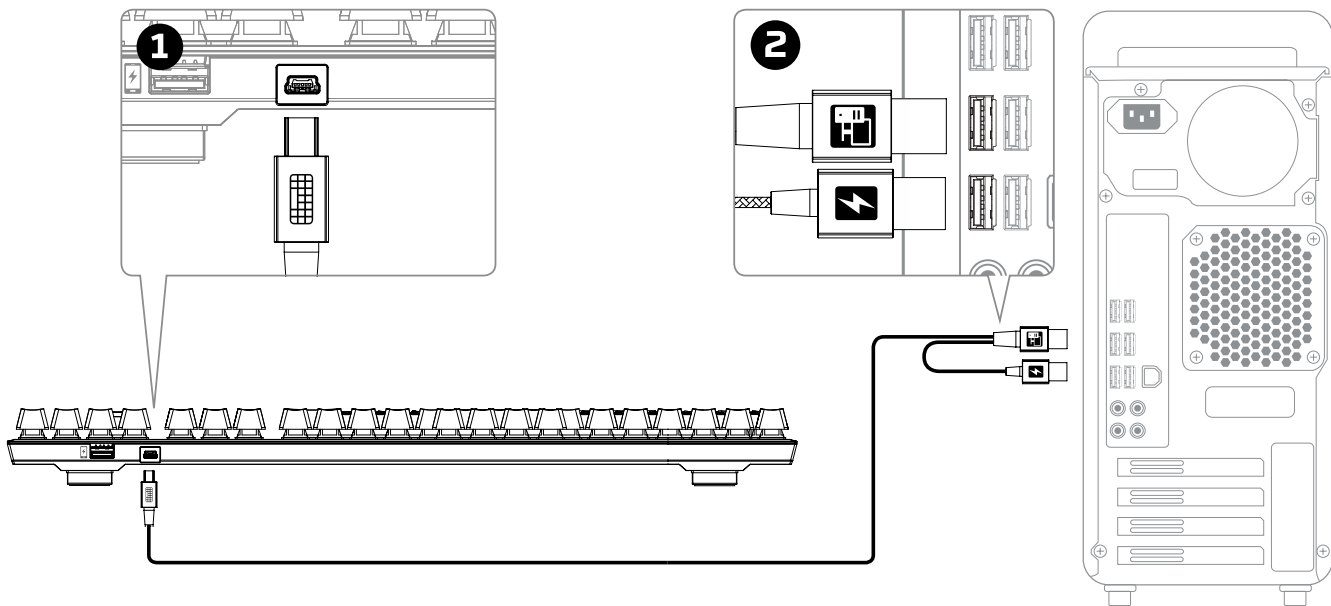

- 1- Подсоедините разъем mini-USB к клавиатуре.
- 2- Подсоедините оба разъема USB к компьютеру.



Функциональные клавиши:



Для активации вспомогательной функции одновременно нажмите FN и функциональную клавишу.

Функциональные клавиши	Вспомогательная функция
	<p>Переключение между профилями встроенной памяти.</p>
	<p>С помощью мультимедийных клавиш могут выполняться воспроизведение/пауза ►/ , а также прокрутка назад ◀ или прокрутка вперед ▶ музыки или видео.</p>
	<p>С помощью клавиш регулировки громкости вы можете выключать звук 🔊, а также уменьшать 🔊- или увеличивать 🔊+ громкость звука на компьютере.</p>
	<p>Включение игрового режима 🎮 позволит отключить клавишу Windows, чтобы во время игры не возникало никаких неудобств. При включении игрового режима загорается индикатор.</p>
	<p>С помощью этих клавиш вы можете увеличивать ☀️ или уменьшать ☀️ яркость светодиодной подсветки. Имеется 5 уровней яркости: 0%, 25%, 50%, 75%, 100%.</p>



ПО HyperX NGenuity:

Для настройки подсветки, игрового режима и макросов скачайте ПО HyperX NGenuity здесь: hyperxgaming.com/ngenuity.



См. дополнительную информацию о функциях в Руководстве по гейминговому ПО HyperX NGenuity.

Сброс к заводским настройкам:

При возникновении каких-либо проблем с клавиатурой вы можете вернуться к заводским настройкам. При этом вы потеряете свой индивидуальный профиль светодиодной подсветки

Сброс к заводским настройкам:

При возникновении каких-либо проблем с клавиатурой вы можете вернуться к заводским настройкам. При этом вы потеряете свой индивидуальный светодиодный профиль.

Функциональные клавиши	Вспомогательная функция
 + 	Нажмите обе клавиши на 5 секунд, пока подсветка клавиатуры не начнет мигать.



HyperX Alloy FPS RGB Mekanik Oyun Klavyesi



Parça Numaraları

HX-KB1SS2-US

HX-KB1SS2-UK

HX-KB1SS2-RU

HX-KB1SS2-NO

HX-KB1SS2-LA

HX-KB1SS2-FR

HX-KB1SS2-DE

**Paketin iindekiler:**

- HyperX Alloy FPS RGB Mekanik Oyun Klavyesi
- ıkarılabilir USB kablosu





Klavyeye Genel Bakış:

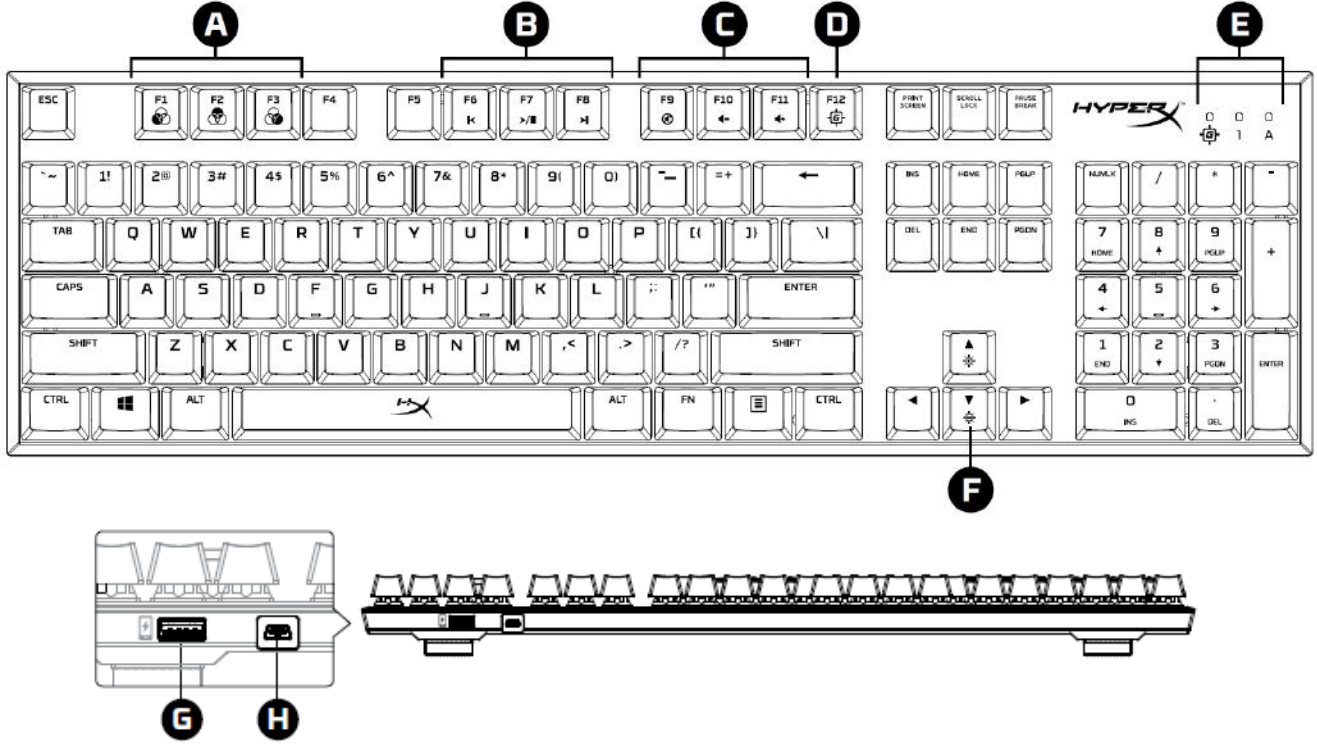

A- FN + F1, F2, F3 = Yerleşik bellekteki profil seçimi.



B- FN + F6, F7, F8 = Medya kontrol tuşları.

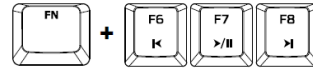

C- FN + F9, F10, F11 = Ses kontrol tuşları.

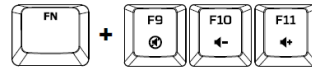

D- FN + F12 = Oyun Modu tuşu.

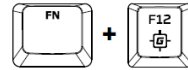

E- Oyun Modu / Num Lock / Caps Lock göstergeleri.

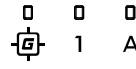

F- Yukarı - Aşağı = LED parlaklığı kontrol tuşları.

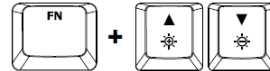

G- Arka USB bağlantı noktası = Cep telefonu USB şarj bağlantı noktası.

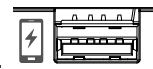

H- Arka mini USB bağlantı noktası = Klavye USB kablosu bağlantı noktası.





Klavye Kurulumu:

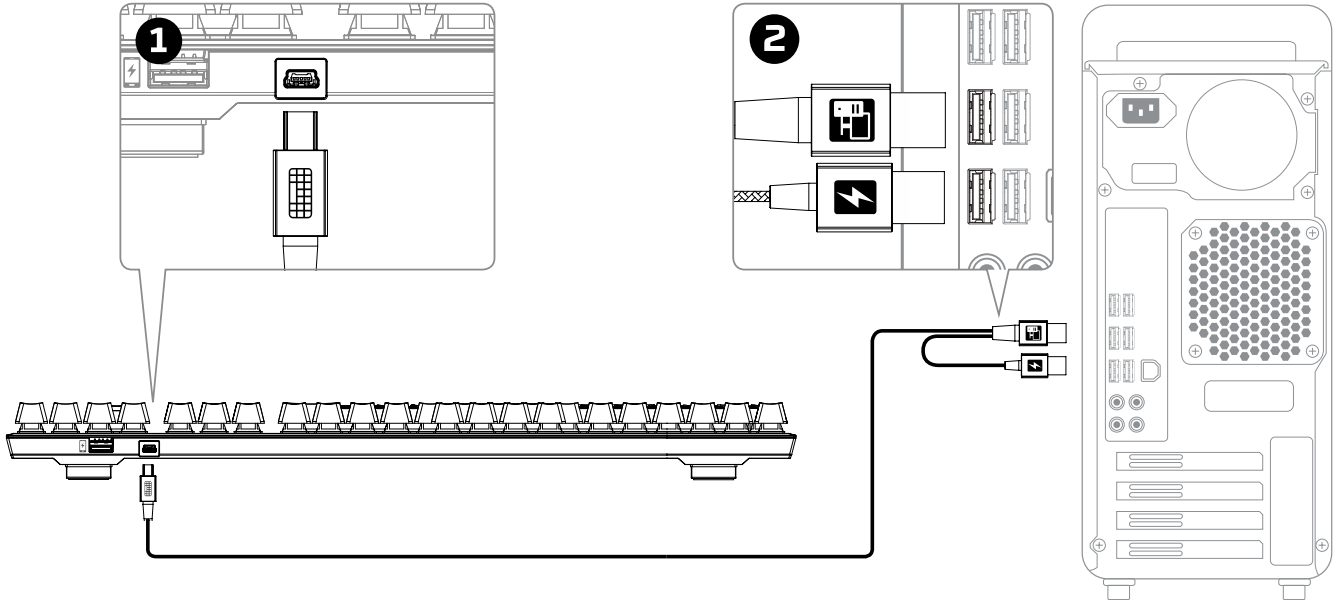

- 1- Mini USB konnektörünü klavyeye bağlayın.
- 2- Her iki USB konnektörünü bilgisayara bağlayın.



Fonksiyon Tuşları:



Bir fonksiyon tuşunun ikincil özelliğini etkinleştirmek için, "FN" tuşu ile aynı anda ilgili fonksiyon tuşuna basın.

Fonksiyon Tuşları	İkincil Özellik
	<p>Yerleşik bellekteki profiller arasında geçiş yapma.</p>
	<p>Medya tuşları ile, müzik veya videolarınızı oynatabilir/duraklatabilir ►/ , geri alabilir ◀ veya ileri alabilirsiniz ▶ .</p>
	<p>Ses kontrol tuşları ile, bilgisayarınızın sesini sessize alabilir 🔊, sesini azaltabilir 🔊- veya arttırabilirsiniz 🔊+.</p>
	<p>Oyun Modu'nu etkinleştirdiğinizde 🎮 Windows tuşu, oyun sırasında oluşabilecek herhangi bir rahatsızlığı önler. Oyun Modu etkinleştirildiğinde, gösterge yanar.</p>
	<p>LED arka ışık parlaklığını bu düğmelerle artırın ☀️ veya azaltın ☀️. 5 parlaklık seviyesi bulunur: 0%, 25%, 50%, 75%, 100%.</p>



HyperX NGenuity Yazılımı:

Aydınlatma özelliklerini, Oyun Modu ve makro ayarlarını kişiselleştirmenizi sağlayan HyperX NGenuity yazılımını buradan indirebilirsiniz: hyperxgaming.com/ngenuity.

İşlevler hakkında daha fazla bilgi edinmek için HyperX NGenuity Oyun Yazılımı kullanım kılavuzunu inceleyin.

Klavye fabrika ayarlarına sıfırlama:

Klavye ile ilgili bir sorun yaşıyorsanız, fabrika ayarlarına sıfırlama işlemi gerçekleştirebilirsiniz. Bu işlem, özel LED profilinizin silinmesine neden olur. **Klavye fabrika ayarlarına sıfırlama:**

Klavye ile ilgili bir sorun yaşıyorsanız, fabrika ayarlarına sıfırlama işlemi gerçekleştirebilirsiniz. Bu işlem, özel LED profilinizin silinmesine neden olur.

Fonksiyon Tuşları	İkincil Özellik
	Klavye arka ışığı yanıp sönene kadar, her iki tuşa 5 saniye basın.



HyperX Alloy FPS RGB メカニカルゲーミングキーボード



製品番号

HX-KB1SS2-US

HX-KB1SS2-UK

HX-KB1SS2-RU

HX-KB1SS2-NO

HX-KB1SS2-LA

HX-KB1SS2-FR

HX-KB1SS2-DE



パッケージ内容:





- HyperX Alloy FPS RGB メカニカルゲーミングキーボード
- 取り外し可能な USB ケーブル



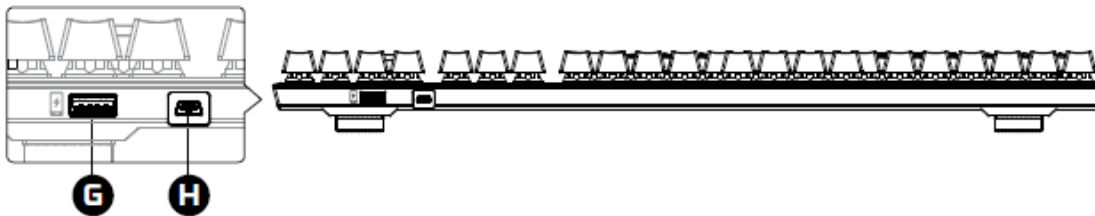
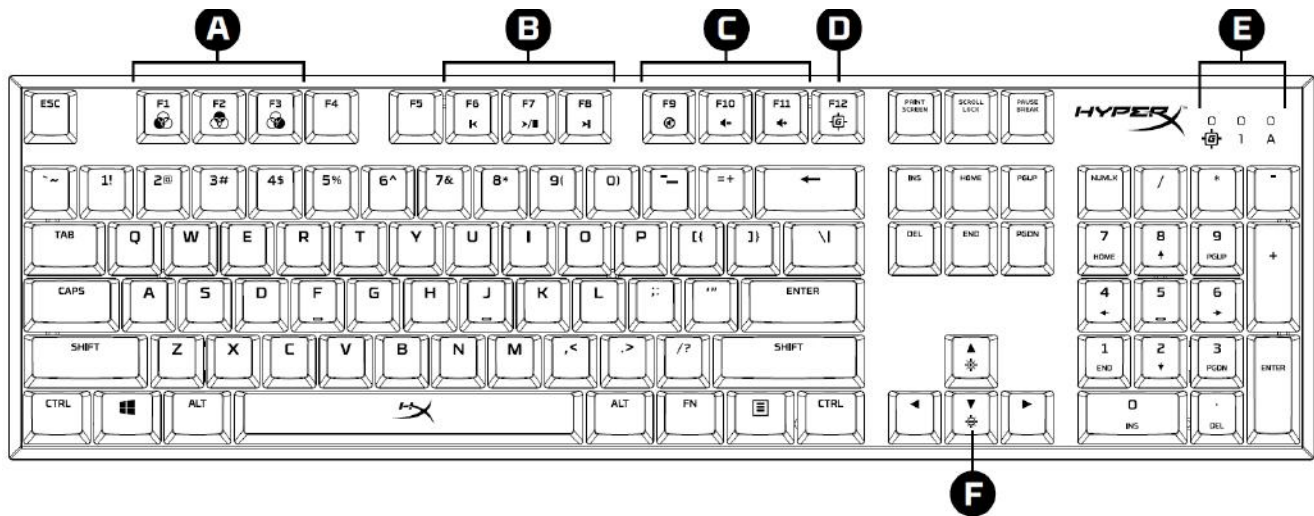









キーボードの概要:





A- FN + F1, F2, F3 = オンボードメモリプロファイル選択。  +   

B- FN + F6, F7, F8 = メディアコントロールキー。  +   

C- FN + F9, F10, F11 = ボリュームコントロールキー。  +   

D- FN + F12 ゲームモードキー。  + 

E- Game Mode / Num Lock / Caps Lock のインジケータ。   

F- Up と Down = LED 輝度コントロールキー。  +  

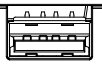
G- 背面の USB ポート = 携帯電話用 USB 充電ポート。  

H- 背面の mini USB ポート = キーボード USB ケーブルポート。 



キーボードの取り付け:

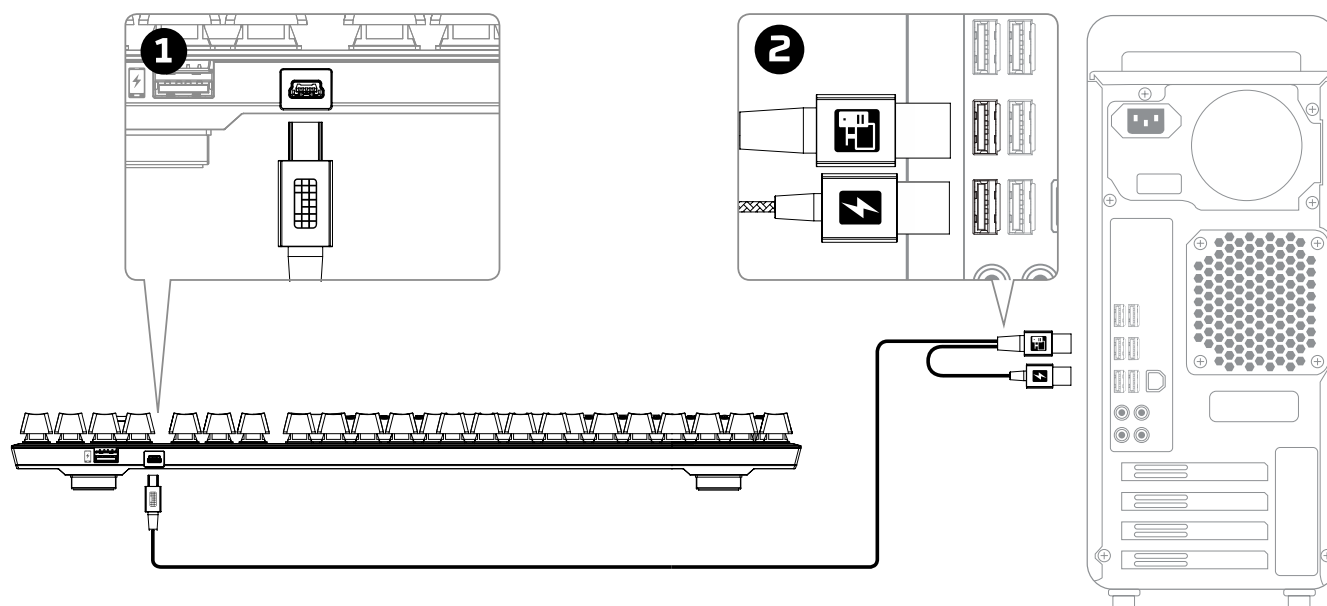

- 1- mini USB コネクタをキーボードに接続します。
- 2- 両方の USB コネクタをコンピューターに接続します。



ファンクションキー:



[FN] キーとファンクションキーを同時に押すと、セカンダリ機能が有効になります。

ファンクションキー	セカンダリ機能
	<p>オンボードメモリ上のプロファイルを切り替えます。</p>
	<p>メディアキーを使って、お手元の音楽/ビデオを再生/休止▶/⏸、巻き戻し、◀または巻き上げ▶▶できます。</p>
	<p>ボリュームコントロールキーを使って、コンピュータオーディオのミュート🔇、およびボリュームの調整◀- / +▶ができます。</p>
	<p>ゲームモード🎮を有効にすることで、Windows キーを無効にし、ゲーム中に不便な事態に陥ることを避けられます。ゲームモードを選択するとインジケータが点灯します。</p>
	<p>これらのキーを使って、LED バックライトの明るさを調整🔆🔆🔆🔆🔆します。5段階の明るさに調整できます：0%, 25%, 50%, 75%, 100%。</p>



HyperX NGenuity ソフトウェア :

照明、ゲームモード、マクロ設定をカスタマイズするには、HyperX NGenuity ソフトウェアを以下のサイトからダウンロードしてください。 hyperxgaming.com/ngenuity.

機能の詳細については、『HyperX NGenuity ゲーミングソフトウェア』マニュアルをご覧ください。

キーボードを工場出荷状態にリセットする:

キーボードに問題が生じた場合、工場出荷状態に戻すことができます。キーボードの工場出荷状態へのリセット: を行った場合、カスタム LED プロファイルは失われます。

キーボードに問題が生じた場合、工場出荷状態に戻すことができます。この場合、カスタム LED プロファイルは失われます。

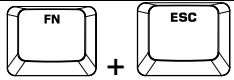
ファンクションキー	セカンダリ機能
	キーボードのバックライトが点滅するまで両方のキーを 5 秒以上押し続けます。



HyperX Alloy FPS RGB 기계식 게임용 키보드



부품 번호
HX-KB1SS2-US
HX-KB1SS2-UK
HX-KB1SS2-RU
HX-KB1SS2-NO
HX-KB1SS2-LA
HX-KB1SS2-FR
HX-KB1SS2-DE



구성품:

- HyperX Alloy FPS RGB 기계식 게임용 키보드
- 분리형 USB 케이블





키보드 개요:

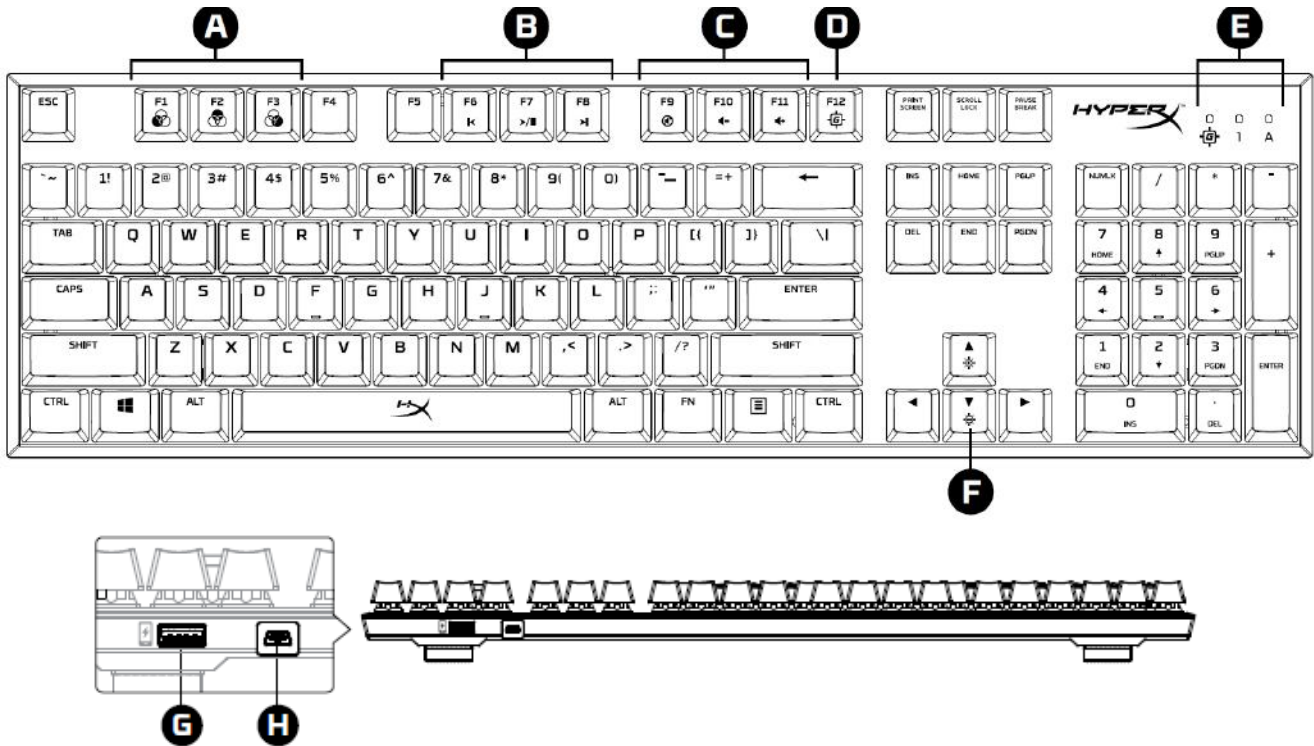

A- FN + F1, F2, F3 = 온보드 메모리 프로필 선택. +

B- FN + F6, F7, F8 = 미디어 제어 키. +

C- FN + F9, F10, F11 = 볼륨 제어 키. +

D- FN + F12 게임 모드 키. +

E- 게임 모드 / Num Lock / Caps Lock 표시기. 1 A

F- 위 및 아래 = LED 밝기 제어 키. +

G- 후면 USB 포트 = 휴대폰 USB 충전 포트.

H- 후면 미니 USB 포트 = 키보드 USB 케이블 포트.





키보드 설치:

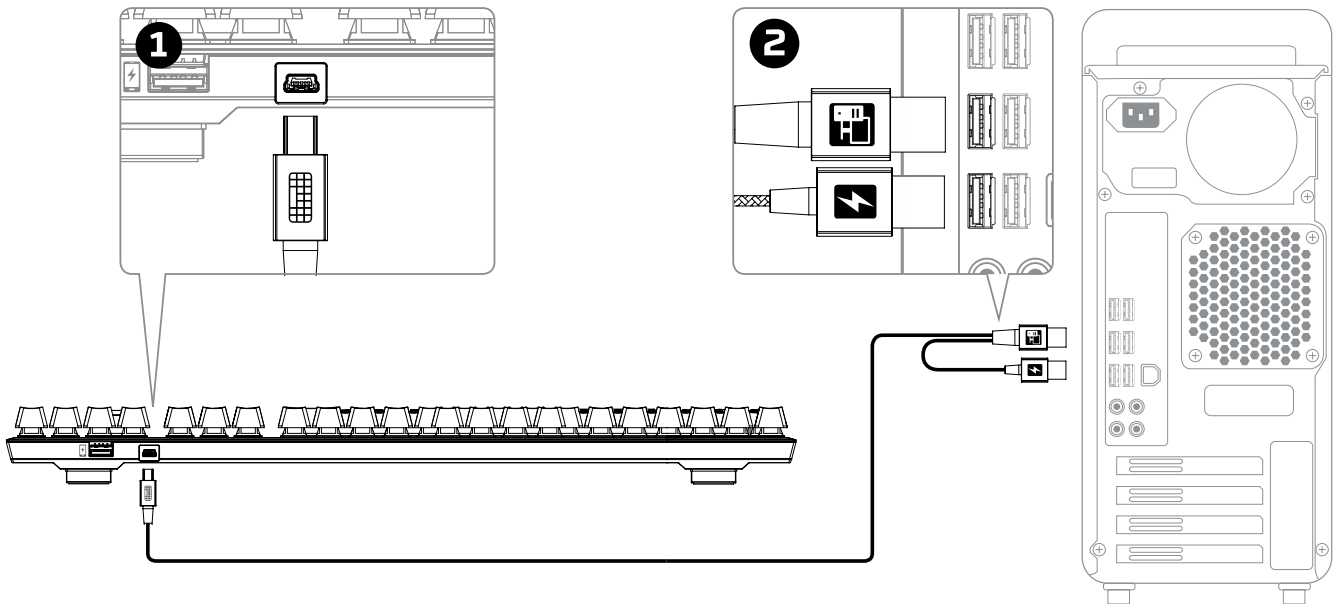

- 1- 미니 USB 커넥터를 키보드에 연결합니다.
- 2- 컴퓨터에 USB 커넥터들을 모두 연결합니다.



기능 키:



제 2 기능을 활성화하려면 동시에 "FN"과 기능 키를 누르십시오.

기능 키	제 2 기능
	<p>온보드 메모리의 프로필을 전환합니다.</p>
	<p>음악이나 비디오에서 미디어 키를 이용하여 재생/일시 정지 ▶/ , 뒤로 건너뛰기 ◀ 또는 앞으로 건너뛰기 ▶ 조작이 가능합니다.</p>
	<p>볼륨 제어 키를 이용하여 컴퓨터 오디오 음소거 🔇, 줄이기 ◀- 또는 키우기 ▶+ 등의 조정이 가능합니다.</p>
	<p>게임 모드 🎮 를 활성화해 Windows 키를 비활성화하고 게임 중 불편을 방지하십시오. 게임 모드가 활성화된 경우 표시기에 조명이 들어옵니다.</p>
	<p>이 키로 LED 백라이트 밝기를 높이거나 ☀️ 낮추십시오 🌑. 다음과 같은 5 개 단계의 밝기가 있습니다. 0%, 25%, 50%, 75%, 100%.</p>



HyperX NGenuity 소프트웨어:



조명, 게임 모드 및 매크로 설정을 사용자 지정하려면 여기에서 HyperX NGenuity 소프트웨어를 다운로드하십시오. hyperxgaming.com/ngenuity.

기능에 대한 자세한 정보는 HyperX NGenuity 게임용 소프트웨어 설명서를 참조하십시오.

키보드 공장 기본값 재설정:

키보드에 문제가 있는 경우 공장 기본값 재설정을 실행할 수 있습니다. 이 키보드 공장 기본값 재설정을 실행하면 사용자 지정 LED 프로필이 손실될 수 있습니다.

키보드에 문제가 있는 경우 공장 기본값 재설정을 실행할 수 있습니다. 이를 실행하면서 사용자 지정 LED 프로필이 손실될 수 있습니다.

기능 키	제 2 기능
 + 	키보드 백라이트가 깜박일 때까지 두 키를 5 초간 누르십시오.



คีย์บอร์ดเกมมิ่ง **HyperX Alloy FPS RGB**



หมายเลขชิ้นส่วน
HX-KB1SS2-US
HX-KB1SS2-UK
HX-KB1SS2-RU
HX-KB1SS2-NO
HX-KB1SS2-LA
HX-KB1SS2-FR
HX-KB1SS2-DE



สิ่งที่จัดมาให้:





- คีย์บอร์ดเกมมิ่ง HyperX Alloy FPS RGB
- สาย USB แบบถอดแยกได้



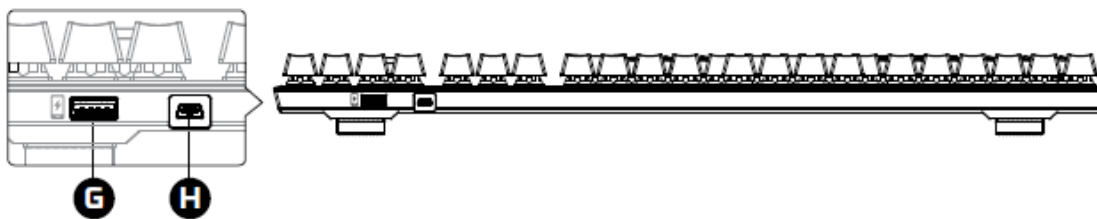
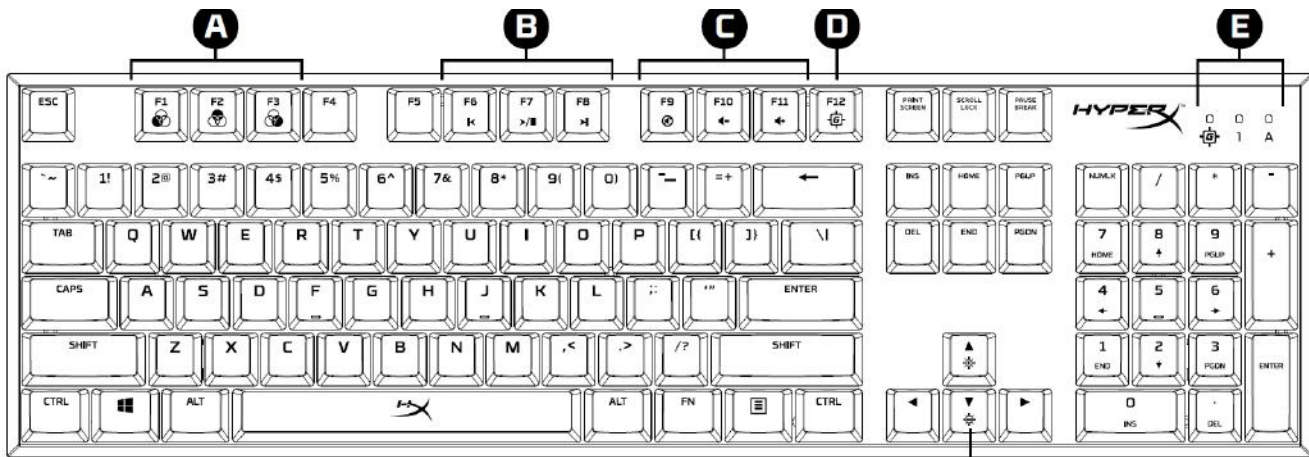









เบื้องต้นเกี่ยวกับแป้นพิมพ์:





A- FN + F1, F2, F3 = เลือกไฟส่องหน่วยความจำออนบอร์ด  +   



B- FN + F6, F7, F8 = ปุ่มควบคุมสื่อมีเดีย  +   

C- FN + F9, F10, F11 = ปุ่มปรับระดับเสียง  +   

D- FN + F12 ปุ่มโหมดเล่นเกม  + 

E- ไฟสถานะโหมดเกม / Num Lock / Caps Lock   

F- ขึ้นลง = ปุ่มปรับความสว่าง LED  +  

G- พอร์ต mini USB ด้านหลัง = พอร์ตสาย USB แป้นพิมพ์  



H- พอร์ต mini USB ด้านหลัง = พอร์ตสาย USB แฉิ่งพิมพ์ 



การติดตั้งแป้นพิมพ์:

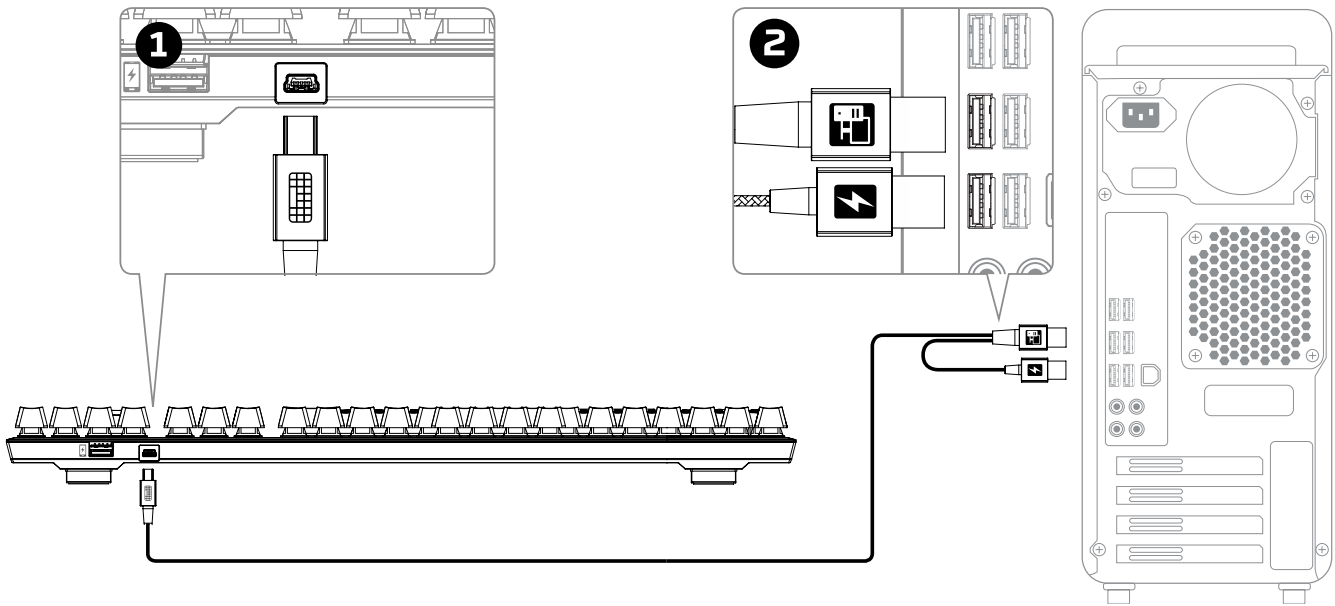

- 1- ต่อหัวต่อ Mini USB เข้ากับแป้นพิมพ์
- 2- ต่อหัวต่อ USB ทั้งสองเข้ากับคอมพิวเตอร์



ปุ่มฟังก์ชัน



กด "FN" และปุ่มฟังก์ชันพร้อม ๆ กันเพื่อเปิดใช้คุณสมบัติการทำงานรอง

ปุ่มฟังก์ชัน	คุณสมบัติเด่นเพิ่มเติม
	สลับระหว่างโพรไฟล์ใช้งานในหน่วยความจำออนบอร์ด
	สามารถใช้ปุ่มมีเดียเพื่อเปิดเล่น/หยุดชั่วคราว ▶/ กรอถอยหลัง ◀ หรือกรอเดินหน้า ▶ เพลงหรือวิดีโอที่เปิดอยู่
	คุณสามารถปิดเสียงได้ผ่านปุ่มปรับระดับเสียง 🔊 ลด ◀- หรือเพิ่ม ◀+ เสียงคอมพิวเตอร์ของคุณ
	การเปิดใช้ Game Mode 🎮 จะเป็นการปิดใช้งานปุ่ม Windows เพื่อป้องกันการแทรกระหว่างการเล่นเกมโดยไม่ได้ตั้งใจ ขณะเปิดใช้งานโหมดเล่นเกม ไฟสถานะจะติดสว่าง
	เพิ่ม ☀️ หรือลด ☁️ ความสว่างไฟพื้นหลัง LED ผ่านปุ่มเหล่านี้ ปรับความสว่างได้ 5 ระดับได้แก่ 0%, 25%, 50%, 75%, 100%.



ซอฟต์แวร์ **HyperX NGenuity:**

ปรับไฟส่องสว่าง โหมดเกมและคามาโครโดยดาวน์โหลดซอฟต์แวร์ HyperX NGenuity ที่นี่: hyperxgaming.com/ngenuity.

ดูข้อมูลฟังก์ชันการทำงานต่าง ๆ ได้จากซอฟต์แวร์ HyperX NGenuity Gaming

รีเซ็ตแป้นพิมพ์เป็นค่าจากโรงงาน:

หากคุณพบปัญหาเกี่ยวกับแป้นพิมพ์ คุณสามารถรีเซ็ตคีนค่าจากโรงงานได้ โพรไฟล์ LED กำหนดเองของคุณจะหายไปหลังขั้นตอนนี้รีเซ็ตแป้นพิมพ์เป็นค่าจากโรงงาน:

หากคุณพบปัญหาเกี่ยวกับแป้นพิมพ์ คุณสามารถรีเซ็ตคีนค่าจากโรงงานได้ โพรไฟล์ LED กำหนดเองของคุณจะหายไปหลังขั้นตอนนี้

ปุ่มฟังก์ชัน	คุณสมบัติเด่นเพิ่มเติม
 + 	กดปุ่มทั้งสองเป็นเวลา 5 วินาทีจนกว่าไฟพื้นหลังแป้นพิมพ์จะติดกะพริบ



Bàn phím chơi game cơ học HyperX Alloy FPS RGB



Mã sản phẩm

HX-KB1SS2-US

HX-KB1SS2-UK

HX-KB1SS2-RU

HX-KB1SS2-NO

HX-KB1SS2-LA

HX-KB1SS2-FR

HX-KB1SS2-DE

**Bộ sản phẩm gồm có:**





- Bàn phím chơi game cơ học HyperX Alloy FPS RGB
- Cáp USB rời



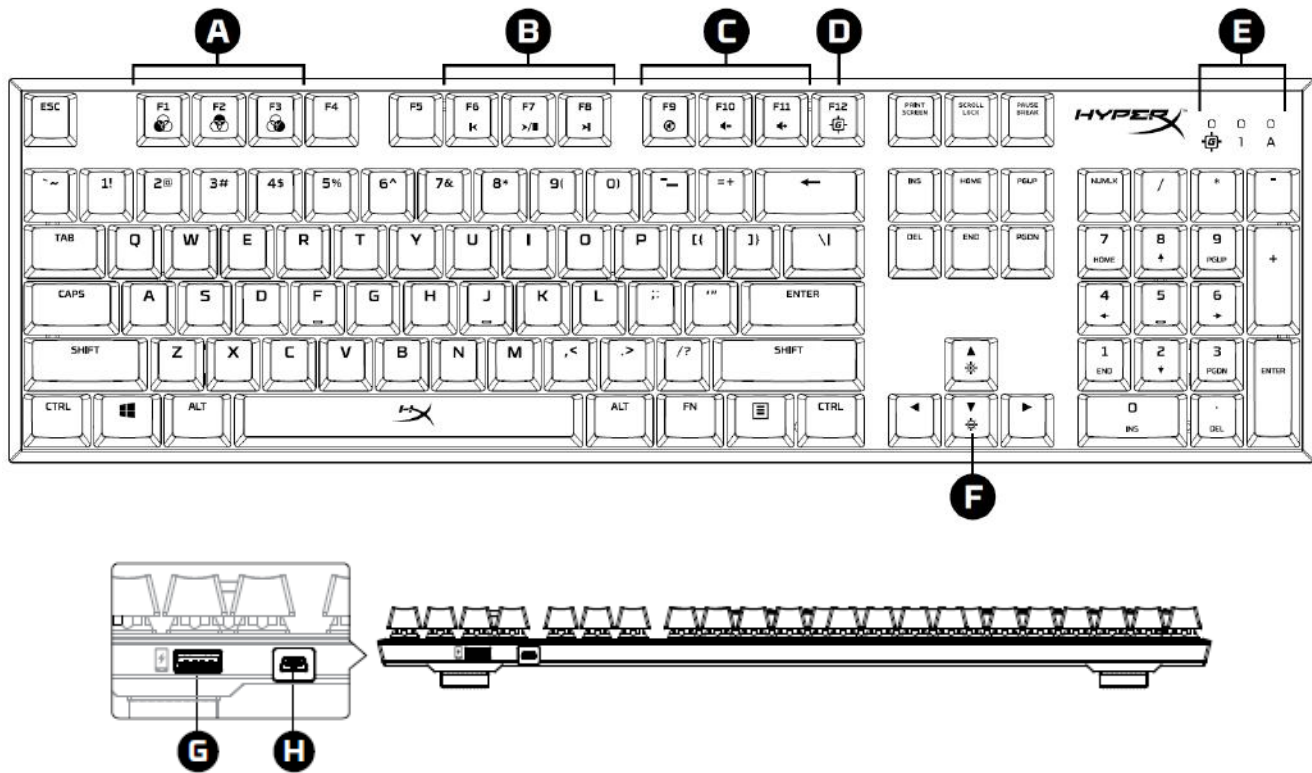







Giới thiệu chung về bàn phím:









A- FN + F1, F2, F3 = Chọn cấu hình trên bộ nhớ riêng.  +   



B- FN + F6, F7, F8 = Phím điều khiển phương tiện.  +   

C- FN + F9, F10, F11 = Phím điều chỉnh âm lượng.  +   

D- FN + F12 phím Chế độ game.  + 

E- Đèn báo Chế độ game / Khóa số / Khóa chữ hoa.   

F- Up & Down = Phím điều khiển độ sáng đèn LED.  +  

G- Cổng USB phía sau = Cổng sạc USB cho điện thoại di động.  



H- Cổng mini USB phía sau = Cổng cấp USB bàn phím. 



Cài đặt bàn phím:

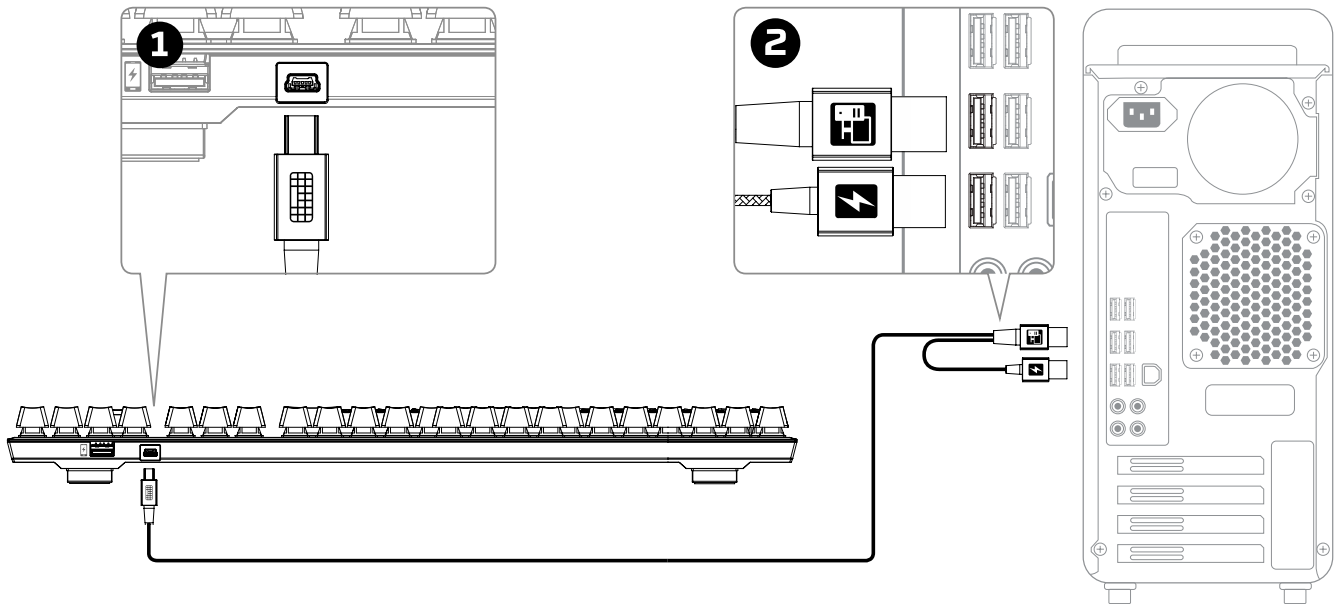

- 1- Cắm đầu Mini USB vào bàn phím.
- 2- Cắm cả hai đầu USB vào máy tính.



Các phím chức năng:



Nhấn “FN” và một phím chức năng cùng lúc để kích hoạt tính năng phụ của phím chức năng đó.

Các phím chức năng	Tính năng phụ
	<p>Chuyển đổi giữa các cấu hình trên bộ nhớ riêng.</p>
	<p>Với phím phương tiện bạn có thể mở/tạm dừng nội dung ▶/ , tua ngược ◀ hoặc tua tới ▶ bản nhạc hoặc tập video của bạn.</p>
	<p>Với phím điều chỉnh âm lượng, bạn có thể tắt tiếng 🔇, giảm ◀- hoặc tăng ◀+ âm thanh trên máy tính.</p>
	<p>Bật Chế độ game 🎮 sẽ vô hiệu phím Windows để tránh bị chạm phải khi chơi game. Khi Chế độ game được bật, đèn báo của nó sẽ sáng.</p>
	<p>Tăng ☀️ hoặc giảm ☹️ độ sáng của đèn nền LED bằng những phím này. Có 5 cấp độ sáng: 0%, 25%, 50%, 75%, 100%.</p>



Phần mềm HyperX NGenuity:



Để điều chỉnh các thiết lập ánh sáng, Chế độ game và macro theo ý muốn, tải xuống phần mềm HyperX NGenuity tại đây: hyperxgaming.com/ngenuity.

Tham khảo hướng dẫn sử dụng phần mềm game HyperX NGenuity để biết thêm về các chức năng.

Đặt bàn phím về thiết lập ban đầu:

Nếu gặp bất kỳ sự cố nào với bàn phím, bạn có thể đặt về thiết lập ban đầu. Bạn sẽ mất cấu hình LED tùy chỉnh khi thực hiện **đặt bàn phím về thiết lập ban đầu**:

Nếu gặp bất kỳ sự cố nào với bàn phím, bạn có thể đặt về thiết lập ban đầu. Bạn sẽ mất cấu hình LED tùy chỉnh khi làm vậy.

Các phím chức năng	Tính năng phụ
 + 	Nhấn cả hai phím trong 5 giây cho tới khi đèn nền của bàn phím nhấp nháy.



HyperX Alloy FPS RGB 机械游戏键盘



产品型号
HX-KB1SS2-US
HX-KB1SS2-UK
HX-KB1SS2-RU
HX-KB1SS2-NO
HX-KB1SS2-LA
HX-KB1SS2-FR
HX-KB1SS2-DE



包含内容：

- HyperX Alloy FPS RGB 机械游戏键盘
- 可拆卸 USB 线缆





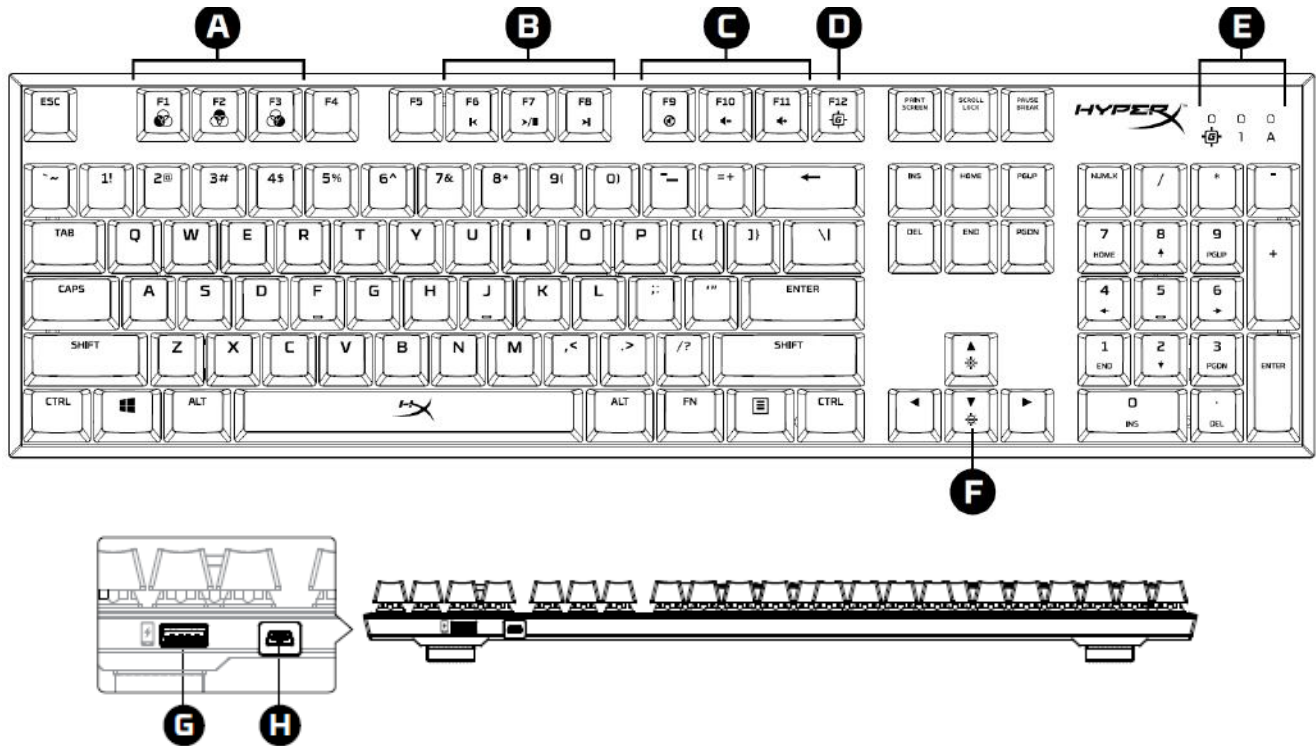

键盘概览：

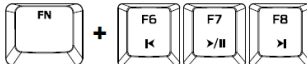

A- FN + F1、F2、F3 = 板载内存配置文件选择。 

B- FN + F6、F7、F8 = 媒体控制键。 

C- FN + F9、F10、F11 = 音量控制键。 

D- FN + F12 游戏模式键。 

E- 游戏模式/数字锁定/大写锁定标识。 

F- 向上和向下 = LED 亮度控制键。 

G- 背部 USB 端口 = 手机 USB 充电端口。 

H- 背后迷你 USB 端口 = 键盘 USB 线缆端口。 



键盘安装：

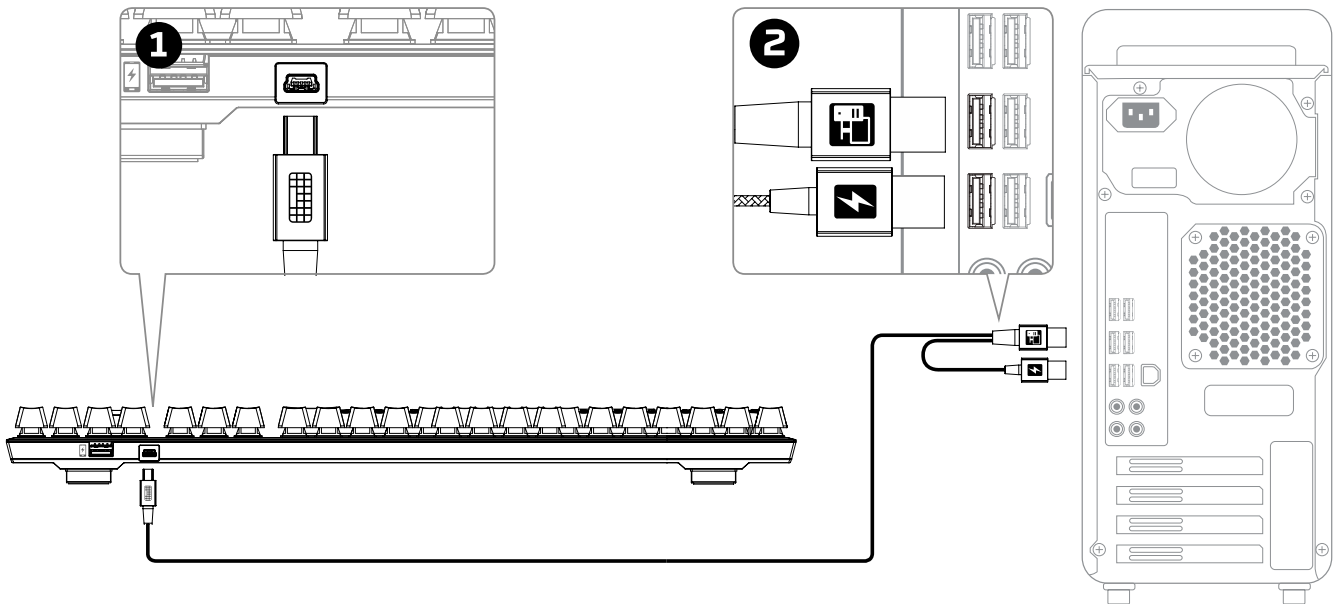

- 1- 将迷你 USB 接头连接到键盘。
- 2- 将两个 USB 端口连接到电脑。



功能键：



同时按下“FN”和功能键，可激活其次要功能。

功能键	次要功能
	<p>在板载内存上的配置文件之间切换。</p>
	<p>可利用媒体键播放/暂停 ▶/ ，向后跳过 ◀ 或向前跳过 ▶ 音乐或视频。</p>
	<p>可利用音量控制键静音 🔇，调低 ◀- 或调高 ▶+ 电脑音频。</p>
	<p>启动游戏模式 🎮 可禁用 Windows 键并防止在游戏中发生任何不便。启用游戏模式之后，指示灯将亮起。</p>
	<p>利用这些按键调高或 ☀️ 调低 🌑 LED 背光亮度。共有 5 个亮度级别：0%，25%，50%，75%，100%。</p>



HyperX NGenuity 软件：

要定制灯光、游戏模式和宏设置，请在此处下载 HyperX NGenuity 软件：hyperxgaming.com/ngenuity

。

参阅 HyperX NGenuity 游戏软件手册了解更多有关功能的信息。

键盘恢复出厂设置：

如果遇到任何键盘问题，可以执行恢复出厂设置。恢复**键盘出厂设置**将失去自定义 LED 配置文件：

如果遇到任何键盘问题，可以执行恢复出厂设置。这样会失去自定义的 LED 配置文件。

功能键	ESC 键
	按下两个键保持 5 秒钟，直到键盘背光开始闪烁。



HyperX Alloy FPS RGB 機械式電競鍵盤

盤



產品型號

HX-KB1SS2-US

HX-KB1SS2-UK

HX-KB1SS2-RU

HX-KB1SS2-NO

HX-KB1SS2-LA

HX-KB1SS2-FR

HX-KB1SS2-DE



內容物：

- HyperX Alloy FPS RGB 機械式電競鍵盤
- 可拆式 USB 電源線





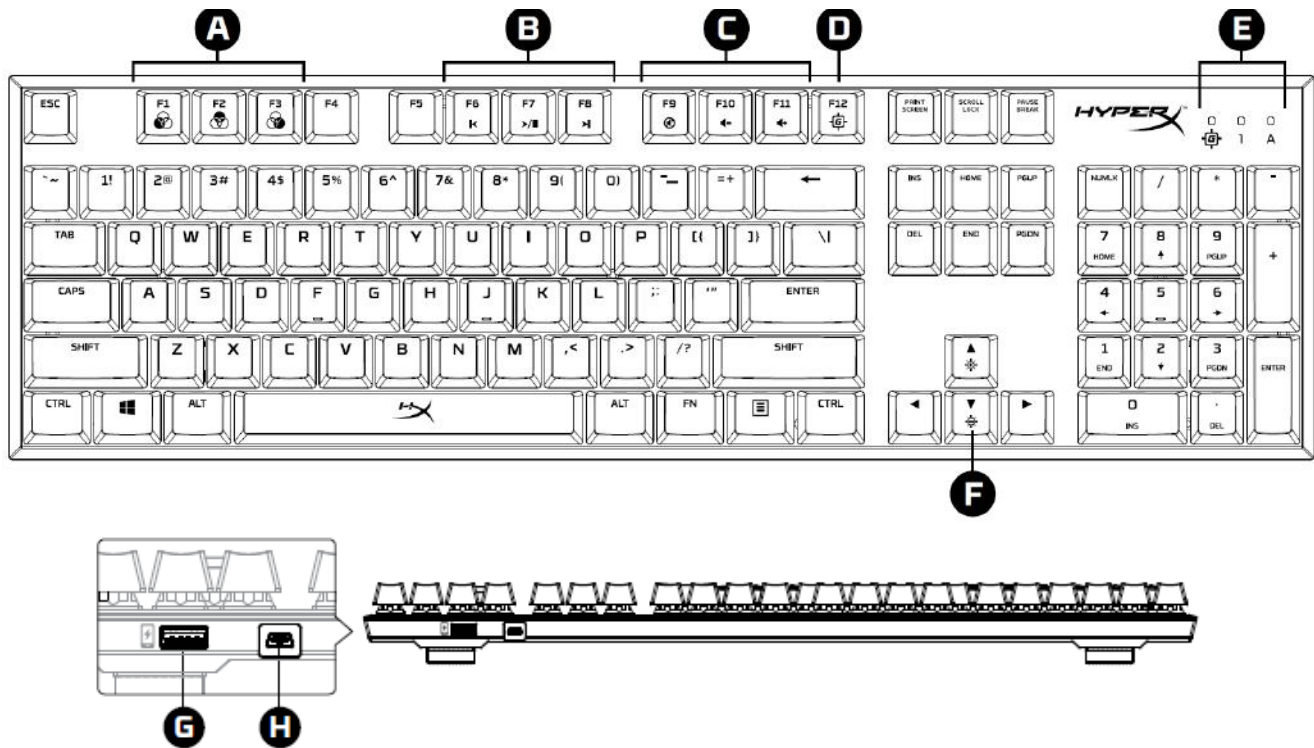

鍵盤概觀：

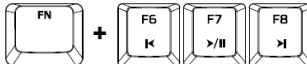

A- FN + F1, F2, F3 = 個人設定檔選擇。 

B- FN + F6, F7, F8 = 媒體控制鍵。 

C- FN + F9, F10, F11 = 音量控制鍵。 

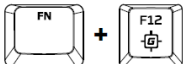
D- FN + F12 遊戲模式鍵。 

E- 遊戲模式 / 數字鎖定 / 大小寫鎖定顯示燈。 

F- 向上鍵和向下鍵 = LED 亮度控制按鈕。 

G- 後方 USB 連接埠 = 手機 USB 充電連接埠。 

H- 後方 mini USB 連接埠 = 鍵盤 USB 線連接埠。 



鍵盤安裝：

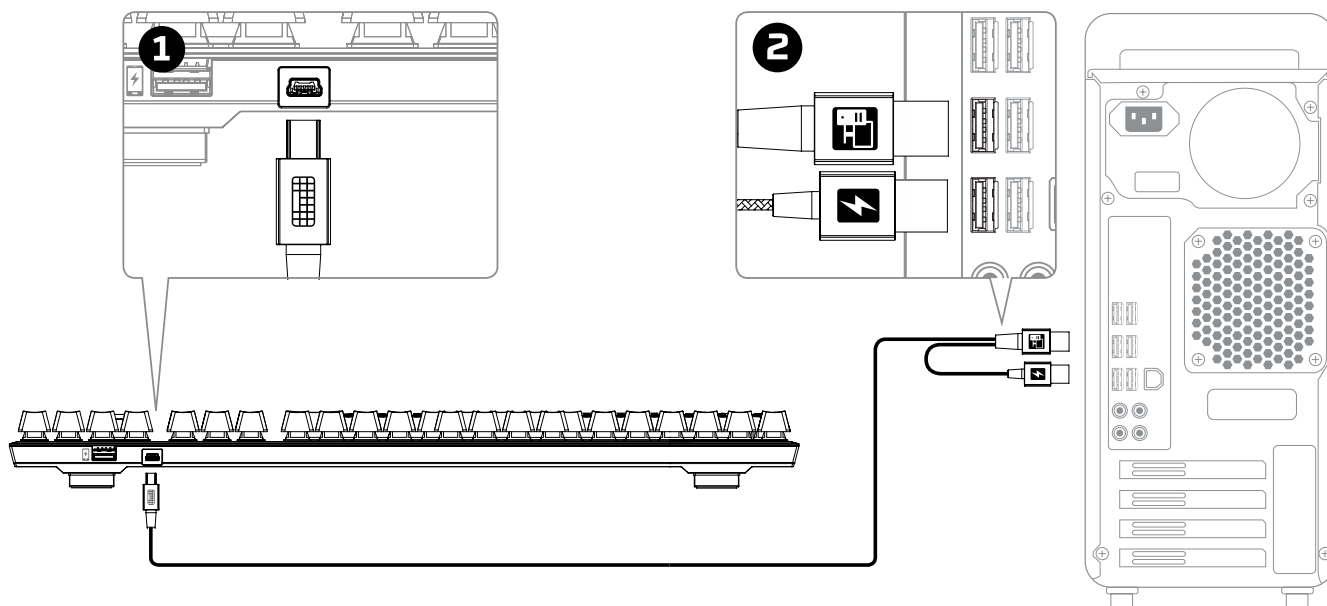

- 1- 將 Mini USB 接頭連接至鍵盤。
- 2- 將兩組 USB 接頭都連接至電腦。



功能鍵：



同時按下“FN”和個別功能鍵以啟動其對應功能。

功能鍵	對應功能
	<p>在內建記憶體設定檔之間切換。</p>
	<p>您可以使用媒體鍵來播放/暫停 ▶/ 、 倒轉◀或快轉▶音樂或影片。</p>
	<p>您可以使用音量控制鍵來靜音 🔇、 降低◀-或調高+▶電腦音量。</p>
	<p>啟用遊戲模式 🎮 來停用 Windows 鍵，以避免遊戲中發生 不便。當遊戲模式 啟用時，指示燈亮起。</p>
	<p>您可以使用這些按鍵調高☀️或降 低☀️ LED 背光亮度。本產品有 5 個亮度等級：0%、25%、 50%、75%、100%。</p>



HyperX NGenuity 軟體：

若要自訂燈光效果、遊戲模式和巨集設定，請於以下連結下載 HyperX NGenuity 軟體：
hyperxgaming.com/ngenuity。

參考 HyperX NGenuity 電競軟體使用說明，以獲得更多功能相關資訊。

還原原廠設定：

如果你的鍵盤有任何問題，你可以將鍵盤還原為原廠設定。還原**鍵盤至原廠設定**，將導致您的自訂**LED 設定檔**被清除：

如果你的鍵盤有任何問題，你可以將鍵盤還原為原廠設定。此舉會讓自訂的**LED 設定**消失。

功能鍵	對應功能
	同時按下兩個按鍵 5 秒鐘 ，直到鍵盤背光閃爍。