



**MODEL N° 90023**

.....

***OWNER'S MANUAL***

**COPY**

**Keep this Product ID Number and use when contacting Customer Service:**

## **REGISTER YOUR LIFETIME PRODUCT TODAY!**

### **REGISTER YOUR PRODUCT ONLINE AT [WWW.LIFETIME.COM](http://WWW.LIFETIME.COM)**

At Lifetime, we are committed to providing innovative and quality products. While registering, you will have the opportunity to give us your feedback. Your input is valuable to us.

- You can also opt in to receive new product notifications or promotions.
- In the unlikely event of a product recall or safety modification, your registration provides the information we need to notify you directly.
- Registration is fast, easy, and completely voluntary.

#### **LIFETIME'S PROMISE TO YOU:**

*Maintaining your privacy is our long-standing policy at Lifetime. And you can rest assured that Lifetime will not sell or provide your personal data to other third parties, or allow them to use your personal data for their own purposes.*

We invite you to read our privacy policy at [www.lifetime.com](http://www.lifetime.com)

**REGISTER today!**

**Save this owner's manual for future reference and in the event that the manufacturer has to be contacted.**

**\*\*U.S. and Canada customers ONLY\*\***

IF ASSISTANCE IS NEEDED,

**DO NOT CONTACT THE STORE!**

**CALL OUR CUSTOMER SERVICE DEPARTMENT at**

**1 (800) 225-3865**

HOURS: 7:00 a.m. to 5:00 p.m. Monday through Friday (Mountain Standard Time)

\*\*Call us or visit our Web site for Saturday hours\*\*

**Lifetime Products, Inc.**

**PO Box 160010 • Freeport Center, Bldg. D-11 Clearfield, Utah 84016-0010**

\*\*For customers outside the U.S. or Canada, please contact the store for assistance.\*\*



## **SAFETY INSTRUCTIONS**



### **FAILURE TO FOLLOW THESE WARNINGS MAY RESULT IN SERIOUS INJURY OR PROPERTY DAMAGE AND WILL VOID WARRANTY.**

To ensure safety, do not attempt to assemble this product without reading and following all instructions carefully. Check the entire box and inside all packing materials for parts and/or additional instruction material. Before beginning assembly, identify and inventory all parts and hardware using the parts and hardware lists and identifiers in this document. Proper and complete assembly, use and supervision are essential for proper orientation and to reduce the risk of accident or injury. A high probability of serious injury exists if this product is not installed, maintained, and/or operated properly. Failure to comply with any of the warnings in this instruction manual may result in serious personal injuries such as cuts, broken bones, nerve damage, paralysis, brain injury, or death. Failure to comply may also result in property damage. Please heed all warnings and cautions.

- If using a ladder during assembly, use extreme caution.
- Two capable adults are recommended for this operation.
- Check base daily for leakage. Leaks may cause product to fall.
- Assemble the pole sections properly. Failure to do so could cause the pole sections to separate during play or transport.

*Most injuries are caused by misuse and/or not following instructions. Use caution when using this product.*

## **BEFORE BEGINNING ASSEMBLY**



Keep the hardware bags and their contents separate. If any parts are missing, call our Customer Service Department.



Identify and inventory all parts and hardware using the parts and hardware lists and identifiers in this document.



Test fit all Bolts by inserting them into their respective holes. If necessary, carefully scrape away any excess powder coating buildup from inside the holes. Do not scrape away all of the powder coating. Bare metal may rust. You may need to pound some Bolts into place with a hammer or mallet.



## TOOLS AND PARTS REQUIRED FOR THIS ASSEMBLY

1/2" Wrench

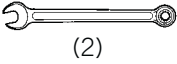

7/16" Wrench

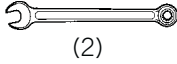

9/16" Wrench

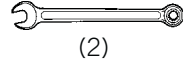

3/4" Wrench

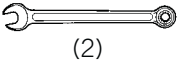

Phillips Screwdriver

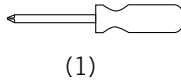

Pliers

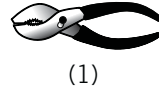

Rubber Mallet

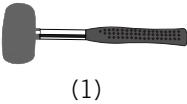

Scrap Wood

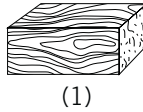

Sand



Funnel



Water Hose

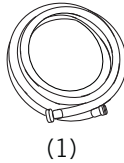

CCL-3/16" Allen Wrench

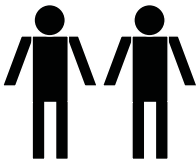
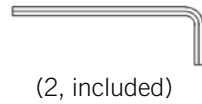

***\*Two adults required to complete assembly\****

**Only adults should set up the product. Do not allow children in the setup area until assembly is complete.**

# ASSEMBLY GUIDES

*Refer to the following areas throughout the instructions to assist in the assembly process:*

This area is located at the top, left-hand corner of the page and indicates which tools and hardware are needed to complete the assembly steps on a page.



**TOOLS AND HARDWARE REQUIRED FOR THIS PAGE**

This area is usually located in the bottom, left-hand corner of a step and indicates that special attention is needed to perform a particular part of a step.



*Note:*

These areas are usually located in the bottom, right-hand corner of a step and indicate that damage to the product or serious injury may occur if the caution or warning is not heeded.



**CAUTION**



**WARNING**

## PARTS LIST

<u>ID</u>	<u>Item Description</u>	<u>Qty</u>	<u>✓</u>
ALH	Top Pole	1	<input type="checkbox"/>
ALF	Middle Pole	1	<input type="checkbox"/>
ALE	Bottom Pole	1	<input type="checkbox"/>
AJK	Right Backboard Bracket	1	<input type="checkbox"/>
AJJ	Left Backboard Bracket	1	<input type="checkbox"/>
AJI	Backboard	1	<input type="checkbox"/>
ALX	Rim	1	<input type="checkbox"/>
AKZ	Net	1	<input type="checkbox"/>
AKC	Extension Arm	4	<input type="checkbox"/>
BDL	Dunk Latch	1	<input type="checkbox"/>
BDM	Inner Guard	1	<input type="checkbox"/>
BDN	Outer Guard	1	<input type="checkbox"/>
AJM	Base	1	<input type="checkbox"/>
ALI	Pole Brace	2	<input type="checkbox"/>
AMU	Wheel	2	<input type="checkbox"/>
AJC	1/2" x 15 3/4" Axle	1	<input type="checkbox"/>
AJE	1/2" x 7" Axle	1	<input type="checkbox"/>
AEF	Base Plug	2	<input type="checkbox"/>
AMT	Warning Sticker (Applied to Middle Pole)	1	<input type="checkbox"/>

## HARDWARE LIST

<u>ID</u>	<u>Item Description</u>	<u>Qty</u>	<u>✓</u>
<b>BCO</b>	<b>Pole Assembly Hardware</b>		
ADS	1/4" x 3/4" Screw	2	<input type="checkbox"/>
AOF	3/8" Plug	2	<input type="checkbox"/>
ANS	1/2" Nylon Plug	2	<input type="checkbox"/>
CIH	Domed Countersink Washer	2	<input type="checkbox"/>
<b>BCQ</b>	<b>Pole to Base Assembly Hardware</b>		
AAO	5/16" Nylock Nut	2	<input type="checkbox"/>
ABD	5/16" Washer	4	<input type="checkbox"/>
AAE	5/16" x 1" Hex Bolt	2	<input type="checkbox"/>
ABN	1/2" x 1/8" Spacer	2	<input type="checkbox"/>
BTS	1/4" Barrel Nut	1	<input type="checkbox"/>
BZO	1/4" x 3" Shoulder Bolt	1	<input type="checkbox"/>
CCL	3/16" Allen Wrench (not shown)	2	<input type="checkbox"/>
<b>BCS</b>	<b>Backboard to Rim Assembly Hardware</b>		
AAS	1/4" x 2 3/4" Hex Bolt	2	<input type="checkbox"/>
ABS	1/2" x 2 5/16" Galvanized Spacer	2	<input type="checkbox"/>
AAC	5/16" x 1 3/4" Hex Bolt	2	<input type="checkbox"/>
ADQ	5/16" x 1" Screw	2	<input type="checkbox"/>
AAB	1/4" Centerlock Nut	2	<input type="checkbox"/>
ABD	5/16" Washer	4	<input type="checkbox"/>

# HARDWARE LIST

ID	Item Description	Qty	✓
<b>BCS</b>	<b>Backboard to Rim Assembly Hardware, Continued</b>		
APK	3 1/2" U-Bolt	1	<input type="checkbox"/>
ABK	5/16" Nylock Flange Nut	4	<input type="checkbox"/>
AOX	Rim Support Channel	1	<input type="checkbox"/>
<b>BCR</b>	<b>Backboard to Pole Assembly Hardware</b>		
ADG	1/2" x 6.625" Hex Bolt	4	<input type="checkbox"/>
AAX	1/2" Centerlock Nut	4	<input type="checkbox"/>
ABL	.69" x .59" Black Spacer	4	<input type="checkbox"/>
ABP	1/2" x 3/8" Clear Poly Spacer	4	<input type="checkbox"/>
ABA	3/8" x 6 1/2" Hex Bolt	1	<input type="checkbox"/>
ABB	3/8" Centerlock Nut	1	<input type="checkbox"/>

# PARTS LIST

Parts shown at 10% of Actual Size

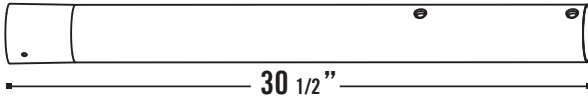

**ALH (x1)**  
Top Pole



**ALF (x1)**  
Middle Pole

\*Warning Sticker applied to side not shown

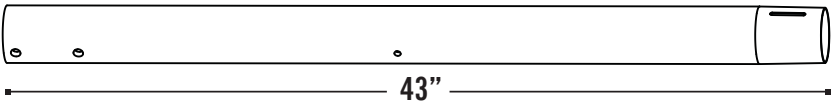

**ALE (x1)**  
Bottom Pole

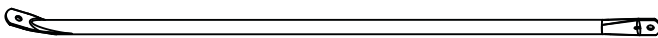

**ALI (x2)**  
Pole Brace

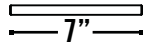

**AJE (x1)**  
1/2" x 7" Axle

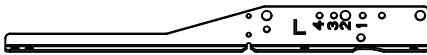

**AJJ (x1)**  
Left Backboard Bracket

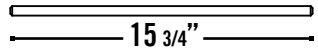

**AJC (x1)**  
1/2" x 15 3/4" Axle



**AJK (x1)**  
Right Backboard Bracket

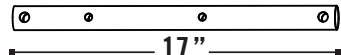

**AKC (x4)**  
Extension Arm

# PARTS IDENTIFIER

## Parts shown at 10% of Actual Size

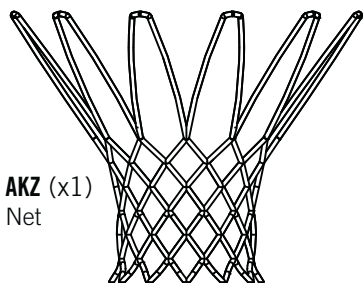

**AKZ (x1)**  
Net

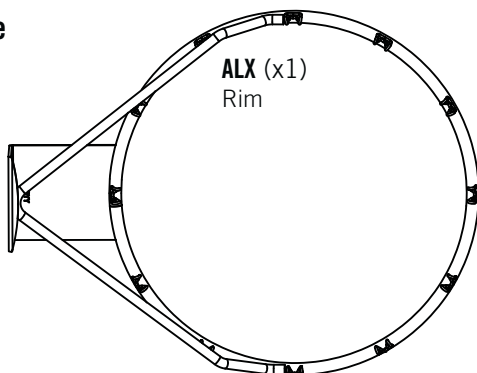

**ALX (x1)**  
Rim

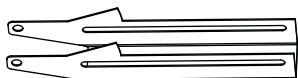

**BDN (x1)**  
Outer Guard



**BDL (x1)**  
Dunk Latch

## Parts shown at 5% of Actual Size

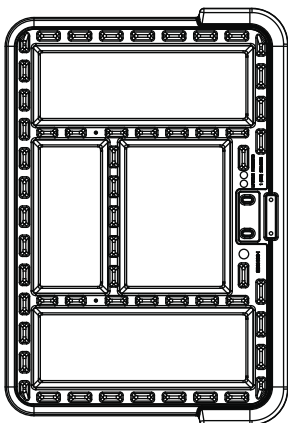

**AJI (x1)**  
Backboard

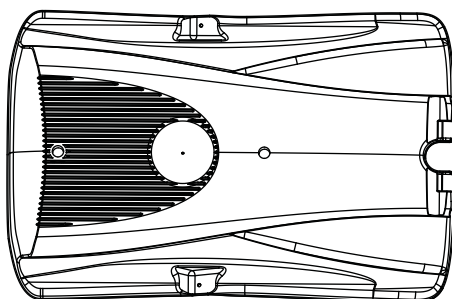

**AJM (x1)**  
Base

## Parts shown at 25% of Actual Size

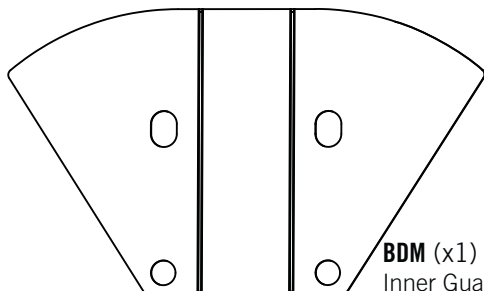

**BDM (x1)**  
Inner Guard

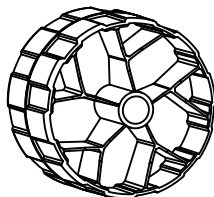

**AMU (x2)**  
Wheel



**AEF (x2)**  
Base Plug

# HARDWARE IDENTIFIER

## POLE ASSEMBLY HARDWARE

Hardware shown at Actual Size

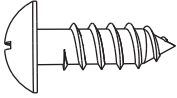

**ADS (x2)**  
1/4" x 3/4" Screw

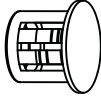

**AOF (x2)**  
3/8" Plug

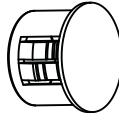

**ANS (x2)**  
1/2" Nylon Plug



**CIH (x2)**  
Domed Countersink Washer

## POLE TO BASE ASSEMBLY HARDWARE

Hardware shown at Actual Size

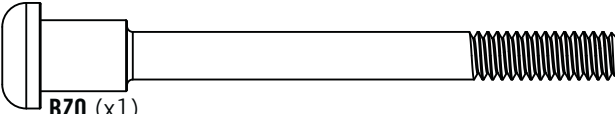

**BZO (x1)**  
1/4" x 3" Shoulder Bolt

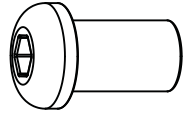

**BTS (x1)**  
1/4" Barrel Nut

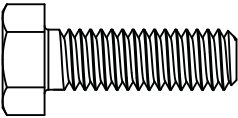

**AAE (x2)**  
5/16" x 1" Hex Bolt

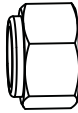

**AAO (x2)**  
5/16" Nylock Nut

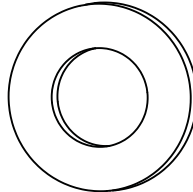

**ABN (x2)**  
1/2" x 1/8" Spacer

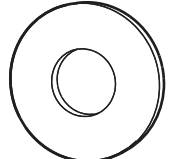

**ABD (x4)**  
5/16" Washer

## BACKBOARD TO RIM ASSEMBLY HARDWARE

Hardware shown at Actual Size

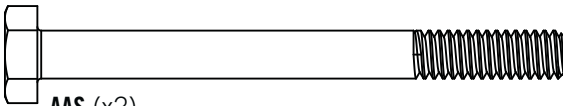

**AAS (x2)**  
1/4" x 2 3/4" Hex Bolt

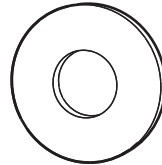

**ABD (x4)**  
5/16" Washer

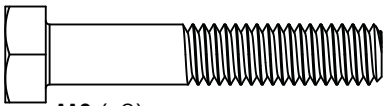

**AAC (x2)**  
5/16" x 1 3/4" Hex Bolt

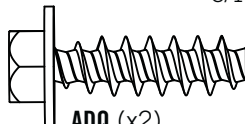

**ADQ (x2)**  
5/16" x 1" Screw



**ABK (x4)**  
5/16" Nylock Flange Nut

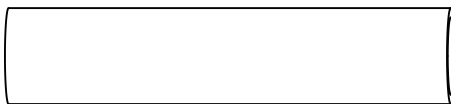

**ABS (x2)**  
1/2" x 2 5/16" Galvanized Spacer

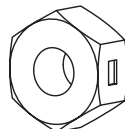

**AAB (x2)**  
1/4" Centerlock Nut

# HARDWARE IDENTIFIER

## BACKBOARD TO RIM ASSEMBLY HARDWARE (CONTINUED)

Hardware shown at 25% of Actual Size



**ADX (x1)**  
Rim Support Channel



**APK (x1)**  
3 1/2" U-Bolt

## BACKBOARD TO POLE ASSEMBLY HARDWARE

Hardware shown at Actual Size

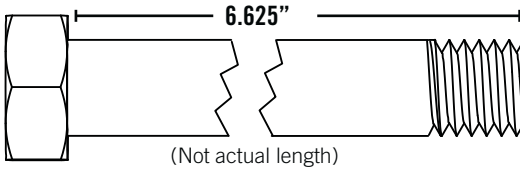

**ADG (x4)**  
1/2" x 6.625" Hex Bolt

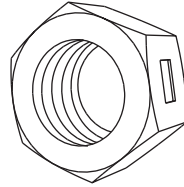

**AAX (x4)**  
1/2" Centerlock Nut

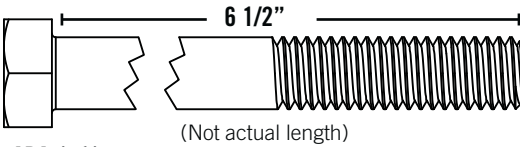

**ABA (x1)**  
3/8" x 6 1/2" Hex Bolt

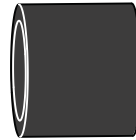

**ABL (x4)**  
.69" x .59" Black Spacer



**ABP (x4)**  
1/2" x 3/8" Clear Poly Spacer

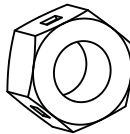

**ABB (x1)**  
3/8" Centerlock Nut

# SEC 1 POLE ASSEMBLY

## HARDWARE REQUIRED

Hardware shown at Actual Size

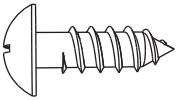

**ADS (x2)**  
1/4" x 3/4" Screw

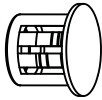

**AOF (x2)**  
3/8" Plug



**ANS (x2)**  
1/2" Nylon Plug

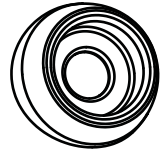

**CIH (x2)**  
Domed Countersink  
Washer

## PARTS REQUIRED

Parts shown at 10% of Actual Size

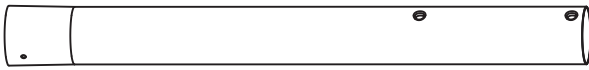

30 1/2"

**ALH (x1)**  
Top Pole

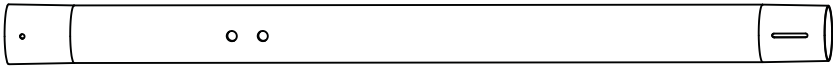

43"

**ALF (x1)**  
Middle Pole

\*Warning Sticker applied to side not shown

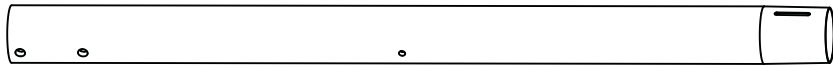

43"

**ALE (x1)**  
Bottom Pole

## TOOLS REQUIRED

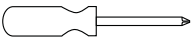

Phillips Screwdriver



Scrap Wood



## TOOLS AND HARDWARE REQUIRED FOR THIS PAGE

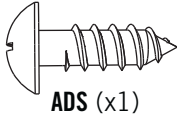
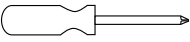

### SEC

#### 1.1

Align the hole in the **Top Pole (ALH)** with the slot in the **Middle Pole (ALF)** and slide the Top Pole over the Middle Pole. Insert a **1/4" x 3/4" Screw (ADS)** through the small hole in the Top Pole and into the slot in the Middle Pole as shown.

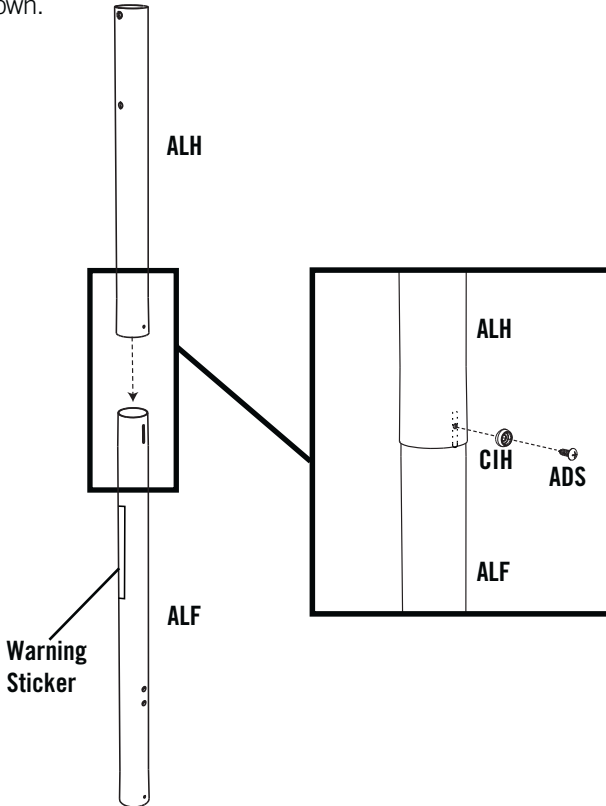

*Note: The 1/4" x 3/4" Screw should be flush with the Pole, but will spin freely once installed. Do not jam the Poles together until instructed.*



## TOOLS AND HARDWARE REQUIRED FOR THIS PAGE

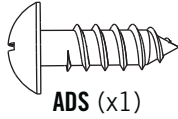
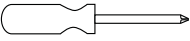

### SEC

#### 1.2

Align the hole in the **Middle Pole (ALF)** with the slot in the **Bottom Pole (ALE)** and slide the Middle Pole over the Bottom Pole. Insert a **1/4" x 3/4" Screw (ADS)** through the small hole in the Middle Pole and into the slot in the Bottom Pole as shown.

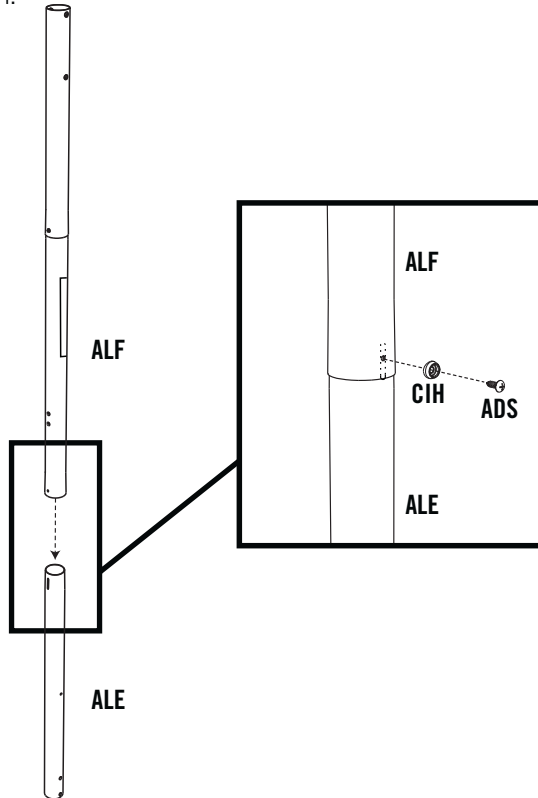

*Note: The 1/4" x 3/4" Screw should be flush with the Pole, but will spin freely once installed. Do not jam the Poles together until instructed.*



## TOOLS AND HARDWARE REQUIRED FOR THIS PAGE

### NO TOOLS REQUIRED FOR THIS PAGE

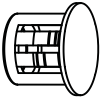

AOF (x2)

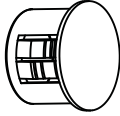

ANS (x2)

SEC

1.3

Insert the **3/8" Plugs (AOF)** into the small holes on the **Middle Pole (ALF)**. Then insert the **1/2" Nylon Plugs (ANS)** into the large holes on the other side of the Middle Pole as shown.

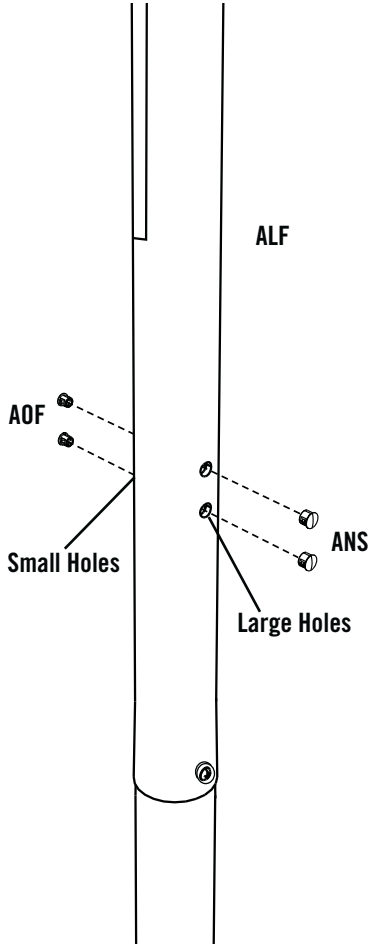



## TOOLS AND HARDWARE REQUIRED FOR THIS PAGE



### NO HARDWARE REQUIRED FOR THIS PAGE

SEC

1.4

#### ATTENTION: THIS STEP CANNOT BE REVERSED!

In order to seat the Poles, strike each end of the Pole very hard five to six times on a piece of scrap wood or cardboard. This must be done even if the Poles cover the slots before seating has occurred.

If the **Top and Middle Poles (ALH & ALF)** do not completely cover the slots on the **Middle and Bottom Poles (ALF & ALE)** after seating, **DO NOT COMPLETE ASSEMBLY**. Call our Customer Service Department.

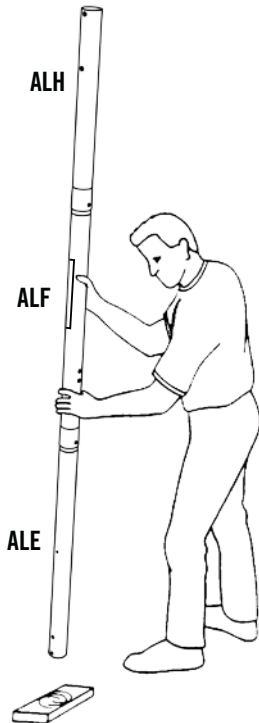

### WARNING

The Poles must be seated together! Even if the Poles cover the slots before seating, they must be struck on a hard surface five to six times! Failure to seat the Poles correctly could allow the Poles to separate during use, which could lead to serious personal injuries or property damage.



*Note: Do not hit your feet with the Pole sections, as serious injury could occur.*

## SEC 2 POLE TO BASE ASSEMBLY

### HARDWARE REQUIRED

Bag BCQ

Hardware shown at Actual Size

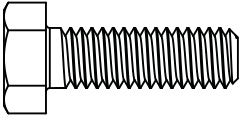

**AAE** (x2)  
5/16" x 1" Hex Bolt

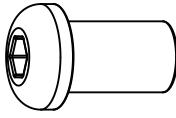

**BTS** (x1)  
1/4" Barrel Nut

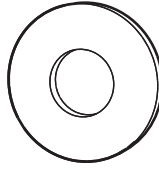

**ABD** (x4)  
5/16" Washer

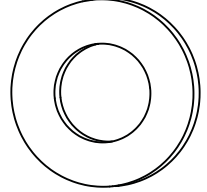

**ABN** (x2)  
1/2" x 1/8" Spacer

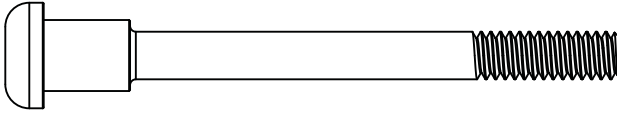

**BZO** (x1)  
1/4" x 3" Shoulder Bolt

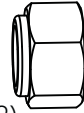

**AAO** (x2)  
5/16" Nylock Nut

### PARTS REQUIRED

Part shown at 5% of Actual Size

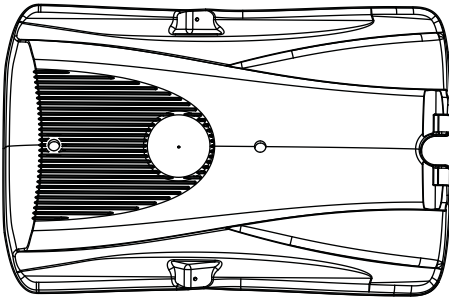

**AJM** (x1)  
Base

Part shown at 25% of Actual Size

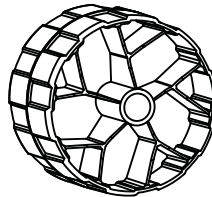

**AMU** (x2)  
Wheel

Parts shown at 10% of Actual Size

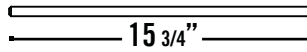

**AJC** (x1)  
1/2" x 15 3/4" Axle

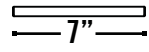

**AJE** (x1)  
1/2" x 7" Axle

**ALI** (x2)  
Pole Brace

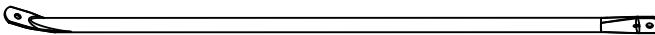

### TOOLS REQUIRED



1/2" Wrench (x2)



CCL-3/16" Allen Wrench  
(x2, included)



## TOOLS AND HARDWARE REQUIRED FOR THIS PAGE

### NO TOOLS REQUIRED FOR THIS PAGE

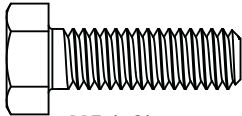

AAE (x2)

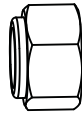

AAO (x2)

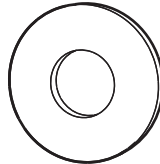

ABD (x4)

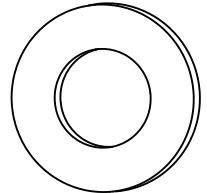

ABN (x2)

### SEC

#### 2.1

Attach the flattened end of the **Pole Brace (ALI)** to the **Base (AJM)** with the hardware shown. **Only finger tighten the hardware for now.**

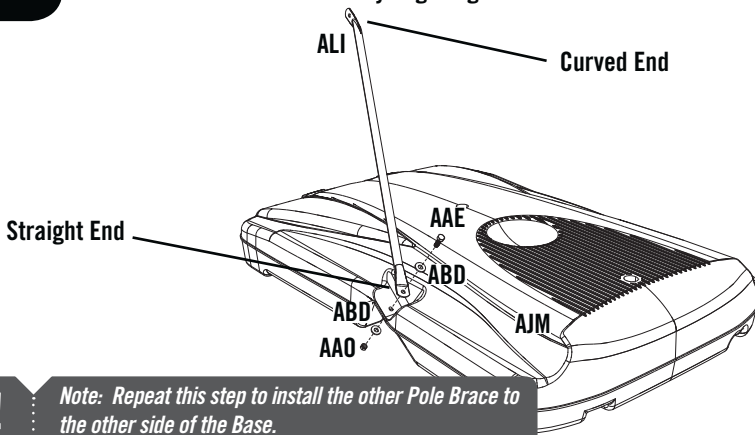

*Note: Repeat this step to install the other Pole Brace to the other side of the Base.*

### SEC

#### 2.2

Slide the  $\frac{1}{2}$ " x  $15 \frac{3}{4}$ " Axle (AJC) through the **Wheels (AMU)** and the holes at the end of the **Bottom Pole (ALE)** as shown. Slide the  $\frac{1}{2}$ " x 7" Axle (AJE) through the second set of holes near the end of the Bottom Pole as shown. Then slide two  $\frac{1}{2}$ " x  $\frac{1}{8}$ " Spacers (ABN) onto the  $\frac{1}{2}$ " x  $15 \frac{3}{4}$ " Axle and position them against the **Wheels**.

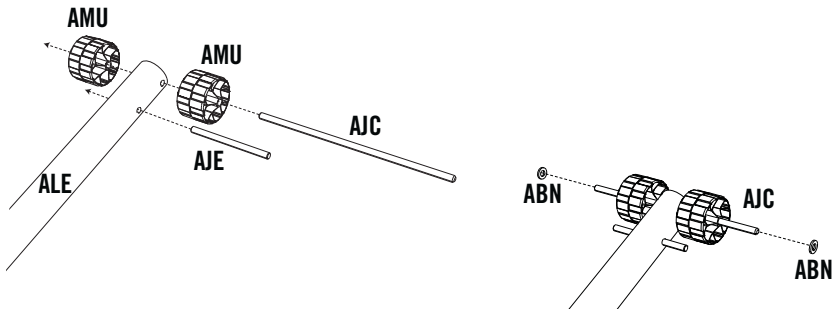



## TOOLS AND HARDWARE REQUIRED FOR THIS PAGE

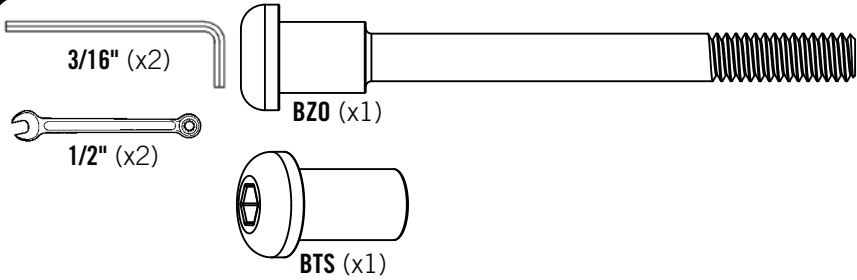

### SEC

#### 2.3

Place the Pole assembly on the ground with the Warning Sticker on the **Middle Pole (ALF)** facing down. Position the **1/2" x 15 3/4" Axle (AJC)** under the bottom slots of the **Base (AJM)** as shown, and step onto the Base so the Axle snaps into the slots. Then rotate the Pole assembly upward so that the **1/2" x 7" Axle (AJE)** snaps into the upper slots of the Base as shown.

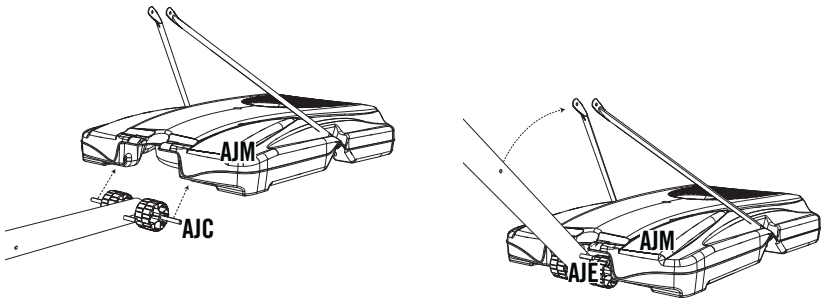

### SEC

#### 2.4

Attach the **Pole Braces (ALI)** to the **Bottom Pole (ALE)** with the hardware shown, and **tighten all Pole to Base assembly hardware**.

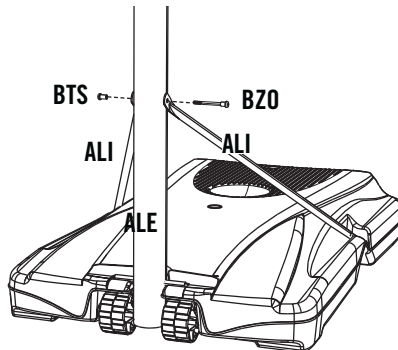

*Note: Tip the system forward so the Pole rests on the ground. Do not stand the system up until it is filled with either sand or water later in the assembly.*

## SEC 3 BACKBOARD TO RIM ASSEMBLY

### HARDWARE REQUIRED

Hardware shown at Actual Size

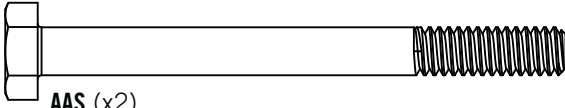

**AAS** (x2)  
1/4" x 2 3/4" Hex Bolt



**ABK** (x4)  
5/16" Nylon  
Flange Nut

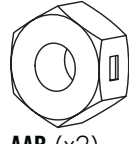

**AAB** (x2)  
1/4" Center-  
lock Nut

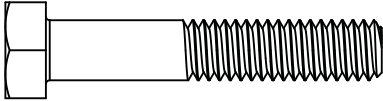

**AAC** (x2)  
5/16" x 1 3/4" Hex Bolt



**ABS** (x2)  
1/2" x 2 5/16" Galvanized Spacer

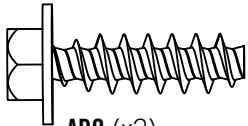

**ADQ** (x2)  
5/16" x 1" Screw

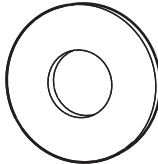

**ABD** (x4)  
5/16" Washer

Hardware shown at 25% of Actual Size



**AOX** (x1)  
Rim Support Channel

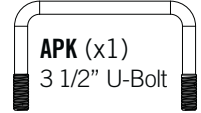

**APK** (x1)  
3 1/2" U-Bolt

### PARTS REQUIRED

Part shown at 25% of Actual Size

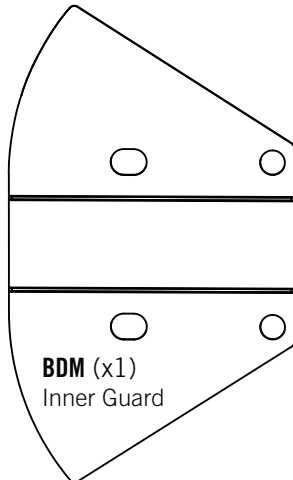

**BDM** (x1)  
Inner Guard

Part shown at 5% of Actual Size

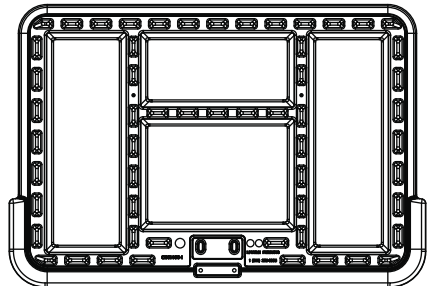

**AJI** (x1)  
Backboard

**SEC 3**

**BACKBOARD TO RIM ASSEMBLY**

***PARTS REQUIRED***

Parts shown at 10% of Actual Size



**AJK (x1)**  
Right Backboard Bracket



**AJJ (x1)**  
Left Backboard Bracket

**ALX (x1)**  
Rim

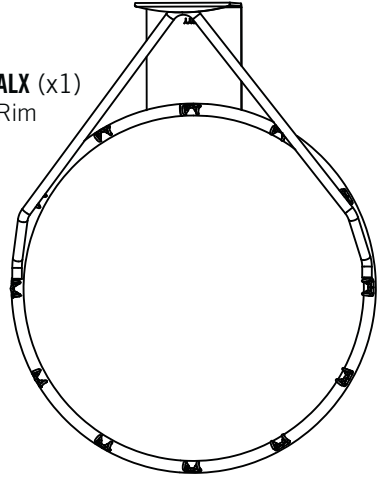

***TOOLS REQUIRED***



**1/2" Wrench (x2)**



**7/16" Wrench (x2)**



**3/8" Wrench**



## TOOLS AND HARDWARE REQUIRED FOR THIS PAGE

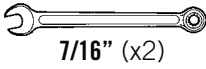

7/16" (x2)

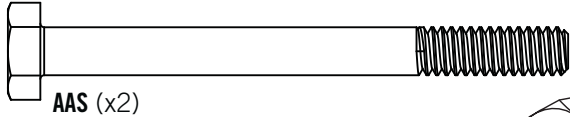

AAS (x2)



APK (x1)

(Not to scale)

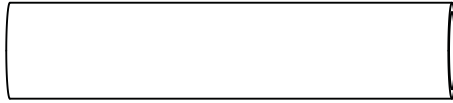

ABS (x2)

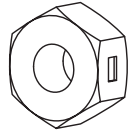

AAB (x2)

### SEC

#### 3.1

Slide the **3 1/2" U-Bolt (APK)** through the **Left and Right Backboard Brackets (AJJ & AJK)**. The U-Bolt must rest in the notches of the Backboard Brackets as shown.

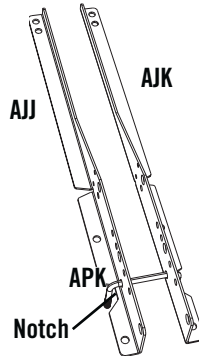
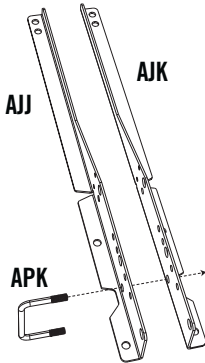

### SEC

#### 3.2

Fold up the sides of the **Inner Guard (BDM)** and place it between the Backboard Brackets as shown. Secure the Backboard Brackets to the Inner Guard using two **1/4" x 2 3/4" Hex Bolts (AAS)**, two **1/2" x 2 5/16" Galvanized Spacers (ABS)**, and two **1/4" Centerlock Nuts (AAB)**.

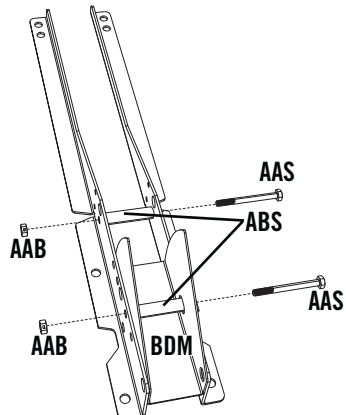
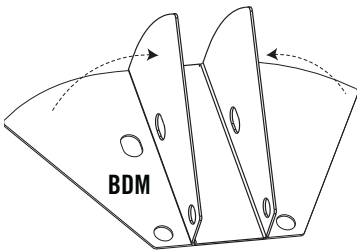

*Note: Tighten all Nuts securely now.*



## TOOLS AND HARDWARE REQUIRED FOR THIS PAGE

### NO TOOLS REQUIRED FOR THIS PAGE

AOX (x1)



(Not to scale)

SEC

3.3

Place the **Rim Support Channel (AOX)** into the recess on the backside of the **Backboard (AJI)** so that the flat side with holes is positioned against the Backboard as shown. Then insert the **3 1/2" U-Bolt (APK)** through the holes above the recess as shown.

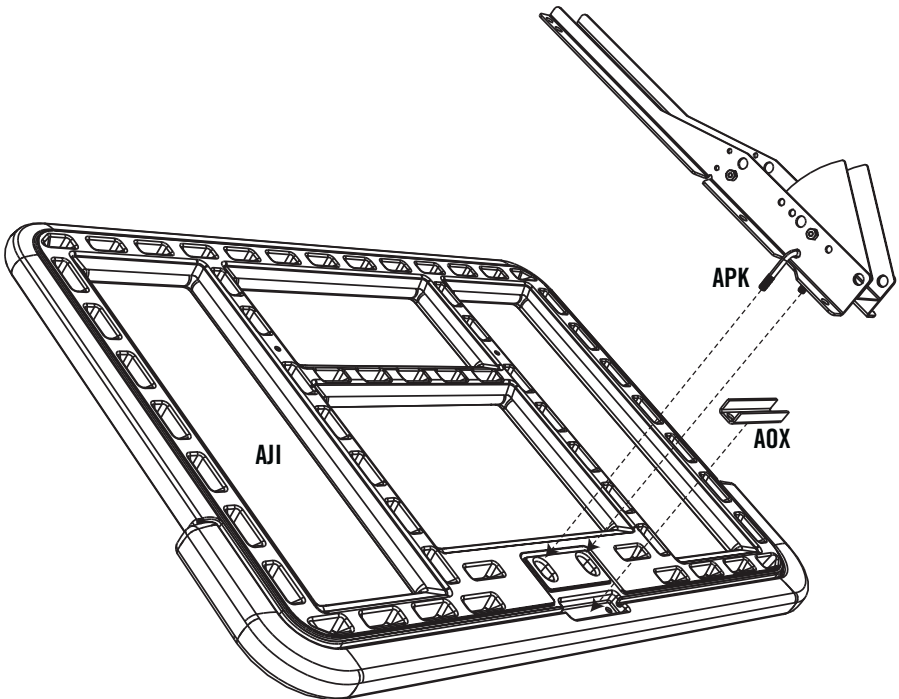



## TOOLS AND HARDWARE REQUIRED FOR THIS PAGE

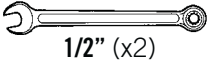

1/2" (x2)

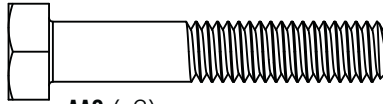

AAC (x2)



ABK (x4)

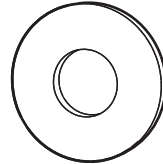

ABD (x4)

### SEC

### 3.4

Attach the **Rim (ALX)** to the **Backboard (AJI)** by securing two **5/16" Washers (ABD)** and two **5/16" Nylock Flange Nuts (ABK)** to the **3 1/2" U-Bolt (APK)**. Then insert two **5/16" x 1 3/4" Hex Bolts (AAC)** with **5/16"** Washers through the bottom holes of the Rim and Backboard and through the Rim Support Channel and Backboard Brackets, and secure with two **5/16"** Nylock Flange Nuts.

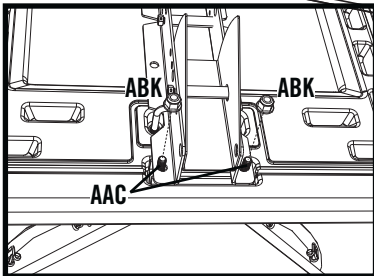
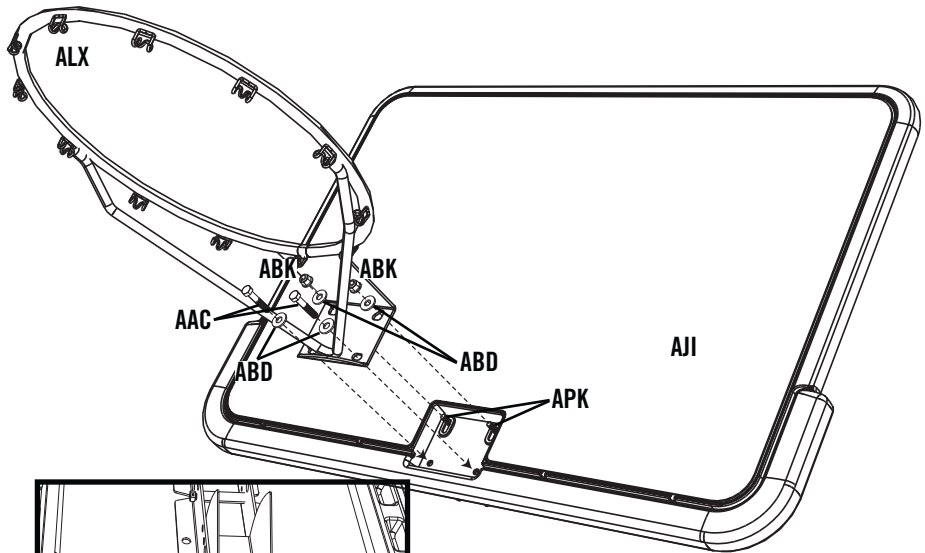

Underside View



*Note: Tighten the 5/16" Nylock Flange Nuts (ABK) until they are flush with the ends of the Bolts.*



## TOOLS AND HARDWARE REQUIRED FOR THIS PAGE

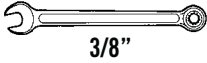

3/8"

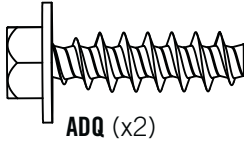

ADQ (x2)

SEC

3.5

Bend the **Left and Right Backboard Brackets (AJJ & AJK)** outward by hand and position the top holes in the Backboard Brackets over the holes in the **Backboard (AJI)**. Then securely fasten the Backboard Brackets to the Backboard with the hardware shown.

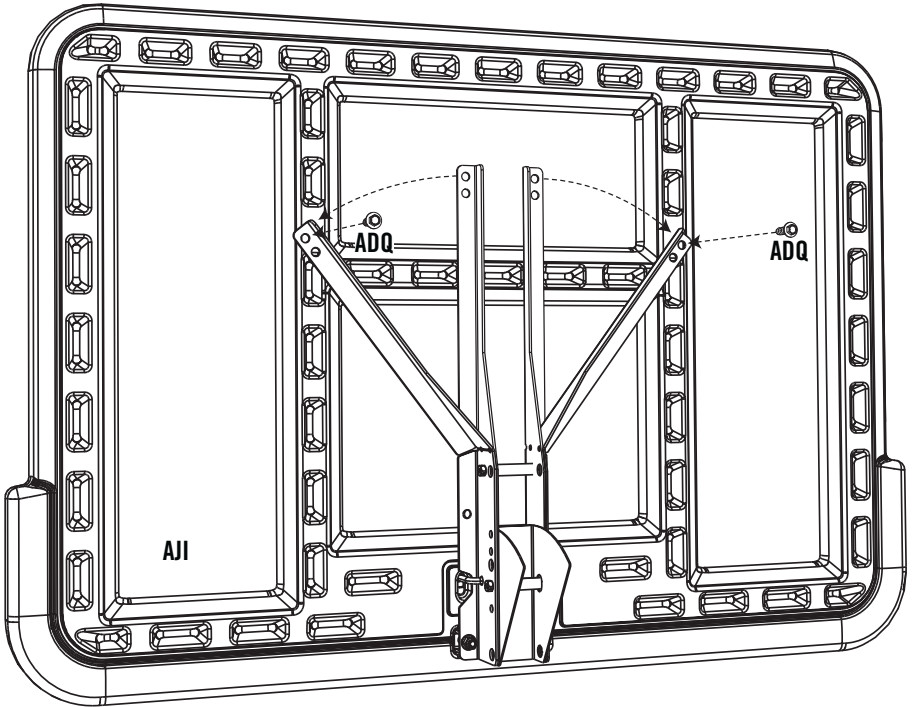

# SEC 4 BACKBOARD TO POLE ASSEMBLY

## HARDWARE REQUIRED

Hardware shown at Actual Size

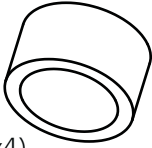

**ABP (x4)**  
1/2" x 3/8" Clear Poly Spacer

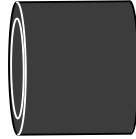

**ABL (x4)**  
.69" x .59" Black Spacer

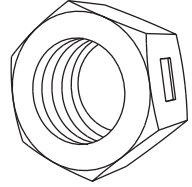

**AAX (x4)**  
1/2" Centerlock Nut

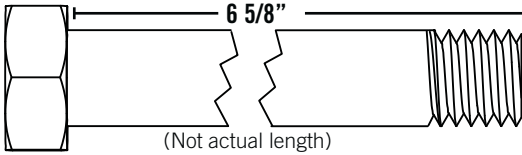

**ADG (x4)**  
1/2" x 6 5/8" Hex Bolt

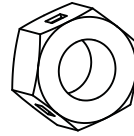

**ABB (x1)**  
3/8" Centerlock Nut

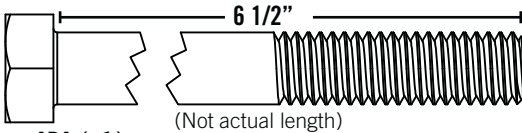

**ABA (x1)**  
3/8" x 6 1/2" Hex Bolt

## PARTS REQUIRED

Parts shown at 10% of Actual Size

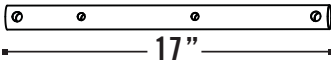

**AKC (x4)**  
Extension Arm

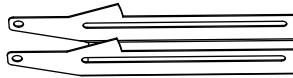

**BDN (x1)**  
Outer Guard



**BDL (x1)**  
Dunk Latch

## TOOLS REQUIRED



**3/4" Wrench (x2)**



**9/16" Wrench (x2)**



**Rubber Mallet**



## TOOLS AND HARDWARE REQUIRED FOR THIS PAGE

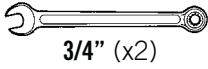

3/4" (x2)

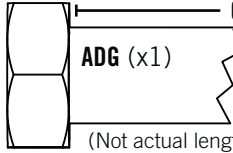

ADG (x1)

(Not actual length)

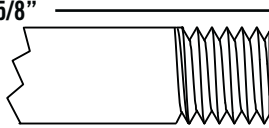

6 5/8"

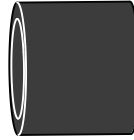

ABL (x2)

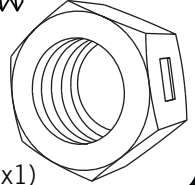

AAX (x1)

### SEC

#### 4.1

Secure two of the **Extension Arms (AKC)** to the Backboard Brackets in the location shown with the hardware indicated. Make sure to attach the end of the Extension Arms with one hole to the Backboard Brackets as shown.

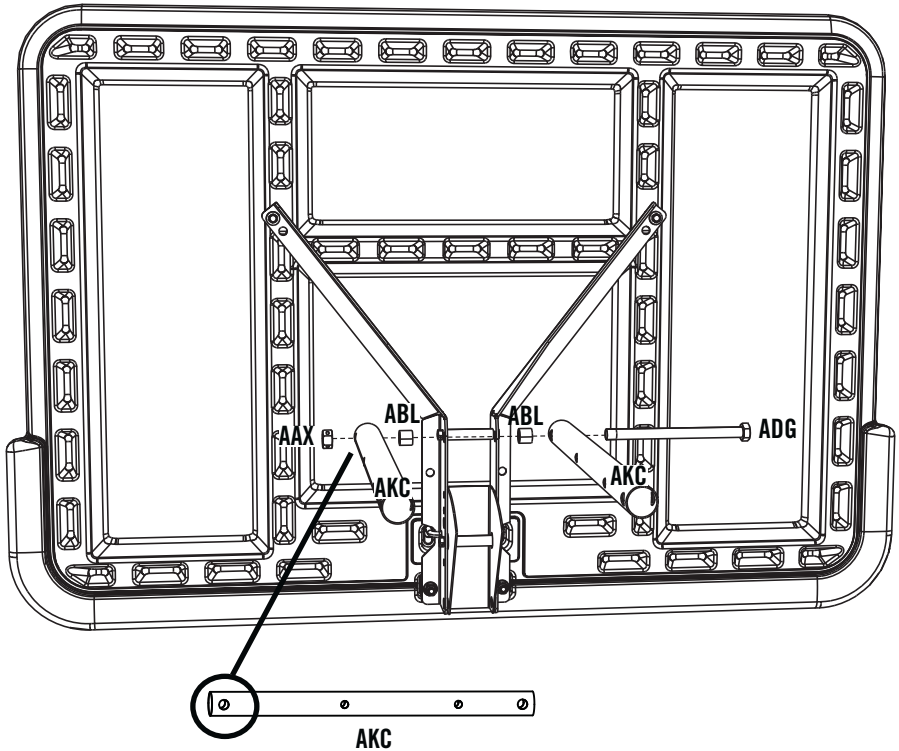

*Note: Tighten the 1/2" Centerlock Nut (AAX) until it is flush with the end of the Bolt.*



## TOOLS AND HARDWARE REQUIRED FOR THIS PAGE

### NO TOOLS OR HARDWARE REQUIRED FOR THIS PAGE

SEC

4.2

Place the **Dunk Latch (BDL)** within the **Outer Guard (BDN)** and align the holes at the end. Then position the Dunk Latch and Outer Guard onto the Backboard Bracket Assembly as shown. The Dunk Latch fits within the **Inner Guard (BDM)** and the Outer Guard fits between the Inner Guard and the Backboard Brackets.

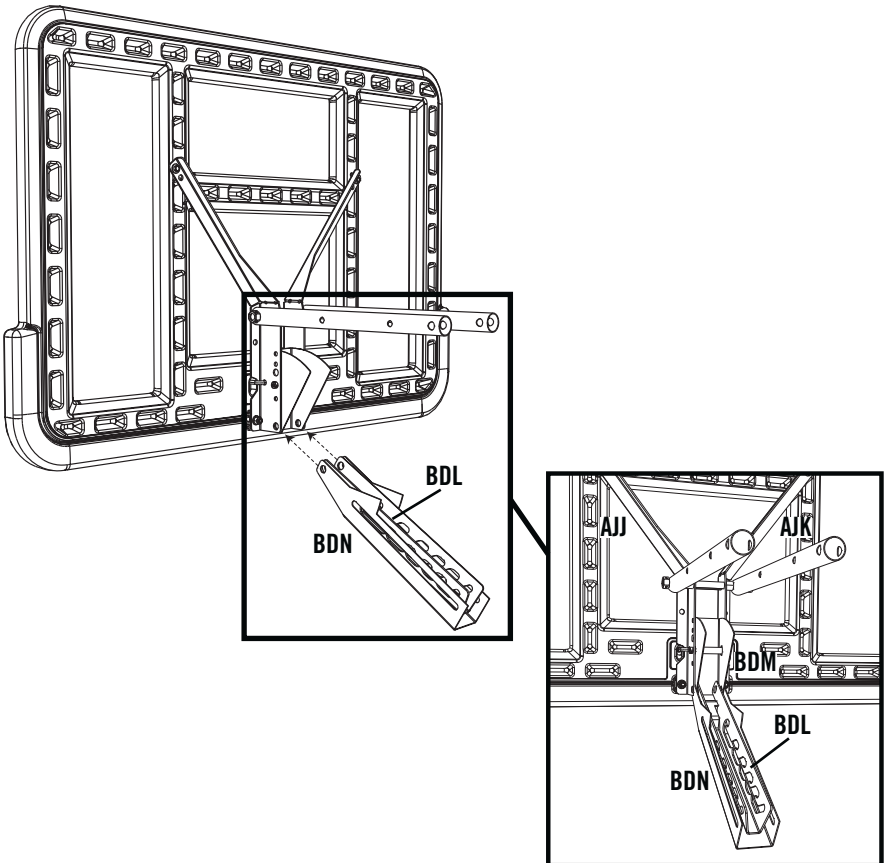



## TOOLS AND HARDWARE REQUIRED FOR THIS PAGE

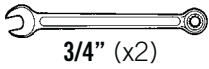

3/4" (x2)

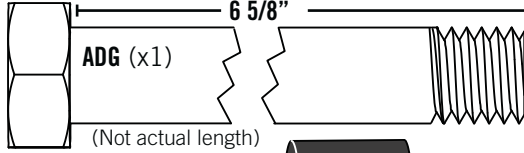

ADG (x1)

6 5/8"

(Not actual length)

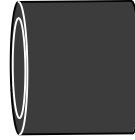

ABL (x2)

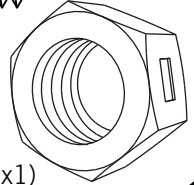

AAX (x1)

### SEC

### 4.3

Secure the **Dunk Latch (BDL)**, **Outer Guard (BDN)**, and the other two **Extension Arms (AKC)** to the Backboard Brackets in the location shown with the hardware indicated.

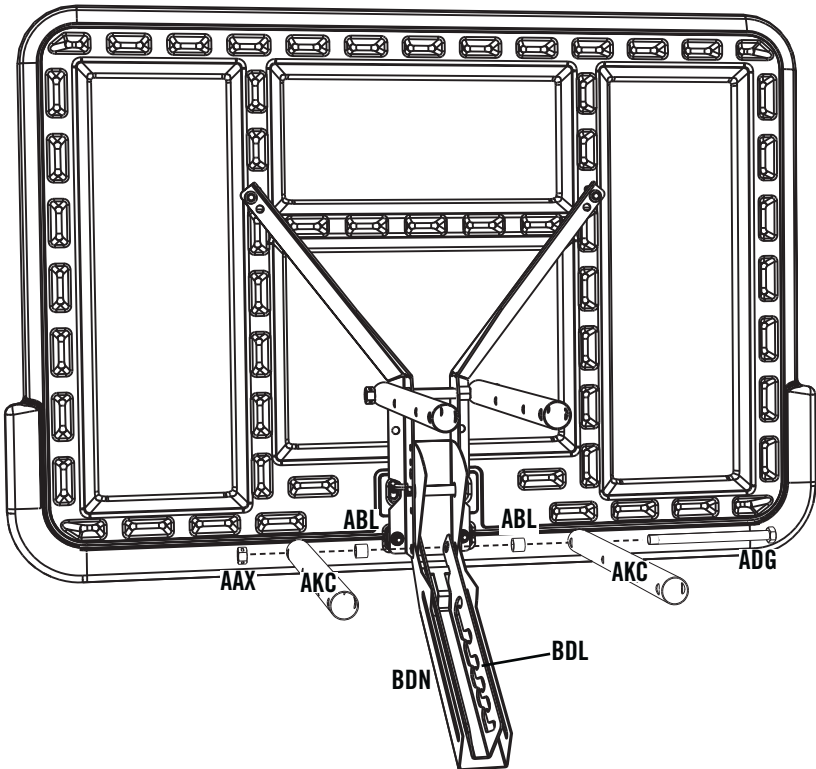

*Note: Tighten the 1/2" Centerlock Nut (AAX) until it is flush with the end of the Bolt.*



## TOOLS AND HARDWARE REQUIRED FOR THIS PAGE

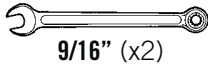

9/16" (x2)

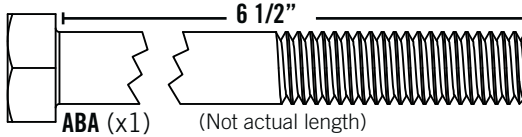

ABA (x1)

(Not actual length)



ABB (x1)

SEC

4.4

Lift the **Dunk Latch (BDL)** and **Outer Guard (BDN)** so the slots line up with the holes in the upper **Extension Arms (AKC)** that are closest to the **Backboard (AJI)**. Then secure the Dunk Latch and Outer Guard to the upper Extension Arms with the hardware shown.

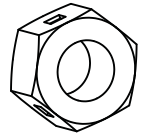
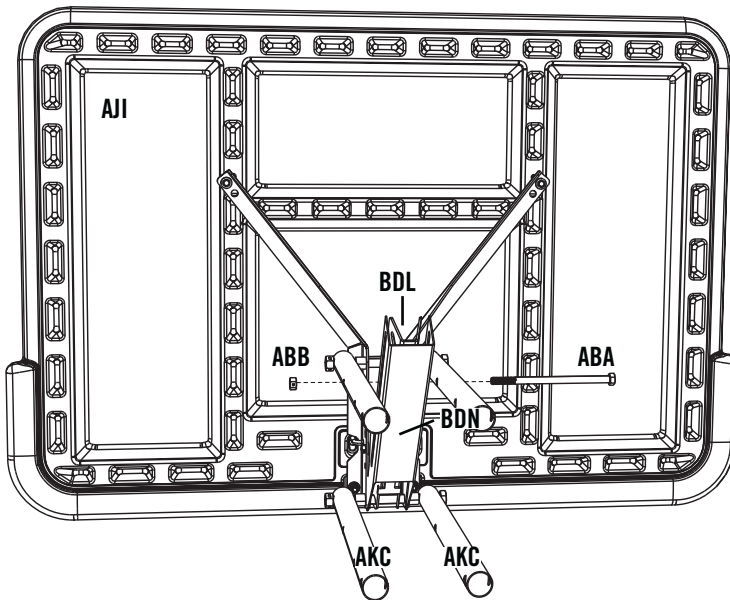

## WARNING

Do not operate the system without the Outer Guard in place over the Dunk Latch. Doing so could increase the risk of injuries described on Page Three. If the Outer Guard becomes loose or detached, call our Customer Service Department.



*Note: Tighten the 3/8" Centerlock Nut (ABB) until it is flush with the end of the Bolt.*



## TOOLS AND HARDWARE REQUIRED FOR THIS PAGE

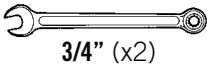

3/4" (x2)

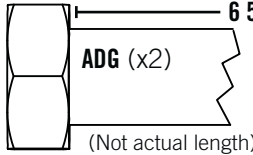

ADG (x2)

(Not actual length)

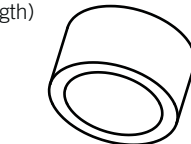
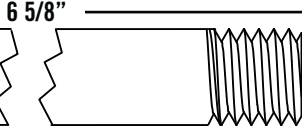

ABP (x4)

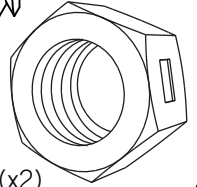

AAX (x2)

SEC

4.5



**CAUTION: HAVE ONE ADULT HOLD THE BACKBOARD IN PLACE UNTIL THIS STEP HAS BEEN COMPLETED!**



Lay the Backboard and Rim assembly next to the Pole assembly. Rest the Rim on cardboard to prevent scratching. Then secure the **Extension Arms (AKC)** to the Pole Assembly with the hardware shown.

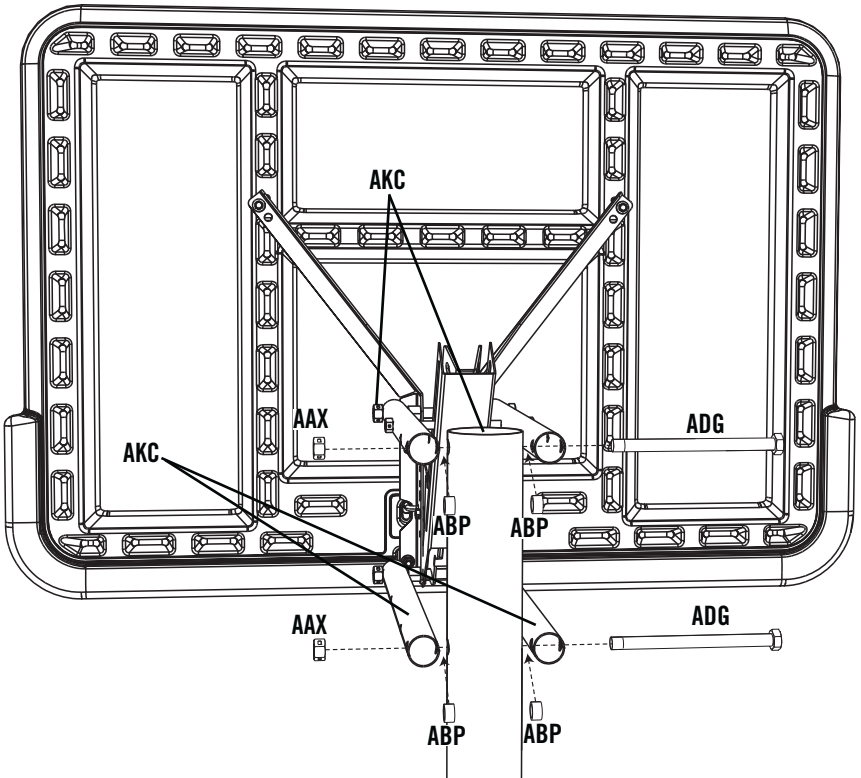

*Note: Tighten the 1/2" Centerlock Nuts (AAX) until they are flush with the end of the Bolts. Make sure all hardware is securely tightened before moving to the next section.*

**SEC 5 FINAL ASSEMBLY**

***HARDWARE REQUIRED***

***NO HARDWARE REQUIRED FOR THIS SECTION***

***PARTS REQUIRED***

Part shown at 10% of Actual Size

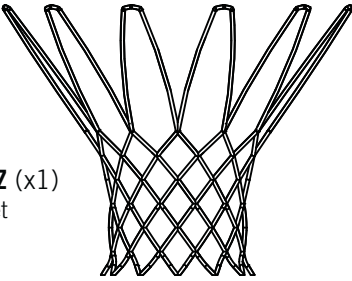

**AKZ (x1)**  
Net

Part shown at Actual Size

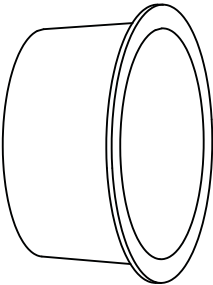

**AEF (x2)**  
Base Plug

***TOOLS REQUIRED***

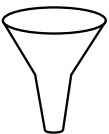

**Funnel**



**Sand**  
(362 lb)



**Water Hose**



## TOOLS AND HARDWARE REQUIRED FOR THIS PAGE

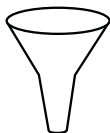

(362 lb)

### NO HARDWARE REQUIRED FOR THIS PAGE

**Two adults are required to complete assembly. To prevent serious injuries, the Pole should be held down by one adult at all times while the Base is being filled.**

## SEC

### 5.1

#### OPTION A: FILLING WITH SAND

(362 lb of sand required)

- Insert a **Base Plug (AEF)** into the **Base (AJM)** in the hole closest to the Pole.
- Using a funnel, fill the Base with sand through the hole furthest from the Pole until the sand is just below the hole.
- Using two adults, stand the Base up on a flat surface and finish filling the Base with sand.
- Insert the other Base Plug into the hole furthest from the Pole.



## WARNING

For safety reasons, we recommend that sand be used instead of water to fill the Base. If a leak develops, water could run out unnoticed, allowing the system to fall over, resulting in serious personal injuries, or property damage. If using Water, check the Base carefully for leaks. If a leak is found, lay the system down on the ground and call Customer Service. Do not use, stand up, or play on a leaking system.





## TOOLS AND HARDWARE REQUIRED FOR THIS PAGE



### NO HARDWARE REQUIRED FOR THIS PAGE

**Two adults are required to complete assembly. To prevent serious injuries, the Pole should be held down by one adult at all times while the Base is being filled.**

#### SEC

#### 5.1

#### OPTION B: FILLING WITH WATER

- Insert a **Base Plug (AEF)** into the **Base (AJM)** in the hole closest to the Pole.
- Fill the Base with cold water through the hole furthest from the Pole until the water is just below the hole.
- Using two adults, stand the Base up on a flat surface and finish filling the Base with water.
- Add one tablespoon of chlorine bleach to the water to prevent algae formation.
- Insert the other Base Plug into the hole furthest from the Pole.

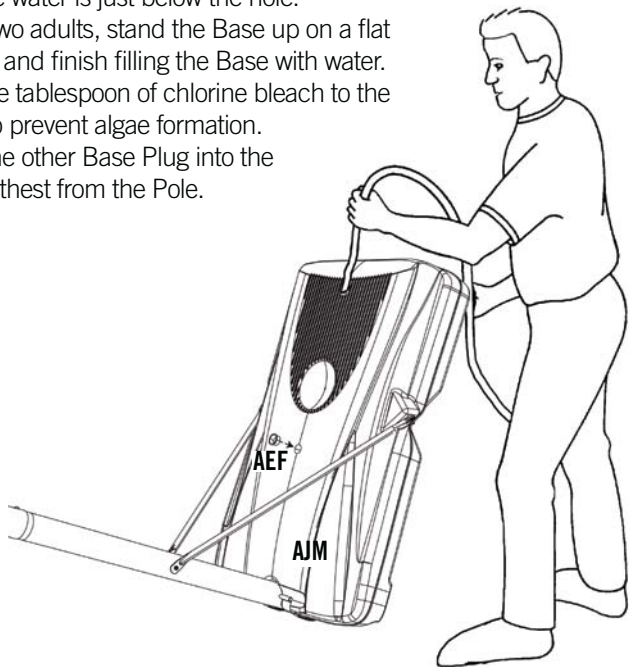



## TOOLS AND HARDWARE REQUIRED FOR THIS PAGE

**NO TOOLS OR HARDWARE REQUIRED FOR THIS PAGE**

**SEC**

**5.2**

Attach **Net (AKZ)** to the **Rim (ALX)**.

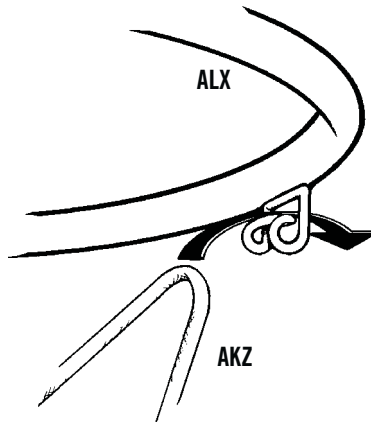

*Note: If a replacement Net is needed, please call our Customer Service Department. Our Nets are shorter than average to reduce the risk of entanglement.*

## OPERATION OF HEIGHT ADJUSTMENT SYSTEM

The basketball system may be adjusted from 8 feet to 10 feet.  
ONLY ADULTS SHOULD ADJUST THE HEIGHT OF THE SYSTEM.

### To Raise the Hoop:

- Place the end of a long object, such as a broom handle, under the Rim and push upward.



Raise

### To Lower the Hoop:

- Place the broom handle behind the Backboard and push upward into the release box. Carefully support the weight as you lower the system.



Lower

## MOVING THE SYSTEM



**WARNING:** The system must only be moved by people capable of handling its weight. Children should not be allowed to move the system.

- Adjust the system to its lowest position, and use caution to prevent the height mechanism from adjusting.
- Stand in front of the system and pull on the Pole until the unit is balanced on its Wheels.
- Move the system to the desired location and carefully set the Base down.



**CAUTION:** The system must only be moved on its Wheels. Sliding the Base may damage the Base which could result in leakage and the system tipping over.

## ***POLE CARE AND SYSTEM MAINTENANCE***

The life of your basketball system depends on many variables. The climate, exposure to corrosives such as salt, pesticides, or herbicides, and excessive use or misuse can all contribute to Pole failure, which may cause property damage or personal injury.

Check your basketball system frequently for loose hardware, excessive wear, and signs of corrosion. For safety reasons, and to prolong the life of your basketball system, you must take the following preventive measures.

- a. Check all Nuts and Bolts. If any are loose, tighten them.
- b. Check all parts for excessive wear and tear. If necessary, replace any parts that have been worn or damaged through usage. Contact our Customer Service Department for replacement parts.
- c. Inspect the Warning Sticker on the Pole. If it is ripped, faded, or illegible, call our Customer Service Department to request a replacement Sticker.
- d. Check all Pole sections for visible rust or chipped or cracked paint. If either are present, do the following:
  1. Use an emery cloth to completely remove any rust or chipped paint.
  2. Clean the area with a damp cloth and allow it to dry.
  3. Apply two coats of a rust preventative, high gloss enamel paint to the area. Allow the paint to dry between coats.

**IF RUST HAS PENETRATED THROUGH THE POLE ANYWHERE, REPLACE IT IMMEDIATELY!**

*NOTES*

**ENHANCE YOUR LIFETIME® PURCHASE BY ADDING  
ACCESSORIES OR OTHER GREAT PRODUCTS:**

*To purchase accessories or other Lifetime Products, visit us at:*

***[www.lifetime.com](http://www.lifetime.com)***

***Or call: 1-800-424-3865***

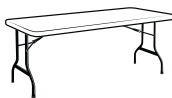
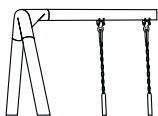



## WARNING



### FAILURE TO FOLLOW THESE WARNINGS MAY RESULT IN SERIOUS INJURY AND/OR PROPERTY DAMAGE.

- Owners must ensure that all players know and follow these rules for safe operation of the system.
- Only hang from the rim briefly to regain balance or avoid injuring others. Release the rim as soon as safely possible.
  - During play, especially when performing dunk type activities, keep player's face away from the backboard, rim, and net. Serious injury could occur if teeth/face come in contact with the backboard, rim, or net. Player should wear a mouth guard during play.
  - Do not slide, climb, or play on base or pole.
  - Completely fill base according to manufacturer's instructions. Never leave the unit standing in an upright position without first filling the base with weight or the system will tip quickly causing serious personal injury.
  - When adjusting height or moving system, keep hands and fingers away from moving parts.
  - Do not allow children to move or adjust system.
  - Do not wear jewelry (rings, watches, necklaces, etc.) during play. Objects may entangle in net.
  - Keep organic material away from pole base. Grass, litter, etc. could cause corrosion and/or deterioration.
  - Surface beneath the base must be smooth and free of gravel or other objects. Punctures cause leakage and could cause system to tip over.
  - Once a month check pole and all metal parts for signs of corrosion (rust, pitting, chipping). Completely remove rust and repaint with exterior enamel. If rust has penetrated any steel part, replace that part immediately.
  - Check system before each use for proper ballast, loose hardware, excessive wear, instability, and signs of corrosion and repair before use.
  - Never play on damaged equipment.
  - Do not use system during windy or severe weather. System may tip over. Place system in an area protected from the wind or in an area away from property that may be damaged if the system falls, and from overhead power lines.
  - Do not use the system to lift or hoist anything. The mechanism is designed to lift only the weight of the backboard and rim. Do not hang anything from the handle, rim backboard, or lifter arms as this will damage the system and void the warranty.



## ADVERTENCIA



## AVERTISSEMENT



### SI NO SE OBEDECEN ESTAS ADVERTENCIAS PUEDEN PRODUCIRSE GRAVES LESIONES Y/O DAÑOS A LA PROPIEDAD.

### FAUTE DE NE PAS SUIVRE CES AVERTISSEMENTS, VOUS RISQUEZ DE CAUSER DES BLESSURES GRAVES ET/OU DES DOMMAGES A L'EQUIPEMENT.

- El propietario del sistema debe asegurarse de que todos los jugadores conozcan y respeten estas reglas para que el sistema se use en forma segura.
- Le propriétaire doit s'assurer que tous les joueurs connaissent et appliquent les règles suivantes afin d'utiliser l'équipement en toute sécurité.
- Cuélguese del aro sólo en forma breve, para recuperar el equilibrio o evitar lesionar a otros jugadores. Suéltese del aro lo más pronto que pueda hacerlo con seguridad.
  - Durante el juego, especialmente en el embocar violentamente de alto, la cara de los jugadores debe mantenerse alejada del tablero, el aro y la red. Pueden producirse lesiones graves si los dientes o la cara entran en contacto con el tablero, el aro o la red. Los jugadores deben usar un protector bucal durante el juego.
  - No se deslice, no trepe ni juegue sobre la base o el poste.
  - Llene la base completamente siguiendo las instrucciones del fabricante. Nunca deje la unidad en posición de uso sin haber llenado previamente la base con material de contrapeso, pues el sistema podría tumbarse rápidamente y causar graves lesiones personales.
  - Mantenga las manos y los dedos alejados de las piezas móviles cuando regule la altura o desplace el sistema.
  - No deje que los niños regulen ni desplacen el sistema.
  - No use joyas (anillos, relojes, collares o gargantillas, etc.) durante el juego. Estos objetos pueden engancharse en la red.
  - La superficie donde se coloque la base debe estar lisa y desprovista de piedras, grava u otros objetos. Las perforaciones pueden originar pérdidas, y éstas pueden hacer que el sistema se tumbe.
  - No permita que la base del poste entre en contacto con materiales orgánicos. El pasto, los desechos animales, etc., pueden causar corrosión y/o deterioros.
  - Controle el poste y todas las piezas metálicas una vez al mes en busca de signos visibles de corrosión (oxidación, picaduras, escamado). Elimine todo rastro de óxido y vuelva a pintar con esmalte para exteriores. Si el óxido ha penetrado cualquier pieza de acero, reemplace esa pieza de inmediato.
  - Inspeccione el sistema antes de cada uso para verificar que esté adecuadamente contrapesado, que los elementos de fijación no estén flojos, que no haya desgaste excesivo, inestabilidad ni signos de corrosión. Si encuentra irregularidades, repárelas antes de usar el sistema.
  - Nunca juegue con un equipo dañado.
  - No use el sistema en presencia de vientos fuertes o condiciones climáticas adversas, ya que puede tumbarse. Coloque la unidad en su posición de almacenamiento y/o en una zona a resguardo del viento, lejos de propiedades personales que puedan dañarse si el sistema se cae, y de líneas de suministro de energía.
  - No use el sistema para levantar ningún objeto. El mecanismo está diseñado para elevar solamente el peso del tablero con el aro. No cuelgue nada de la arañadora, el aro, el tablero ni los brazos de elevación, ya que esto puede dañar el sistema y anular la garantía.
  - Ne vous suspendez pas à l'anneau plus que nécessaire pour retrouver votre équilibre ou éviter de blesser les autres joueurs. Relâchez l'anneau aussitôt que possible.
  - Lors d'un match, particulièrement dans le cas des smashes, le visage du joueur ne doit pas faire face au panneau, à l'anneau, ni au filet. Le joueur risque de graves blessures si ses dents ou son visage entrent en contact avec le panneau, l'anneau, ou le filet. Les joueurs doivent toujours porter un protège-dents lorsqu'ils jouent.
  - Ne glissez pas, ne grimpez pas, et ne jouez pas sur la base ou le poteau.
  - Remplissez complètement la base selon les instructions du fabricant. Ne laissez jamais l'unité debout de plein pied sans avoir d'abord rempli la base avec un poids ou l'équipement pourrait basculer rapidement et causer de graves blessures.
  - Lorsque vous ajustez la hauteur ou lorsque vous déplacez l'équipement, gardez vos mains et doigts loin des pièces mobiles.
  - Ne permettez pas aux enfants de déplacer ou d'ajuster l'équipement.
  - Ne portez pas de bijoux (bagues, montres, colliers, etc.) lorsque vous jouez. Ces objets pourraient s'accrocher au filet.
  - La surface sur laquelle est posée la base doit être lisse et sans gravier ou tout autre objet qui pourrait troubler la base entraînant ainsi une fuite ce qui pourrait faire basculer l'équipement.
  - La base ne doit pas non plus être posée sur aucun type de matière organique. L'herbe, les déchets, etc. peuvent entraîner la corrosion et la détérioration de l'équipement.
  - Une fois par mois, vérifiez que le Poteau et toutes les pièces en métal ne montrent pas de signes de corrosion (rouille, piqûres, écaillage). Enlevez toute la rouille et repeignez complètement avec une peinture pour extérieur. Si la rouille a pénétré une des pièces en acier, vous devez remplacer immédiatement la pièce en question.
  - A chaque fois que vous allez utiliser l'équipement, vérifiez d'abord l'équilibre, la possibilité de pièces desserrées ou usées, la stabilité de l'équipement et tout signe de corrosion ou réparation nécessaire avant utilisation.
  - Ne jouez jamais avec un équipement endommagé.
  - N'utilisez pas l'équipement lors de fortes rafales de vent ou de mauvais temps. L'équipement pourrait basculer. Placez l'équipement dans un endroit abrité du vent ou loin des structures qu'il pourrait endommager s'il basculait et loin des fils électriques.
  - N'utilisez pas l'équipement pour lever ou soulever quoique ce soit. Son mécanisme a été conçu uniquement pour soutenir le poids du panneau et de l'anneau. N'accrochez rien au manche, à l'anneau, au panneau ni aux leviers sous peine d'endommager l'équipement et d'annuler la garantie.

#FS16400

10/12/2004

[www.lifetime.com](http://www.lifetime.com)

## **WARRANTY INFORMATION**

### **LIFETIME BASKETBALL EQUIPMENT**

#### **5-YEAR LIMITED FACTORY WARRANTY**

**THE MANUFACTURER RESERVES THE RIGHT TO MAKE SUBSTITUTIONS TO WARRANTY CLAIMS IF PARTS ARE UNAVAILABLE OR OBSOLETE.**

1. Lifetime basketball systems are warranted to the original purchaser to be free from defects in material or workmanship for a period of five years from the date of original retail purchase. The word "defects" is defined as imperfections that impair the use of the product. Defects resulting from misuse, abuse or negligence will void this warranty. This warranty does not cover defects due to improper installation, alteration or accident. This warranty does not cover damage caused by vandalism, rusting, "acts of nature" or any other event beyond the control of the manufacturer.
2. This warranty is nontransferable and is expressly limited to the repair or replacement of defective basketball equipment. If the equipment is defective within the terms of this warranty, Lifetime Products, Inc. will repair or replace defective parts at no cost to the purchaser. Shipping charges to and from the factory are not covered and are the responsibility of the purchaser. Labor charges and related expenses for removal, installation or replacement of the basketball system or its components are not covered under this warranty.
3. This warranty does not cover scratching or scuffing of the product that may result from normal usage. In addition, defects resulting from intentional damage, negligence, unreasonable use or hanging from the net or rim will void this warranty.
4. Liability for incidental or consequential damages is excluded to the extent permitted by law. While every attempt is made to embody the highest degree of safety in all equipment, freedom from injury cannot be guaranteed. The user assumes all risk of injury resulting from the use of this product. All merchandise is sold on this condition, and no representative of the company may waive or change this policy.
5. This product is not intended for institutional or commercial use; Lifetime Products, Inc. does not assume any liability for such use. Institutional or commercial use will void the warranty.
6. This warranty is expressly in lieu of all other warranties, expressed or implied, including warranties of merchantability or fitness for use to the extent permitted by Federal and state law. Neither Lifetime Products, Inc., nor any representative assumes any other liability in connection with this product. This warranty gives you specific legal rights, and you may also have other rights which vary from state to state.

**ALL WARRANTY CLAIMS MUST BE ACCOMPANIED BY A SALES RECEIPT.**

**REPORT PRODUCT DEFECTS IN WRITING TO:**

Lifetime Products, Inc., PO Box 160010 Clearfield, UT 84016-0010, or call (800) 225-3865

M-F 7 a.m. to 5 p.m. MST.

**\*\*Call or visit our Web site for Saturday hours\*\***

Please include your dated sales receipt and photographs of damaged parts.

**To register the product, visit our Web site at [www.lifetime.com](http://www.lifetime.com)**



[www.lifetime.com](http://www.lifetime.com)