

STS Installation Manual



1 Locate the cable coming from left handlebar switch and find an accessible spot.



2 Remove main insulation, locate and cut 3 wires (left, right and flasher signal wire), and crimp red bullet connectors. Then locate power supply* (12 V and GND).

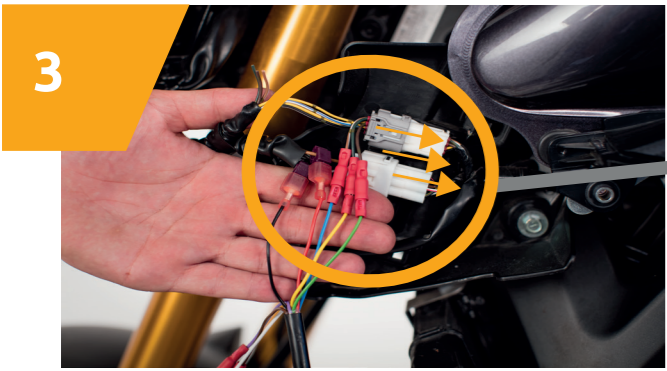

3 Connect power supply* with violet TAB connectors (12 V, GND). Then connect green, yellow and blue STS wire with wires going to motorcycle**.

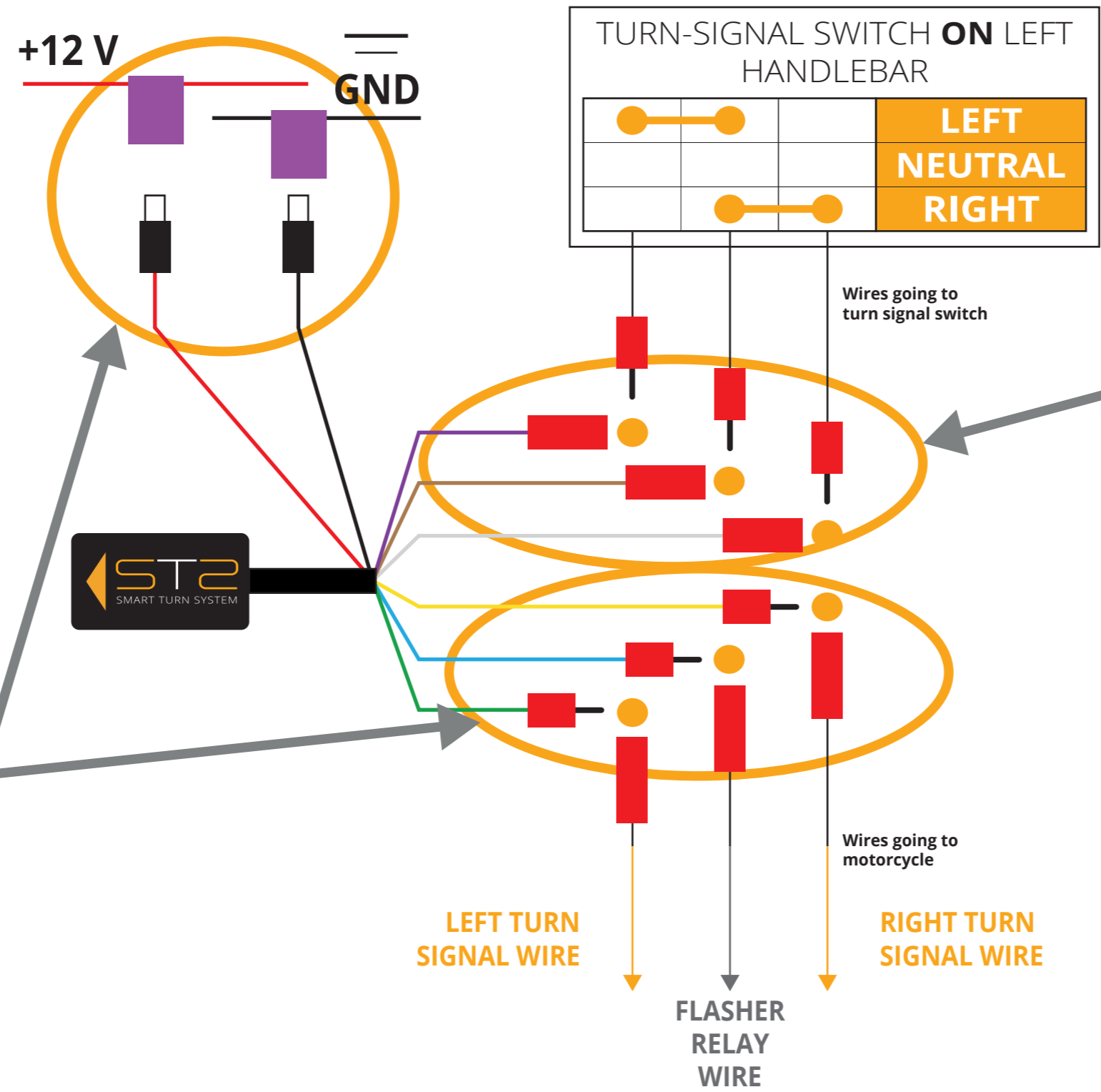

4 Insert supplied foams into turn signal switch. [More info](#)

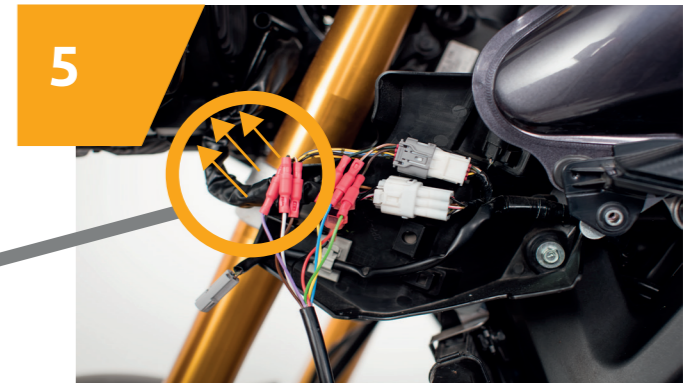

5 Connect remaining 3 STS wires (white, brown and purple) with wires going to left handlebar switch (left, right and flasher signal wire).

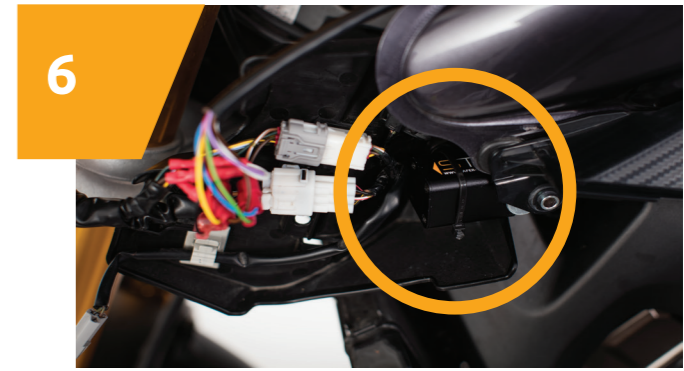

6 Attach the STS unit to firm mounting spot. Logo **must** be pointing upwards and arrow in driving direction. [More info](#)

! *Power supply must be taken from ACC wire (ignition key switch 12 V), **not** permanent 12 V from battery.

! **As soon you connect the five wires and turn the ignition on, left and right flash will appear. **Do not** proceed with installation process if you don't see flashes!

! **Do not connect white, brown and purple STS wire in this step! These three wires will be connected in the one of the next steps.**

Reassemble all components back to its original place and ride safer with:

IMPORTANT! Colours listed in the chart below are informative and may not be the same as on your motorcycle. Please check in your service / repair manual before starting the installation.

Universal wire colour chart

STS	COLOUR	CONNECTOR	HONDA	YAMAHA	KAWASAKI	SUZUKI	VESPA	TRIUMPH
POWER SUPPLY (+12V)	Red	FASTON MALE	/	/	/	/	/	/
GROUND (GND)	Black	FASTON MALE	Green	/	/	/	Black	/
WIRE TO MOTORCYCLE:								
RIGHT TO MOTORCYCLE	Yellow	MALE BULLET	Light Blue	Dark Green	Gray	Light Green	White / Blue	Gray
SIGNAL TO MOTORCYCLE	Blue	MALE BULLET	Gray	Brown/White	Orange	Light Blue	Blue / Black	Orange
LEFT TO MOTORCYCLE	Green	MALE BULLET	Orange	Chocolate	Green	Black	Pink	Green
WIRE TO TURN SIGNAL SWITCH:								
RIGHT HANDLEBAR		FEMALE BULLET	Light Blue	Dark Green	Gray	Light Green	White / Blue	Gray
SIGNAL HANDLEBAR		FEMALE BULLET	Gray	Brown/White	Orange	Light Blue	Blue / Black	Orange
LEFT HANDLEBAR		FEMALE BULLET	Orange	Chocolate	Green	Black	Pink	Green

Watch the installation video



<https://www.youtube.com/watch?v=Pg693JMENfY>

Attach STS unit to firm mounting spot

- STS unit has approx. 40 cm (16") of cable so it must be located near listed wires on a motorcycle.
- The mounting spot for the STS unit should be flat and fairly horizontal.
- The STS device should be fixed to the chassis, not on the rudder or any other moving part of the motorcycle.
- It is recommended to fix the STS module with ZIP Ties, so try to find a spot that allows this and attach it firmly.
- The module must be installed with the STS logo facing upwards.
- The arrow of the STS Logo must be pointing forward (in driving direction).
- If necessary use velcro or industrial double-side tape (not included) to ensure a secure mounting.
- Mount the unit away from heat sources, such as the engine or exhaust.

How it works? - User manual

- STS recognizes and differentiates:
 - Left or right turn
 - Changing lane
 - Roundabout
 - Overtaking
- When you activate the left or right turn-signal lever, the turn-signal will start flashing.
- If you want to cancel the turn-signals, push the lever to the same side again.
- After each manoeuvre the cancels turn-signal automatically.
- STS recognizes when the vehicle is stationary and will not cancel the turn-signal.
- If STS does not cancel the turn-signal after the actual manoeuvre, the in-built timer will cancel the turn-signal after 15 seconds of driving.

Disclaimer
 To the maximum extent permitted by applicable law neither Movalyse d.o.o. nor its suppliers, its subcontractors, its affiliates, officers, directors, employees, dealers or agents shall be liable to you or to any third party for any incidental damage including personal injury or any other damages, whether direct, special, incidental, indirect or consequential arising out of or related to:

- Smart Turn System not working correctly due to improper calibration of the system and/or any other usage that is not in comply to Smart Turn System user manual.
- Damage made on motorcycle due to improper installation and/or improper use of Smart Turn System.
- Turn-signals not blinking due to improper installation or calibration.
- Smart Turn System not cancelling turn-signals after the end of manoeuvre or turn-signals cancelling prematurely (during drive/before manoeuvre is completed).

Smart Turn System is a device that assist motorcyclist to cancel turn-signals after the end of manoeuvre. Smart Turn System can detect manoeuvre and cancels turn-signals after the manoeuvre is completed. Due to various driving styles and motorcycle types company Movalyse d.o.o. can take no responsibility if Smart Turn System doesn't detect manoeuvre and consequently doesn't cancel turn-signals after any manoeuvre. Furthermore Movalyse d.o.o. can take no responsibility if turn-signals are cancelled prematurely. Correct turn-signal usage is motorcyclist responsibility and STS device is meant only to assist rider with turn-signal cancellation.

Modify turn-signal switch from latching to momentary

Type 1:
 Honda, Yamaha, Suzuki, Kawasaki, Triumph,... (Switch may vary in visual appearance)



Opened switch type

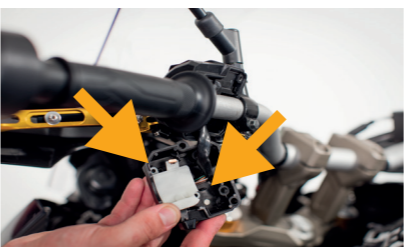

Covered switch type

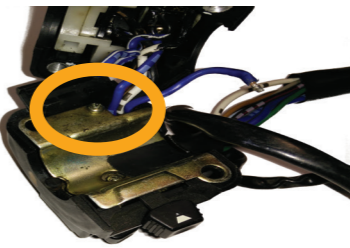

Insert smaller foams into switch mechanism cavities with tweezers.

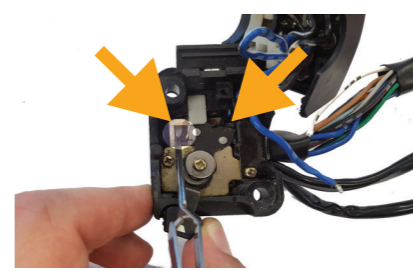

Reassemble switch with inserted foams back to handlebar.

Type 2:
 Scooters, Mopeds

Disassemble the switch from the handlebar.



Remove top plastic cover with a screwdriver.



Carefully extract the inside of the switch with tweezers.



Be careful not to lose the ball bearing and the spring.



Insert te spacer from the kit.



Reassemble the switch without the spring and the sphere inside.



Improper installation or operation of Smart Turn System
 Smart Turn System device has to be installed according to Movalyse installation manual. If you are not sure about any part of installation manual or/and your motorcycle wiring scheme please contact Movalyse d.o.o. at support@safer-turn.com

Warranty
 Limited Warranty applies to physical goods, and only for physical goods, purchased from Movalyse d.o.o. (the "Physical Goods"). Limited Warranty covers any defects in material or workmanship under normal use during the Warranty Period. During the Warranty Period, Movalyse d.o.o. will repair or replace, at no charge, products or parts of a product that proves defective because of improper material or workmanship, under normal use and maintenance. Movalyse d.o.o. will either repair the Product at no charge, using new or refurbished replacement parts. The Warranty Period for Physical Goods purchased from Movalyse d.o.o. is 365 days from the date that the product was shipped. A replacement Physical Good or part assumes the remaining warranty of the original Physical Good or 180 days from the date of replacement or repair, whichever is longer. This Limited Warranty does not cover any problem that is caused by: conditions; malfunctions or damage not resulting from defects in material or workmanship. To obtain warranty service, you must first contact our support@safer-turn.com to determine the problem and the most appropriate solution for you.

Movalyse d.o.o
 Vojkova cesta 63
 1000 Ljubljana
 Slovenia - EU
support@safer-turn.com