

Professional Weather Center

models 01036 / 01092



CONTENTS

Unpacking Instructions	2	PC Connect.....	13
Package Contents	2	Weather Underground	13
Product Registration	2	Using the Weather Center	14
Features & Benefits: 5-in-1	3	Weather Ticker	15
Features & Benefits: Display....	4	Programmable Alarms.....	16
Setup	7	Troubleshooting	18
5-in-1 Sensor Setup	7	Care & Maintenance.....	21
Display Setup	8	Calibration	21
Set the Time & Date	9	Specifications.....	23
Set Measurement Units.....	10	FCC Information	23
Set Language	10	Customer Support	24
Placement Guidelines	11	Warranty.....	24
5-in-1 Sensor Installation.....	12		

Questions? Contact Customer Support at
(844) 228-5465 or visit www.AcuRite.com.

SAVE THIS MANUAL FOR FUTURE REFERENCE.



Congratulations on your new AcuRite product. To ensure the best possible product performance, please read this manual in its entirety and retain it for future reference.

Unpacking Instructions

Remove the protective film that is applied to the LCD screen prior to using this product. Locate the tab and peel off to remove.

Package Contents

1. Display with Tabletop Stand
2. 5-in-1 Sensor
3. Sensor Mounting Bracket
4. Mounting Hardware
5. Power Adapter
6. USB Cable
7. Instruction Manual

IMPORTANT

PRODUCT MUST BE REGISTERED
TO RECEIVE WARRANTY SERVICE

PRODUCT REGISTRATION

Register online to receive 1 year warranty protection

www.AcuRite.com

Features & Benefits

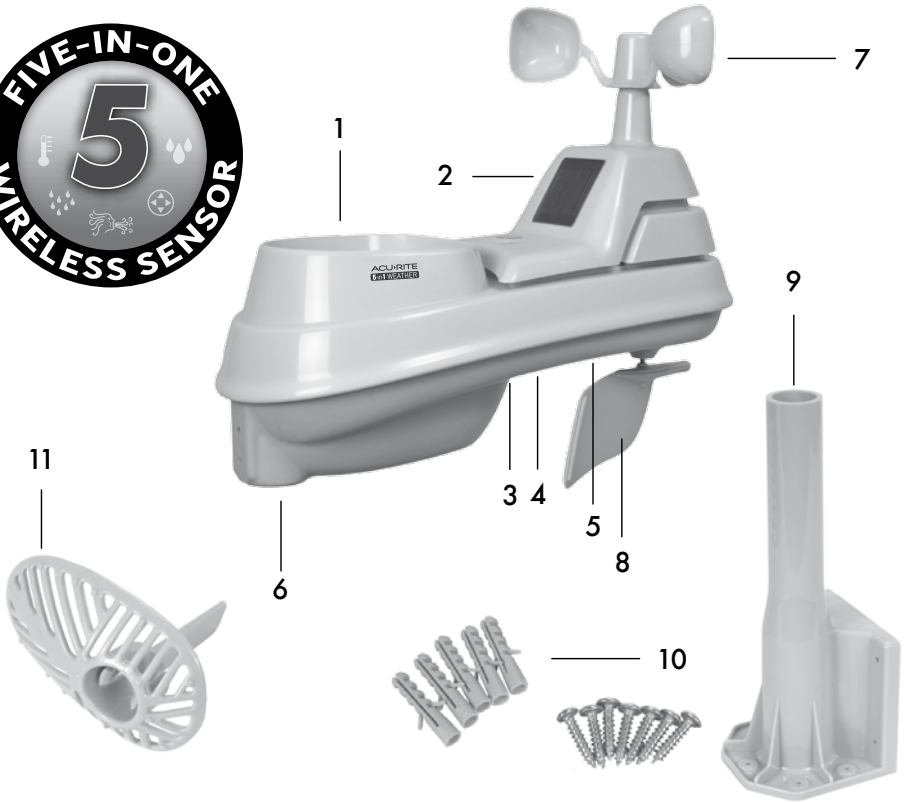

5-in-1 SENSOR

1. Rainfall Collector Funnel

2. Solar Cell Panel

Converts sunlight into power to run internal aspirating fan.

Internal Aspirating Fan

(not shown)

Draws ambient air into sensor to reduce solar radiation heating, resulting in more accurate temperature measurement.

3. A-B-C Switch

ID code that must match display's A-B-C switch to ensure units synchronize.

4. Battery Compartment

5. Temperature & Humidity Sensors (internal)

6. Mounting Point

7. Wind Speed Anemometer

8. Wind Direction Vane

9. Mounting Bracket

10. Mounting Hardware

Includes 5 anchors & the following screws:

Qty	Diameter	Length
5	#4	3/4"
1	#4	1/2"
1	#6	1/2"

11. Debris Filter

Pre-installed to prevent debris from entering the rain gauge.

Features & Benefits

Display

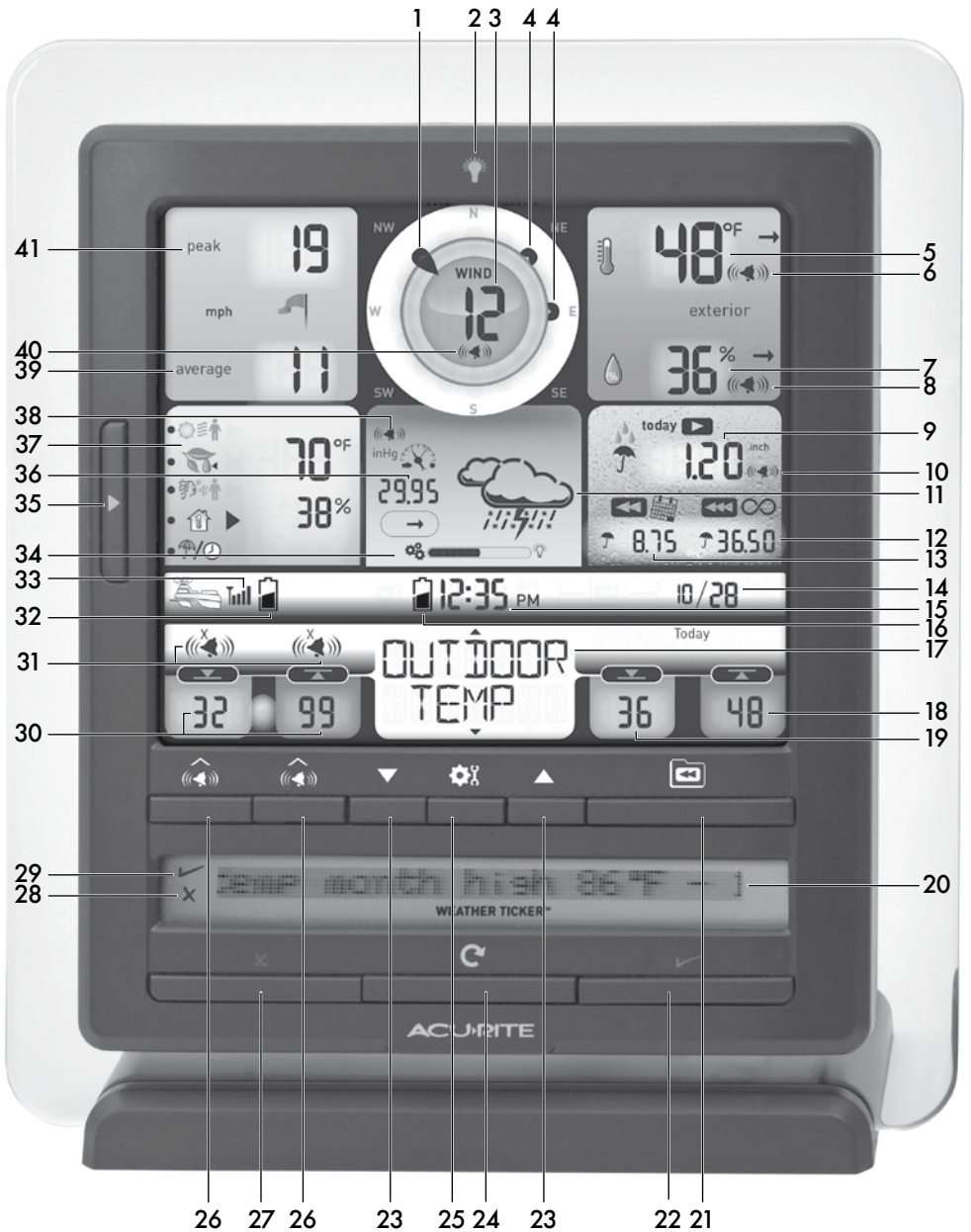

- 1. Current Wind Direction**
- 2. Touch Activated Backlight**
Momentary during battery power, always on/off for power adapter.
- 3. Current Wind Speed**
- 4. Previous 2 Wind Directions**
- 5. Current Outdoor Temperature**
Arrow icon indicates direction temperature is trending.
- 6. Outdoor Temperature Alarm On Indicator**
- 7. Current Outdoor Humidity**
Arrow icon indicates direction humidity is trending.
- 8. Outdoor Humidity Alarm On Indicator**
- 9. Current Rainfall**
Accumulates data during rainfall.
- 10. Rainfall Alarm On Indicator**
- 11. 12 to 24 Hour Weather Forecast**
Self-Calibrating Forecasting pulls data from your 5-in-1 sensor to generate your personal forecast.
- 12. All-Time Rainfall**
- 13. Current Month Total Rainfall**
- 14. Date**
- 15. Clock**
- 16. Display Low Battery Indicator**
- 17. Selectable Category**
- 18. Record High**
Shown for current category selected on the display (#17).
- 19. Record Low**
Shown for current category selected on the display (#17).
- 20. Weather Ticker™**
- 21.  Button**
Press for all-time low and date recorded for current category selected on display (#17). Press twice for all-time high and date recorded.
- 22.  Button**
Activates current Weather Ticker message during ticker customization mode.
- 23.  Buttons**
Press to select category (#17) adjust settings.
- 24.  Button**
Press to manually advance through Weather Ticker messages.
- 25.  Button**
For setup preferences.
- 26.  Button**
Activate alarm; press and hold to adjust alarm values.
- 27.  Button**
Deactivates current Weather Ticker message during ticker customization mode.
- 28. Indicates Deactivated Weather Ticker Message**
During ticker customization mode.
- 29. Indicates Active Weather Ticker Message**
During ticker customization mode.
- 30. Programmable Alarm Settings**
- 31. Alarm On/Off Indicator**
For Selectable Category (#17).
- 32. Sensor Low Battery Indicator**
- 33. 5-in-1 Sensor Signal Strength**
- 34. Learning Mode Icon**
Disappears after weather forecast self-calibration is complete.
- 35. Weather Select Button**
Press to change the Weather Select category data being displayed.
- 36. Current Barometric Pressure**
Arrow icon indicates direction pressure is trending.
- 37. Weather Select (top to bottom)**
Heat index, dew point, wind chill, indoor temperature / humidity, rainfall rate (in/mm per hour).
- 38. Storm Alert Alarm On Indicator**
- 39. Average Wind Speed**
of all speeds from past 2 minutes.
- 40. Wind Speed Alarm On Indicator**
- 41. Peak Wind Speed**
Highest speed from past 60 minutes.

Back of Display



BACK OF DISPLAY

- 1. Plug-in for Power Adapter**
- 2. Plug-in for USB Cable**
- 3. Integrated Hang Hole**
For easy wall mounting.
- 4. DEVICE ID**
12 digit unique ID required for online connectivity functions.
- 5. Backup Battery Compartment**
- 6. A-B-C Switch**
ID code that must match 5-in-1 sensor's A-B-C switch to ensure units synchronize.

- 7. CLEAR TODAY Button**
Clears data recorded since 12:00 am.
- 8. CLEAR ALL Button**
Clears all recorded data without having to reset time and date.
Note: USB mode will be reset to Mode 2 (Default).
- 9. RESET Button**
Full reset to factory defaults.
- 10. Power Adapter**
- 11. USB Cable for PC Connection**
- 12. Battery Compartment Cover**
(not shown)

5-in-1 Sensor Setup

1 Set the A-B-C Switch

Locate the A-B-C switch inside the battery compartment. Set the A-B-C switch to A, B or C. You must select the same letter choices for both the sensor and the display in order for the units to synchronize.

2 Install or Replace Batteries

Batteries **MUST** be installed for this product to operate. AcuRite recommends high quality alkaline or lithium batteries for the best product performance. Heavy duty or rechargeable batteries are not recommended.

The 5-in-1 sensor requires lithium batteries in low temperature conditions. Cold temperatures can

cause alkaline batteries to function improperly. Use lithium batteries in the 5-in-1 sensor for temperatures below -4°F / -20°C.

1. Slide off the battery compartment cover.
2. Insert 4 x AA batteries into the battery compartment, as shown. Follow the polarity (+/-) diagram in the battery compartment.
3. Replace the battery cover.

3 Remove Rain Gauge Stabilizer

Locate and remove the rain gauge stabilizer (plastic tab) taped into the bottom of the sensor. The rain gauge will not function until this is removed.

LITHIUM BATTERIES -40°F (-40°C) (70°C) 158°F

ALKALINE BATTERIES -4°F (-20°C) (70°C) 158°F

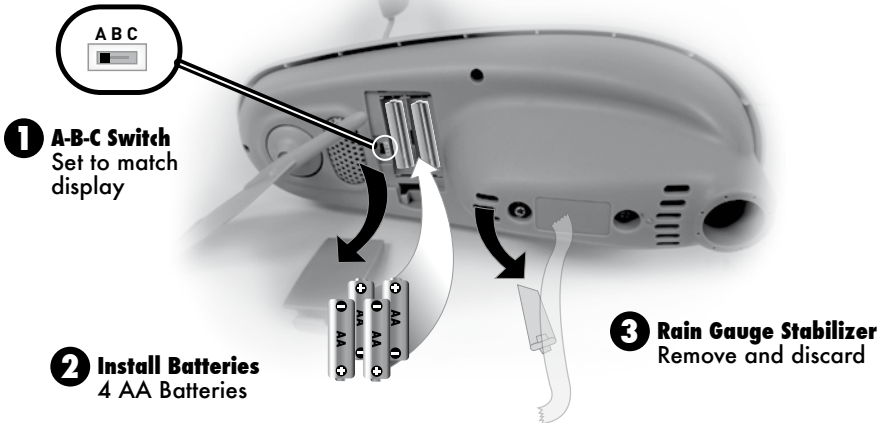

Display Setup

1 Set the A-B-C Switch

The A-B-C switch is located inside the battery compartment. It can be set to A, B or C. However, you must select the same letter choices for both the sensor and the display in order for the units to synchronize.

2 Plug Power Adapter into Electric Outlet

3 Write Down the DEVICE ID

12 digit unique ID needed for online connectivity functions.

24 C8 6E

4 Install or Replace Backup Batteries (optional)

Insert 6 x AA alkaline batteries into the battery compartment, as shown. Follow the polarity (+/-) diagram in the battery compartment.

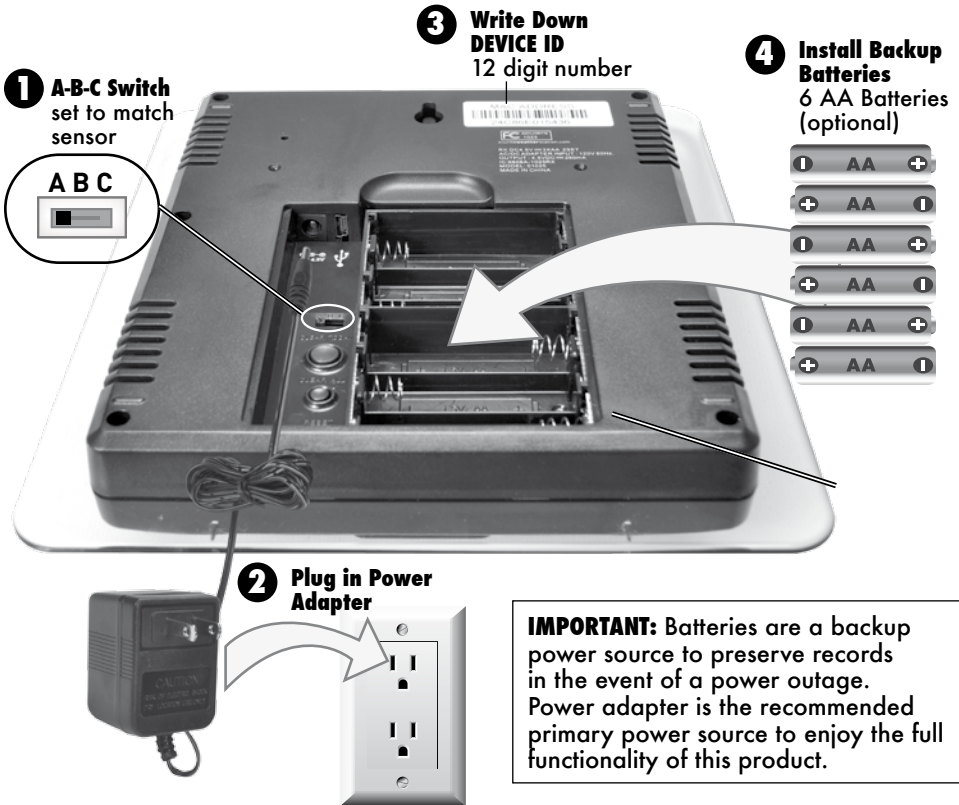

PLEASE DISPOSE OF OLD OR DEFECTIVE BATTERIES IN AN ENVIRONMENTALLY SAFE WAY AND IN ACCORDANCE WITH YOUR LOCAL LAWS AND REGULATIONS.

BATTERY SAFETY: Clean the battery contacts and also those of the device prior to battery installation. Remove batteries from equipment which is not to be used for an extended period of time. Follow the polarity (+/-) diagram in the battery compartment. Promptly remove dead batteries from the device. Dispose of used batteries properly. Only batteries of the same or equivalent type as recommended are to be used. DO NOT incinerate used batteries. DO NOT dispose of batteries in fire, as batteries may explode or leak. DO NOT mix old and new batteries or types of batteries (alkaline/standard). DO NOT use rechargeable batteries. DO NOT recharge non-rechargeable batteries. DO NOT short-circuit the supply terminals.

Set the Time & Date

The clock and calendar are utilized to time stamp history records and other data, so it is important to set the time and date soon after you power on the display.

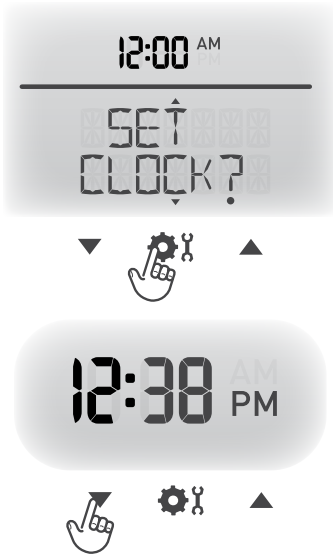

Note: The "?" stays in Selectable Categories, even after setup.



Set the Time

1. Press the "▲" or "▼" buttons until "SET CLOCK?" is displayed on the Selectable Category part of the display.
2. Press the "⚙️" button to set the clock.
3. Press the "▲" or "▼" buttons to adjust the hour. Note the "AM" and "PM" indicators.
4. Press the "⚙️" button to confirm hour selection.
5. Press the "▲" or "▼" buttons to adjust minutes.
6. Press the "⚙️" button to confirm minute selection.

The clock is now set.

Set the Date

1. Press the "▲" or "▼" buttons until "SET DATE?" is displayed on the Selectable Category part of the display.
2. Press the "⚙️" button to set the date.
3. Press the "▲" or "▼" buttons to adjust the month.
4. Press the "⚙️" button to confirm month selection.
5. Press the "▲" or "▼" buttons to adjust the day.
6. Press the "⚙️" button to confirm day selection.
7. Press the "▲" or "▼" buttons to adjust the year.
8. Press the "⚙️" button to confirm year selection.

The date is now set.

Select Measurement Units

To select between standard units (mph, °F, etc.) or metric units (kph, °C, etc.):

1. Press the "▲" or "▼" buttons until "SET UNITS?" is displayed on the Selectable Category part of the display.
2. Press the "⚙️" button to set the unit preference.
3. Press the "▲" or "▼" buttons to select "STAND" for standard or "METRIC" for metric units.
4. Press the "⚙️" button to confirm your selection.
5. Next, you will see "WIND MPH". Press the "▲" or "▼" buttons to select MPH, KPH, or KNOTS for wind speed units.
6. Press the "⚙️" button to confirm your selection.

Units are now set.



Set Language

To select between English (default) or French for the display language:

1. Press the "▲" or "▼" buttons until "SET LANG?" is displayed on the Selectable Category part of the display.
2. Press the "⚙️" button to set the language preference.
3. Press the "▲" or "▼" buttons to select the desired language.
4. Press the "⚙️" button to confirm your selection.

Language is now set.

Note: Display reverts to English language when display runs out of power or is reset.

Placement for Maximum Accuracy

AcuRite sensors are sensitive to surrounding environmental conditions. Proper placement of both the display and the sensor are critical to the accuracy and performance of this product.



Display Placement

Place the display in a dry area free of dirt and dust. To ensure accurate temperature measurement, place out of direct sunlight and away from heat sources or vents. Display stands upright for tabletop use or is wall-mountable.



5-in-1 Sensor Placement

The 5-in-1 sensor is designed to remain outdoors all year long. Choose an open location with no obstructions above or around the sensor for the most accurate measurements.

Important Placement Guidelines

Display and sensor must be within 330 feet (100 m) of each other.

MAXIMIZE WIRELESS RANGE

Place units away from large metallic items, thick walls, metal surfaces, or other objects that may limit wireless communication.

PREVENT WIRELESS INTERFERENCE

Place both units at least 3 feet (.9 m) away from electronic devices (TV, computer, microwave, radio, etc.).

LOCATE AWAY FROM HEAT SOURCES

Position sensor away from heaters, air conditioners, chimneys, exhaust vents, asphalt and concrete (surfaces that radiate heat).

LOCATE AWAY FROM HUMIDITY SOURCES

Avoid installing the sensor near pools, spas, or other bodies of water. Water sources may impact humidity accuracy.

LOCATE AWAY FROM SPRINKLER HEADS

DO NOT install the sensor where it will be sprayed by a sprinkler system. This may force water inside the sensor.

LOCATE AWAY FROM WIND & RAIN OBSTRUCTIONS

DO NOT mount the sensor with obstructions around it. Consider a location that is a wide open area, with few structures around to ensure accurate wind measurement.

Visit us online to view installation photos and video, or learn more about AcuRite technology:

www.AcuRite.com/5in1



View Video

5-in-1 Sensor Installation Guidelines

INSTALLATION HEIGHT Mount the sensor at least 5 feet (1.5 meters) off the ground in an open area. Higher is better for wind measurement- the National Weather Service recommends 33 feet (10 meters) high!

MOUNTING OPTIONS The included mounting bracket is designed to screw directly onto wooden posts or surfaces that are 2" x 4" or larger. The sensor can also be mounted directly to 3/4" steel pipe (available at hardware stores and home centers).

LEVEL INSTALLATION Use the bubble level on the top of the sensor to ensure level installation for accurate wind and rain measurement.

SOLAR CELL INSTALLATION Install the sensor with the **solar cell facing SOUTH**. This ensures the cell receives as much sun as possible and orients wind direction.

5-in-1 Sensor Installation

1. Fasten mounting base (included) to a post or pole (not included) using the 4 longer screws included in the hardware bag.
2. Insert the mounting base into the hole on the bottom of the sensor.
3. Make sure the arrows on the top of the sensor are pointed in the proper direction and the bubble level is centered. The solar cell should be facing south to properly orient the wind direction.
4. Fasten the sensor into the mounting base using the 2 shorter screws included in the hardware bag.

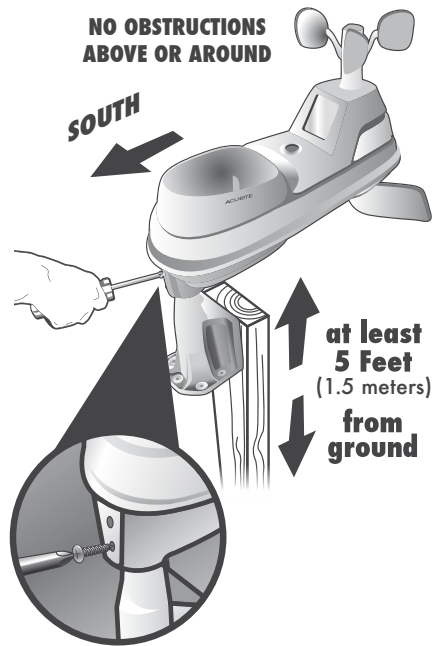

The 5-in-1 sensor is now ready to use.

Clear Data Collected During Installation

When installation is complete, clear erroneous data from the display by pressing the "CLEAR TODAY" button, on the back of the display inside the battery compartment. This button will clear data recorded since 12:00 am.

Basic Setup is Complete

The 5-in-1 sensor will now synchronize with the display. It may take a few minutes for synchronization to complete. If both or one of the units appear to be functioning improperly, please refer to the troubleshooting section.

PC Connect

PC Connect works with PCs to provide access to your Weather Center data in the following ways:

- **Data File:** The display logs (or stores) data so that you can download it to a CSV (comma separated values) data file on your PC.
- **Web Browser or Smartphone:** Monitor sensor data remotely using AcuRite's free AcuRite online software, or from a mobile device using the free AcuRite app, available from the Apple App Store or Google Play Store.
- **Weather Underground:** This weather station is compatible for streaming data to the Weather Underground Personal Weather Station Network. For more information, navigate to: www.acurite.com > Support > Downloads

USB Mode

To set up PC Connect, you must first select mode 3 on your display to gain access to all functionality. Modes 1, 2 and 4 are not used for the PC Connect software.

1. Press the "▲" or "▼" buttons until "SET USB MODE?" is displayed on the Selectable Category part of the display.
2. Press the "⚙️" button to set the mode preference.
3. Press the "▲" or "▼" buttons to select USB mode #3.
4. Press the "⚙️" button to confirm your selection. PC Connect USB Mode is now set.

Download the Software

The PC Connect software is available online as a free download. A manual (PDF) is included with the software download.

Before setting up the PC Connect software, verify that the display is ON with the power adapter plugged in. Next, connect the mini-USB (small end of the cable) into the USB port on the display, located inside the battery compartment.



- 1 Download PC Connect software to your computer by visiting: www.acurite.com > Support > Downloads
- 2 Open the file that was downloaded in step 1 and follow the on-screen instructions to install the software.
- 3 After PC Connect is installed on the computer, the initial configuration will begin automatically. Select where to save weather data downloaded from the display. By default, this will create a folder on the computer.
- 4 When prompted by the software to plug in the display, connect the USB (larger end of the cable) into a USB port on the computer.

PC Connect is installed and ready for use.

Follow the instructions within the PC Connect app to complete setup and begin using the software.









Using the Professional Weather Center

Learning Mode

Self-Calibrating Forecasting use a unique algorithm to analyze changes in pressure over a time period (called Learning Mode) to determine your altitude. After 14 days, the Learning Mode icon disappears from the display screen. At this point, the self-calibrated pressure is tuned in to your location and the unit is ready for superior weather prediction.

Weather Forecast





AcuRite's patented Self-Calibrating Forecasting provides your personal forecast of weather conditions for the next 12 to 24 hours by collecting data from the sensor in your backyard. It generates a forecast with pinpoint accuracy - personalized for your exact location.

STORM LIKELY 	PARTLY CLOUDY 	CLOUDY 	RAIN LIKELY 	SNOW LIKELY 	CHANCE OF MIXED RAIN & SNOW 
---	---	--	---	---	---

View the complete list of icons at www.AcuRite.com/acurite-icons

Weather Select

Features weather data groups shown at right. To change "Weather Select" category, press the selection arrow button just to the left of the weather select display area.

	= Heat Index
	= Dew Point
	= Wind Chill
	= Indoor Conditions
	= Rainfall Rate (in./hour)

Rainfall Event

The rainfall feature tracks rain accumulation over all-time, the current month, and current rainfall event. Current event clears when no rain registers for 8 hours OR no rain registers for 1 hour and pressure rises by .03inhg or more.

Barometric Pressure

Subtle variations in barometric pressure greatly affect the weather. This weather center displays the current current pressure with an arrow icon to indicate the direction the pressure is trending (FALLING, STEADY, or RISING).

Weather Ticker™

The Weather Ticker™ automatically streams your real-time weather information and alerts as scrolling text in the lower part of the display screen.

You can manually cycle through all the available messages by pressing “” button.

Default WEATHER TICKER messages are pre-loaded as follows:

FORECAST	12 to 24 hour future weather forecast
MOON PHASE	Current moon phase
INDOOR COMFORT	Dry, OK or humid comfort level
IT FEELS LIKE __ OUTSIDE	Calculates what temperature it feels like outdoors (based on temperature, humidity and wind speed)
OUTDOOR TEMP THIS WEEK HIGH	Highest temperature recorded this calendar week
OUTDOOR TEMP THIS WEEK LOW	Lowest temperature recorded this calendar week
OUTDOOR TEMP THIS MONTH HIGH	Highest temperature recorded this calendar month
OUTDOOR TEMP THIS MONTH LOW	Lowest temperature recorded this calendar month

Additional Messages Include:

NEW HIGH TEMPERATURE RECORD

NEW LOW TEMPERATURE RECORD

NEW WIND SPEED RECORD TODAY

CURRENT RAINFALL RATE

CURRENT RAIN EVENT STARTED



NO RAIN RECORDED SINCE _____

WEATHER ALARM MESSAGES

SENSOR BATTERIES LOW

SENSOR SIGNAL LOST

Adjust the Weather Ticker Speed

1. Press the “▲” or “▼” buttons until “TICKER SPEED” is displayed on the Selectable Category part of the display.
2. Press the “” button to set the speed preference.
3. Press the “▲” or “▼” buttons to select a speed: SLOW, NORMAL, or FAST.
4. Press the “” button to confirm your selection.

Weather Ticker speed is now set.

Customize Weather Ticker Messages

Customize which messages you want to scroll across the WEATHER TICKER:

1. Press the "↻" button to manually cycle through each message available.
2. During the MANUAL REVIEW: PRESS the "✓" button to activate the current scrolling message. The corresponding "✓" appears on screen to the left of the message to indicate the message is now active in the ticker cycle. PRESS the "X" button to deactivate the current scrolling message. The corresponding "X" appears on screen to the left of the message to indicate the message is now deactivated from the ticker cycle.

Please note: Messages can only be added and removed to the ticker cycle during manual review. The "✓" and "X" buttons do not add or remove messages during the automatic cycle.

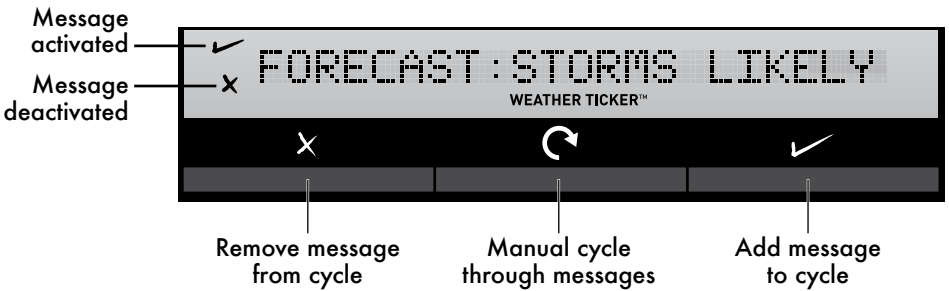

Programmable Weather Alarms

Each Selectable Weather Category features an alarm option. When an alarm sounds, the display emits audible beeping and flashes the affected category, its alarm settings, and any other relevant data.

Some alarms can be customized to alert you when your programmed value is reached. Alarms include:

OUTDOOR HUMIDITY	LOW	HIGH
OUTDOOR TEMP	LOW	HIGH
STORM ALARM	HIGH	
INDOOR HUMIDITY	LOW	HIGH
INDOOR TEMP	LOW	HIGH
WIND CHILL	LOW	
DEW POINT	LOW	HIGH
HEAT INDEX	HIGH	
RAIN	HIGH	
WIND SPEED	HIGH	

The rain alarm does not require a preset numerical value, but instead sounds as soon as rain is recorded. Similarly, the storm alarm sounds when a large atmospheric pressure drop occurs, which usually indicates an oncoming storm. Note: The storm alarm is NOT intended to be a safety device or warning system.

Set a Weather Alarm

1. Choose the weather category for which you wish to set an alarm by pressing the "▲" or "▼" buttons until the category is displayed on the Selectable Category part of the display.
2. To program a value (only applies to alarms that require a value), press AND HOLD the "((☞))" button underneath the alarm you wish to set until the "⚙️" indicator appears and the alarm setting flashes.
3. Adjust the alarm value by pressing the "▲" or "▼" buttons.
4. Press the "((☞))" button to confirm a value.
5. Next, press the "((☞))" button to activate the alarm (the X indicator disappears when alarm is activated).

Alarm is now programmed and turned on.

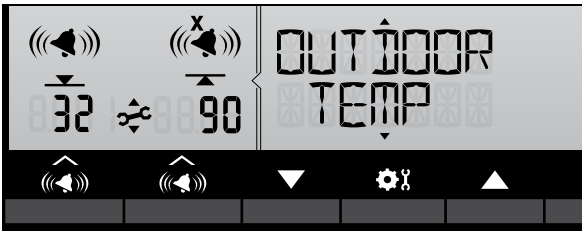

ICON DEFINITIONS

- = Alarm On
- = Alarm Off
- = Adjust Mode
- = Low Value
- = High Value

BUTTON FUNCTIONS

- Press to activate or deactivate an alarm.
- Press and hold to set or adjust an alarm value.

Silence a Sounding Alarm

The alarm sounds initially for a few minutes, then silences itself. The alarm then sounds every few minutes afterwards until one of the following happens:

1. "SNOOZE" - Press any button. Alarm silences, but sounds again if the alarm condition reoccurs.
2. Turn alarm "OFF" - Deactivates alarm.

Troubleshooting

Problem	Possible Solution
<p>No outdoor sensor reception</p>  no bars	<ul style="list-style-type: none"> • Relocate the display and/or the 5-in-1 sensor. The units must be within 330 ft (100 m) of each other. • Make sure both units are placed at least 3 feet (.9 m) away from electronics that may interfere with the wireless communication (such as TVs, microwaves, computers, etc). • Use standard alkaline batteries (or lithium batteries in sensor when temperature is below -4°F/-20°C). Do not use heavy duty or rechargeable batteries. NOTE: It may take a few minutes for display and sensor to synchronize after batteries are replaced. • Synchronize the units: <ol style="list-style-type: none"> 1. Bring both the sensor and display indoors and remove power adapter/batteries from each. 2. Reinstall batteries in outdoor sensor. 3. Reinstall power adapter/batteries in display. 4. Let the units sit within a couple feet of each other for a few minutes to gain a strong connection.
<p>Outdoor temperature is flashing or showing dashes</p>	<p>Flashing of the outdoor temperature may be an indication of wireless interference.</p> <ul style="list-style-type: none"> • Make sure the A-B-C switch in the battery compartments of both the display and sensor are switched to the same letter. You may choose A, B or C; but both units must match to sync up. Sometimes changing to a different channel can help.
<p>Weather Ticker Hard to Read</p>	<ul style="list-style-type: none"> • Slow down the speed of the ticker (see page 15).
<p>Inaccurate forecast</p>	<ul style="list-style-type: none"> • Weather Forecast icon predicts conditions for the next 12 to 24 hours, not current conditions. • Has Learning Mode icon disappeared from the display? Learning Mode must complete before forecast and pressure will be accurate. • Allow unit to run continuously for 33 days. Battery removal or resetting the display will restart Learning Mode. After 14 days, forecast should be fairly accurate, however Learning Mode calibrates for a total of 33 days.

Troubleshooting

Problem	Possible Solution
<p>Inaccurate temperature or humidity</p>	<ul style="list-style-type: none"> • Make sure both the display and 5-in-1 sensor are placed away from any heat sources or vents (see page 11). • Make sure both units are positioned away from moisture sources (see page 11). • Make sure 5-in-1 sensor is mounted at least 5 ft off of the ground. • Calibrate indoor and outdoor temperature and humidity (see page 21).
<p>No rainfall</p>	<ul style="list-style-type: none"> • Check to ensure the rain gauge stabilizer (plastic tab) has been removed from the bottom of the sensor (see page 7). • Clear debris, such as leaves, out of the rain collector funnel and debris screen. • Calibrate the Rain Gauge (see page 22).
<p>Inaccurate wind readings</p>	<ul style="list-style-type: none"> • What is wind reading being compared to? Pro weather stations are typically mounted at 30 ft high or more. Make sure to compare data using a sensor positioned at the same mounting height. • Check location of the sensor. Ensure it's mounted a minimum of 5 ft in the air with no obstructions around it (within several feet). • Ensure wind cups are spinning freely. If they hesitate or stop try lubricating with graphite powder or spray lubricant.
<p>USB connectivity not working</p>	<ul style="list-style-type: none"> • Verify display is in USB mode 3 (see page 13). • Unplug USB from display to computer for 20 seconds, and then plug back in. • Check that the batteries are installed correctly. Batteries may need to be replaced. • Reset the display by pressing the reset button, located on the back of the display. Date and time will need to be entered after a reset.
<p>Display screen not working</p>	<ul style="list-style-type: none"> • Check that the batteries are installed correctly. Batteries may need to be replaced. • Reset the display by pressing the reset button, located on the back of the display. Date and time will need to be entered after a reset.

Troubleshooting

Problem	Possible Solution
Cannot access data online or on the AcuRite mobile app	<ul style="list-style-type: none">• Verify under Status that data was received from the indoor display. The timestamp should update every 18-36 seconds.• Verify that you created an account or logged into an existing account at www.MyAcuRite.com or in the AcuRite app, and that you input the display's DEVICE ID as a part of the account setup.• Verify the PC that the display is connected to is always powered ON.• Verify the PC that the display is connected to is always connected to the internet.• Verify that the display's DEVICE ID is entered correctly in the PC Connect software on your PC.• Verify that "Sharing" is enabled in the PC Connect software on your PC.• Verify that the display's DEVICE ID is correct in your www.MyAcuRite.com and/or AcuRite mobile app account.• Follow on-screen troubleshooting steps in the PC Connect software.
No data received from indoor display	<ul style="list-style-type: none">• Verify that the USB cable is securely connected to the display AND to the PC.• Verify the display is powered ON.• Restart the PC Connect software.• Unplug the USB cable from the PC for 1 minute, then plug the cable back in again.• USB port may be malfunctioning, try using a different USB port.

If your AcuRite product does not operate properly after trying the troubleshooting steps, visit www.AcuRite.com or call (844) 228-5465 for assistance.

Care & Maintenance

Display Care

Clean with a soft, damp cloth. Do not use caustic cleaners or abrasives. Keep away from dust, dirt and moisture. Clean ventilation ports regularly with a gentle puff of air.

5-in-1 Sensor Care

Clean the Sensor

Clean with a soft damp cloth. Do not use caustic cleaners or abrasives that will mar the polished surfaces of the rain collection funnel or the solar cell. Scratches will result in decreased performance and reliability.

Insect Prevention

Insects may cause obstructions and interrupt data by nesting in or on the 5-in-1 sensor. To limit this problem, spray sensor with a household insect repellent. Consult the insect repellent instructions prior to use.

Snow & Freezing Weather

The 5-in-1 sensor will not be damaged by freezing conditions. NOTE: If the rain collector cup fills with snow and then melts, it will register as rain on the display.

Clean the Rain Collector Cup

Remove and empty rain collector debris filter. The debris filter is located in the rain collector funnel. Remove from the top by gently squeezing and pulling out.

Clean the Wind Vane & Anemometer

Remove foreign matter from the outside of the sensor for free movement of the wind vane and anemometer. If needed, use a small amount of spray lubricant, clear silicone or graphite powder on the anemometer for improved movement.

Calibration

Calibrate Temperature & Humidity

The indoor / outdoor temperature and humidity readings can be calibrated on the display to improve accuracy. Calibration improves accuracy when 5-in-1 sensor placement or environmental factors impact your data accuracy.

1. Choose the weather category you wish to calibrate by pressing the "▲" or "▼" buttons until the category is displayed on the Selectable Category part of the display.
2. Press AND HOLD the "▲", "▼" and "⚙️" buttons all at the same time for 10-15 seconds.
 - The display beeps, and all display data is hidden except for the value being calibrated.
 - "⚙️" (calibrate) and arrows appear next to the value being calibrated.

3. Press the "▲" or "▼" buttons to calibrate the data value higher or lower from the actual reading.
4. Press the "⚙️" button to confirm the calibration adjustment.
Note: The "⚙️" icon remains illuminated next to calibrated values.



Calibrate the Rain Gauge

The rain gauge on the 5-in-1 sensor can be calibrated to improve accuracy.

Items Needed: 5-in-1 sensor, display, plastic cup, pin, screw driver

1. First, ensure 5-in-1 sensor is perfectly level using built-in bubble level.
2. Place display close so you can monitor it during calibration.
3. Make a pin hole in the bottom of a plastic cup. Hold the cup over the rain gauge and fill it with exactly 1 cup (8oz) of water, allowing the water to drip into the rain gauge. You should hear the internal buckets tip and see water drain through the rain gauge.
4. A few seconds after each bucket tip, the display displays rainfall in approximately 0.01" or more increments.
5. The cup of water should take more than 20 minutes to empty; a quicker period will result in inaccurate calibration. Try to simulate a normal steady rainfall. When cup is empty of water, display should register 1.06"

Tips

- There should be nearly an equal number of water drops (about 25 water drops) between bucket tips. If not, adjust the calibration screws on the bottom of the 5-in-1 sensor until an equal number of water drops are tipping the buckets. Then, restart the calibration procedure.
- If you don't hear the buckets tipping and see water dripping alternately out of each drain, there may be an issue with the rain gauge or it's adjustment. See Troubleshooting on page 21.

Adjustment

If the rain gauge doesn't register close to 1.06", make an EQUAL adjustment to the two calibration screws on the bottom of the 5-in-1 sensor. Turning screws clockwise increases rainfall; counter clockwise decreases rainfall.

- To adjust the rainfall reading by 2% turn both screws 1/8 of a turn.
- To adjust the rainfall reading by 4% turn both screws 1/4 of a turn.
- To adjust the rainfall reading by 8% turn both screws 1/2 of a turn.

Watch the video at www.acurite.com/5in1

Specifications

TEMPERATURE RANGE	Outdoor: -40°F to 158°F; -40°C to 70°C
	Indoor: 32°F to 122°F; 0°C to 50°C
HUMIDITY RANGE	Outdoor: 1% to 99%
	Indoor: 16% to 98%
WIND SPEED	0 to 99 mph; 0 to 159 kph
WIND DIRECTION INDICATORS	16 points
RAINFALL	0.01 inches (0.25 mm) and up
WIRELESS RANGE	330ft / 100m depending on home construction materials
OPERATING FREQUENCY	433 MHz
POWER	Display: 5V, 250mA adapter 6 x AA alkaline batteries (optional)
	Sensor: 4 x AA alkaline or lithium batteries
DATA REPORTING	Wind Speed: 18 second updates; Direction: 30 seconds Outdoor temperature & humidity: 36 second updates Indoor temperature & humidity: 60 second updates PC Connect CSV Data Logging: 12 minute intervals PC Connect to Online Portal/App: 18 seconds
DISPLAY MEMORY	512 kilobytes (not expandable)
PC CONNECT SYSTEM REQUIREMENTS	Mac OS X 10.9 (Mavericks) or higher
	Windows 8.1 / 8 / 7; 1 GHz or faster processor; 1 GB (32-bit) or 2 GB (64-bit) of RAM; available USB port
	High speed internet is required for some advanced features of PC Connect, such as Weather Underground Rapid Fire Updates.

FCC Information

This device complies with part 15 of FCC rules. Operation is subject to the following two conditions:

1- This device may NOT cause harmful interference, and

2- This device must accept any interference received, including interference that may cause undesired operation.

This equipment has been tested and found to comply with the limits for a Class B digital device, pursuant to Part 15 of the FCC rules. These limits are designed to provide reasonable protection against harmful interference in a residential installation. This equipment generates, uses and can radiate radio frequency energy and, if not installed and used in accordance with the instructions, may cause harmful interference to radio communications. However, there is no guarantee that interference will not occur in a particular installation. If this equipment does cause harmful interference to radio or television reception, which can be determined by turning the equipment off and on, the user is encouraged to try to correct the interference by one or more of the following measures:

- Reorient or relocate the receiving antenna.
- Increase the separation between the equipment and the receiver.
- Connect the equipment into an outlet on a circuit different from that to which the receiver is connected.
- Consult the dealer or an experienced radio/TV technician for help.

NOTE: The manufacturer is not responsible for any radio or TV interference caused by unauthorized modifications to this equipment. Such modifications could void the user authority to operate the equipment.

This device complies with Industry Canada licence-exempt RSS standard[s].

Operation is subject to the following two conditions:

[1] This device may not cause interference, and

[2] This device must accept any interference received, including interference that may cause undesired operation of the device.

Customer Support

AcuRite customer support is committed to providing you with best-in-class service. **For assistance**, please have the model number of this product available and contact us in any of the following ways:



(844) 228-5465

Visit us at www.AcuRite.com

- ▶ Installation Videos
- ▶ Register your Product
- ▶ Instruction Manuals
- ▶ Support User Forum
- ▶ Replacement Parts
- ▶ Submit Feedback & Ideas

IMPORTANT

PRODUCT MUST BE REGISTERED
TO RECEIVE WARRANTY SERVICE

PRODUCT REGISTRATION

Register online to receive 1 year warranty protection

www.AcuRite.com

Limited 1 Year Warranty

AcuRite is a wholly owned subsidiary of Chaney Instrument Company. For purchases of AcuRite products, AcuRite provides the benefits and services set forth herein. For purchases of Chaney products, Chaney provides the benefits and services set forth herein.

We warrant that all products we manufacture under this warranty are of good material and workmanship and, when properly installed and operated, will be free of defects for a period of one year from the date of purchase.

Any product which, under normal use and service, is proven to breach the warranty contained herein within ONE YEAR from date of sale will, upon examination by us, and at our sole option, be repaired or replaced by us. Transportation costs and charges for returned goods shall be paid for by the purchaser. We hereby disclaim all responsibility for such transportation costs and charges. This warranty will not be breached, and we will give no credit for products which have received normal wear and tear not affecting the functionality of the product, been damaged (including by acts of nature), tampered, abused, improperly installed, or repaired or altered by others than our authorized representatives.

Remedy for breach of this warranty is limited to repair or replacement of the defective item(s). If we determine that repair or replacement is not feasible, we may, at our option, refund the amount of the original purchase price

THE ABOVE-DESCRIBED WARRANTY IS THE SOLE WARRANTY FOR THE PRODUCTS AND IS EXPRESSLY IN LIEU OF ALL OTHER WARRANTIES, EXPRESS OR IMPLIED. ALL OTHER WARRANTIES OTHER THAN THE EXPRESS WARRANTY SET FORTH HEREIN ARE HEREBY EXPRESSLY DISCLAIMED, INCLUDING WITHOUT LIMITATION THE IMPLIED WARRANTY OF MERCHANTABILITY AND THE IMPLIED WARRANTY OF FITNESS FOR A PARTICULAR PURPOSE.

We expressly disclaim all liability for special, consequential, or incidental damages, whether arising in tort or by contract from any breach of this warranty. Some states do not allow the exclusion or limitation of incidental or consequential damages, so the above limitation or exclusion may not apply to you.

We further disclaim liability from personal injury relating to its products to the extent permitted by law. By acceptance of any of our products, the purchaser assumes all liability for the consequences arising from their use or misuse. No person, firm or corporation is authorized to bind us to any other obligation or liability in connection with the sale of our products. Furthermore, no person, firm or corporation is authorized to modify or waive the terms of this warranty unless done in writing and signed by a duly authorized agent of ours.

In no case shall our liability for any claim relating to our products, your purchase or your use thereof, exceed the original purchase price paid for the product.

Applicability of Policy

This Return, Refund, and Warranty Policy applies only to purchases made in the United States and Canada. For purchases made in a country other than the United States or Canada, please consult the policies applicable to the country in which you made your purchase.

Additionally, this Policy applies only to the original purchaser of our products. We do not and do not offer any return, refund, or warranty services if you buy products used or from resale sites such as eBay or Craigslist.

Governing Law

This Return, Refund, and Warranty Policy is governed by the laws of the United States and the State of Wisconsin. Any dispute relating to this Policy shall be brought exclusively in the federal or State courts having jurisdiction in Walworth County, Wisconsin; and purchaser consents to jurisdiction within the State of Wisconsin.

ACU RITE®



Weather
Stations



Temperature
& Humidity



Weather
Alert Radio



Kitchen
Thermometers
& Timers



Clocks

It's More than Accurate, it's ACU RITE.

AcuRite offers an extensive assortment of precision instruments, designed to provide you with information you can depend on to Plan your day with confidence™.

www.AcuRite.com

©Chaney Instrument Co. All rights reserved. AcuRite is a registered trademark of the Chaney Instrument Co., Lake Geneva, WI 53147. All other trademarks and copyrights are the property of their respective owners. AcuRite uses patented technology. Visit www.AcuRite.com/patents for details.