

GN350A

CURVED GAMING MONITOR

USER MANUAL



Table of Contents

- Section 1: Safety Precautions.....4**
- Section 2: Box Contents.....5**
- Section 3: Product Overview6**
 - 3.1 – Monitor Buttons6
 - 3.2 – Monitor Ports.....6
- Section 4: Stand Installation.....7**
- Section 5: Wall Mounting.....8**
- Section 6: Connectivity Options9**
 - 6.1 – Connecting the Power Cable.....9
 - 6.2 – Connecting Headphones9
 - 6.3 – DP Connectivity.....10
 - 6.4 – HDMI Connectivity10
 - 6.5 – DVI Connectivity.....10
- Section 7: Basic Operation11**
- Section 8: Indicator Light11**
- Section 9: OSD12**
 - 9.1 – OSD Menu Functions13
- Section 10: ECO Modes and Gameplus Switching.....14**
- Section 11: Troubleshooting15**
 - 11.1 – General Problems15
 - 11.2 – PIP (Picture in Picture) Input Information16
 - 11.3 – PBP (Picture by Picture) Resolution Information16
- Section 12: Information17**
 - 12.1 – Specifications17
 - 12.2 – Resolution Compatibility for DVI/DP17
- Section 13: 1 Year Limited Hardware Warranty17**

Section 1: Safety Precautions

Read and observe the following warnings and information below.

1. Before cleaning, always unplug your monitor. It is recommended that you use dry cloth or lightly damp cloth to clean your monitor. Dry cloth is, however, the safest. If using damp cloth, wait for your monitor to completely dry before plugging it in again.
2. Do not use alcohol or ammonia-based cleaner and/or liquids to clean your monitor.
3. This monitor features ventilation openings on the back of the unit. Avoid blocking these openings to prevent the monitor from overheating.
4. Avoid placing this monitor near any heat sources, e.g., portable heaters or heating vents, as this may cause damage to your monitor.
5. Do not spray cleaner and or any kind of liquid directly onto the monitor's screen or any part of the monitor.
6. Do not insert anything into ventilation openings.
7. Always make sure your monitor is placed on a secure, level surface to prevent it from falling and sustaining damage.
8. Unplug the monitor during extended periods of non-use.
9. Do not place heavy items on the monitor or monitor cables.
10. Do not attempt to disassemble or remove parts from the monitor. Any disassembly or modification not performed by an authorized technician can result in damage to the monitor and/or possible exposure to high-voltage electricity, which may lead to serious injury or death.

VIOTEK shall not be held responsible for injury or damage of products or persons due to failure to adhere to the aforementioned precautions or any others noted hereafter.

Section 2: Box Contents



Monitor x 1



Stand Stem x 1

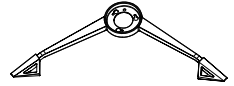

Stand Base x 1



NO. 1 Screw x 1



NO. 2 Screws x 2



NO. 3 Screws x 4



User Manual x 1



Power Cable x 1
(AC 100-240V, 50/60Hz)

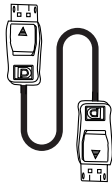

DP Cable x 1



Screwdriver x 1



Cable Clip x 1

Section 3: Product Overview

3.1 – Monitor Buttons

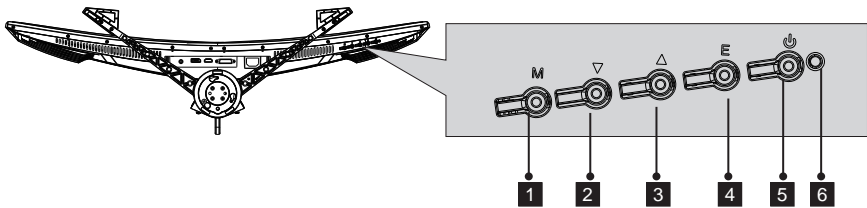

- 1** M Menu Button: Press to display the OSD menu or enter sub-menus.
- 2** ▼ Down Button: Press to move down in the menus.
- 3** ▲ Up Button: Press to move up in the menus.
- 4** E Exit Button: Press to exit.
- 5** ⏻ Power Button: Press to turn the monitor on/off.
- 6** LED Indicator: Changes colors to indicate status. Refer to Section 8.



The E button can also be used to switch between “Limit” and “Full” color gamuts when a compatible graphics card and either HDMI or DP connections are in use.

3.2 – Monitor Ports

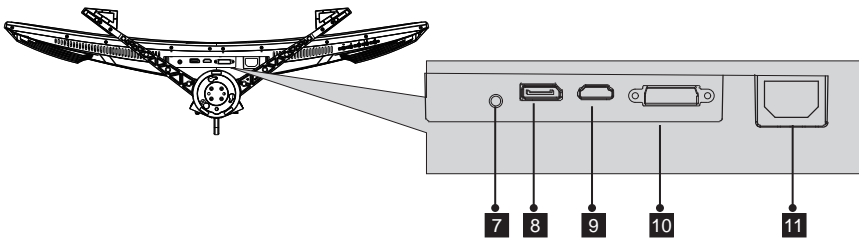

- 7** Audio Output: Insert the audio cable for output of audio signals.
- 8** DP Connector: Insert one end of the DP cable into the computer's DP output and connect the other end to the monitor's DP port.
- 9** HDMI Connector: Insert one end of the HDMI cable into the computer's HDMI output and connect the other end to the monitor's HDMI port.
- 10** DVI Connector: Insert one end of the DVI cable into the computer's DVI output and connect the other end to the monitor's DVI port.
- 11** Power Connector: Insert the Power Cable to supply power to the monitor.

Section 4: Stand Installation



Keep the foam underneath the monitor before attaching the stand.

1. Open the package and take out the product with foam still attached. Gently place it on a desktop or table.
2. Take out the cable clip, stand stem and stand base. Remove the foam covering the bottom of the monitor. Slide the cable clip down on the back of the stand stem to attach it to the stand stem. Use the NO. 1 screw to fasten the Stand Base to the Stand Stem.

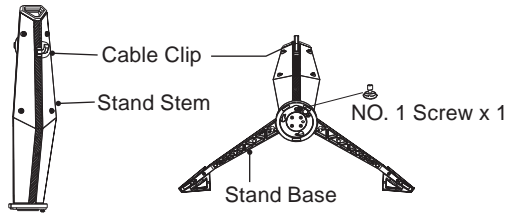

3. Press the button to remove the stand plate, and use two NO. 2 screws to install the it onto the stand stem.

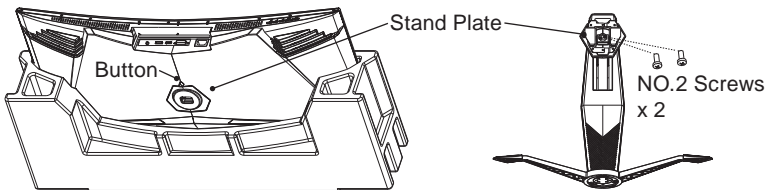

4. Insert the stand's plate into the opening on the back of the monitor. It should click into place. Make sure the stand is securely attached to the back of the monitor before removing the monitor from the remaining foam and stand it up on a secured, level table or desk.



The stand can easily be detached from the monitor by pressing the button near the stand plate. Make sure the monitor is laid on a flat surface before removing the stem.

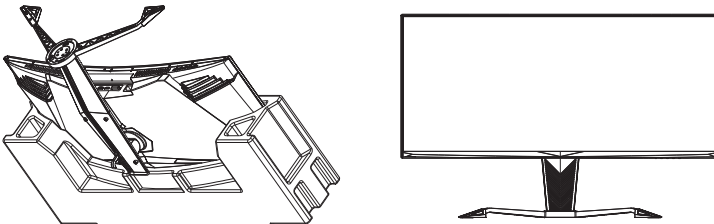

Section 5: Wall Mounting



This monitor ONLY includes screws which can be used for attaching the monitor to a mount. No mount or mounting accessory is included.

1. Open the package and take out the product with foam still attached. Gently place it on a desktop or table. Remove the extra parts and the foam covering the monitor. If the monitor is already attached to the stand, remove the stand.
2. Remove the original screws (1), from the opening in the back of the monitor. Then use the NO. 3 screws to attach the adapters inside the opening.



- Do not discard the original screws.
- Use only the NO. 3 screws x 4 (2) provided. You MUST follow the instructions below for secure installation.

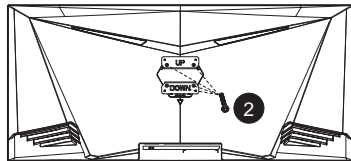
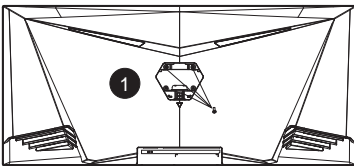

3. Follow the directions received with your mount, stand or accessory. Install the monitor on the wall or fixture as desired.

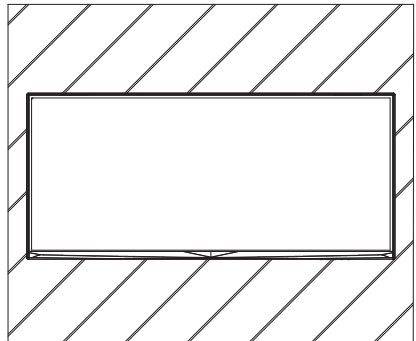
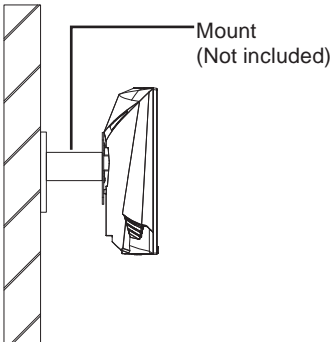

Section 6: Connectivity Options

6.1 – Connecting the Power Cable

Connect the included power cable to the power connector, and then plug the other end into an wall outlet.

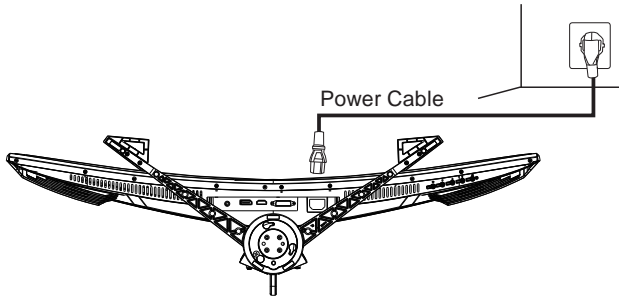

6.2 – Connecting Headphones

Plug in your headphones, or any 3.5mm-compatible external audio device, to receive audio signals from your monitor. If your headphones are connected to the monitor while audio devices are connected to your computer, the audio devices will not produce sound. Headphones and other audio devices not included.

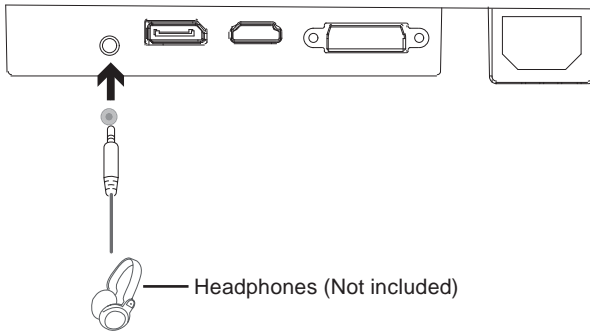

Listening to loud audio for prolonged periods of time may permanently damage your hearing.

6.3 – DP Connectivity

In order for the monitor to receive DP signals from the computer, use the DP cable to connect the monitor to the computer.

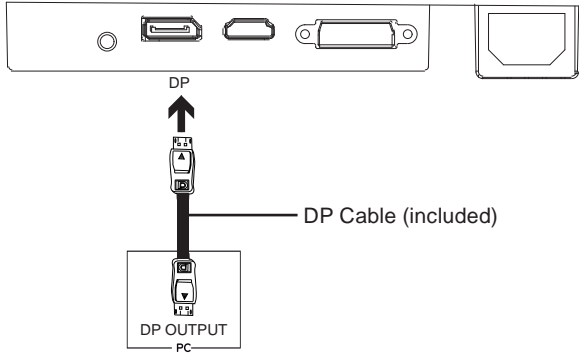

6.4 – HDMI Connectivity

In order for the monitor to receive HDMI signals from the computer, use an HDMI cable to connect the monitor to the computer.

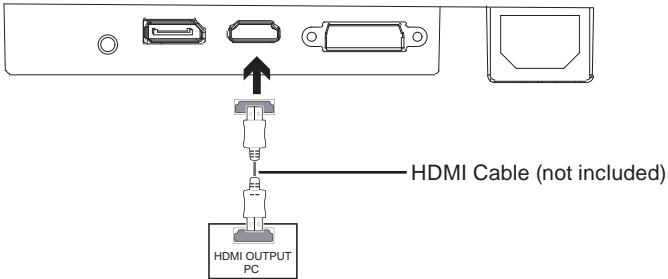

6.5 – DVI Connectivity

In order for the monitor to receive DVI signals from the computer, use a DVI cable to connect the monitor to the computer.

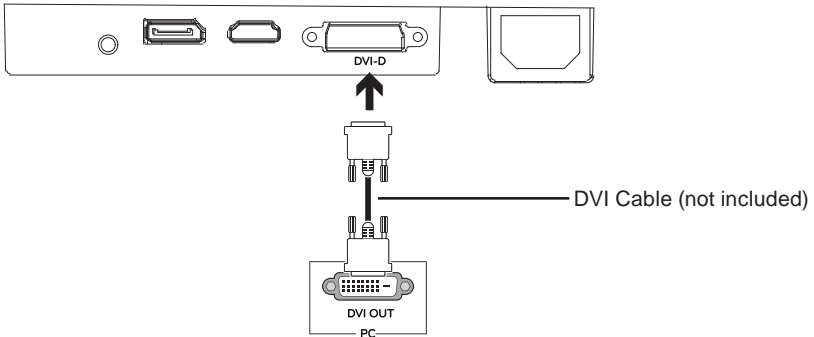

Section 7: Basic Operation

1. Insert one end of the DP cable into your PC's graphics card. Other connection types may be used. Additional cables not included.



For optimal refresh rate (or "performance"), it is recommended to use a DP (display port) or DVI-D dual link cable with the monitor's corresponding connector.

2. Connect the other end of the cable to the corresponding connector on your Monitor. See the image below.

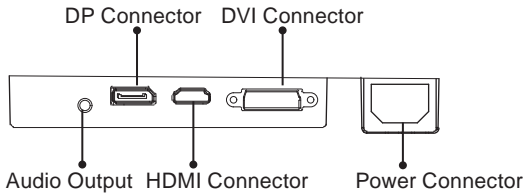

3. Connect the power cable to the monitor then connect the other end to your power source. It is recommended that you use a surge protector with adequate voltage if a wall outlet cannot be reached directly.
4. Locate the power button on the Monitor and press it to turn the Monitor on.

AMD FreeSync

The feature itself is off by default. In order to use this feature, please note you must have hardware with FreeSync capability, a DP cable, and the latest graphic drivers. To use this feature, connect your computer and monitor with a DP cable. After connecting, you may receive a prompt to enable the feature on your computer. If you do not receive the prompt, you may need to enable the function in your graphics card menu. See your graphics card manufacturer's documentation for instructions on how to turn on and/or enable FreeSync.

Section 8: Indicator Light

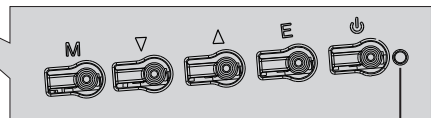
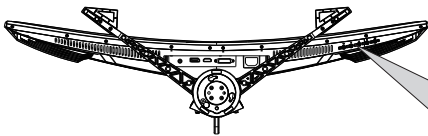

Indicator light

Solid blue light indicates power is on and the monitor is operating normally. Flashing blue light indicates no video source, no horizontal or vertical signal has been detected or power is low. Please ensure your computer is on and all video cables are fully inserted and/or connected.

Section 9: OSD

The On-Screen Display (OSD) Menu may be used to adjust your monitor's settings and appears on screen after turning on the monitor and pressing the **M** button.



When using the monitor for the first time, settings will automatically adjust to optimal settings according to your computer's specifications.

1. Press any one of the buttons (**M**, **▼**, **▲**, **E**, **⏻**) to activate the navigation window.



2. Press **M** button to enter the OSD screen.

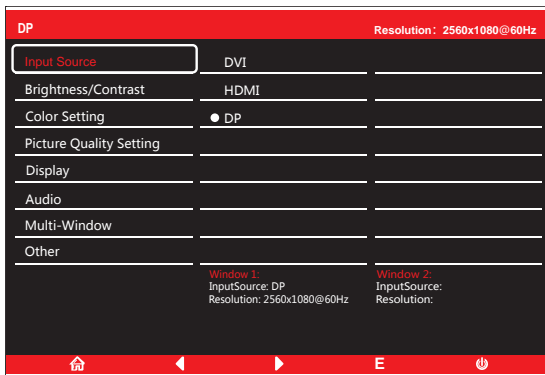

3. Press **▼** or **▲** to browse functions.
 - a. Highlight the functions you want to set, and press **M** to enter the sub-menu.
 - b. Press **▼** or **▲** to browse the sub-menu, and press **M** to highlight the functions you want to set.
 - c. Press **▼** or **▲** to highlight the options, and press **M** to confirm the settings and exit the current screen.
4. Press **E** to exit the current screen.

9.1 – OSD Menu Functions

Main Menu	Sub-Menu	Options	Description
Input Source	DVI	NONE	Switch to DVI signal input
	HDMI	NONE	Switch to HDMI signal input
	DP	NONE	Switch to DP signal input
Brightness/ Contrast	Brightness	0~100	Adjust display brightness
	Contrast	0~100	Adjust display contrast
	DCR	On	Turn on DCR function
		Off	Turn off DCR function
Color Setting	Gamma	Gamma 2.0	Set Gamma add-in
		Gamma 2.2	
		Gamma 2.4	
	Picture Mode	Standard, Text, Movie, Game, FPS, RTS	Set visual mode according to activity
	Color Temperature	Warm, Cool, User	Select color temperature
	USER	Red, Green, Blue	Customize RGB components
	Low Blue Light	0~100	Set blue light filtering level
	Hue/ Saturation	Hue, Saturation	Adjust hue and saturation levels
	Picture Quality Setting	Bypass	On, Off
Sharpness		0~100	Set display sharpness
Response Time		Off, High, Middle, Low	Adjust response time
Noise Reduction		Off, High, Middle, Low	Reduce the interference of image noise caused by signal source interference
Super- Resolution		Off, High, Middle, Low	When the resolution of the display screen is low, this function can be turned on to enhance the image resolution
Dynamic Luminous Control		On, Off	Compensate for gray scale display screen and strengthen the expression of gray scale
FreeSync		On, Off	Turn the FreeSync function on/off
Display	Aspect Ratio	Wide Screen, 4:3, Auto	Select on-screen aspect ratio
	DP Version	DP 1.1, DP 1.2	Select DP version
Audio	Mute	On, Off	Turn mute mode on/off
	Volume	0-100	Adjust audio volume
	Audio Source	Auto Source, HDMI, DP	Select audio signal input via HDMI or DP

Main Menu	Sub-Menu	Options	Description
Multi-Window	Multi-Window	Off, PIP Mode, PBP 2Win	Select PIP/PBP modes according to the number of input signals etc.
	Sub Win2 Input	DVI, HDMI, DP	Select according to input signal for PIP/PBP mode
	PIP Size	Small, Medium, Large	Adjust the PIP/PBP display window size
	PIP Position	Top Right, Top Left, Bottom Right, Bottom Left	Adjust the PIP/PBP window position
	Swap	NONE	Swap the two channel signal source of only the PIP/PBP 2 screens function
Other	Language	English, 简体中文, 한국어, Español	Set OSD language
	OSD H-Position	0-100	Adjust the OSD's horizontal position
	OSD V-Position	0-100	Adjust the OSD's vertical position
	OSD Transparency	0-100	Set the OSD's overall transparency
	OSD Time Out	5-100	Set how long the OSD remains open after non-use
	OSD Rotation	Normal, 90, 180, 270	When the user flips the display, this function can also flip the OSD to achieve the best display angle
	Reset		Reset monitor configurations

Section 10: ECO Modes and Gameplus Switching

- Press any one of the buttons (M, ▼, ▲, E, ⏻) to activate the navigation window.



- Press ▼ (ECO) button to switch ECO modes. These modes include Standard, Text, Movie, Game, FPS, and RTS and can be used to optimize settings according to your activity. Standard mode is suitable for most activities.

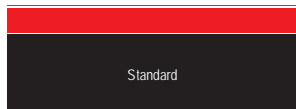

- Press **▲** (🎮) button to switch Gameplus modes. According to the needs of your game, choose the corresponding game icon. These game icons are primarily designed to optimize your aim during shooting games, though they can be used for other scenarios.



- Press **E** (🖱️) to set RGB range (Limited or Full) effects.

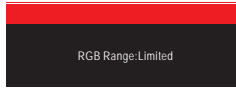

Section 11: Troubleshooting

11.1 – General Problems

The screen is blank

- Press the power button to turn the monitor on.
- Confirm the brightness and contrast settings are set normally.
- Check if the indicator light is flashing. If so, there is no signal from your video source.
- If your source is a notebook or laptop, make sure it's powered on and set to mirror or extension mode.

The image is out of focus

- Make sure the video cable is inserted properly at both ends.

The screen is flashing

- Plug monitor into a different power source. Insufficient power can cause this issue.
- Make sure devices such as non-shielded speakers, fluorescent lighting, AC transformers, table fans, etc., are a safe distance away from your screen to avoid magnetic disturbances.

The color bleeds or visual effects appear unusual.

- If your screen is all red or blue, or any colors disappear, check to see that the cable is properly inserted. A loose connection can cause a bad signal.
- Try connecting to another video source for comparison.

The screen appears to be scrolling, rolling, or moving unusually.

- Check that your source frequency is within 55-76Hz.
- Reconnect and ensure your video cable is secure.

The monitor needs cleaning

- Make sure the monitor has been powered off before cleaning.
- Always use soft, non-abrasive cloth when cleaning.
- Use dry, non-abrasive cloth to gently remove debris or dust.
- If necessary, lightly dampen a non-abrasive cloth with water and gently clean the surface.
- Never use alcohol or ammonia-based cleaning solutions.
- Never spray liquid directly onto any part of the monitor.

The indicator light does not work

- Check if the power is on.

- Make sure the power cable is properly connected to the monitor and power source.

Cannot plug and play.

- Check PC requirements to make sure it is compatible with the monitor.
- Check graphics card requirements to make sure it is compatible with the monitor.

Dim image

- Adjust the brightness and contrast ratio.

Image jitter/moire pattern

- Nearby electric equipment may be interfering with the monitor.

Light indicator is on or flashing, but there is no image displayed on screen

- Plug monitor into a different power source. Insufficient power can cause this issue.
- Check if the graphics card is installed properly.
- Make sure the power cable is properly connected to the monitor and power source.

Image position is not centered/the size is not right

- Please adjust Clock or Auto settings.

Color difference (colors are not optimized)

- Adjust RGB color settings or reset color temperature.

11.2 – PIP (Picture in Picture) Input Information

Mode	Home Screen Input Source	Picture in Picture Additional Input Source			Interchange Window	Picture Mode
		DP	HDMI	DVI		
Mode 1	DP	X	√	√	√	√
Mode 2	HDMI	√	X	√	√	√
Mode 3	DVI	√	√	X	√	√



“√” means this feature is supported while “X” means it is not supported.

11.3 – PBP (Picture by Picture) Resolution Information

To obtain an optimal viewing experience while using this feature, set both panels to the same resolution.

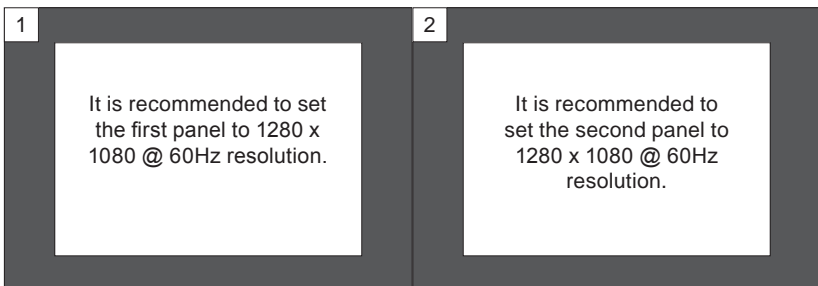

At this resolution, tearing and visual deformation should be minimized.

Section 12: Information

12.1 – Specifications

Item	Detail
Model Number	GN35DA
Screen Size	35"
Curvature	1800R
Viewing Angle	178° (H) / 178° (V)
Aspect Ratio	21:9
Resolution	2560 x 1080p
Backlight	E-LED
Typical Brightness	280 cd/m ²
Default Color Temperature	6500
Contrast Ratio	2000:1
Pixel Pitch	0.32 x 0.32mm
Response Time	6Ms
Refresh Rate	144Hz OC 200Hz
Ports	DVI, HDMI, DisplayPort (DP), Audio Out
Power	AC100-240V, 50/60Hz 2.0A
OSD Language	English, 简体中文, 한국어, Español
Environmental Temperature & Humidity	Operating temperature: 32°F to 122°F
	Storage temperature: -4°F to 140°F
	Operating relative humidity: RH 10% to 90% (non-condensation)
VESA Mounting	Additional bracket needed
Dimension (with Stand)	32.97 x 8.53 x 20.97 in
Net Weight (with Stand)	18 lbs / 8.13kg

12.2 – Resolution Compatibility for DVI/DP

System Requirements below are the minimum system requirements for your GN35DA monitor. The requirements are recommended in order to properly use all of the monitor's features and ensure high-quality picture.

Operating System: Windows® 7 / Windows® 8 / Windows® 10 64-bit (latest service pack) or higher, Processor (CPU): Intel® Core™ i5 or AMD Phenom™ II X3 or higher, Graphics Card: NVIDIA® GeForce® GTX 950 or AMD Radeon™ R9 380 or higher, Memory: 6 GB RAM All trademarks and registered trade names are the property of their respective owners.

Section 13: One-Year Limited Hardware Warranty

Your VIOTEK® GN35DA Curved Gaming Monitor ("Product") includes a One-Year Limited Hardware Warranty ("Warranty"). The Warranty covers product defects in materials and workmanship under normal use. This Warranty is limited to residents of the United States and Canada only and is available only to original purchasers. This Warranty gives you specific legal rights and you may also have other rights which vary from state to state. This Warranty starts on

the date of your purchase and lasts for one year (the "Warranty Period"). The Warranty Period is not extended if the Product is repaired or replaced. We may change the availability of this limited warranty at our discretion, but any changes will not be retroactive. Warranty services are provided by Viotek Warranty Pro ("WP"). If a hardware defect arises and a valid claim is received within the Warranty Period, at its option and to the extent permitted by law, WP will: (1) repair the hardware defect by using new or refurbished parts that are equivalent to new in performance and reliability; or (2) exchange the Product with a product that is new or refurbished which is substantially equivalent to the original product. This Warranty is for one replacement only of like-items and does not cover items out of production if the product is no longer made or stocked. This Warranty is not assignable or transferable. The original purchaser may call WP's toll-free number at 1-855-229-9472 for service requests. When a product or part is exchanged, any replacement item becomes your property and the replaced item becomes WP's property. This warranty only covers technical hardware defectiveness during the warranty period and under normal use conditions. WP does not warrant uninterrupted or error-free operation of this Product. This Warranty does not cover any damage due to: (a) transportation; (b) storage; (c) improper use; (d) failure to follow the product instructions or to perform any preventive maintenance; (e) modifications; (f) unauthorized repair; (g) normal wear and tear; or (h) external causes such as accidents, abuse, or other actions or events beyond our reasonable control.

Important: Do not disassemble the Product. Disassembling the Product will void this Warranty. Only WP or a party expressly authorized by WP should perform service on this Product.

DISCLAIMER OF WARRANTY: THE REMEDIES DESCRIBED ABOVE ARE YOUR SOLE AND EXCLUSIVE REMEDIES AND OUR ENTIRE LIABILITY FOR ANY BREACH OF THIS LIMITED WARRANTY. OUR LIABILITY SHALL UNDER NO CIRCUMSTANCES EXCEED THE ACTUAL AMOUNT PAID BY YOU FOR THE DEFECTIVE PRODUCT, NOR SHALL WE UNDER ANY CIRCUMSTANCES BE LIABLE FOR ANY CONSEQUENTIAL, INCIDENTAL, SPECIAL OR PUNITIVE DAMAGES OR LOSSES, WHETHER DIRECT OR INDIRECT. SOME STATES DO NOT ALLOW THE EXCLUSION OR LIMITATION OF INCIDENTAL OR CONSEQUENTIAL DAMAGES, SO THE ABOVE LIMITATION OR EXCLUSION MAY NOT APPLY TO YOU. THE DURATION AND REMEDIES OF ALL IMPLIED WARRANTIES, INCLUDING WITHOUT LIMITATION THE WARRANTIES OF MERCHANTABILITY AND FITNESS FOR A PARTICULAR PURPOSE ARE LIMITED TO THE DURATION OF THIS EXPRESS LIMITED WARRANTY.

DECLARATION OF CONFORMITY

This device complies with Part 15 of the FCC Rules.

Operation is subject to the following two conditions: (1) This device may not cause harmful interference, and (2) this device must accept any interference received, including interference that may cause undesired operation.

FCC RELATED INFORMATION:

This equipment has been tested and found to comply with the limits for a Class B digital device, pursuant to Part 15 of the FCC Rules. These limits are designed to provide reasonable protection against harmful interference in a residential installation. This equipment generates, uses, and can radiate radio frequency energy and, if not installed and used in accordance with the instructions, may cause harmful interference to radio communications. However, there is no guarantee that interference will not occur in a particular installation. If this equipment does cause harmful interference to radio or television reception, which can be determined by turning the equipment off and on, the user is encouraged to try to correct the interference by one or more of the following measures:

- Reorient or relocate the receiving antenna.
- Increase the separation between the equipment and receiver.
- Connect the equipment into an outlet on a circuit different from that to which the receiver is connected.
- Consult the dealer or an experienced radio/TV technician for help.

The manufacturer is not responsible for any radio or TV interference caused by unauthorized modifications to this equipment. Such modifications could void the user's authority to operate the equipment.

VIOTEK[®]

COPYRIGHT © 2019 VIOTEK. ALL RIGHTS RESERVED.