

nubryte



NuBryte Touchpoint & Mobile App User Guide

Contents

1.	DIY Hardware Installation	4
1.1	Safety Warning	4
1.2	Limited Warranty	4
1.3	Installation Requirements	4
1.4	A Note About "Gangs"	5
1.5	Package Contents	6
1.6	Locating Your Breaker and Turning OFF Power	6
1.7	Circuit Breaker Panel	6
1.8	Fuse Panel or Fuse Box	7
1.9	Lighting Requirements	8
1.10	Replacement of the Light Switch	9
1.11	Install the NuBryte Touchpoint Base Unit	12
1.12	Turn On the Power	12
1.13	Attach the Display Unit	12
2.	Setting Up NuBryte Touchpoint	13
2.1	NuBryte Touchpoint Setup Wizard	13
2.2	Tutorial	14
2.3	Download the NuBryte iOS App	14
3.	Internet Connectivity	16
3.1	Acceptable Configurations	16
3.2	Troubleshooting	16
4.	NuBryte Account	19
4.1	Introduction	19
4.2	Terms of Service	19
4.3	Creating an Account	20
4.4	Inviting Other Users	21
4.5	Adding NuBryte Devices	21
4.6	Account Management	22
4.7	System Updates	22
5.	Advanced Lighting Modes	23
5.1	How it Works	23
5.2	Setting Advanced Lighting Modes	23

6.	NuBryte Touchpoint Functions	25
6.1	NuBryte Touchpoint Buttons	25
6.2	Lighting Control	25
6.3	Security	26
6.4	Intercom	28
6.5	Main Menu	29
6.6	Climate	29
6.7	Clock/ Timer	30
6.8	Energy	31
6.9	Appearance/ Screen Saver	32
6.10	On-Screen Notifications	32
6.11	Settings	33
7.	NuBryte Mobile App	35
7.1	Sign Up/ Log In	35
7.2	Tutorial	35
7.3	Lighting	36
7.4	Security	37
7.5	Climate	39
7.6	Energy	39
7.7	Settings	40
8.	Caring for Your NuBryte Touchpoint	41
8.1	Caring for NuBryte Touchpoint	41
8.2	Cleaning NuBryte Touchpoint	41
9.	Additional Support Resources	42
10.	Regulatory Statement	43
	Appendix 1 - Switch Plate Clearance	45

1. DIY Hardware Installation

1.1 Safety Warning

Your safety is important. Please read these notes before installing.

! **CAUTION:** Use only with permanently-installed lighting fixtures. To avoid overheating and possible damage to other equipment, do not use to control power outlets (including switch-controlled lamps), fluorescent lighting fixtures, motor-driven appliances (e.g. ceiling fans with lights), or transformer-supplied appliances.

Installations should be performed in accordance with all national and local electrical codes. This product should not be installed on circuits where multi-way switches exist (two or more switches controlling the same light). NuBryte Touchpoint requires a neutral wire and cannot be installed without one.

If you are unsure or have questions about the installation, please seek the advice of a licensed electrician.

If you notice anything unusual about the electric supply to your light switch, such as loose wires, exposed cabling, burn marks, holes in the insulating materials or damage to the electric wires, STOP IMMEDIATELY and seek the advice from a licensed electrician.

The dimming option must only be chosen when using incandescent, halogen, or dimmable CFL or dimmable LED bulbs. Not all CFL and LED's are rated by their manufacturer as dimmable.

1.2 Limited Warranty

LUCIS Technologies warrants NuBryte products purchased and installed in the U.S./ Canada for one year. Full details can be found at www.nubryte.com.

1.3 Installation Requirements

- Wireless (WiFi) Router supporting 802.11 b/g/ or n
- Neutral wire in existing light switch box (*see Section 1.10 for more on identifying wires*)
- Single OR double gang Touchpoint switch (*see package for details*)
- Light controlled by one switch location, i.e. single pole switch (Not to be installed with a 3-way or multi-way switches).
- See *Appendix A* for the minimum clear space around the existing switch to insure the

Touchpoint has sufficient room from door frames, pictures, or other obstacles

- Copper wiring. Consult a licensed electrician if your home has aluminum wiring.
- Sufficient space in the electrical box. The NuBryte Touchpoint switch is comparable in size with manual dimmers and requires more space than a manual light switch. The minimum size of the box depends on how much space there is for the wires, wires nuts, clamps, Touchpoint switch, etc. to be physically inserted into the box, as well as insuring the box is large enough for the number and size of conductors, clamps, etc. in the box per the National Electric Code (NEC 314.16). A recommended minimum value for the amount of space required to physically fit everything into an existing box is 2.5" of depth in the box, although in some cases as little as 2" of depth may be sufficient. For new construction, an 18 cubic inch box for a single gang unit and 25 cubic inch box for a double gang unit is the recommended minimal value however in both existing and new construction, the box size may need to be increased further per NEC 314.16 depending on the amount of and size of conductors, clamps, etc. in the box.
- For mobile connectivity, ensure your phone runs on: Android 4.0 or higher, or iOS V7 or higher

1.4 A Note About "Gangs"

Within the electrical industry, an individual light switch is referred to as a "Gang". Simply put, a light switch panel with one switch in it is called a "single gang" switch, a panel with two switches is called a "double gang" or "2 gang" switch, and so on.

Alternatively, when multiple switches control a single light source, this is known as a Multi-Way switch. Variations of this term include 3-Way or 4-Way switches.

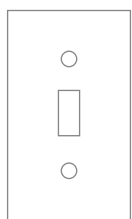

Single Gang

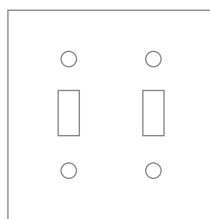

Double Gang

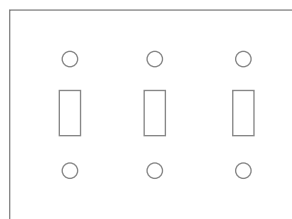

Three Gang

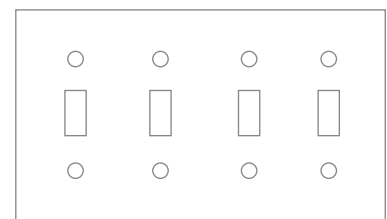

Four Gang

BEFORE PROCEEDING please ensure that you have purchased the correct "Gang" device for the locations where you plan to install NuBryte.

1.5 Package Contents

- 1 NuBryte Touchpoint LCD Display Unit
- 1 NuBryte Touchpoint Base Unit
- 4 Wire Connectors
- 2 Screws
- 1 Quick Start Guide
- 1 Window Decalsticker
- 1 Wire Label Sheet

NOTE: Double Gang unit contains an additional:

- 4 Wire Connectors, 2 Screws, and 1 Wire Label Sheet

1.6 Locating Your Breaker and Turning OFF Power

Shut OFF the power at the circuit breaker for the switch you are replacing. You may need to shut OFF more than one circuit breaker/fuse to ensure the switch you're working on is powered OFF., as well as any other wires that may be included in the same switch box.



CAUTION: Use a non-contact voltage detector to make sure that the power to your switch box is OFF before proceeding. For existing construction, ensure to check for voltage with the switch in both the On and Off position.

Depending on your home, the power supply may be controlled by Circuit Breaker Panel or a Fuse Box:

1.7 Circuit Breaker Panel

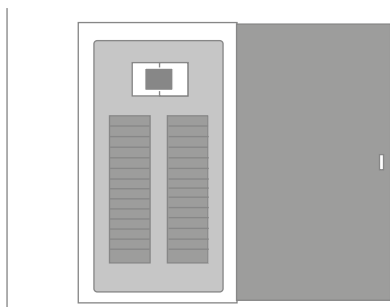

Typical Circuit Breaker Panel with Cover

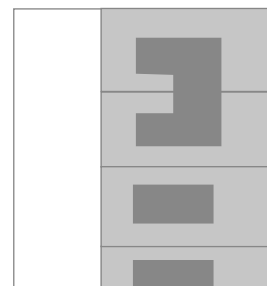

Closeup of Circuit Breaker Switches

- Most homes have a power panel using circuit breaker overload protection via an array of flip switches.

- As you see in Image A, the circuit breaker panel will have a MAIN disconnect circuit breaker at the top of the panel above the other circuit breaker switches. This controls power running to all of the circuits in the home.
- Below the MAIN breaker you will have multiple branch circuit breakers, which control the power running to individual circuits in your home. To install NuBryte, you will have to turn off the branch circuit breaker for the area of the home where the light switch to be replaced is located.
- If you are unsure of which branch circuit to shut off, shutting off the power via the MAIN disconnect circuit breaker may be the best way to proceed. **Note:** this will shut off power to your whole home and may mean having to reconfigure other Appliances in the home. Your home may have both a main electrical panel and sub panels. Ensuring to turn off the MAIN breaker in the main panel is the only way to make certain that power has been disconnected from all circuits in the house.
- When you have **completely finished** installing the NuBryte Touchpoint console turn ON the circuit breaker switches you turned off prior to installation

1.8 Fuse Panel or Fuse Box

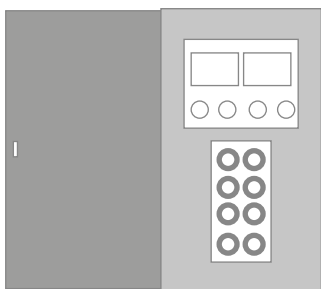

Older Style Fuse Panel / Box

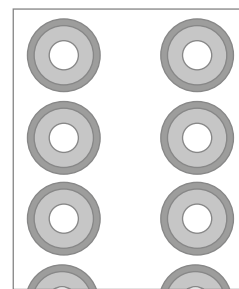

Closeup of Removable Fuses

- If you have an older home, you may find that you do not have circuit breakers, but rather, a fuse panel or fuse box. Typically resembling a door-covered metal box, they are often located in a stairwell, closet, basement or garage.
- The fuse box is the equivalent of the circuit breaker's electrical service panel. It differs by controlling the power running to circuits through the use of fuses instead of breaker switches.
- MAIN power for the home is controlled on the fuse panel by cartridge fuses, which simply pull out to disconnect.
- Branch circuits are controlled by screwing individual fuse plugs in and out of sockets on the panel. These large threaded sockets look like light bulb sockets and are called Edison sockets. To install NuBryte Touchpoint, you will need to disconnect power to the branch circuit where the light switch to be replaced is located. To do this, unscrew and remove the fuse controlling the circuit on which you will work.
- When you have **completely finished** installing the NuBryte Touchpoint turn power ON by screwing back in any fuses you had previously removed.

1.9 Lighting Requirements



CAUTION: Use NuBryte Touchpoint only with permanently-installed lighting fixtures. To avoid overheating and possible damage to other equipment, do not use NuBryte Touchpoint to control power outlets (including switch-controlled lamps), fluorescent lighting fixtures, motor-driven Appliances, or transformer-supplied Appliances.

NuBryte Touchpoint should only be installed in single-pole light switches, i.e. each fixture is controlled by only one light switch.

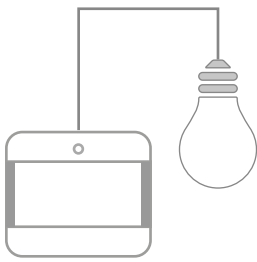

Replace with Single Gang NuBryte

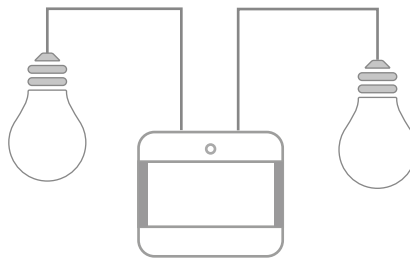

Replace with Double Gang NuBryte

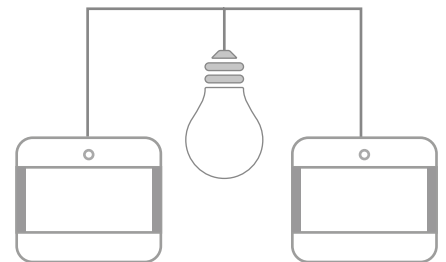

Multi-Way: Cannot be replaced by NuBryte

Selecting Light Bulbs

Single gang NuBryte Touchpoint can control one light fixture.

Double gang NuBryte Touchpoint can control two light fixtures independently.

To ensure optimal advanced lighting performance, we suggest using:

- **Dimmable LED** ($\leq 150W$ per light fixture)
- **Dimmable CFL** ($\leq 150W$ per light fixture)
- **Incandescent** ($\leq 300W$ per light fixture)
- **Halogen** ($\leq 300W$ per light fixture)

- **DO NOT** exceed the max power ratings shown in brackets above for each light fixture connected to your NuBryte Touchpoint. NuBryte also works with switches that control power to multiple light fixtures, as long as the combined max power controlled by the switch is less than the ratings shown in brackets above.

- It is not advisable to mix different types, or even brands, of light bulbs in the same light fixture. This may affect dimming consistency and performance.

1.10 Replacement of the Light Switch

Tools You Will Need

- Non-contact voltage detector
- Screwdrivers: Flathead and Phillips
- Pliers
- Wire stripper/cutter
- Electrical tape (optional)

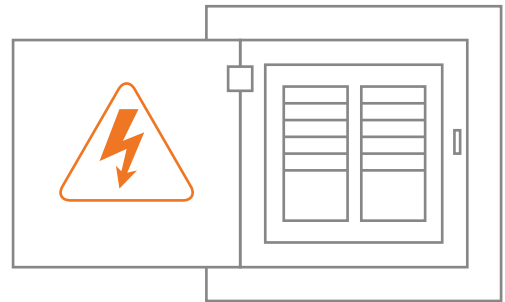

Circuit Breaker Panel/ Fuse Box

Single Gang Installation

1. First, **TURN OFF POWER** to the switch you want to replace (see Section 1.6: Locating Your Breaker).
2. Remove the light switch plate by unscrewing or pulling off its front panel, then unscrew the switch from the switch box located in the wall.

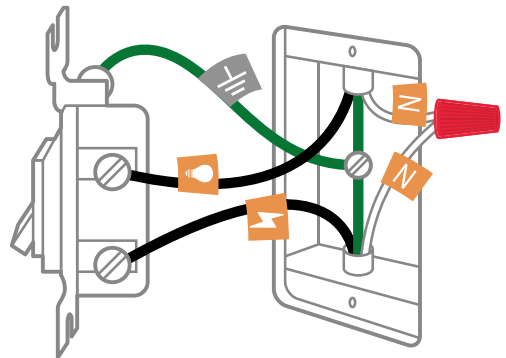

Unscrew old switch and label wires



CAUTION: Use a non-contact voltage detector to ensure that there is no power to any wires located in the switch box before proceeding.

3. Before detaching the wiring, wrap the provided wire labels around the wires coming from the wall to help you remember how they were connected to the switch. We suggest taking a photo at this point to refer to later on, if needed.
 - **Ground (⊕)** – Usually **Green** or **Green/ Yellow** in color. May also be a bare copper wire, or wrapped in paper. Optional for installation and not always present. If not present, use one of the included wire connectors or electrical tape to wrap around the bare connector coming from the Touchpoint switch so that it is not connected to anything and is not conductive.
 - **Hot/Live (⚡) and Load (💡)** – **Black** in color. Required to provide power to the switch and light. Comes from the electrical service panel and is always present. May also be **Red** in color.
 - **Neutral (N)** – White in color. Required for NuBryte, but not present in all switch boxes. **STOP** if you don't have a neutral wire and contact a licensed electrician to obtain information on the work involved to run a neutral wire to your switch box. You can also check our Community boards pages for information from other NuBryte users at www.nubryte.com/support.

Note: Color of wires may vary. Always use caution when working with electrical wiring.

If you are unsure how to proceed, please seek the advice of a licensed electrical professional. If you encounter wire colors that are not listed here, visit www.nubryte.com/support for additional resources.

4. Detach the wires from the old switch and, using the wire labels to guide you, use the included wire connectors (orange plastic caps) to attach the corresponding wires from the NuBryte base panel with wires coming from the wall.

How to Attach a Wire Connector

- Straighten any bent wire tips with pliers. Check to make sure you have about a ½ inch un-insulated tip at end of each wire. If not, use a wire-stripping tool to remove insulation from ½ inch of the wire's tip.
- Hold the stripped ends of the wires parallel and place the wire connector over them
- Twist the wire connector in a clockwise direction until the connector is secure and will not pull off.

Optional: After connecting the wires with the wire connectors, use electrical tape to secure the wire connector to the wires, ensuring the conductive area is completely concealed.

5. The live wire (⚡) (from breaker/fuse box) and load wire (💡) (from the light) should be connected as shown, but are interchangeable as they complete the same circuit.

Double Gang Replacement

1. First, **TURN OFF POWER** to the switch you want to replace (see Section 1.6: Locating Your Breaker).
2. Remove the light switch plate by unscrewing or pulling off its front panel, then unscrew the switches from the switch box located in the wall.

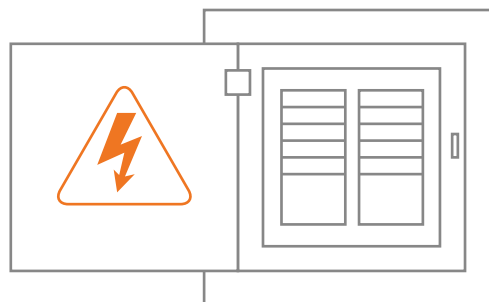

Circuit Breaker Panel/ Fuse Box



CAUTION: Use a non-contact voltage detector to ensure that there is no power to any wires located in the switch box before proceeding.

3. Before detaching the wiring, wrap the provided wire labels around the wires coming from the wall to help you remember how they were connected to the switch. We suggest taking a photo at this point to refer to later on, if needed.

- **Ground (⏚)** – Usually **Green** or **Green/ Yellow** in color. May also be a bare copper wire, or wrapped in paper. Optional for installation and not always present. If not present, use one of the included wire connectors or electrical tape to wrap around the bare connector coming from the Touchpoint switch so that it is not connected to anything and is not conductive.

- **Hot/Live (⚡) and Load (💡) – Black** in color. Required to provide power to the switch and light. Comes from the electrical service panel and is always present. May also be **Red** in color.
- **Neutral (N)** – White in color. Required for NuBryte, but not present in all switch boxes. **STOP** if you don't have a neutral wire and contact a licensed electrician to obtain information on the work involved to run a neutral wire to your switch box. You can also check our Community boards pages for information from other NuBryte users at www.nubryte.com/support.

4. Detach the wires from the old switch and, using the wire labels to guide you, attach the corresponding wires from the NuBryte base panel to wires coming from the wall using wire connectors (orange plastic caps, included).

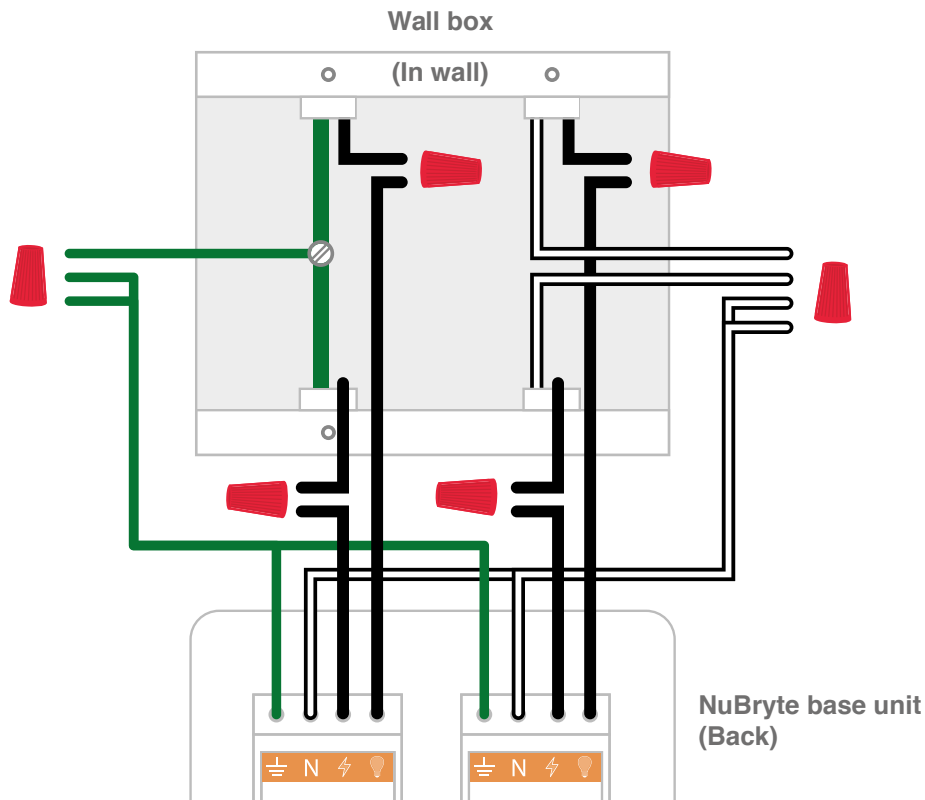

Typical Double Gang Wiring

Take care to note the following instructions:

- The Neutral (N) wires: One from each NuBryte dimmer (2), and those located in the switch box (3-4), should be wired to each other using a provided wire connector (up to 6 wires in total).
- The HOT/LIVE (⚡) wires: One from each NuBryte base unit (2), and wires coming into the switch box from the breaker/fuse box (2), should be wired to each other using a provided wire connector (up to 4 wires in total).
- A LOAD or OUTPUT (💡) wire from one NuBryte dimmer should be attached to a load (💡) wire from one light fixture using a provided wire connector. Repeat for the second light fixture.
- If GROUND WIRE(s) (⊥) are part of the switch box wiring, wire them to the ground wires from each NuBryte dimmer (2) using a provided wire connector (up to 4 wires in total). If no grounding option is available, use a wire connector to attach the two NuBryte ground wires to each other, in order to avoid the metal ends from contributing to a potential short circuit.

1.11 Install the NuBryte Touchpoint Base Unit

1. Carefully tuck the wires back into the in-wall switch box. If the wires are too bulky to fit into the box, it may be helpful to trim them to a shorter length before attaching with wire connectors.

2. Hold the NuBryte Touchpoint base unit in place, making sure it is straight and flush with the wall, while you screw it into the wall box, using the provided screws.

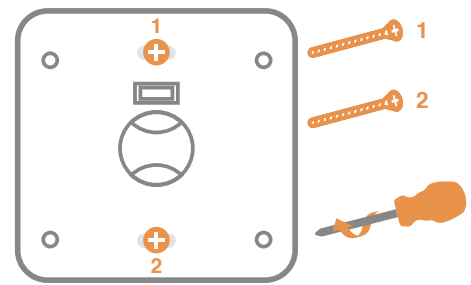

Screw Base Unit in place



Caution: Before proceeding please ensure the bulbs in your lighting fixtures do not exceed the maximum recommended wattage (See Section 1.9: Lighting Requirements-Selecting Light Bulbs)

1.12 Turn On the Power

1. Once you have screwed in the base unit into the wall switch box, return to your Breaker/Fuse box and turn ON the circuit breakers or screw back in any fuses you removed prior to installation (method depends on the panel type you have, see Section 1.6: Locating Your Breaker for details).

2. Press the mechanical on/ off and dimming buttons on the front of the base unit to make sure your wiring is correct and the lighting reponds.

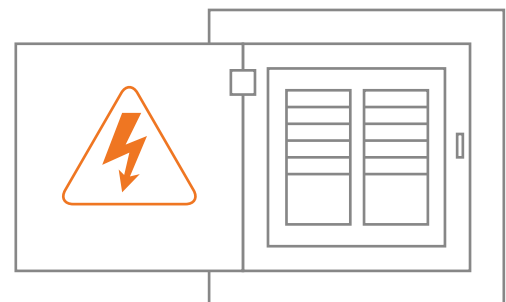

Circuit Breaker Panel/ Fuse Box

1.13 Attach the Display Unit

1. Attach the display unit by aligning the pegs on the back with the corresponding holes on the base unit. Once aligned, press the display unit into the base until you hear them click together.

Note: The display unit can be removed from the base unit with power On, but is not a normal scenario and is not recommended.

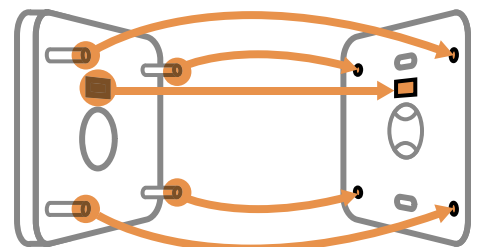

Align and click Display Unit in place

2. Setting Up NuBryte Touchpoint

2.1 NuBryte Touchpoint Setup Wizard

When the NuBryte Touchpoint display unit is powered on for the first time, it may take a moment to load before launching the Setup Wizard.

Please complete the entire Setup Wizard in order to properly configure your NuBryte Touchpoint.

To resume or return to the Setup Wizard, swipe the home screen to the RIGHT to access **Menu > Settings > Setup Wizard**.

- 1. Select WiFi Network** – Choose your network from the list that appears. The list will continuously refresh as new networks are found. Select your network and press the checkmark button to validate. If you have other NuBryte devices in your home, make sure every device connects to the same network. For troubleshooting regarding WiFi connections, please see *Section 3: Internet Connectivity*.
- 2. Enter Your WiFi Password** – Enter the password for your selected WiFi network. Press the “Show Password” option to check that the typed password is correct. Press the checkmark button to continue.
- 3. Which room is this NuBryte in?** – Choose from a list of available room types to indicate where your NuBryte Touchpoint is installed.
- 4. Name Your Nubryte** – Give your NuBryte Touchpoint a unique name to differentiate it from other NuBryte devices installed in the same room or home.
- 5. Name the Lighting Fixture(s) Wired to NuBryte** - Give each light wired to NuBryte a name.
- 6. Are Your Bulbs Dimmable?** – Select whether or not the bulbs installed in the light wired to NuBryte are dimmable. If they are, press the checkmark button. If not, press the x button to skip the next step.

Tip: You can find out if a bulb is dimmable on the bulb’s package, on the bulb itself, or by contacting its manufacturer. Bulbs that can’t be used on a dimmer should have the caution statement “not for use with dimmers” marked directly on the bulb.

- 7. Calibrate Bulbs** – If your bulbs are dimmable, slide the control bar as far LEFT as it will go without the bulbs flickering. You will need to repeat this step if you are using a double gang NuBryte console connected to two lights.
- 8. Select Time Zone** – Choose the time zone in which NuBryte is installed.
- 9. Set Date** – Set today’s date. This information should appear automatically after selecting the correct time zone, but it is a good idea to confirm that the information is correct.

10. Set Time – Set the current time. This information should appear automatically after selecting the correct time zone, but it is a good idea to confirm that the information is correct. Press the checkmark button to complete the Setup Wizard.

2.2 Tutorial

Once the Setup Wizard is complete, NuBryte Touchpoint will guide you through a brief Tutorial on how to use the lighting controls.

The Tutorial covers:

- Turning the lights on and off
- Dimming the lights
- Using All On and All Off multi-control
- Smart lighting tips
- Options to practice again or see tips for other modes

You can choose to skip the Tutorial and go directly to Lighting Mode if you wish. You may repeat the tutorial at any time by swiping the home screen to the RIGHT to access **Main Menu > Settings > Information > Light Practice**.

Tip: Have questions about Setup? Please visit us online at: www.nubryte.com/support

2.3 Download the NuBryte iOS App

- Download the NuBryte mobile for iOS from the Apple App Store by opening the App Store app on your iPhone and searching for “NuBryte”.
- A description of the app, along with information on modifications made to the latest version available can be found under the app store’s “Details” tab.
- Tap the “Get” button on the app listing screen and wait for it to download to your iPhone’s homescreen.
- Open the app and Sign Up for a new account, or log in if you already have an account or signed up online (*for more details on NuBryte accounts, please see Section 4*).

Note: If you have beta version of the NuBryte app installed on your iPhone, please be sure to remove the app by pressing and holding the app the icon in your iPhone menu until an x appears and then press x to delete. Please note that there is no need to delete the app from your phone prior to downloading an update from the App Store.

Note: The NuBryte iPhone app is not designed to run on iPads and as such will not display correctly, greatly affecting the user experience. A native iPad app is in development and scheduled to be released during 2016.

Please help us to improve our app by giving it a rating and posting a comment on the App Store after using it for some time. If you need support please visit www.nubryte.com/support for resources, tips and information on how to contact our team.

The NuBryte Android mobile App is in development and is scheduled to be released **Spring 2016**.

3. Internet Connectivity

3.1 Acceptable Configurations

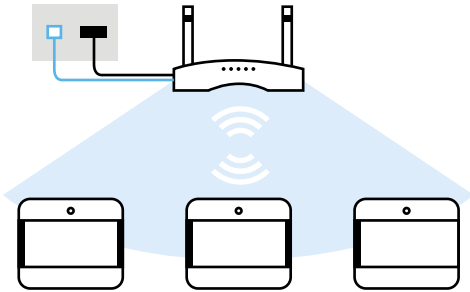

Typical WiFi Network Setup with NuBryte

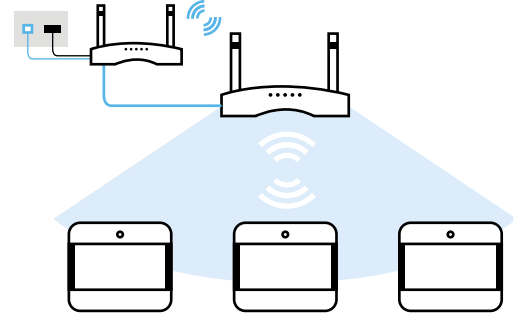

Access Point/ Sub-Net Setup with Nubryte

- In order to allow seamless control over all NuBryte devices installed within your home, they should all be connected to the same WiFi network.
 - In a typical WiFi network configuration, this means all of the NuBryte devices installed will be connected to the same WiFi router, which is in turn connected to your Internet server.
 - In more complex configurations, NuBryte devices can also operate on a network that is controlled by a router set to AP mode (Access Point mode) or sub-net mode (a local area network setup within your network). However, for all NuBryte units to be able to communicate with one another, e.g. to use Intercom Mode, they must all be connected to the same AP router or sub-net.
- In order to add your newly installed NuBryte Touchpoint to your NuBryte Account during Account Setup (see *Section 4 for details*), your smartphone must be connected to the same WiFi network.
- The maximum number of NuBryte devices that can be installed on one network is dictated by the internet router's capacity. Please check your router's specifications and consider the other devices you have in the home that also connect the network.
- WiFi performance is also dependent on the distance between NuBryte Touchpoint and the wireless router it is connected to. The closer the router is to the Touchpoint, the stronger the signal will be.

3.2 Troubleshooting

Cannot Find or Join Network in Network List During NuBryte Setup

1. Make sure you have a good WiFi connection at the location where the NuBryte device is installed. To do this, go to your NuBryte and swipe downwards from the top of the screen. You

will see two icons; a WiFi signal icon showing connectivity, signal strength and transmission and Cloud icon representing the connection to the NuBryte server.



If there is an issue with connecting to your WiFi router, the signal icon will appear greyed out.



If there is a problem connecting to the NuBryte server, the Cloud icon will be struck through.

Tip: Alternatively try checking the connection strength from the same location with a smartphone or laptop connected to the same network. Follow the steps below to troubleshoot connectivity issues.

2. If your NuBryte can find the network, but cannot proceed past the password screen after entering your network password, double check that the password is entered correctly. Launch the Setup Wizard and select the “Show Password” option to ensure correct spelling.

Note: The Touchpoint works with **WiFi 8.0.11 b, g, and n** which uses the **2.4Ghz frequency**.

3. If NuBryte still cannot connect to your WiFi network:

- Remove the display unit from the base unit.
- Next, unplug your WiFi router in order to turn it OFF and **wait for 10 seconds** before plugging it back in.
- After **at least 30 seconds** after turning the router back on, re-attach the NuBryte display unit to the base unit and allow it to load.
- Next, swipe the NuBryte display screen to the RIGHT to access **Menu > Settings > Setup Wizard** and try to connect to the network again.

4. If this doesn't solve the issue, use a pin to push the **RESET** pinhole button marked on the left hand side of the display unit when facing it. This will reboot the display unit software. All of your personal settings will be retained. The display unit must be attached to the base unit and powered on when performing this action.

5. If the connection issue persists, swipe the NuBryte display screen to the RIGHT to access **Menu > Settings > Information > Reset Device** and follow the instructions on-screen.

Note: This will **erase** your personal settings, preferences and energy data for this device. Energy data history will be restored once the product is reconnected to the internet and paired with your NuBryte account. Some data may be lost (several hours worth) depending on the time elapsed between the product being reset and the last energy data upload to the NuBryte servers (once daily at midnight).

If you still cannot connect NuBryte to your home WiFi network please seek the advice of a NuBryte support representative (see *Section 8: Additional Support Resources*).

Lost Connection with an Installed NuBryte

- 1.** If you can no longer connect to an installed NuBryte, i.e. the NuBryte no longer appears in the device list or lighting mode on the NuBryte App, make sure your smartphone and all NuBryte consoles are connected to the same WiFi network.
- 2.** If the problem persists, close and exit the NuBryte App completely on your smartphone.
- 3.** Open the App again from your phone's home screen, and go to **Menu > Settings > Device List** and **Refresh** the list.
- 4.** You should see all devices connected to the same WiFi network appear in the list (this may take several minutes). It should state if a device is **Paired** (orange icon) or **Unpaired** (grey icon) to the smartphone App. Select an unpaired device to pair it to the App for use.
- 5.** If the NuBryte device still does not appear, try to power off NuBryte and your router following the steps above in Troubleshooting: Cannot Find or Join Network in Network List during NuBryte Setup – Section 3.2.

4. NuBryte Account

4.1 Introduction

In order to control your NuBryte system remotely via your smartphone and take advantage of the full array of smart lighting features, you will need to sign up for a free NuBryte Account. You can do this either through the NuBryte mobile App (available on iOS, Android coming Spring 2016) or at www.nubryte.com.

Activating your NuBryte Account will open the following features:

- Remote control of your lighting, security and other NuBryte features via the App.
- The ability to set advanced lighting modes for the NuBryte system.
- Security notifications when outside the home and captured video clips.
- Event scheduling and reminders.
- Access to the NuBryte online Community at nubryte.com where you can receive technical support, speak with other users and the NuBryte team, and keep up to date on product news.
- If you don't own a NuBryte product, you can still sign up to access the NuBryte community and download and log into the mobile App. You will not, however, have access to product features until a NuBryte device is purchased, installed, and linked to your Account.

4.2 Terms of Service

Our Terms of Service detail the agreement between LUCIS Technologies as the manufacturer and provider of services to maintain the product, and the valued customer that purchases, installs and uses the product.

LUCIS details the terms for providing these services on-screen before you start using the console and the NuBryte mobile App. The customer must agree to the terms before they can begin using the service. To review the terms please go to www.nubryte.com/legal/terms

Please contact a support representative if you have any inquiries regarding the terms or the product.

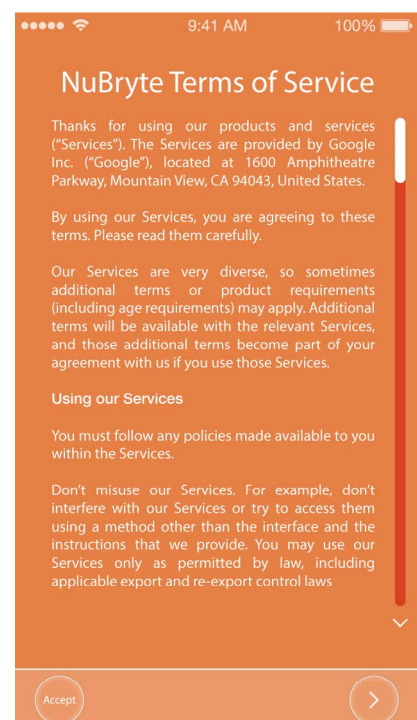

4.3 Creating an Account

I have Just Purchased My First NuBryte Products, but Don't Have a NuBryte Account

1. Download the NuBryte mobile App for your smartphone and launch it (see *Section 7: NuBryte App*).
2. Accept the Terms of Service, select the Sign Up option on the welcome screen and follow the prompts to set up your Account.

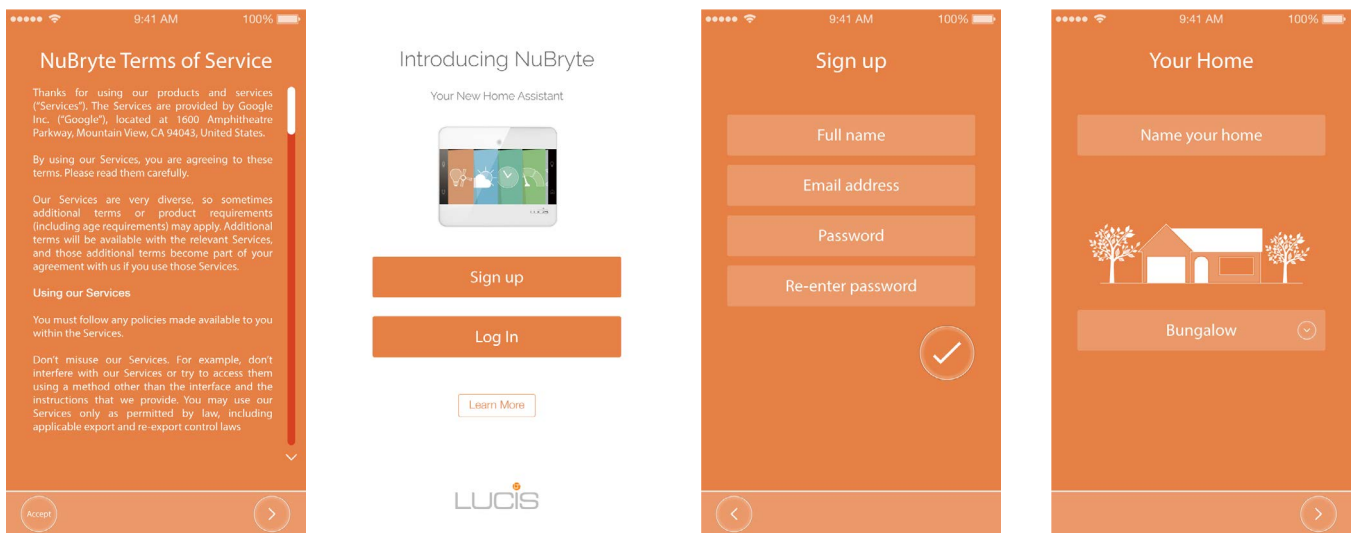

I Have Just Purchased My First NuBryte Products, But Already Have a NuBryte Account

1. You may already have an Account from signing up to our online community or mobile App.
2. Download and launch the NuBryte mobile App if you have not already done so, and use your existing NuBryte Account details to Log In. If you need help remembering your login information, use the "Forgot Log In" option to request access to your account.
3. If this is the first time you have installed a NuBryte product, after logging in, you may need to follow the steps above to configure NuBryte with the App.

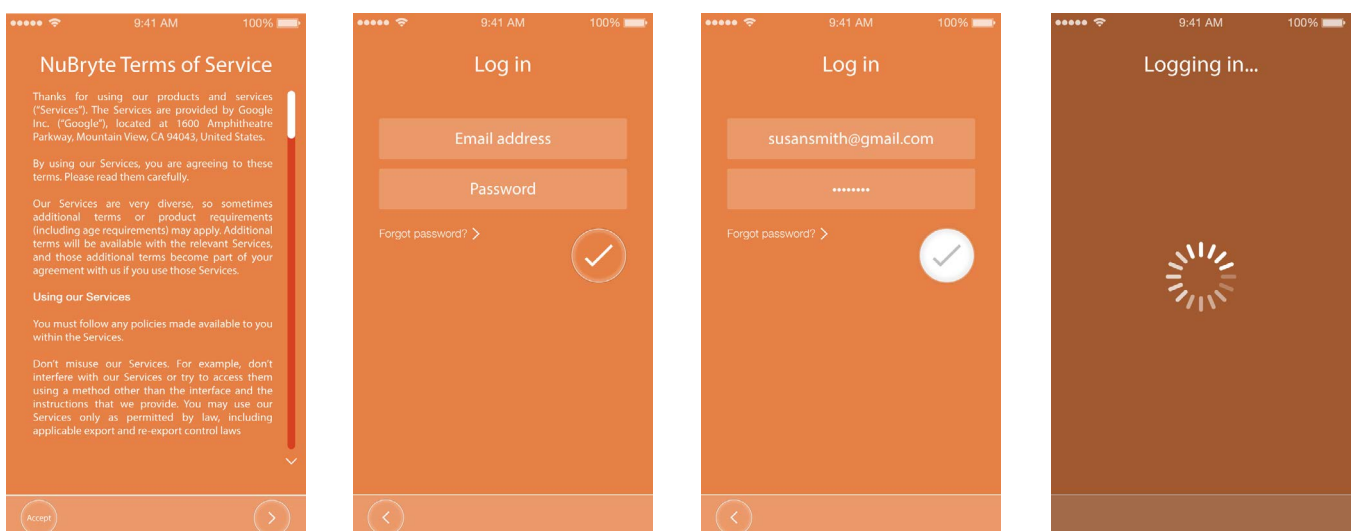

4.4 Inviting Other Users

1. The individual who purchases the product can easily sign-up for an Account, and then invite others that live in the home to create their own profiles within the same Account.

Note: The first individual who links the account to a NuBryte device is considered the Account Manager.

2. A NuBryte Account isn't just for yourself, but for also your home and any family member that will use NuBryte. We encourage NuBryte App users to be over the age of 13 to comply with Child Privacy rules. More information can be found at www.nubryte.com/webprivacy

3. You will be prompted to invite other users on the last step of the App setup, by entering their email addresses and sending an invitation. Further invites to use the account can be sent from **App > Settings > Manage Members**.

4. The new user(s) should receive an invitation email shortly thereafter. He/she will be instructed to open a link to a secure webpage at nubryte.com to enter his/her own username and password credentials to join the household's NuBryte Account.

5. Next, the new user can download the NuBryte mobile App and log in using his/her own credentials.

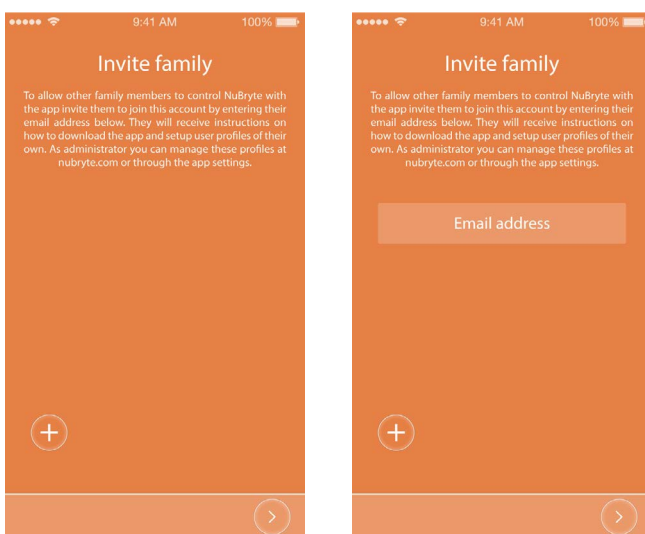

Inviting other potential users is part of the Sign Up process

4.5 Adding NuBryte Devices

1. To add new devices after signing up for your NuBryte Account, first install the product following the instructions provided, and then open the NuBryte mobile App. A pop-up message will display informing you that new devices have been found and are ready to add to you account. Select **Connect** to navigate to the **Device List**. **Note:** If the pop-up message does not appear then go to the device list via **Menu > Settings > Device List**.

2. You should see the new devices listed as **Unpaired**. If not, press the **Refresh** button to search your network and reload the list.

3. Select an unpaired device, check or edit the device name and room type and press **Save and Finish** to pair it to your account.

NOTE: Please ensure that any new devices are connected to the same WiFi network as all of the other NuBryte devices installed in your home, and that your smartphone is also connected to the same network.

4.6 Account Management

The first person that signed up for the household's NuBryte account is designated as the Account Manager or Administrator. This user will have access to some settings that other members will not, such as inviting other people to join the account. Swipe the home screen RIGHT to access **Menu > Settings** for a list of available options.

4.7 System Updates

- Once your NuBryte is connected to the Internet, it will automatically update itself when a new update is available. An update may add a new feature or fix minor issues found by the LUCIS team or our community of users. Any update that results in a change to our Terms of Service or Privacy Policy will require you to review and accept the new policy on-screen before continuing use of the product. Lucis will also notify you of changes to these policies by email.
- In the event where an update may result in a temporary outage of the service, LUCIS will notify you in advance of the scheduled maintenance via the NuBryte Touchpoint console and/or mobile App.
- When an update is complete, you will be notified of any changes that may affect the operation of NuBryte.
- You can check the software version the NuBryte system is currently running by swiping the home screen RIGHT to access **Menu > Settings > Information**.
- The NuBryte mobile Apps may also be updated from time to time. These updates can be initiated and managed through the relevant App stores on your smartphone.

5. Advanced Lighting Modes

5.1 How it Works

NuBryte offers its users a number of Advanced Lighting modes that, when activated, automatically control your lighting based on your movement and preferences. Here are some details on the first modes available to NuBryte users:

- 1. Vacation Mode** – Set a start and end date for your vacation and NuBryte will turn your lights on between the set start and end times while you are away. Use the Random feature to randomly turn the lights on and off when the mode is in effect.
- 2. Morning Wake Up Mode** – Set your usual wakeup time through the mobile App and NuBryte will brighten the lights from 0-100% over the five minutes preceding your set wakeup time to mimic a natural, wakeup with the sunrise.
- 3. Bedtime Mode** – Set the time when you normally go to bed and NuBryte will gently dim the lights from their current level to 0% during the thirty minutes before the set time – helping you to relax before bed.
- 4. Night Light Mode** – If a large movement is detected – such as getting out of bed – during your set start times and end time times, NuBryte will gently brighten the lights to 30%. This will help find your way around the home at night without impairing your night vision.
- 5. Motion Mode** – Motion Mode senses your motion through NuBryte, turning off lights in empty rooms and illuminating rooms as you enter them. You can set the start and end time for the mode so lights only turn on automatically when you need them to. You can also set the duration the lights stay on after sensing motion, before NuBryte turns them off.

5.2 Setting Advanced Lighting Modes

- Advanced Lighting control and settings are accessed from the NuBryte mobile App. Go to **Lighting Mode** and select the bottom left icon in the taskbar to enter **Lighting Modes**.
- A list of modes is available to choose from. Select one to see a description of what it does and follow the instructions to personalize its functions.
- Finally, choose a NuBryte Touchpoint you want the advanced lighting settings to be applied to and press **Set**. A message indicating the mode is set successfully will be displayed and the glowing room icon will indicate that smart lighting has been set to **ON** for this console.
- To turn OFF the advanced lighting mode, enter the mode from the list and select the NuBryte Touchpoint you want to turn OFF before pressing the **Off** button. A message indicating the mode has been deactivated successfully will be displayed.

- Once advanced lighting modes are set, the NuBryte App will communicate the settings to NuBryte and will adjust the lighting according to the mode(s) selected.

Note: Your smartphone must be connected to the Internet in order to successfully set an advanced lighting mode. Your NuBryte must also have an Internet connection and be connected to the NuBryte server. You will be shown an error message on the NuBryte App asking you to check your network connection if either or both devices are not connected to the internet when attempting to use it to control NuBryte (see *Section 3: Internet Connectivity for more information*).

6. NuBryte Touchpoint Functions

6.1 NuBryte Touchpoint Buttons

Lighting, Intercom, Security, and the Main Menu can be accessed through the touch buttons around the sides of the display. Details on each are listed below.



6.2 Lighting Control

1. On/Off – Approach the NuBryte console. When standing in front of the console the display will switch from the screensaver to the lighting mode. Press the On/ Off button at the center of the screen to control the light. If you have a double-gang NuBryte installed switches and dimming controls for both gangs will be displayed on the same screen.

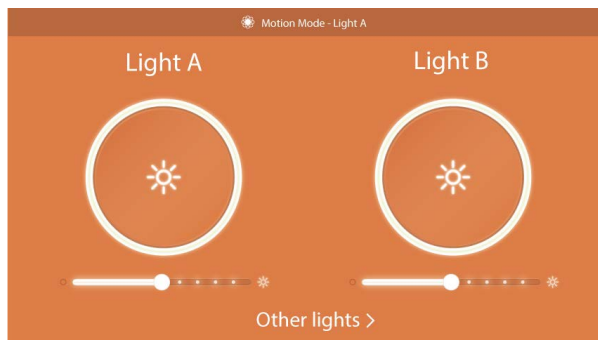
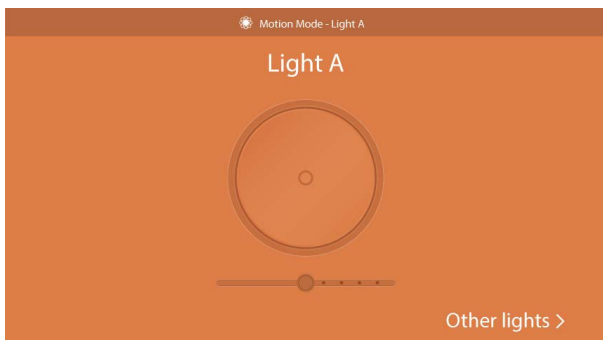

2. Dimming – Drag/ slide the dimming controls to change the brightness of the light.



Halo Control - Alternative Dimming Controls



Dial Control - Alternative Dimming Controls

3. Multi-Control – Press the **Other Lights** option to see all of the NuBryte light switches connected to your home WiFi network. Turn them on/ off individually or all at once. If you have more than 3 switches installed swipe LEFT to reveal the rest.

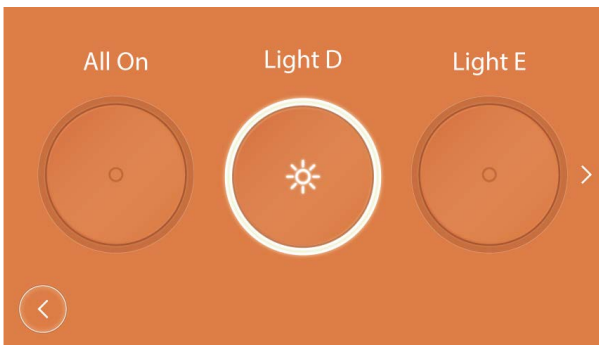

Other Lighting screen

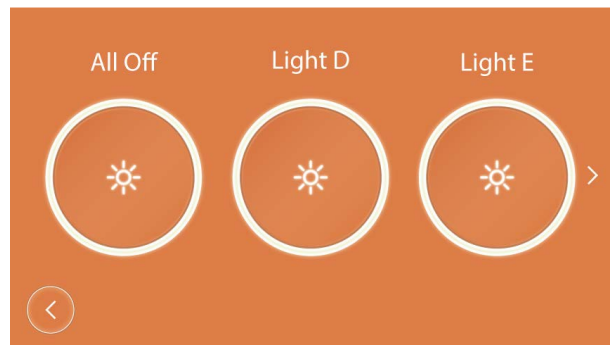

All lights ON, use ALL OFF to turn off

4. Advanced Lighting – When an advanced lighting mode is in operation, the advanced lighting icon will glow within the banner at the top of the screen, along with the name of the mode and the switch name the advanced light mode has been set to.



6.3 Security

- Activate Security Mode by pressing the button to the left side of the screen.
- If you are entering the mode for the first time, you will be prompted to set a 4 digit code, and then to confirm the code to ensure accuracy.

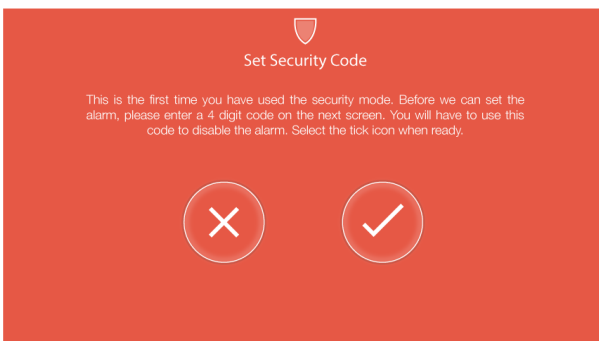

Message shown the first time activating Security

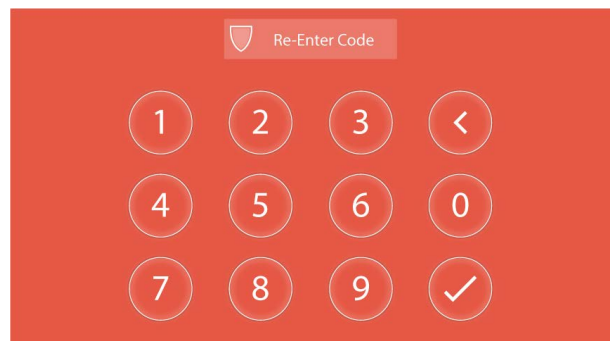

Pin code entry screen

Tip: Use a code that is easy to remember but not obvious to an intruder, and write it down in case you forget it! You will have to use the RESET DEVICE function to reset the code.

- You will also be asked to choose the countdown interval in seconds before the security mode is armed. Choose between 30, 60 and 90 second durations.
- Once the code and countdown duration has been set, press the security mode button again to activate security.

- You will then have 30/ 60/ 90 seconds (depending on the duration you chose) to exit the monitored area before the motion sensor is activated and the system is armed.

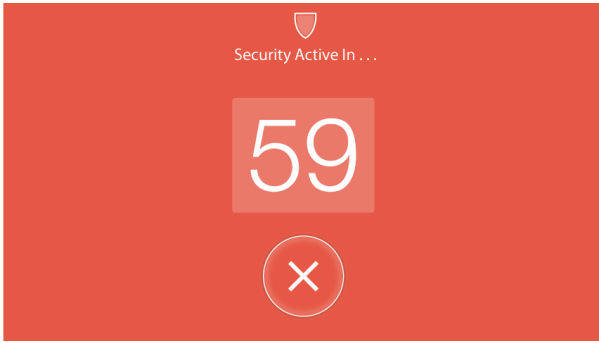

Default countdown duration is 60 seconds

- The alarm works in two stages:

1. Enter Code – Gentle Beep

- When NuBryte detects motion, an initial motion alert will sound, directing the user to the console. Tap the screen to awaken it and enter the designated 4-digit code. You will have 40 seconds to enter the code before the second stage starts.

2. Alarm Triggered – Loud Alarm

- If the 4-digit code is not entered within 40 seconds, a loud siren will sound and connected lights will flash to warn off intruders. The code can still be entered to disarm the alarm during the second stage “Alarm Triggered” alarm. The alarm will continue to sound until disarmed by the user, via either the NuBryte Touchpoint or the mobile App.

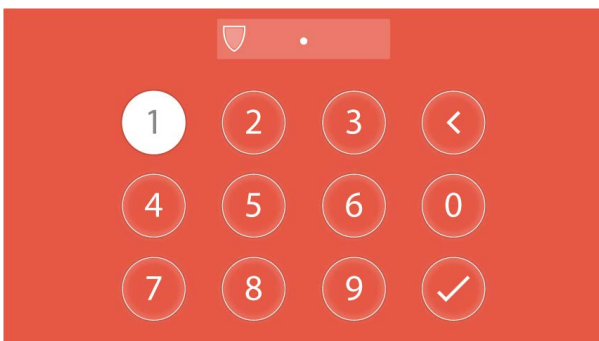

Enter Pin Code to disable alarm

- NuBryte Touchpoint features a built-in wide-angle camera that will begin recording a video clips as soon as the first alarm sounds, for a total duration of 90 seconds. Videos can be downloaded to your phone via the NuBryte App Security Mode for viewing, free of charge (data usage charged by your cellular provider may apply if not connected to a WiFi network).
- The built-in camera on NuBryte Touchpoint includes a Manual Privacy Shutter, located on the top of the console. To operate the manual shutter, slide the shutter to the LEFT (open) or RIGHT (closed). **IMPORTANT:** Security video footage will not be captured by the Manual Privacy Shutter when it is closed.



- If the alarm reaches the Alarm Triggered stage, everyone logged in to the NuBryte account will receive a notification on their smartphone that motion was detected and will be invited to view a video clip for the event.
- If more than one NuBryte Touchpoint is installed in your home the first to be triggered by motion will start recording video, sound the loud siren and flash the connected lights. Meanwhile, all other NuBryte Touchpoints will also flash connected lighting and be on alert to detect motion and record video as a potential intruder passes by. If motion is detected it too will begin recording a 90 second video clip.

Note: The loud siren will only sound at the first NuBryte to detect motion. Pets, such as cats and dogs, may trigger the security alarm when it is armed. This can result in you receiving false alarm notifications.

6.4 Intercom

Note: Intercom Mode requires that more than one NuBryte Touchpoint be installed in the home.

- Press the Intercom button to the left of the screen to enter Intercom Mode.
- **PRESS and HOLD** the touchscreen button for the room you wish to speak to, and speak in the direction of the display unit.

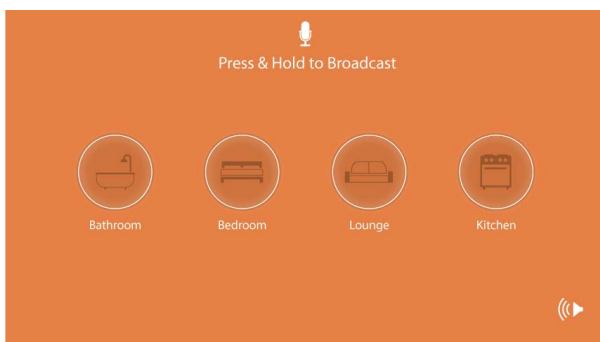

A view of all of the NuBrytes connected as rooms

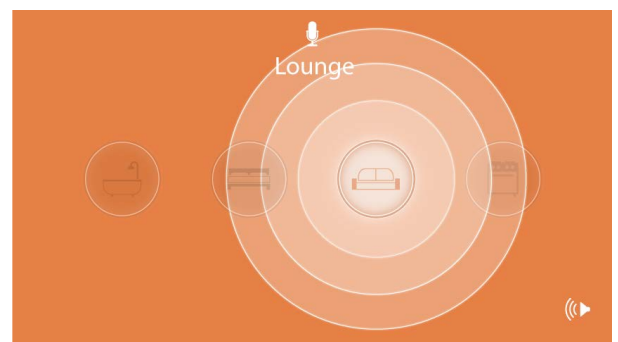

Press and hold a button before speaking

- **RELEASE** the room button to send your message.
- Listen for messages that others may be sending you. There may be a delay of several seconds, depending on your network signal strength and connection speed.

Note: Intercom Mode only functions in rooms where a NuBryte Touchpoint is installed.

- The intercom mode cannot currently be used from the NuBryte mobile App.

6.5 Main Menu

- Access the Main Menu by pressing the button to the right of the screen.
- From the Main Menu you can enter Lighting, Climate, Time, Energy and Settings modes.

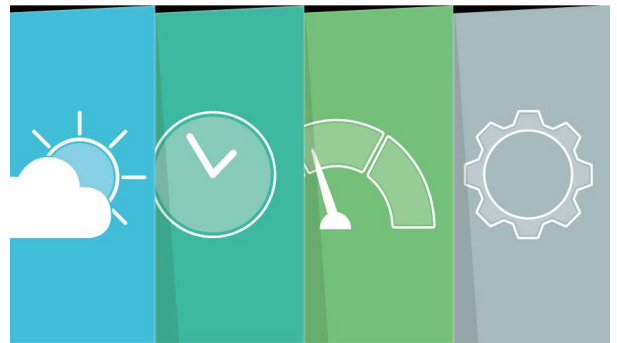
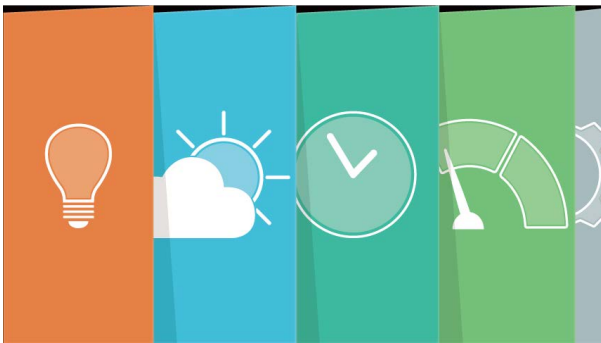

- Watch for new features in the Main Menu, via periodic updates to the NuBryte system.

6.6 Climate

- The Climate Mode details your home's indoor temperature and humidity conditions, as well as the weather forecast for your location.
- The first screen shows the indoor temperature and humidity for the area of the home in which NuBryte Touchpoint is installed, as well as the outdoor temperature.
- Swipe LEFT to see the current outdoor weather conditions, as well as today's high and low temperatures.

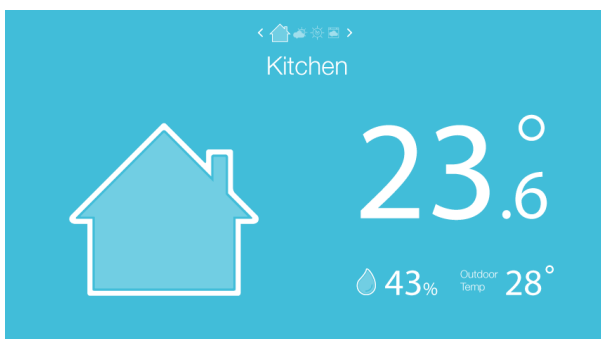

Environmental conditions of room NuBryte is installed



Current weather conditions for location

- Swipe LEFT again to see the hourly weather forecast for the coming 24 hours.
- Swipe LEFT to see the 5-day weather forecast in your area.

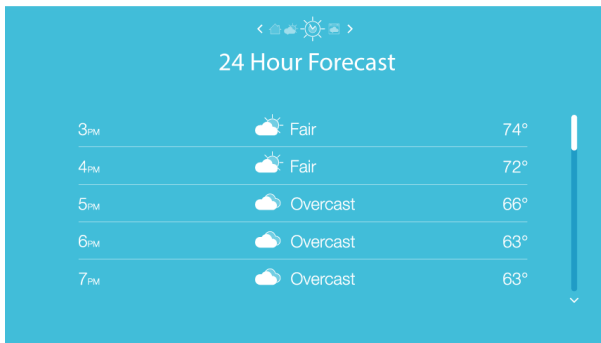

Scroll down list to see hour-by-hour forecast



Five day high and low forecast for location

Note: The weather forecast is determined by your geographical location according to your IP address. A third party provides this web-based service. You will be notified of any scheduled maintenance of the service that affects the performance of this feature by email or through the NuBryte Touchpoint and/ or mobile App.

6.7 Clock/ Timer

- Enter Time Mode to see the Current Time and Date.
- Swipe LEFT to set an Alarm. You can configure the alarm to repeat daily. When the alarm sounds, it will make a beeping sound and display an on-screen notification at the NuBryte Touchpoint.
- Swipe LEFT to set a Countdown Timer. Touch each field to set the hours, minutes and/or seconds for the timer. When the timer ends, it will sound and display an on-screen notification.
- When events are setup via the NuBryte App's Calendar Mode, the event will display a notification on NuBryte Touchpoint to inform the user when the event is due to start (see: Section 7: NuBryte Mobile App – Calendar).

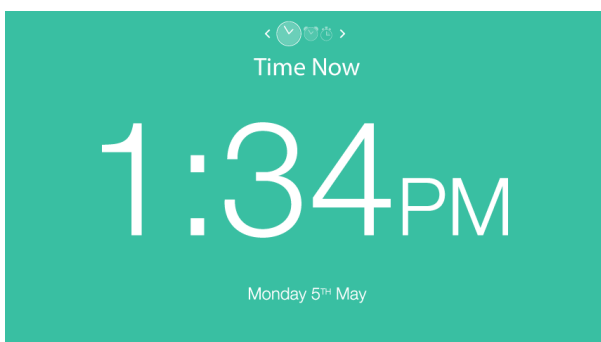

Current time in 12 hour clock format. Change format in the Time settings

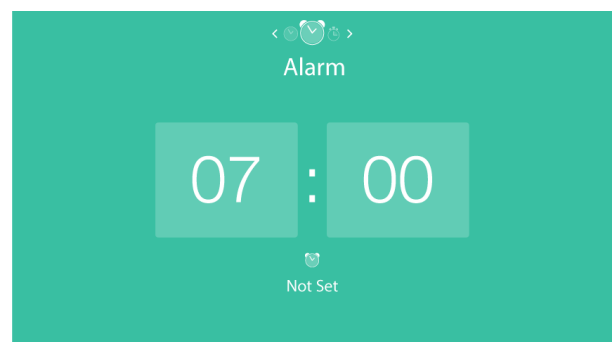

Shows Alarm not set. Press time to set and the alarm clock for Repeat options

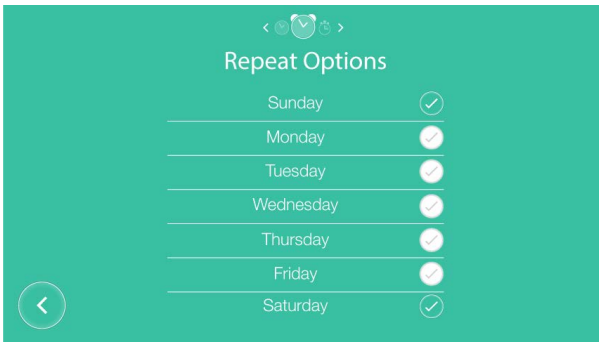

Check the day options to set a repeat alarm

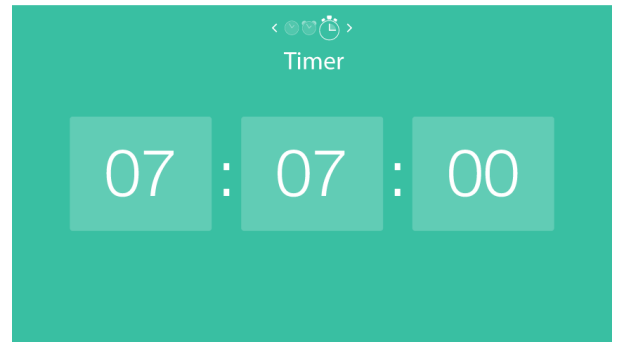

Touch the timer reading to set the duration

6.8 Energy

- Energy Mode shows a series of circular graphics that detail the energy consumption recorded each day for all NuBrytes installed in your home.
- Each graphic represents one day. If the consumption that day was higher than your average consumption, the graphic will flash.
- Energy consumption only represents the energy consumed by lighting connected to the NuBryte Touchpoint.
- You can enter the average cost of your electricity per kWh in the NuBryte General Settings options.
- Tap the center of the graphic to change the units from energy consumed (Wh and kWh) to money spent (\$).

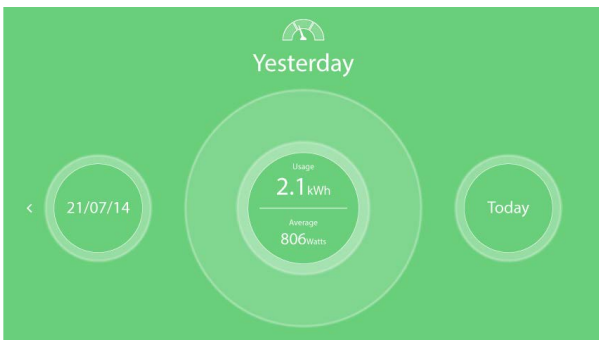

The NuBryte will show the last 7 days of energy use

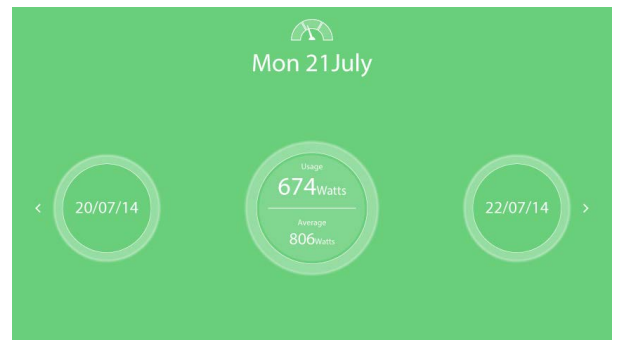

Swipe or touch circles to move between each day

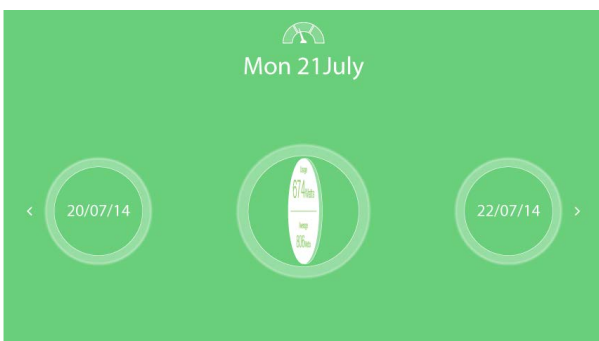

Press centre of circle to reveal estimated cost

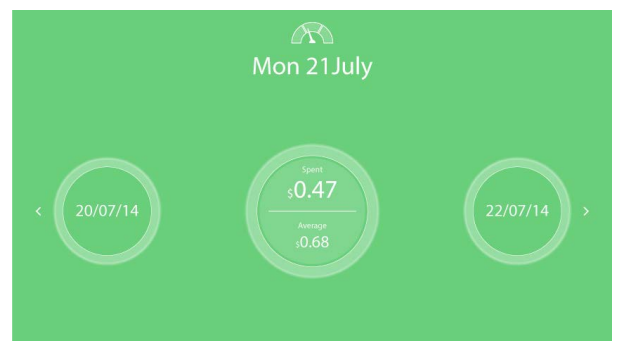

More energy info can be found in the mobile app

Note: Using the **RESET DEVICE** function from the Settings will also delete the energy data displayed in the NuBryte Touchpoint's Energy mode. However, once the device is re-connected to your wireless network and the NuBryte servers, this data will be restored. You may lose several hours of energy data recorded between the last time energy data was uploaded to the NuBryte server (everyday at midnight) to the time your reset the device.

6.9 Appearance/ Screen Saver

- The screen saver is activated when no motion is detected in close proximity to the console.
- By default, the screen saver alternates between the time, weather and any photo you have uploaded via the NuBryte mobile App for 30 seconds before going to sleep (black screen).
- Screen Saver preferences can be adjusted by swiping LEFT to access **Menu > Settings > Appearance**.

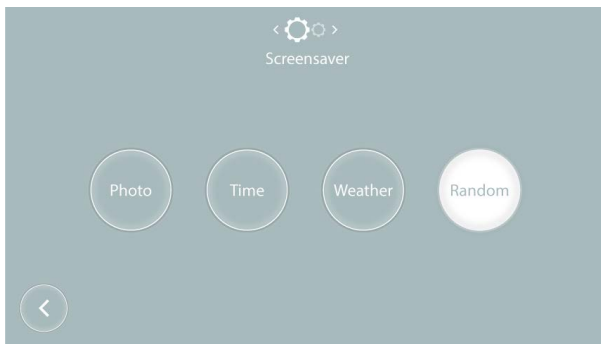

6.10 On-Screen Notifications

NuBryte Touchpoint will display the following notifications on-screen when appropriate:

- 1. Security** – After a security event reaches the second stage alarm, an alert will appear on-screen to notify the user when viewing the Touchpoint screen.

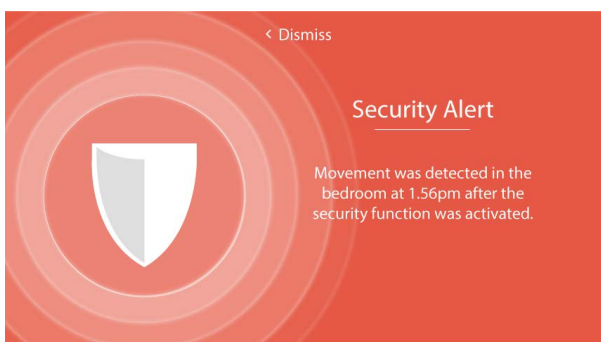

This notification will stay on-screen until dismissed

- 2. Events** – Any events set up by users of the NuBryte mobile App will be displayed on the NuBryte Touchpoint when the event is due.

3. Alarms & Timers – When an alarm is scheduled or a timer has finished counting down, a notification will appear on-screen.

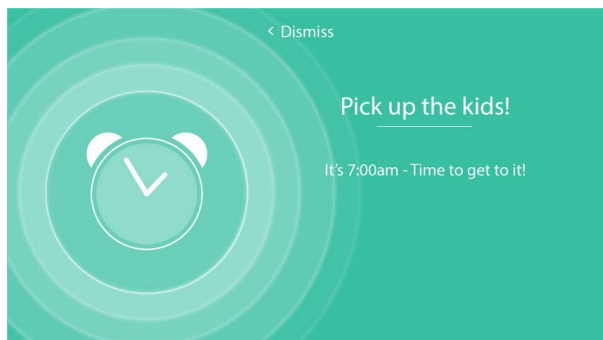

A beeping alarm will sound in combination with this notification

4. System Updates – Updates that require interaction from the user, such as agreeing to updated Terms of Service, will be displayed as an on-screen notification.

Note: Updates to NuBryte are typically scheduled at times the unit is less likely to be in use and in sleep mode (black screen) such as early morning. You will be notified by email in advance of any significant changes to the product's software.

5. Scheduled Maintenance – If maintenance for the NuBryte cloud is scheduled, which could interfere with the operation of your device, this will be communicated to you through an on-screen notification.

6.11 Settings

NuBryte's settings are split into various categories as outlined below:

1. General

- System volume
- Choose the room NuBryte is installed in
- Name your NuBryte Touchpoint
- Name the Lighting Fixture Wired to NuBryte
- Set the average cost of your energy per kWh
- Choose between Celsius and Fahrenheit temperature units

2. Network

- Select the WiFi network to connect to
- Enter the password for the selected WiFi network

3. Lighting

- Select between Halo, Dial, and Slider (default) lighting control types
- Choose between dimmable and non-dimmable bulbs
- Calibrate dimmable bulbs

4. Security

- Set a new 4-digit code used for Security Mode
- Select the Countdown Duration for Security Mode

Note: If you forget your 4 digit security code you will have to reset your device using the Reset Device function in **Settings > Information** and run the setup wizard again before pressing the Security mode button and setting new code.

5. Time

- Set the date
- Set the time
- Choose between 12 hour and 24 hour clock types
- Choose between digital and analog clock designs
- Choose between digital and analog timer designs

6. Appearance

- Choose between Clock, Photo Album, Weather, and Random (all three options) for the screen saver
- Setup Wizard
- Start the Setup Wizard to reset key settings for NuBryte

7. Information

- Firmware version
- MAC address
- Model Number
- Service Number
- Tutorial
- Tips
- Reset Device

7. NuBryte Mobile App

7.1 Sign Up/ Log In

- If you are a new user and don't have a NuBryte Account, choose the Sign Up option (*for more on NuBryte Accounts see Section 4*)
- If you already have an Account, select the Log In option. Enter your email address and NuBryte Account password to continue.
- NuBryte will save your log in credentials the first time you Log In so you do not have to enter them every time you open the App. If you Log Out from the App, you will be asked to log in again the next time you open it. Please keep a note of your Log In information in a safe place for future reference.

7.2 Tutorial

The NuBryte App Tutorial is similar to the NuBryte Touchpoint Tutorial and covers:

- Turning lights ON and OFF
- Dimming the lights
- Using multi-control
- Advanced lighting tips
- More tips for other modes
- You may repeat the Tutorial in the NuBryte App at any time at Menu > Settings > Tutorial.

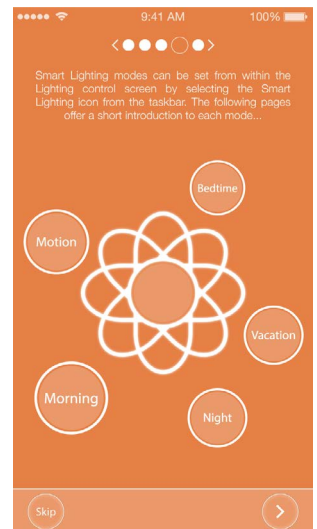
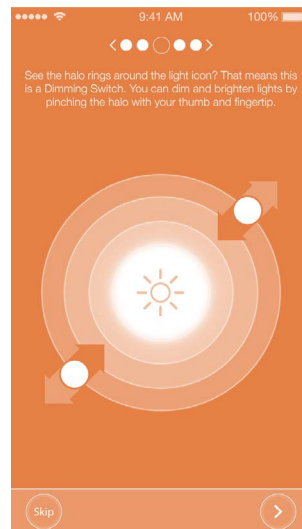
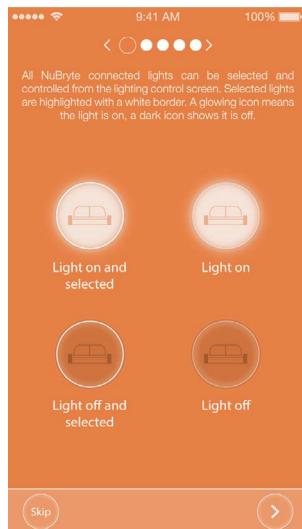
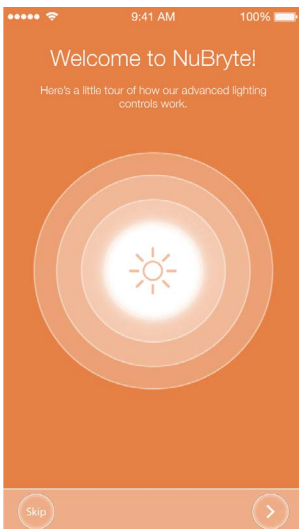

7.3 Lighting

- **On/Off** – Select the switch you want to control from the icons at the bottom of the screen. Press the On/ Off button at the center of the screen to control the light.
- **Dimming** – Pinch the dimming controls to change the brightness of the light.
- **Multi-Control** – Select a combination of switches, or all of them, with the “All Rooms” option then turn them on/ off together. If you have more than 4 switches installed, swipe LEFT to reveal the rest.

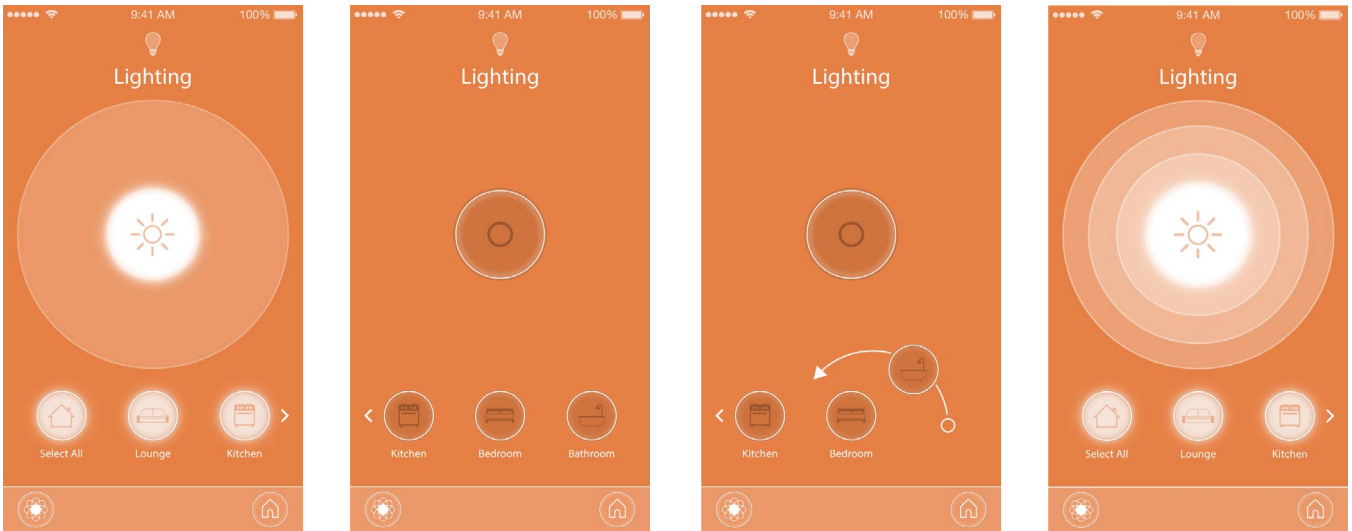

Non-dimmable light control

Switch appearance when light is off

Drag and drop switches to change order

Dimmable light control

- **Advanced Lighting** - Press the Advanced Lighting icon to set Smart Lighting modes.

Note – Depending on your setup, the start and end times of different modes may overlap, resulting in a configuration error. To avoid this, each advanced lighting mode is prioritized above one another according to the order listed below:

- 1. Vacation Mode** – Select the date range you are away using the sliding list. Next set the start and end times you want the lights to be on. Use the Random option to have the lights turn on and off automatically between the start and end times. Press “On” to activate the mode. Press the “Off” button to disable the mode.
- 2. Morning Wake Up** – Select which NuBryte(s) you want to set the mode to then set your wake up time by pressing the time displayed and adjusting the hours and minutes. Press “On” to activate the mode. Press the “Off” button to disable the mode.
- 3. Bedtime** - Select which NuBryte(s) you want to set the mode to then set your usual bedtime by pressing the time displayed and adjusting the hours and minutes. Press “On” to activate the mode. Press the “Off” button to disable the mode.
- 4. Night Light** – Select which NuBryte(s) you want to set the mode to then set you’re the time you want the nightlight mode to start and end. Press “On” to activate the mode. Press the “Off” button to disable the mode.

5. Motion Mode – Select which NuBryte(s) you want to set the mode to then set the time you want the mode to start and the time you want it to end (default is 6pm to 6am). Next choose the duration in minutes you want the lights to stay on for after detecting motion. Press “On” to activate the mode. Press the “Off” button to disable the mode.

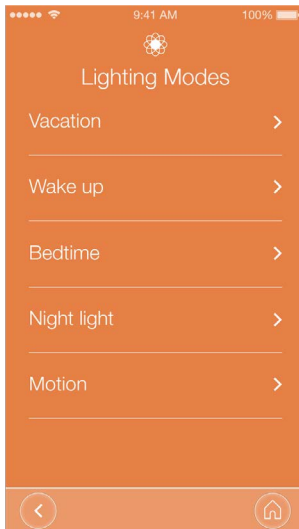

Lighting mode menu

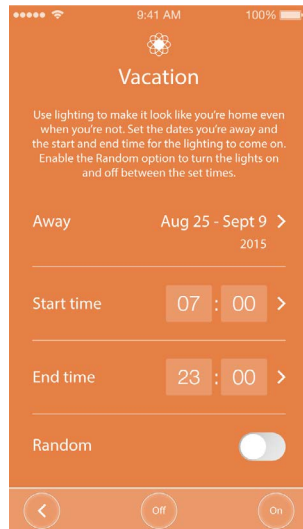

Vacation mode options

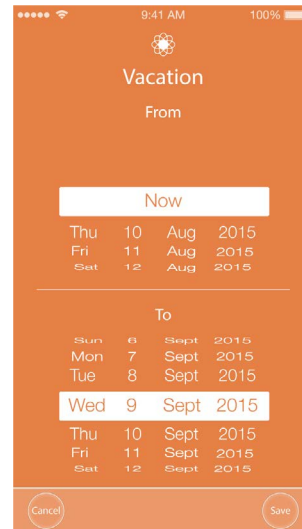

Vacation date range

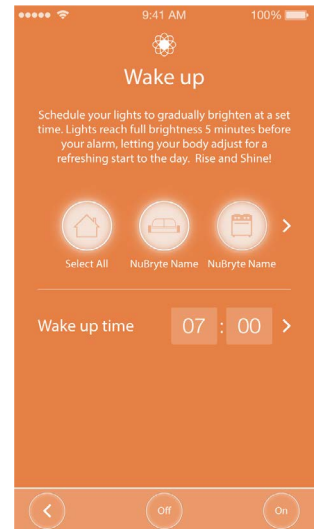

Wake Up mode options

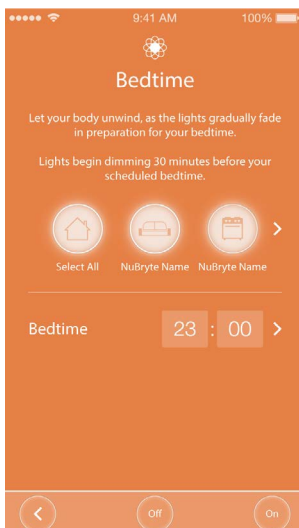

Bedtime mode options

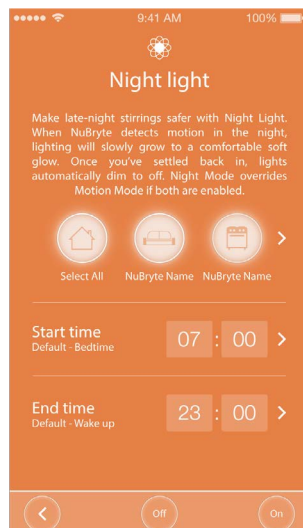

Night light mode options

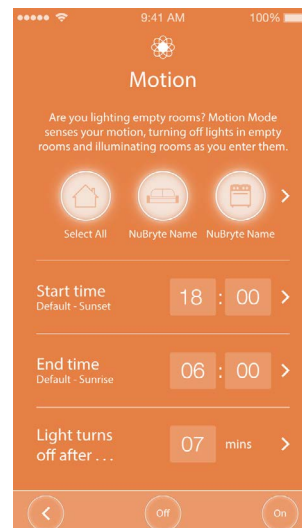

Motion mode options

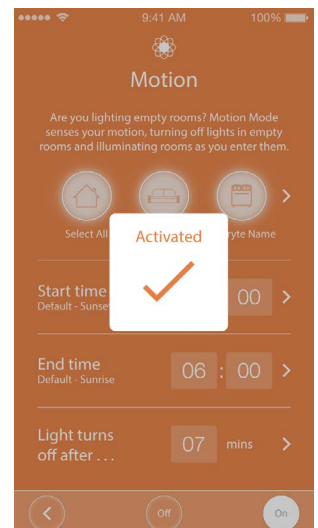

Confirmation the mode is set and active

7.4 Security

- **Activate Security** – This is the default screen shown when entering the Security mode. Select the large Activate Security button at the center of the screen to remotely arm your NuBryte security system. This will require you to enter your security pin and initiate a countdown.
- **Past Alerts** – This shows a record of all of the security alerts NuBryte has generated. A video clip accompanies each entry.



Security is not set

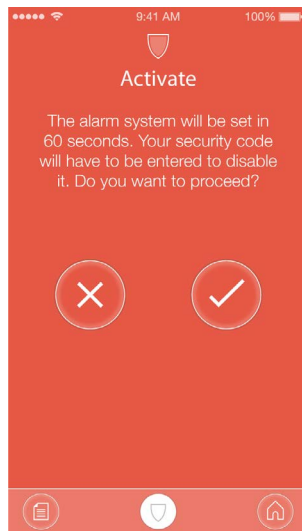

Confirmation notice

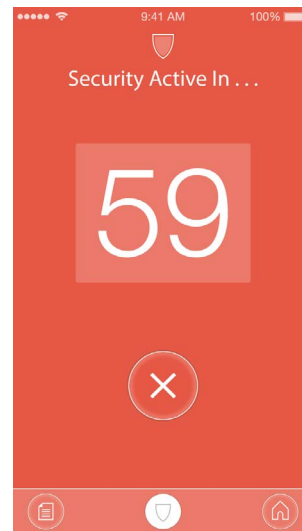

Security countdown

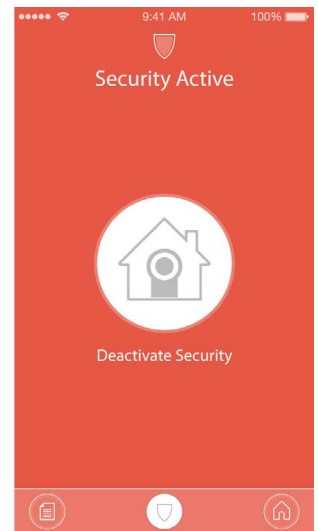

Press Deactivate button to disarm Security

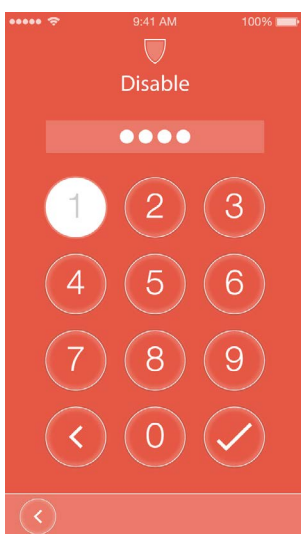

Enter security pin to disable alarm

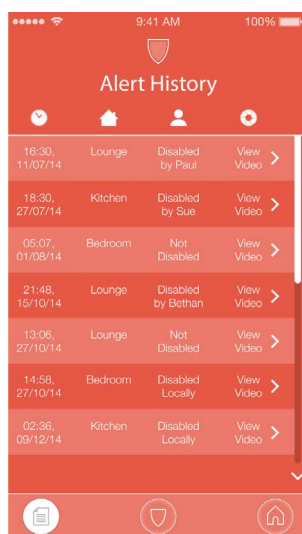

Download and view videos from list

Note: Videos will be available for download for a **maximum of 3 months after recording. 200MB** of cloud storage (around twenty 90 second videos) is available for **each NuBryte console**. When full, the oldest videos in the cloud will be overwritten by new video files. Videos can be deleted to free up space by swiping left and pressing the delete option. Downloaded videos will be saved to your smartphone's video album folder.

In the Event of a Security Alert

- When motion is detected and the alarm reaches the Stage Two “Alarm Triggered” level, the every user logged in will be alerted via a smart phone notification.
- The NuBryte App will open on the Security Mode Past Alerts screen and the user can press the **Download Video** option in the list to download the recorded video clip. Once downloaded press the **Watch Video** option and determine if there is a credible threat. Note the time and date the video clip was recorded. All alerts are organized by time, with the most recent featured at the top of the list.
- The alarm will continue to sound until a user from the account reacts the new notification and disables the alarm.

7.5 Climate

- The Climate mode on the NuBryte App details your home's indoor conditions.
- Every NuBryte Touchpoint contains a temperature and humidity sensor. Swipe **LEFT** and **RIGHT** to move between each NuBryte in your home to see the room's temperature and humidity compared to your location's outdoor temperature.



Use buttons in taskbar to switch between units

7.6 Energy

- Energy Mode shows a series of circular graphics that detail the energy consumption recorded each day.
- Each graphic represents one day. If the consumption that day was higher than your average consumption, the graphic will flash.
- Energy consumption only represents the energy consumed by lighting connected to the NuBryte Touchpoint.



- You can enter the average cost of your electricity per kWh in the NuBryte Touchpoint settings at **Main Menu > Settings > General Settings**.

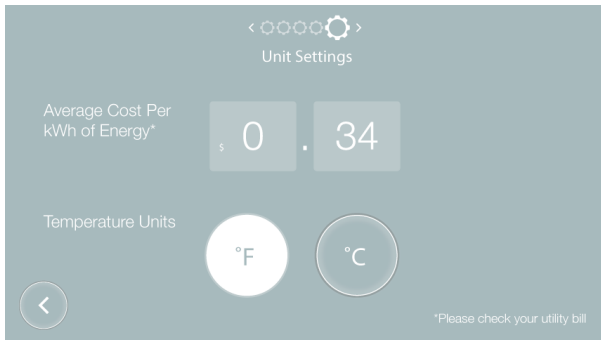

Check your utility bill and average the cost per kWh before entering in to your NuBryte settings

- Tap the center of the graphic to change the units from energy consumed (Wh and kWh) to money spent (\$).

7.7 Settings

The Settings available via the NuBryte App include:

- **Account Information** – Shows linked NuBryte account(s) and user ID(s).
- **Manage Family** – Shows list of users who have joined the NuBryte Account and allows the administrator to invite others by email.
- **App Tutorial** – Launches the Welcome Tutorial.
- **Device List** – Shows the devices that are paired and unpaired to your router and allows you to pair new devices.
- **Upload Photo** – Use this feature to upload a photo to your NuBryte Touchpoint screen saver.

8. Caring for Your NuBryte Touchpoint

8.1 Caring for NuBryte Touchpoint

- Keep liquids away from NuBryte Touchpoint.
- Regularly verify that the NuBryte Touchpoint Display Unit is securely attached to its base.
- Avoid unnecessarily removing the Display Unit from the Base Unit, as this may loosen connections over time.
- Keep NuBryte Touchpoint free of dust, and avoid installing in excessively dusty or humid environments.
- Use care to avoid scratching the touch screen display or device, by keeping it away from sharp objects or abrasive surfaces.
- Avoid dropping, compressing, or otherwise applying force to the NuBryte Touchpoint display unit or console.

8.2 Cleaning NuBryte Touchpoint

- Use a soft, lint-free cloth to wipe NuBryte Touchpoint clean of dust and fingerprints. Avoid paper towels, abrasive cloths, towels, and similar items that might cause damage.
- Don't get moisture into any openings.
- Don't spray cleaners directly onto the item.
- Don't use window cleaners, household cleaners, compressed air, solvents, ammonia, abrasives, cleaners containing hydrogen peroxide, or aerosol sprays.

If liquid does make its way inside your NuBryte Touchpoint, seek assistance the NuBryte support team as soon as possible. Liquid damage is not covered under the LUCIS product warranty.

NuBryte Touchpoint has an oleo-phobic coating on the screen; simply wipe the screen with a soft, lint free cloth to remove oil left by your hands. The ability of this coating to repel oil will diminish over time with normal usage, and rubbing the screen with an abrasive material will further diminish its effect and might scratch your screen.

9. Additional Support Resources

If, after reviewing the information in this User Guide you still have questions or need troubleshooting assistance, we welcome you to get in touch with our Support Team.

Online: nubryte.com/support

Email: hello@nubryte.com

Phone: 1-408-416-4444/ Toll-free: 1-888-675-9111

Social Media: [Facebook](#)

[Twitter](#)

[LinkedIn](#)

10. Regulatory Statement

FCC Compliance Notice

This equipment has been tested and found to comply with the limits for a Class B Digital Transmission System, pursuant to part 15 of the FCC Rules. These limits are designed to provide reasonable protection against harmful interference in a residential installation. This equipment generates, uses and can radiate radio frequency energy and, if not installed and used in accordance with the instructions, may cause harmful interference to radio communications. However, there is no guarantee that interference will not occur in a particular installation. If this equipment does cause harmful interference to radio or television reception, which can be determined by turning the equipment off and on, the user is encouraged to try to correct the interference by one or more of the following measures:

- Reorient or relocate the receiving antenna.
- Increase the separation between the equipment and receiver.
- Connect the equipment into an outlet on a circuit different from that to which the receiver is connected.
- Consult the dealer or an experienced radio/TV technician for help.

Operation is subject to the following two conditions:

- 1.** This device may not cause harmful interference.
- 2.** This device must accept any interference received, including interference that may cause undesired operation.

This device complies with part 15C of FCC rules. Privacy of communications may not be ensured when using this product.

Changes or modifications that are not expressly approved by Lucis Technologies can void the user's authority to operate the equipment.

FCC ID: 2AEONNUBRYTE

Model: NuBryte Touchpoint

RF Exposure Information

This equipment complies with FCC radiation exposure limits set forth for an uncontrolled environment. This equipment should be installed and operated with a minimum distance of 10 millimeters between the radiator and your body. This transmitter must not be co-located or operated in conjunction with any other antenna or transmitter.

Industry Canada (IC) Compliance Notice (PENDING)

This device complies with Industry Canada license-exempt RSS standard(s). Operation is subject to the following two conditions:

- This device may not cause interference, and
- This device must accept any interference, including interference that may cause undesired operation of the device.

IC RADIATION EXPOSURE STATEMENT:

This equipment complies with RSS-102 radiation exposure limits set forth for an uncontrolled environment. This equipment should be installed and operated with minimum distance 20cm between the radiator & your body.

Appendix 1 - Switch Plate Clearance

Use the scaled drawings below as a reference when installing NuBryte in your home:

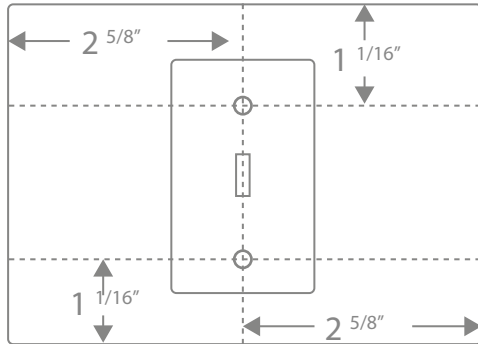

Required clearance to replace existing single gang toggle and round switch

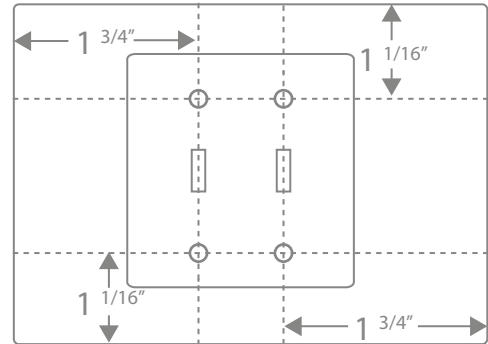

Required clearance to replace existing double gang toggle and round switch

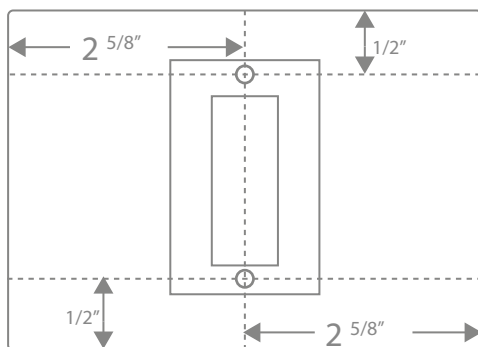

Required clearance to replace existing single gang rectangular switch

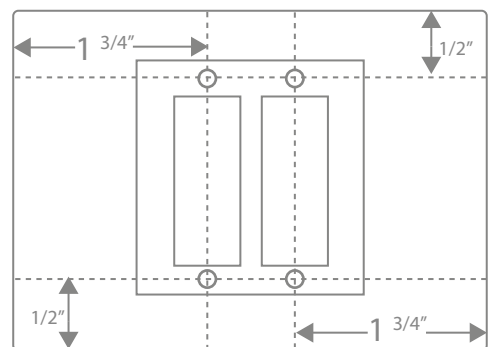

Required clearance to replace existing double gang rectangular switch

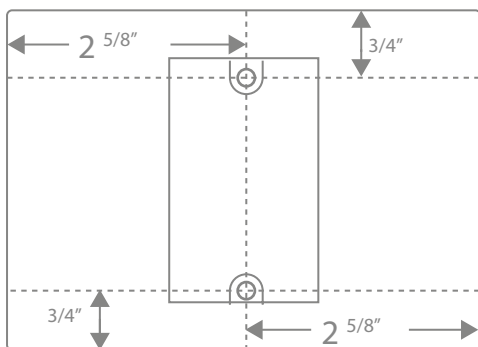

Required clearance for new construction single gang switch box

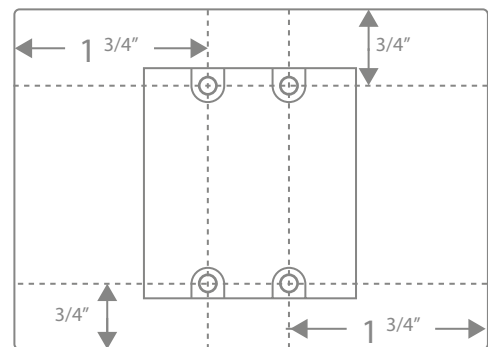

Required clearance for new construction double gang switch box

nubryte

www.nubryte.com

1-855-884-3890 (Toll free)

Lucis Technologies
1159 Sonora Court, Suite 320
Sunnyvale, CA 94086
www.lucis-tech.com