



OneSpace™

OneSpace is a Trademark of Comfort Products, Inc.

ASSEMBLY INSTRUCTIONS

MODEL # 50-812ES

SUPPLIER CODE: PMEX

8 Cube Organizer, Espresso

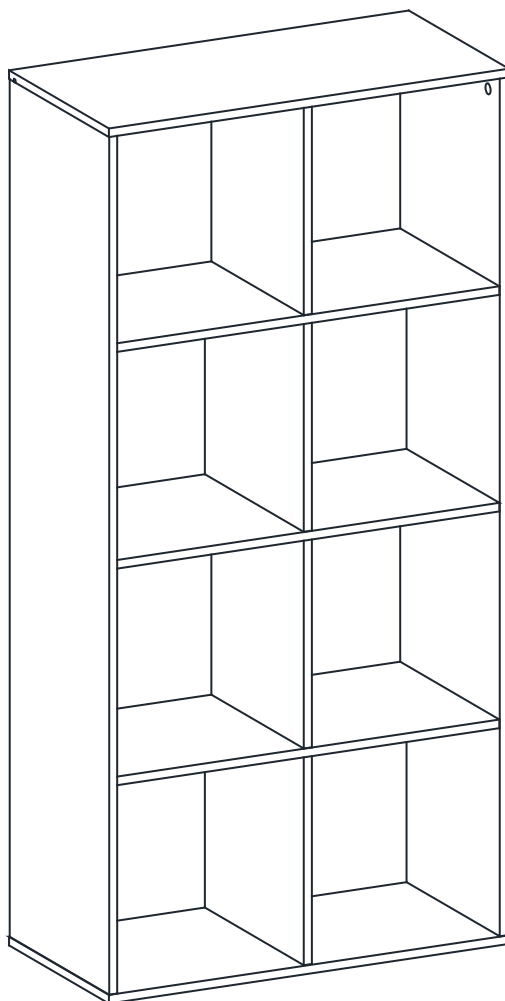

CUSTOMER SERVICE

For fastest service on claims, requests for replacement parts, or questions, please visit our website at

www.comfortproducts.net/support
e-mail: customerservice@comfortproducts.net

Keep your sales receipt as documentation of your ownership.

ASSEMBLY OVERVIEW

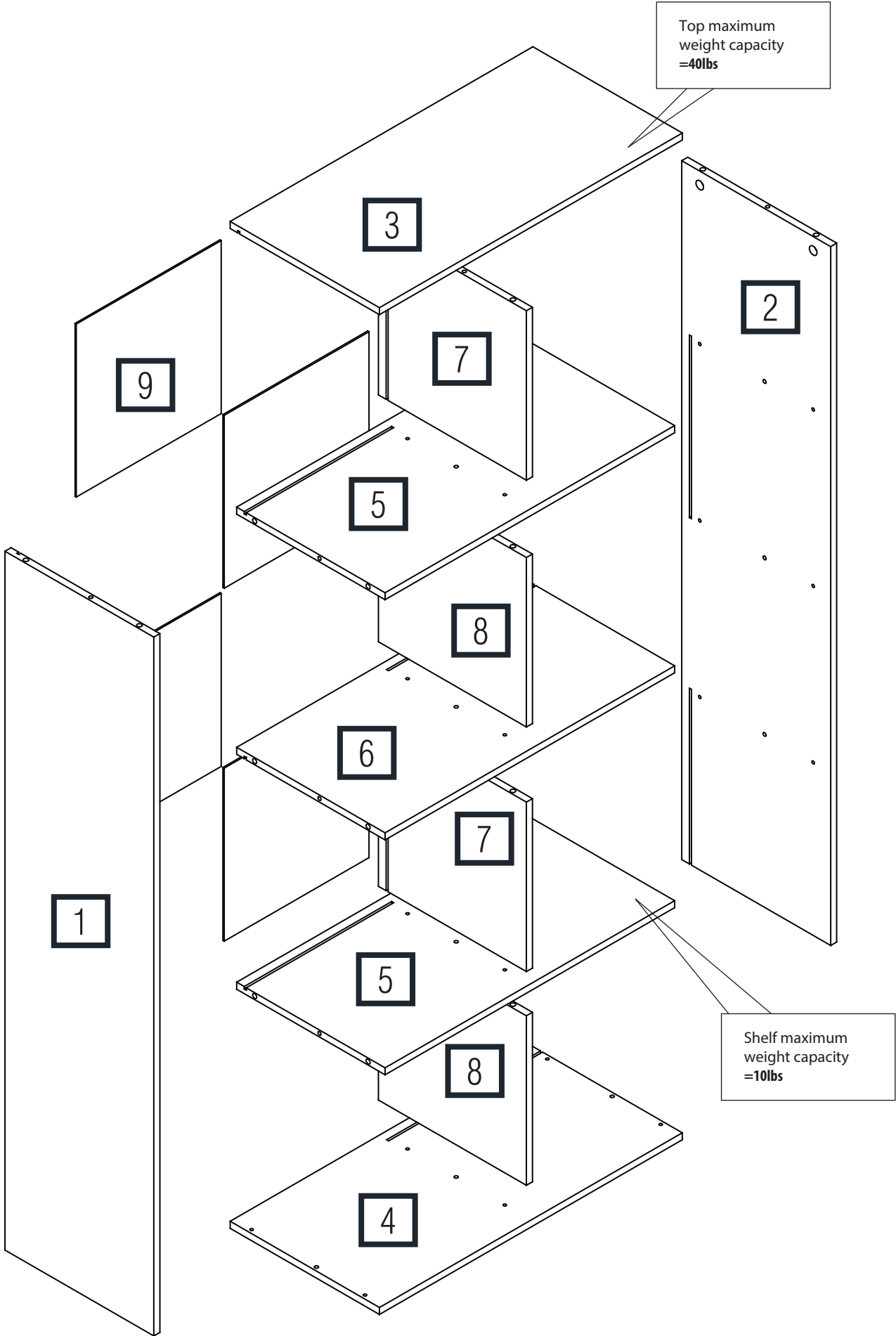





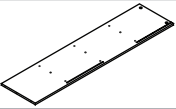
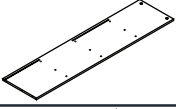
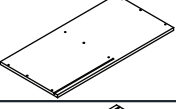
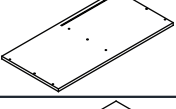
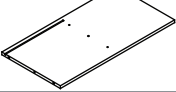

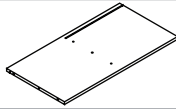
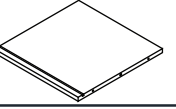
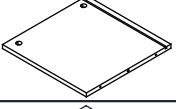
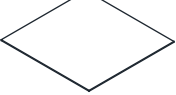
PARTS AND HARDWARE LIST

*Please look for part number on the side of the part. It either is stamped or has a labeled sticker.

PART	DESCRIPTION	STOCK NO	QTY
1	Side Panel Left 	51-812ESA	1
2	Side Panel Right 	51-812ESB	1
3	Top Panel 	51-812ESC	1
4	Bottom Panel 	51-812ESD	1
5	Shelf Panel A 	51-812ESE	2

PART	DESCRIPTION	STOCK NO	QTY
6	Shelf Panel B 	51-812ESF	1
7	Center Panel A 	51-812ESG	2
8	Center Panel B 	51-812ESH	2
9	Back Panel 	51-812ESJ	4

HARDWARE KIT
STOCK # 51-812ESKIT

PART	DESCRIPTION	QTY
A	Minifix Bolt 	24
B	Cam 	24
C	Wood Dowel (6 x 30mm) 	18
D	CSK Screw (M4.7 x 38mm) 	12
E	Cam Caps 	24
F	Allen Key (M4) 	1

CAUTION

- READ THE INSTRUCTION MANUAL BEFORE ASSEMBLING.
- REMOVE ALL PIECES BEFORE BEGINNING INSTALLATION.
- OPEN THE HARDWARE AS NEEDED.
- ASSEMBLE IN AN AREA WITH PLENTY OF SPACE.
- READ EACH STEP BEFORE BEGINNING CONSTRUCTION.
- HAVE THE TOOLS BELOW BEFORE YOU BEGIN ASSEMBLING.
- NEVER FORCE THE SCREWS OR FITTINGS.
- KEEP THIS MANUAL FOR FUTURE REFERENCE.
- TIGHTEN ALL THE SCREWS EVERY 6 MONTHS.
- DO NOT SHIFT OR DRAG THE PRODUCT AFTER ASSEMBLY.
- THE FOLLOWING TOOLS ARE NOT INCLUDED.

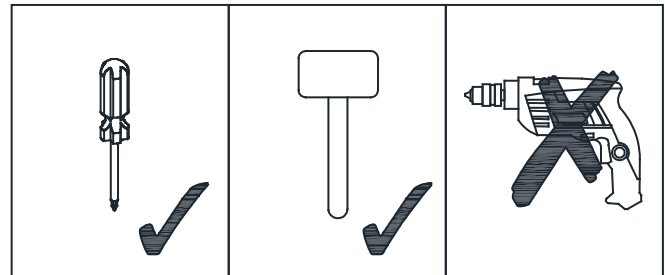

CLEANING AND CARE

- CLEAN SURFACES WITH A DRY OR DAMP CLOTH.
- DO NOT USE ABRASIVE CLEANERS.
- DO NOT USE FURNITURE WAX OR POLISH AS THE UNIT IS FINISHED WITH A PROTECTIVE CLEAR LACQUER.

REPLACEMENT PARTS

IF YOU ARE MISSING ANY OF THE PARTS ABOVE, OR IF YOU HAVE A DAMAGED PART, PLEASE VISIT WWW.COMFORTPRODUCTS.NET/SUPPORT REFERENCE THE MODEL # ON THE FRONT OF THIS MANUAL. SIMPLY COMPLETE THE INFORMATION, INCLUDING THE PART YOU NEED. THE PART WILL NORMALLY BE SHIPPED WITHIN 48 HOURS.

ASSEMBLY INSTRUCTION

Step 1:

Start assembling by fixing the Wood Dowels (C) to Side Panel Left (1), Side Panel Right (2), two Shelf Panels A (5), Shelf Panel B (6), two Center Panels A (7) and two Center Panels B (8).

Part # C  x 18

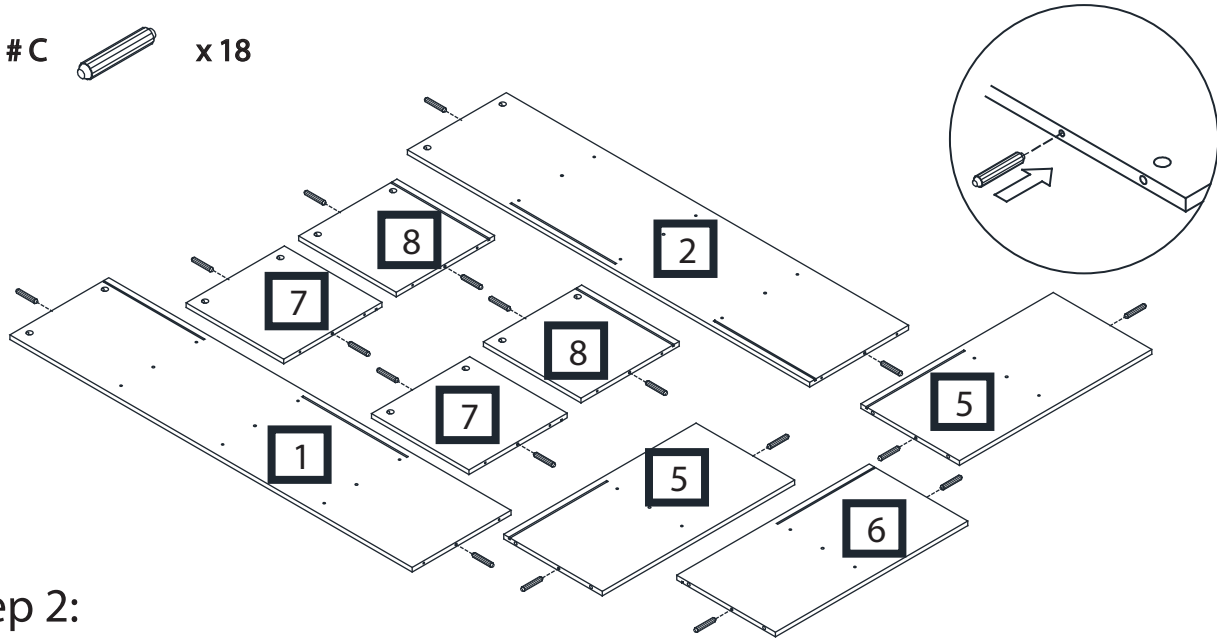

Step 2:

Using a phillips head screwdriver, fix the Minifix Bolts (A) to Side Panel Left (1), Side Panel Right (2), Top Panel (3), two Shelf Panels A (5), and Shelf Panel B (6).

Part # A  x 24

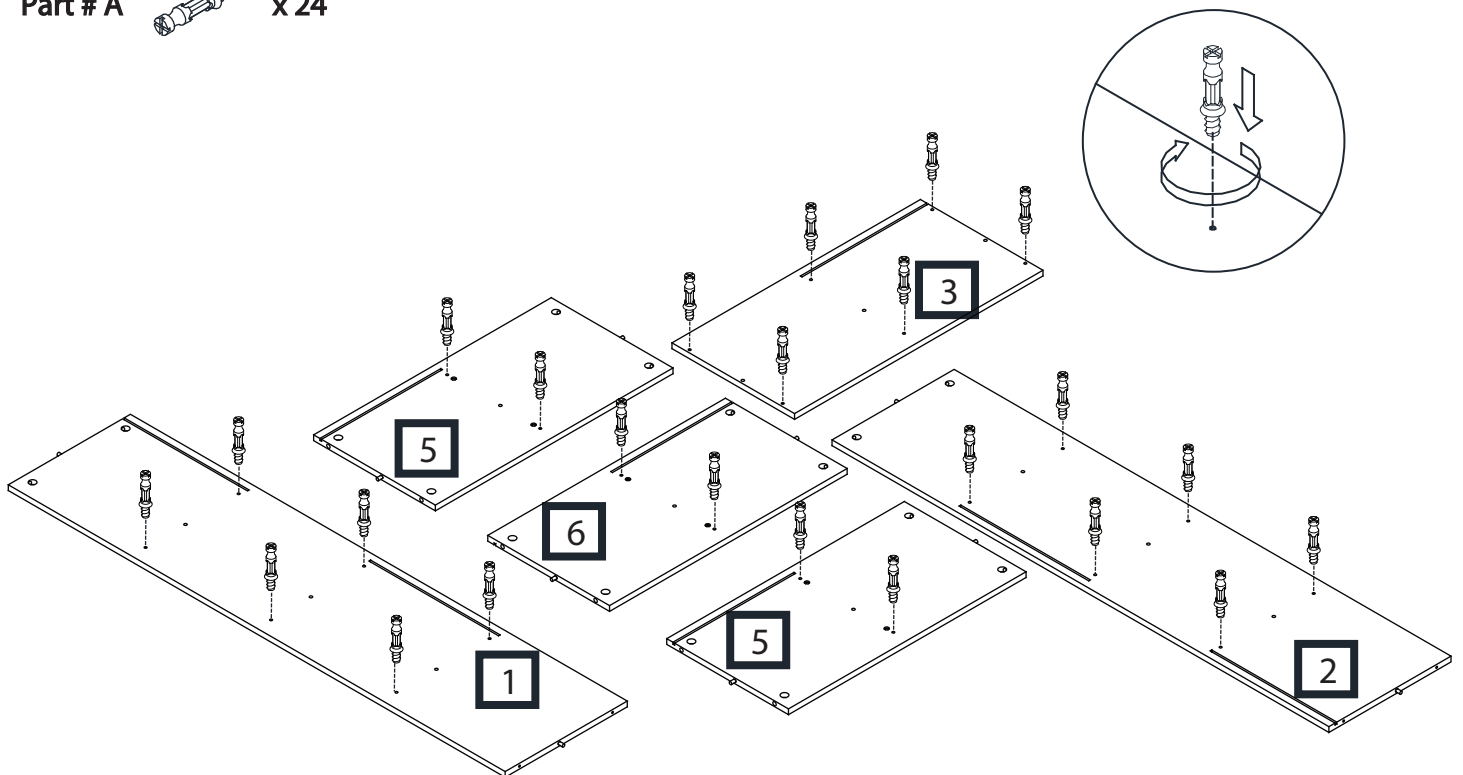

ASSEMBLY INSTRUCTION

Step 3:

Use two CSK Screws (D) to attach Shelf Panel A (5) and Center Panel A (7). Make sure that the grooves for the Back Panel are aligned. (These grooves are on the sides not shown in the drawing below).

Part # D  x 2pcs

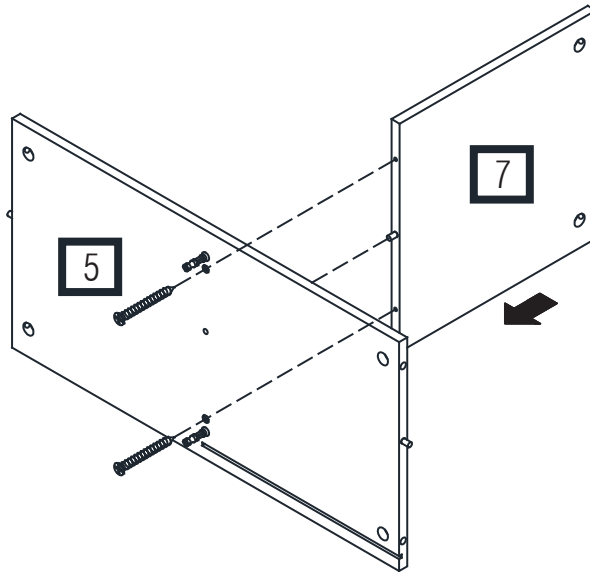

Step 4:

Insert the Minifix Cams (B) into the Center Panel (8). Attach the Center Panel (8) to Shelf Panel A (5). While doing this make sure that the grooves for the Back Panel are aligned. Tighten the two Minifix Cams (B) clockwise and then cover them with Cam Caps (E).

Part # B  x 2pcs

Part # E  x 2pcs

Caution :
Do not over tighten

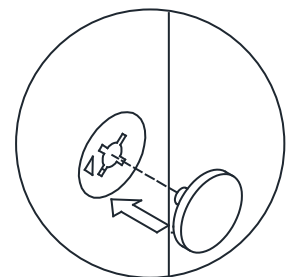
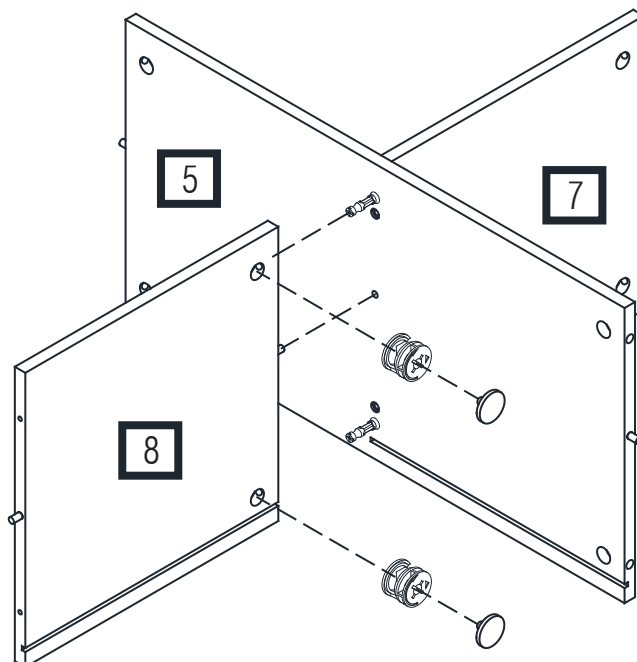
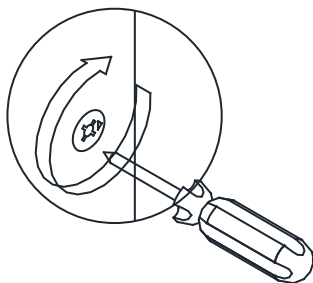

ASSEMBLY INSTRUCTION

Step 5:

Use two CSK Screws (D) to attach the Shelf Panel B (6) and Center Panel B (8). Make sure that the grooves for the Back Panel are aligned.

Part # D  x 2pcs

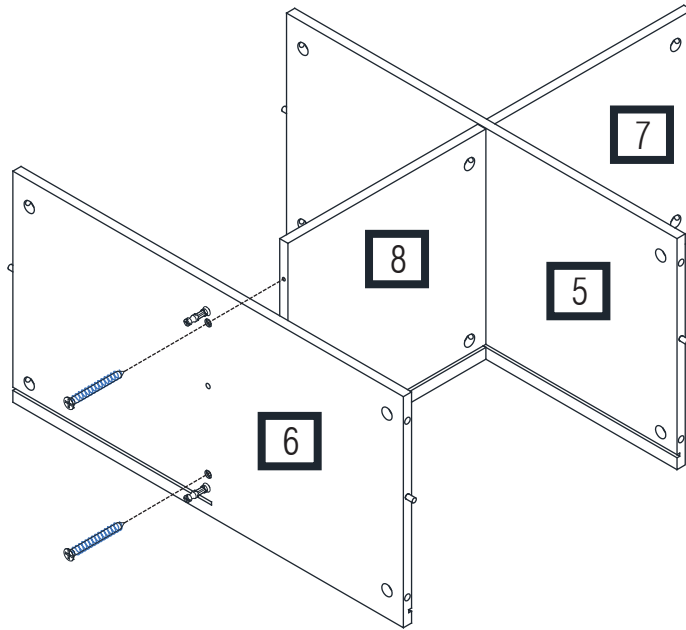

Step 6:

Insert the Minifix Cams (B) into Center Panel A (7). Attach Center Panel A (7) to Shelf Panel B (6). While doing this make sure that the grooves for the Back Panel are aligned. Tighten the two Minifix Cams (B) clockwise and then cover them with Cam Caps (E).

Part # B  x 2pcs

Part # E  x 2pcs

Caution :
Do not over tighten

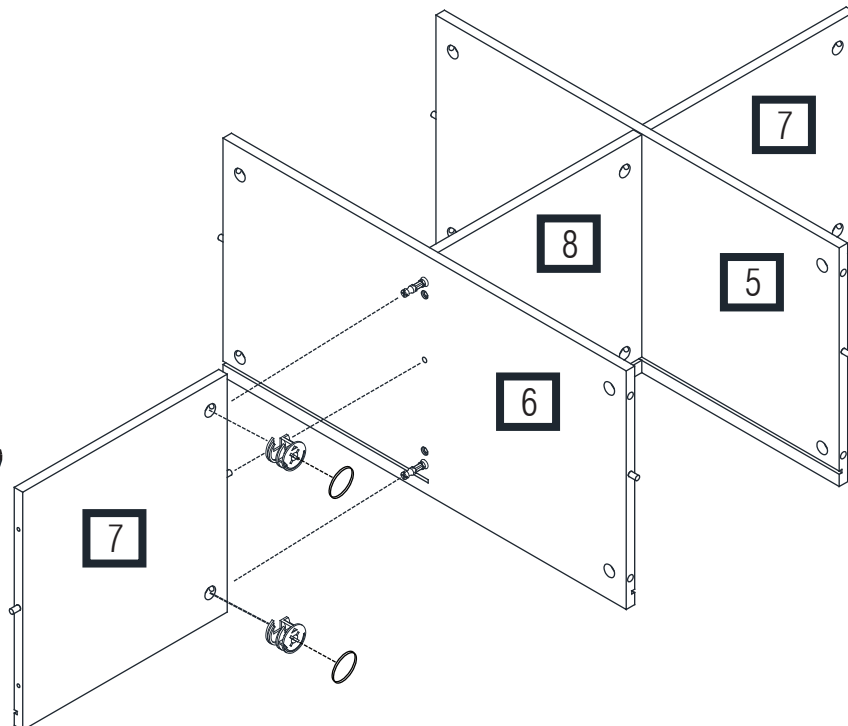
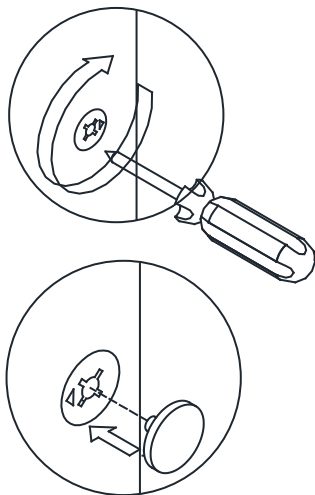

ASSEMBLY INSTRUCTION

Step 7:

Use two CSK Screws (D) to attach Shelf Panel A (5) to Center Panel A (7). Make sure that the grooves for the Back Panel are aligned.

Part # D  x 2pcs

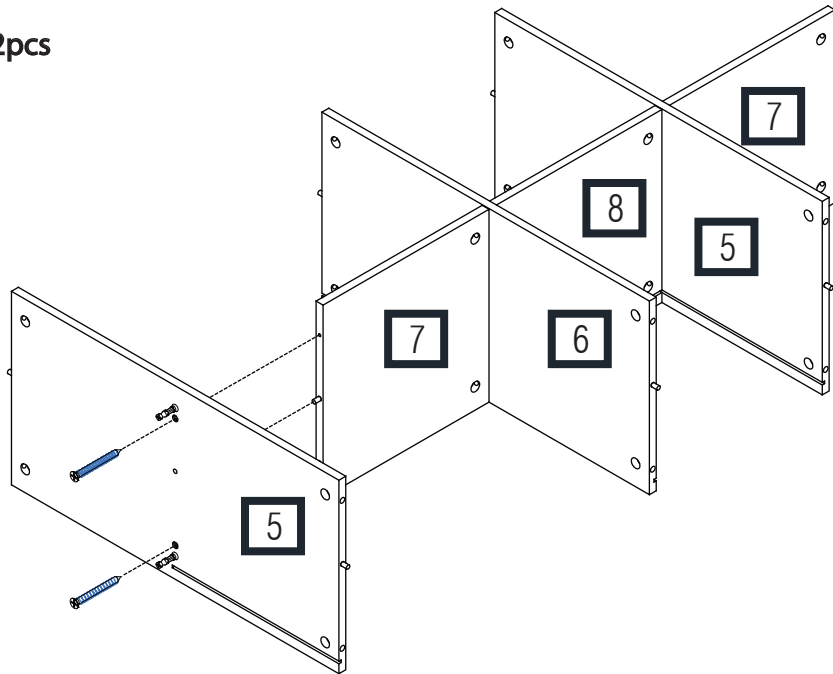

Step 8:

Insert the Minifix Cams (B) into Center Panel B (8). Attach Center Panel B (8) to Shelf Panel A (5). While doing this make sure that the grooves for the Back Panel are aligned. Tighten the two Minifix Cams (B) clockwise and then cover them with Cam Caps (E).

Part # B  x 2pcs

Part # E  x 2pcs

Caution :
Do not over tighten

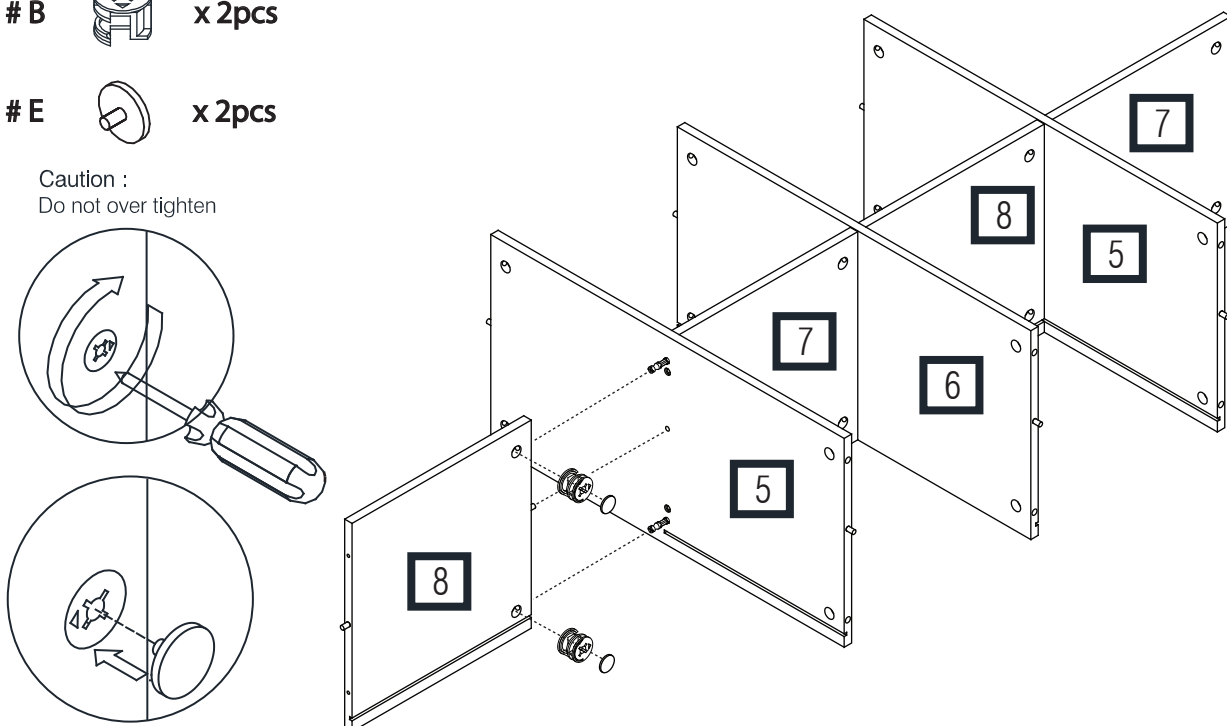

ASSEMBLY INSTRUCTION

Step 9:

Slide in one Back Panel (9) with the finished side facing inside the cube.

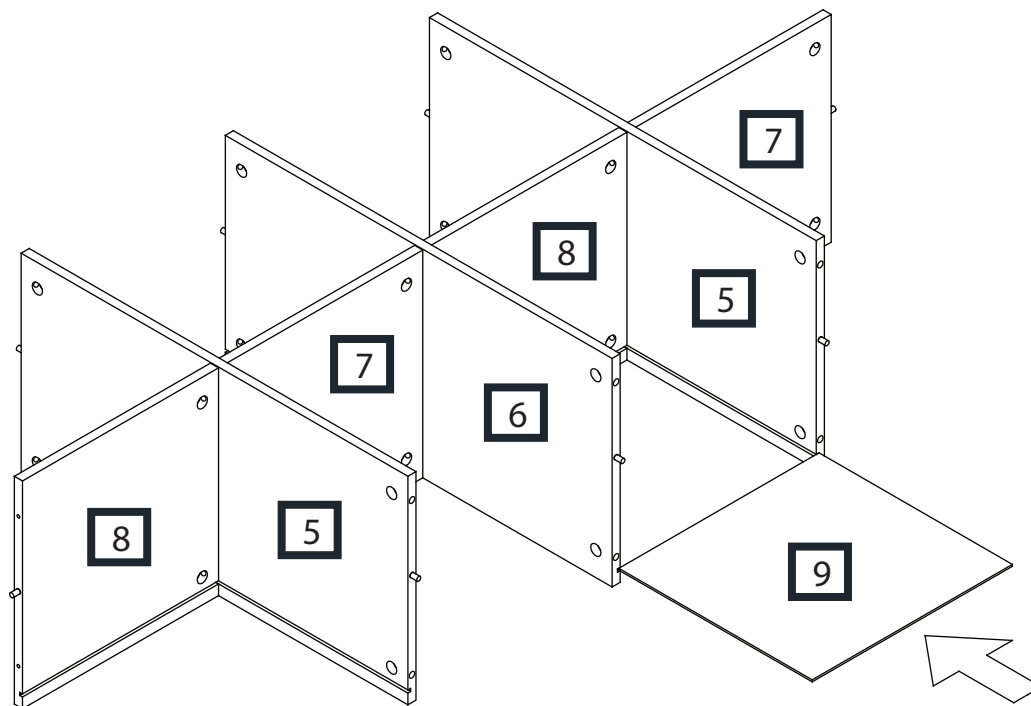

Step 10:

Insert the Minifix Cams (B) into Shelf Panel A (5) and Shelf Panel B (6). Attach Side Panel Right (2) to both Shelf Panels A (5) and Shelf Panel B (6). While doing this make sure that the groove in Side Panel Right (2) is aligned with the panel which you have just inserted. Tighten the six Minifix Cams (B) clockwise and then cover them with Cam Caps (E).

Part # B  x 6pcs

Part # E  x 6pcs

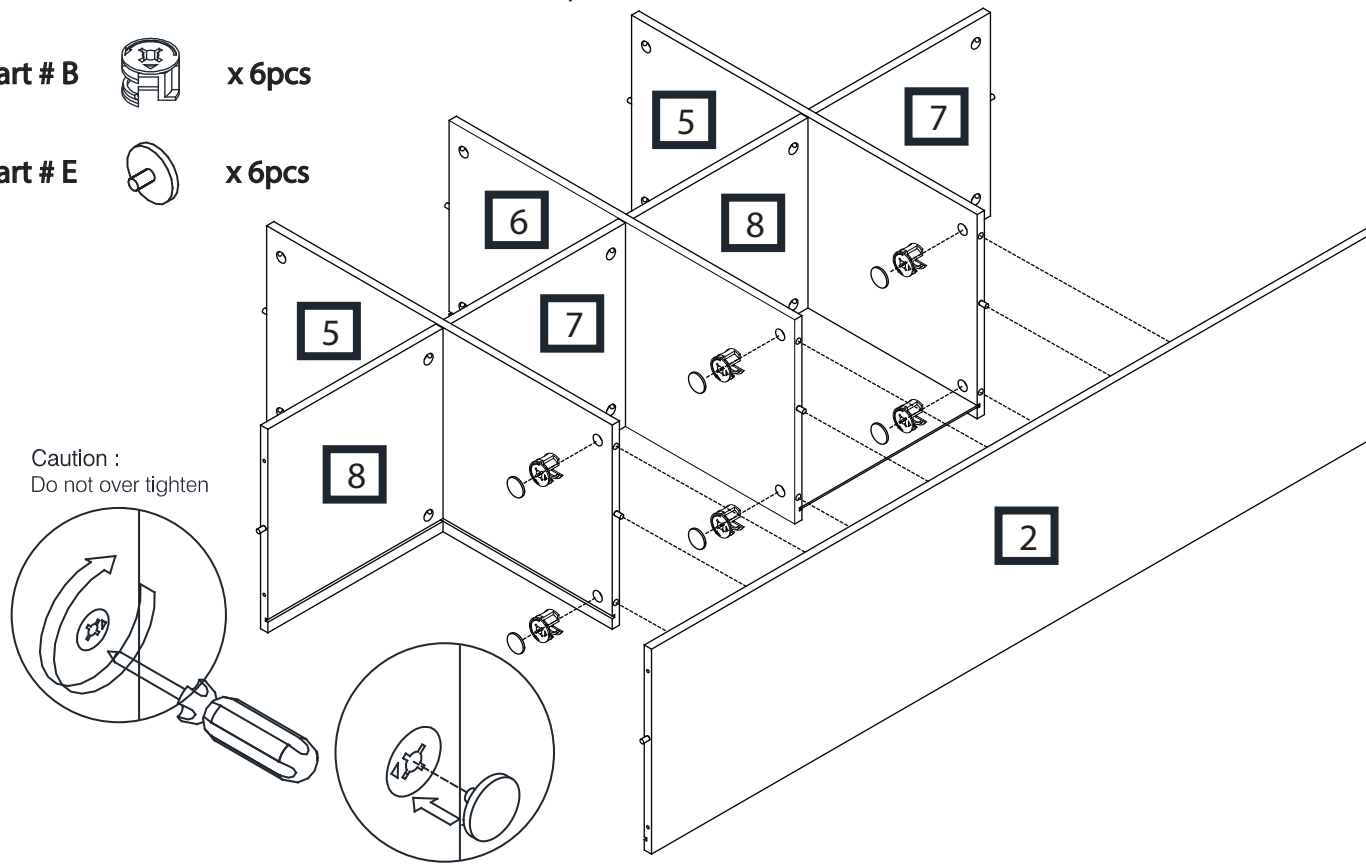

ASSEMBLY INSTRUCTION

Step 11:

Slide in one Back Panel (9) with the finished side facing inside the cube.

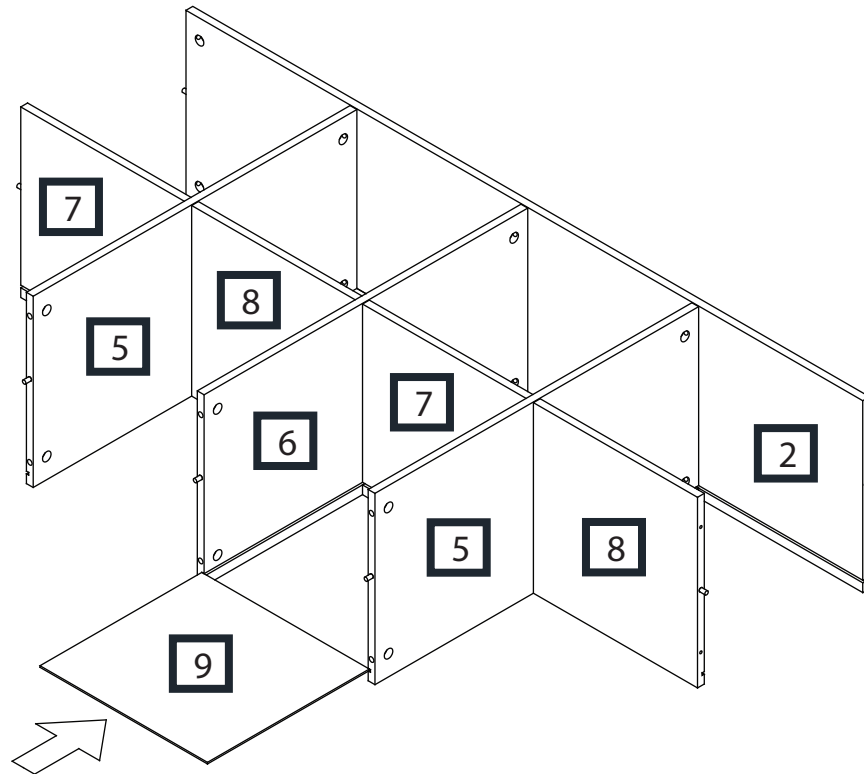

Step 12:

Insert the Minifix Cams (B) into Shelf Panel A (5) and Shelf Panel B (6). Attach Side Panel Left (1) to both Shelf Panels A (5) and Shelf Panel B (6). While doing this make sure that the groove in Side Panel Left (1) is aligned with the panel which you have just inserted. Tighten the six Minifix Cams (B) clockwise and then cover them with Cam Caps (E).

Part # B  x 6pcs

Part # E  x 6pcs

Caution :
Do not over tighten

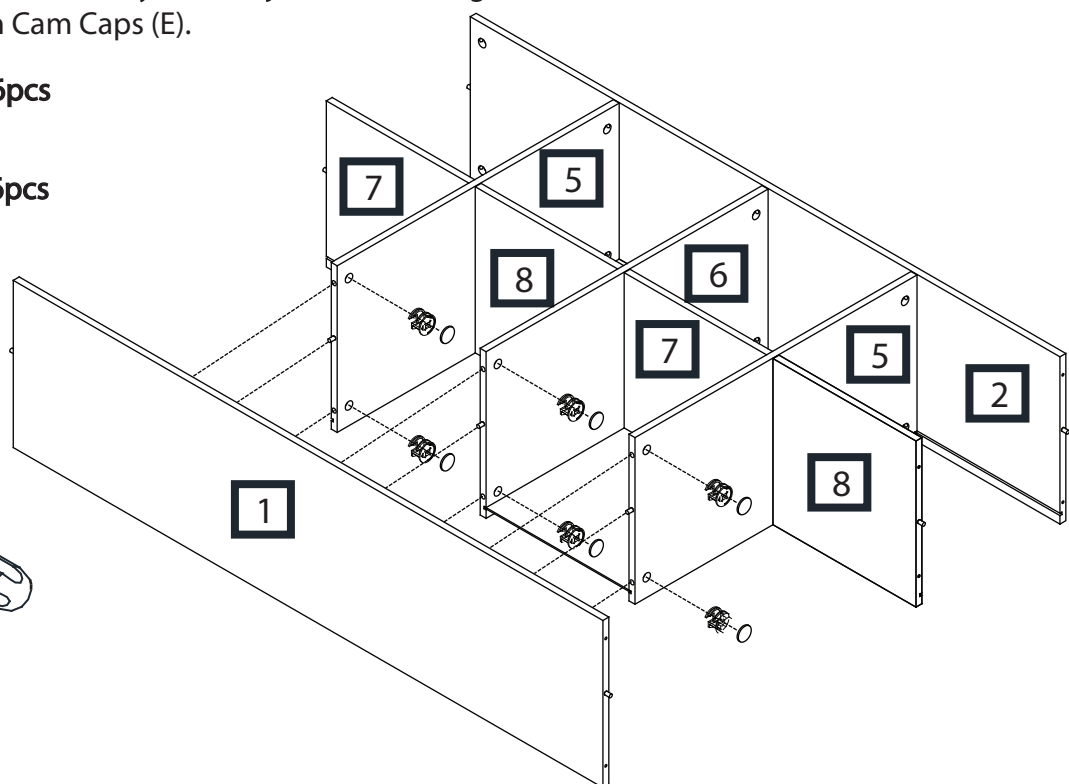
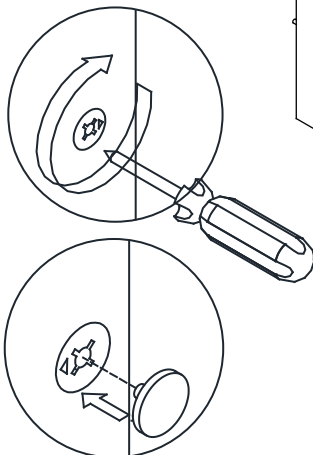

ASSEMBLY INSTRUCTION

Step 13:

Slide in one Back Panel (9) with the finished side facing inside the cube.

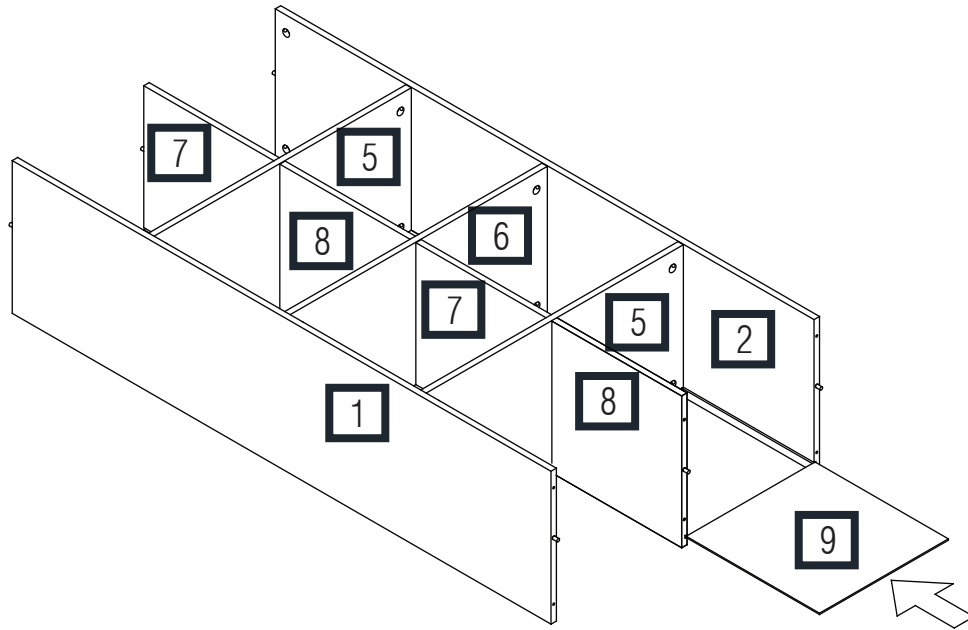

Step 14:

Use six CSK Screws (D) to attach the Bottom Panel (4) to Side Panel Left (1), Side Panel Right (2) and Center Panel B (8). Make sure that the groove in the Bottom Panel (4) is aligned with the panel which you have just inserted.

Part # D  x 6pcs

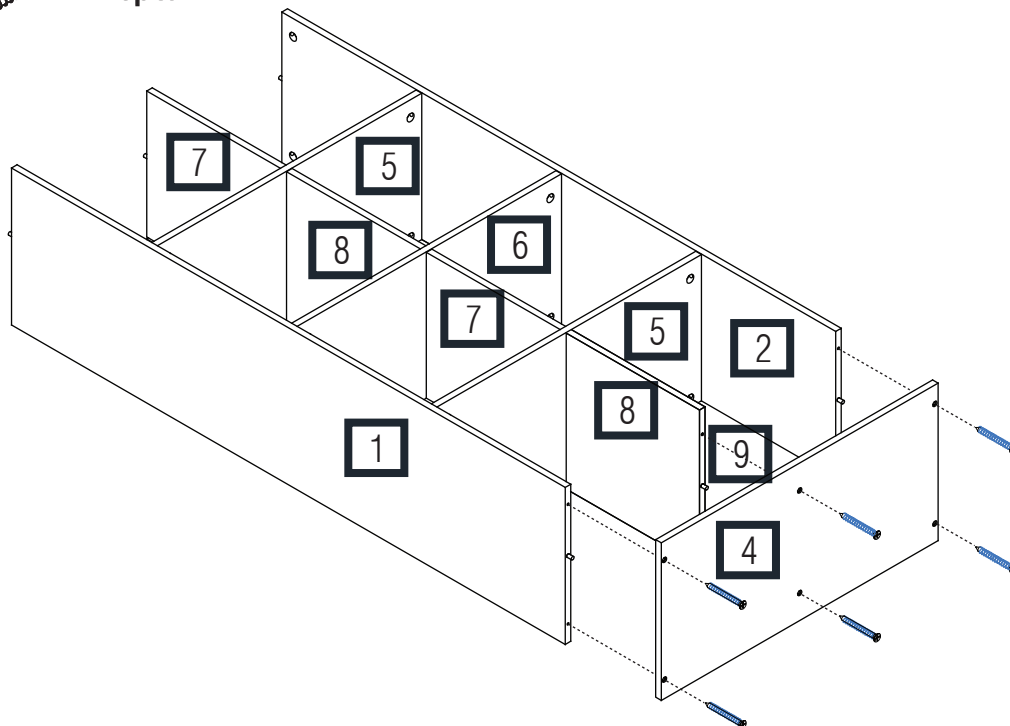

ASSEMBLY INSTRUCTION

Step 15:

Slide in the last Back Panel (9) with the finished side facing inside the cube.

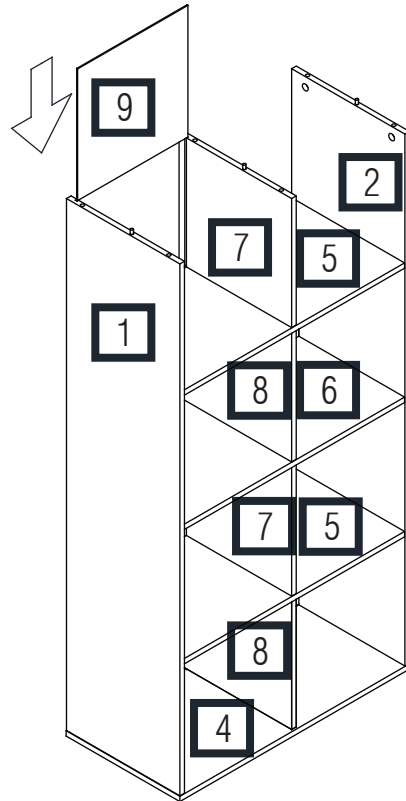

Step 16:

Insert the Minifix Cams (B) into Side Panel Left (1) Side Panel Right (2) and Center Panel A (7). Attach the Top Panel (3) to the Side Panel Left (1), Side Panel Right (2) and Center Panel A (7). Make sure that the groove is aligned with the panel which you have just inserted. Tighten the six Minifix Cams (B) clockwise and then cover them with Cam Caps (E).

Part # B  x 6pcs

Part # E  x 6pcs

Caution :
Do not over tighten

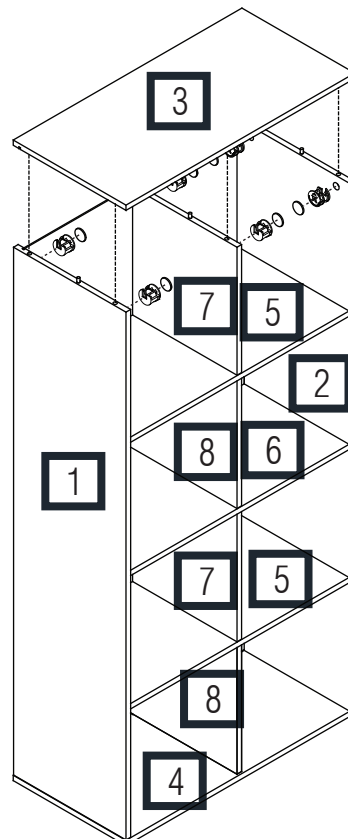
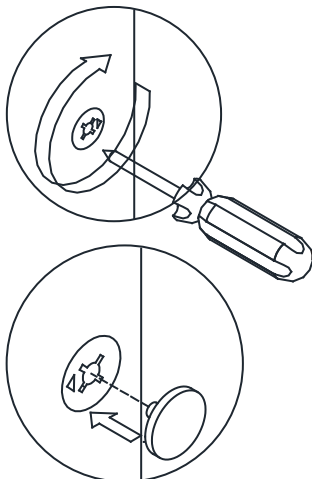

ASSEMBLY INSTRUCTION

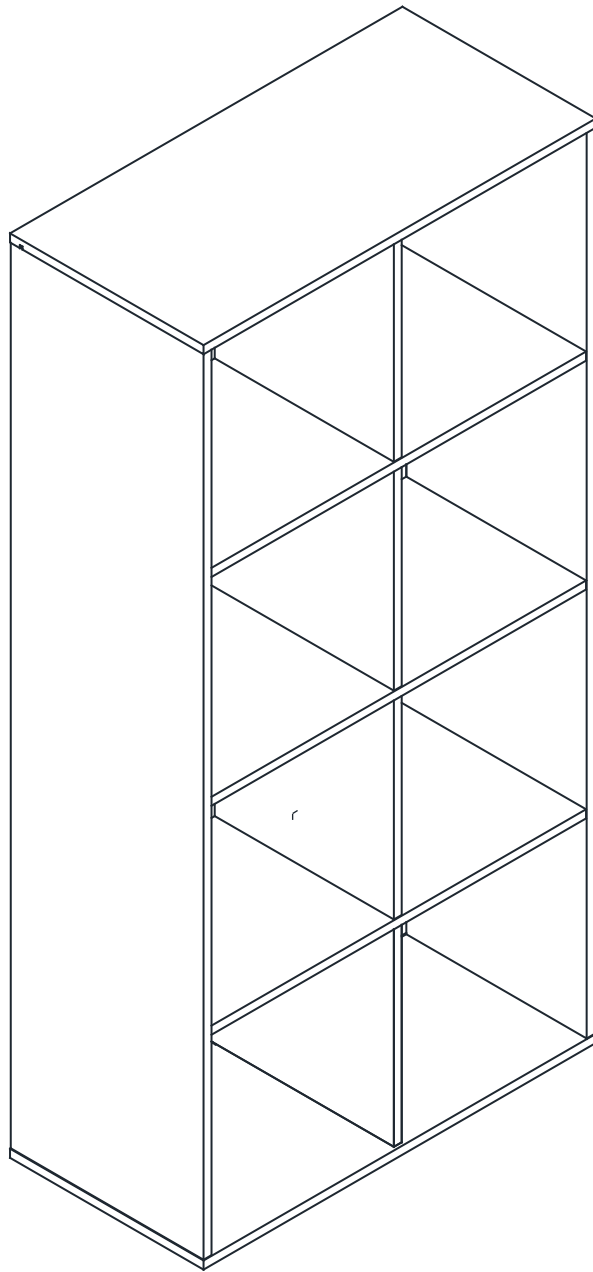

SAFETY AND MAINTENANCE

- DO NOT stand on the desk. Do not use the desk as a stepladder.
- DO NOT use the desk unless all bolts and screws are firmly secured.
- Every 6 months, check all bolts and screws to ensure they are tight.
- This product is California 93120 Compliant for Formaldehyde.

LIMITED WARRANTY

PLEASE VISIT WWW.COMFORTPRODUCTS.NET FOR WARRANTY INFORMATION

Comfort Products warrants this product to be free from defects in material and workmanship for one (1) year. This warranty is made by Comfort Products only to the original end-user customer acquiring the product directly from Comfort Products' authorized dealers as shown by the original sales receipt. The end-user customer remedy pursuant to this warranty is limited to repair or replacement of parts at Comfort Products' option within a reasonable amount of time. Comfort Products reserves the right to require damaged parts to be returned to Comfort Products upon request. Consent from Comfort Products must be obtained before any warranty work is performed. This warranty applies under conditions of normal use and is not subject to defects caused by improper assembly or disassembly; defects occurring after purchase due to product modification, intentional damage, fire, misuse, negligence, or exposure to the elements; labor or assembly cost. This warranty does not cover the cost of transportation or labor. In no event shall Comfort Products be liable in either tort or contract for any loss or direct, special, incidental, consequential or exemplary damages. This Limited Warranty is NOT applicable to end-user customers who use Comfort Products for rental purposes. This warranty applies only to end-user customers in the United States. All warranties are limited to the original purchaser for normal use. The weight capacity is defined as 10 pounds for the shelves and 40 pounds for the top panel. For claims or questions concerning this warranty, please visit: www.comfortproducts.net or email us at: customerservice@comfortproducts.net
MODEL: # 50-812ES

Comfort Products, Inc.

P.O. Box 999

Memphis, TN 38101

www.comfortproducts.net

customerservice@comfortproducts.net



OneSpace™

OneSpace is a Trademark of Comfort Products, Inc.