

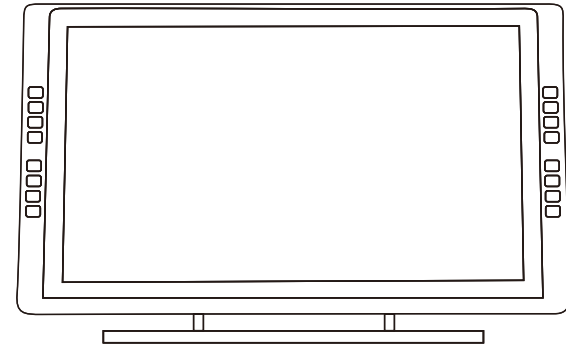

# Graphic Pen Display

## Artist 22E Manual

Windows 10,8,7 and Vista Mac 10.7 or above



Web site: [www.xp-pen.com](http://www.xp-pen.com)  
Mail: [service@xp-pen.com](mailto:service@xp-pen.com)

Please contact us with any questions



Designed by XPPEN Technology CO. in California, Assembled in China

[www.xp-pen.com](http://www.xp-pen.com)

# Contents

<b>I. Overview</b> .....	1
a. System Requirements .....	1
b. Product Overview .....	1
c. Stylus Overview .....	2
d. Pen Tip Replacement .....	3
<b>II. Setting up the Artist 22E</b> .....	3
<b>III. Driver Installation</b> .....	4
a. Windows .....	5
b. Mac .....	7
<b>IV. Driver Settings UI</b> .....	9
a. Windows .....	9
b. Mac .....	20
<b>V. FAQ</b> .....	26

# {I.Overview}

## SYSTEM REQUIREMENTS

- Windows 10/8/7
- Mac OSX 10.7 / 10.8 / 10.9 or later
- USB and HDMI port
- CD/DVD-ROM drive or an internet connection

The Artist 22E is designed to allow artists to draw and paint digitally with the same ease as with traditional tools. Users draw directly on the tablet's display with our rechargeable stylus, which simulates the feel of working with a pencil, pen, or paintbrush on paper. 2048 pressure levels along with our hands-on design allow you to draw and paint naturally—with all the advantages offered by a digital medium!

## PRODUCT OVERVIEW



Image 1-1: Overview

- (1). Display/Working area
- (2). Express keys
- (3). Power indicator light
  - a. On, blue: The Artist 22E is connected to your computer and powered on.
  - b. On, red: The Artist 22E is powered on, but not connected to a computer.
  - c. Off: The Artist 22E is powered off.
- (4). Power button
- (5). Menu button
- (6). + button
- (7). - button

- (8). Display auto adjust button
- (9). USB port
- (10). Power jack
- (11). HDMI port
- (12). DVI port
- (13). VGA port
- (14). Stand adjustment lever
- (15). Stand

## Artist 22E box contents:

- (1). Artist 22E graphic tablet monitor
- (2). 2 Styluses
- (3). HDMI cable
- (4). VGA cable
- (5). USB cable
- (6). USB stylus charger
- (7). Power adapter
- (8). Power cord
- (9). Driver CD
- (10). User manual

## STYLUS OVERVIEW

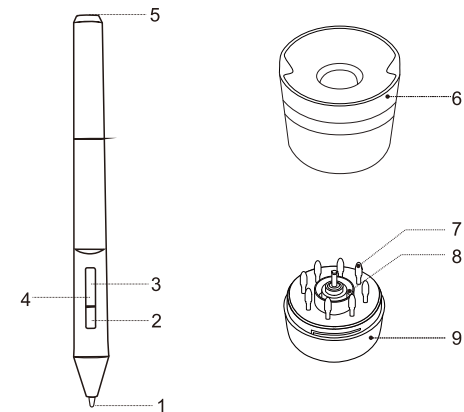

Image 1-2: Stylus overview

- (1). Pen tip
- (2). Barrel button 2
- (3). Barrel button 1
- (4). Power indicator
  - a. On, red: Low battery.
  - b. On, blue: Battery is charging.
  - c. Off: Battery is fully charged.
- (5). Charger port
- (6). Pen stand (Upper)
- (7). Spare pen tips
- (8). Pen clip
- (9). Pen stand (Lower)

**Note:**

After being idle for 20 minutes, the Artist 22E’s stylus will go into power saver mode. To “wake up” the stylus, tap it against your tablet display.

**PEN TIP REPLACEMENT**

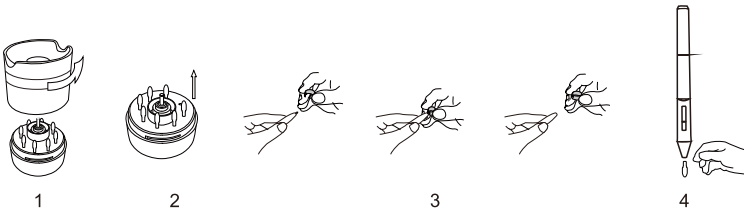

Image 1-3: Pen tip replacement

- (1). Hold the upper half of the pen stand and twist counterclockwise to remove it.
- (2). Remove the pen clip located in the center of the lower pen stand.
- (3). Use the pen clip to grip the pen tip and pull it out of the stylus.
- (4). Push the new pen tip into the stylus.

**{II.Setting up the Artist 22E}**

1. Connect the Artist 22E to your computer via the included USB cord.
2. Connect the Artist 22E’s power cord. Plug the cord into the included adapter, then into a wall outlet.
3. Connect the Artist 22E to your computer via the included HDMI cord.



Image 2-1: Connection (1:USB port; 2 :Power jack; 3 :HDMI port)

**Note:**

If your tablet displays a “No Signal” error message:

- (a). Unplug the Artist 22E’s HDMI/VGA and power cords, then plug them back in. Ensure that each cord is connected well. Reboot your computer.
- (b). Test the Artist 22E on a different computer to check for hardware issues.
- (c). If the error persists on different computers and (a) does not solve it, contact XP-Pen support.

**{III.Driver Installation}**

**Notes:**

- (a). Disable any antivirus or firewall software before beginning the installation.
- (b). Uninstall any existing tablet software before attempting to install the Artist 22E driver. Other tablet drivers will conflict with the Artist 22E driver or prevent installation entirely.
- (c). You may install the Artist 22E driver with the included CD or download the latest driver version from the XP-Pen website ([www.xp-pen.com](http://www.xp-pen.com) ). If you choose to download the driver from the website, be sure to extract the . zip file contents before running install.exe.
- (d). The Artist 22E’s maximum resolution is 1920x1080.

- (1). Connect the Artist 22E to your computer using the included HDMI, USB & Power cords. Turn on the tablet.
- (2). Insert the included driver CD into your computer's CD/DVD drive and follow the on-screen instructions. If setup does not begin automatically, open the disc contents manually and run setup.exe or install.exe.
- (3). After the installation has completed, reboot your computer.
- (4). After a successful installation, the driver's icon (  ) will appear in your system tray. If the icon is not present; uninstall the driver, reboot, and repeat step 2.
- (5). (Recommended) Open [Control Panel] > [Display], then set Change the size of text, apps, and other items to 100%

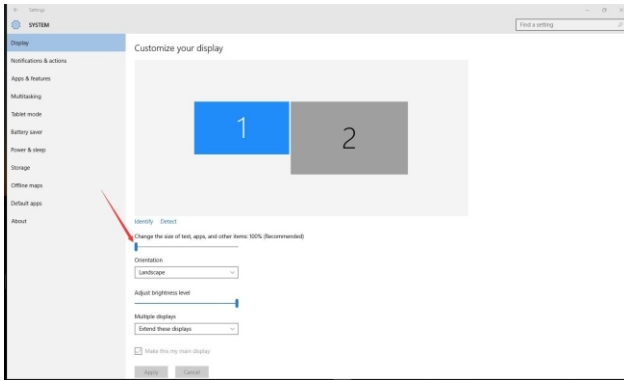

Image 3-1: Display settings

- (6). In [Control Panel] > [Display], change your dual monitor settings to Extend these displays or Duplicate these displays.
- (7). In Extend these displays mode, set your Artist 22E's resolution to 1920x1080.
- (8). In Duplicate these displays mode, set both of your monitors' resolutions to 1920x1080.

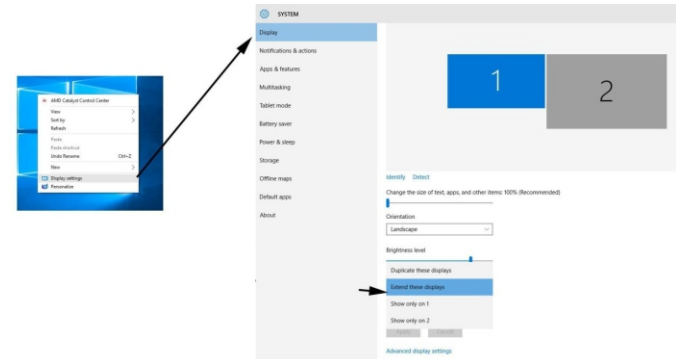

Image 3-2: Extend mode

- (9). Apply and exit.
- (10). **In Extend mode:** Click the driver's system tray icon to open your tablet settings. Set your Artist 22E to Monitor 2 in the Monitor Setting tab. Apply and exit.

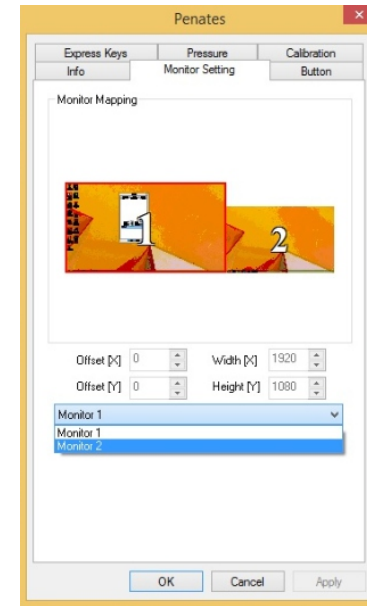

Image 3-3: Monitor Setting

- (1). Connect the Artist 22E to your computer using the included HDMI, USB & Power cords. Turn on the tablet.
- (2). Insert the included driver CD into your computer's CD/DVD drive.
- (3). Open the CD's file list. Open the Mac Driver folder, then run PenTablet.pkg.
- (4). Follow the on-screen instructions, then reboot your computer.

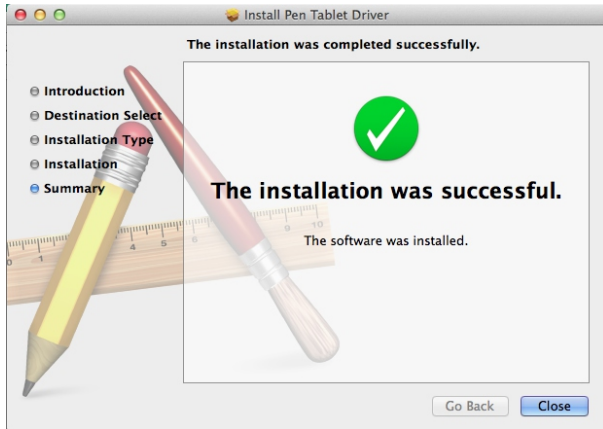

Image 3-4: Mac installation

- (5). Open [System Preferences] > [Display]. In the Display tab, set your resolution to Default for display.

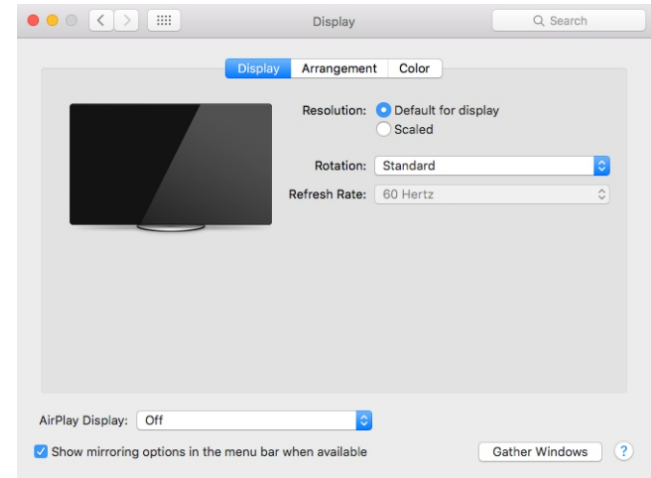

Image 3-5: Display settings

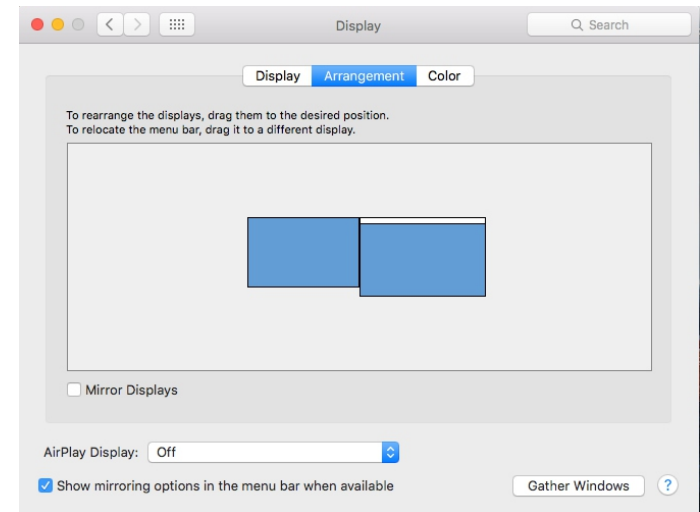

Image 3-6: Arrangement settings

- (6). In the Arrangement tab, you may choose to Mirror Displays. With Mirror Displays enabled, both monitors' resolutions should be set to 1920x1080.
  - (6.1) Open [Finder] > [Applications] > [Touch Tablet] > [Pen Tablet Setting].
  - (6.2) In the Calibration tab, set Monitor Mapping to Full Monitor.
- (7). With Mirror Displays disabled, set your Artist 22E's resolution to 1920x1080.
  - (7.1) Open [Finder] > [Applications] > [Touch Tablet] > [Pen Tablet Setting].
  - (7.2) In the Calibration tab, set Monitor Mapping to Monitor 2.

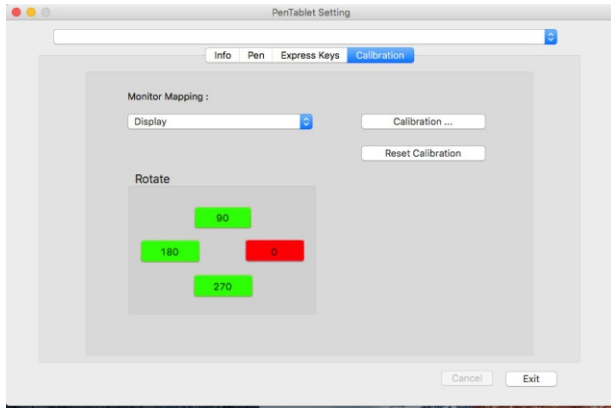

Image 3-7: Monitor mapping

## {IV.Driver Settings UI}

### WINDOWS

To open the Artist 22E's driver settings:

- (1). Open [Start] > [Settings] > [Control Panel] > [TabletSetting].

OR

- (2). Double-click the Artist 22E system tray icon (  ).

### INFO

The Info tab displays the current downloaded driver version.

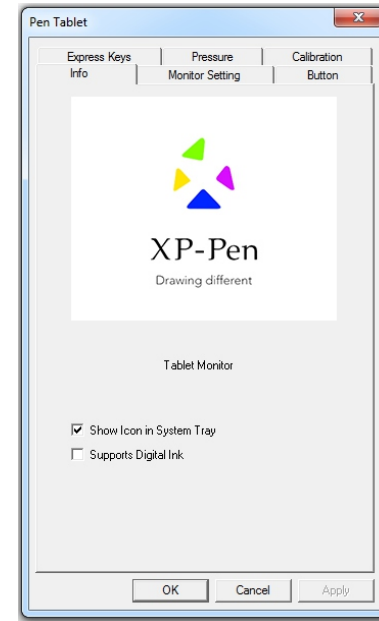

Image 4-1: Info

Digital Ink and the Artist 22E's system tray icon can be toggled on and off here. Digital Ink affects pen pressure in various Microsoft software, such as Word and OneNote.

### MONITOR SETTING

This tab displays the active monitor currently selected for your tablet. Generally, this should be set to Monitor 2.

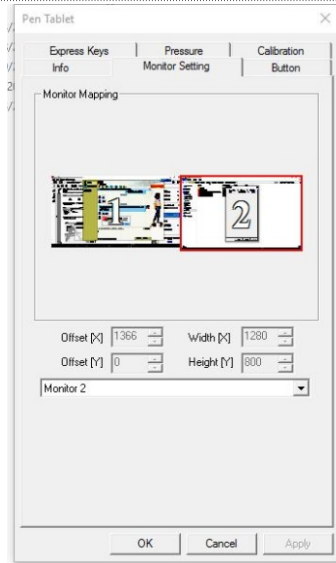

Image 4-2: Monitor Setting

Select Full Monitor here when working with mirrored displays.

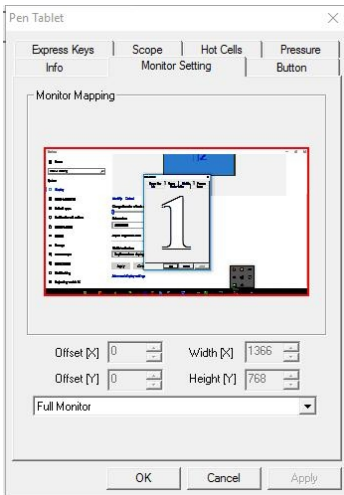

Image 4-3: Full Monitor

## BUTTON

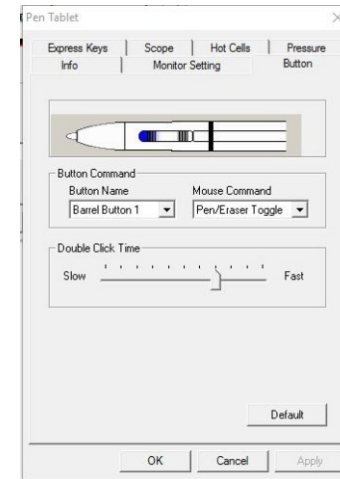

Image 4-4: Button

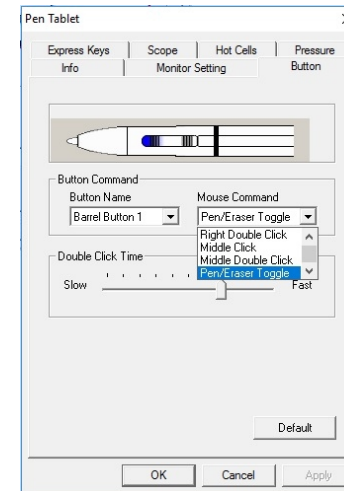

Image 4-5: Pen/Eraser Toggle

You may customize the functions of the pen stylus's barrel buttons in this tab. All standard mouse functions are available. Click Default to revert to manufacturer settings.

Double Click Time adjusts the quickness required between pen taps to register as a double-click.

**Note:**

**Pen/Eraser Toggle**

With the stylus in range of the Artist 22E's working area, press the assigned barrel button (Button 1 by default) to toggle between pen and eraser modes in compatible drawing software. The current mode will be briefly displayed on your monitor.

**EXPRESS KEYS**

**Notes:**

(a). The Artist 22E's express keys are designed to work with US English keyboards. Keys may not function correctly with other keyboard languages.

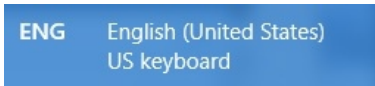

(b). By default, the Artist 22E's express keys are mapped to standard Photoshop keyboard shortcuts. Keys can be customized to function efficiently in other software.



Image 4-6: Express Keys

The Artist 22E's shortcut keys can be customized in this tab. Click Default to revert to manufacturer settings.

After clicking a shortcut key, you will be shown several tabs that may be edited.

**a.Common**

The Common tab allows you to rename or disable a key.

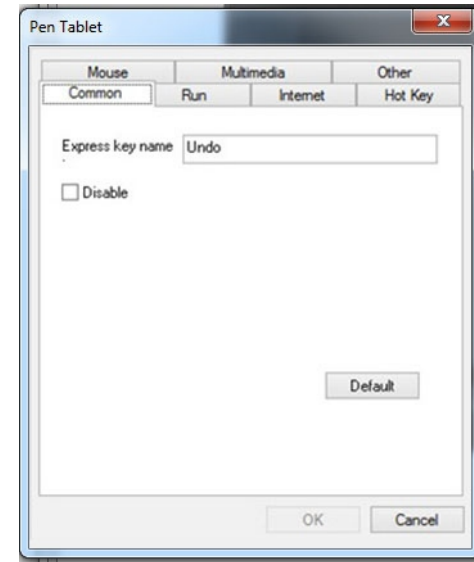

Image 4-7: Common

**b.Mouse**

The Mouse tab allows you to bind a key to a standard mouse function.

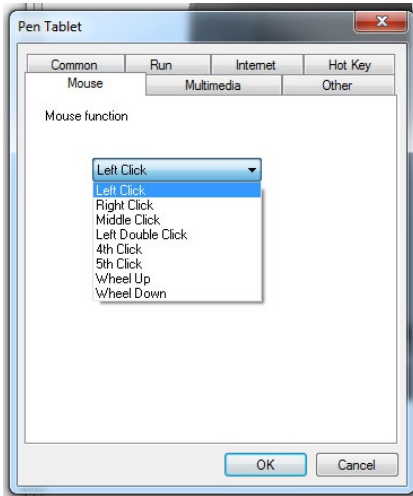

Image 4-8: Mouse

### c.Multimedia

The Multimedia tab allows you to bind a key to a common media function, such as play/pause.

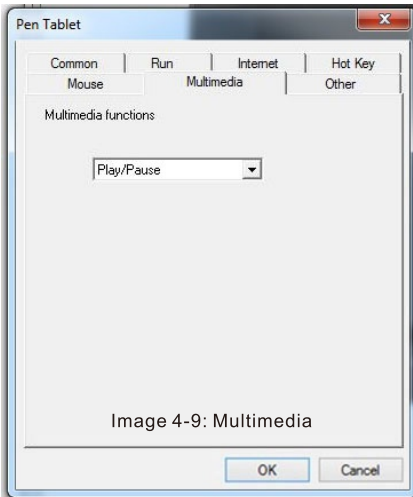

Image 4-9: Multimedia

### d.Other

The Other tab allows you to program a key to change the on-screen working area, to show settings, or to function as a pen/eraser toggle.

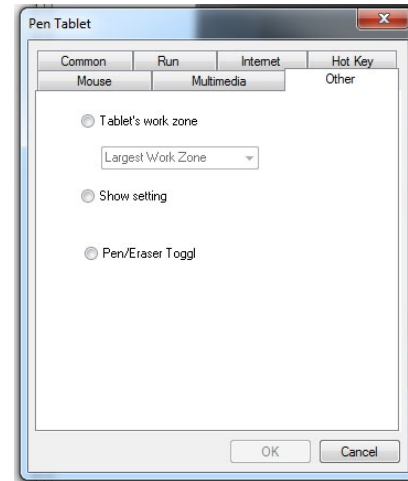

Image 4-10: Other

### e.Run

The Run tab allows you to program a key to open a specified program or document.

**Start in:** This is the folder from which the chosen program executes.

**Parameters:** This will be passed to the program as parameters. For example, you may type a document name here to open it in a word processing program specified in the Run field.

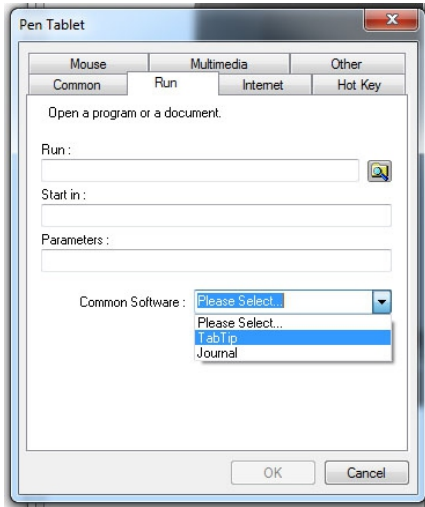

Image 4-11: Run

### f. Internet

Network Function allows a key to be programmed to execute a common web browsing command, such as back, forward, or refresh. Link To allows a key to be programmed to open a specific website or begin an e-mail.

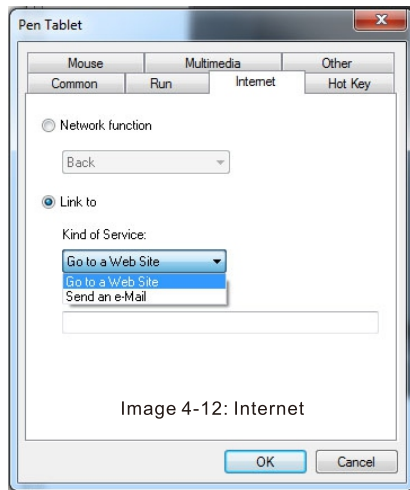

Image 4-12: Internet

### g. Hot Key

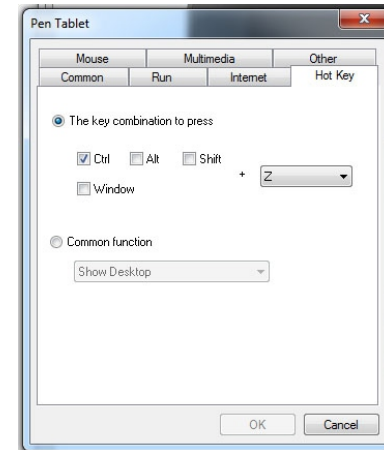

Image 4-13: Hot Key

In the Hot Key tab, a key may be programmed to execute a specified keystroke or a common function from a list.

#### Common functions:

**Show Desktop:** Displays the desktop.

**Switch Application:** Toggles among open windows. Only functions on systems that support this feature.

**3D Switch Application (Win 7/Vista):** Activates the Windows Flip 3D function to quickly preview all open windows. Only functions on systems that support this feature.

**Pop Menu:** Opens a pop-up menu for these frequently used functions:

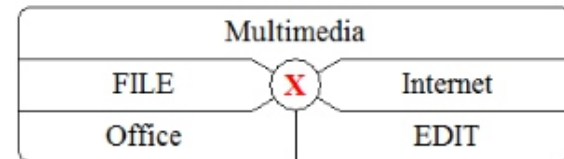

Image 4-14: Multimedia

## PRESSURE

The Pressure tab allows you to test your tablet's pen pressure and adjust its sensitivity. Lighter sensitivity means that digital pressure level will rise with less applied physical pressure.

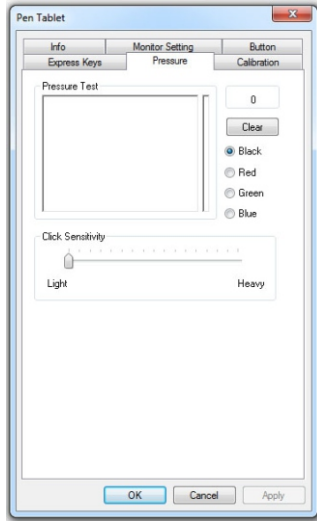

Image 4-15: Pressure

## CALIBRATION

The Calibration tab allows you to set up 4 and 9-point calibration for your tablet.

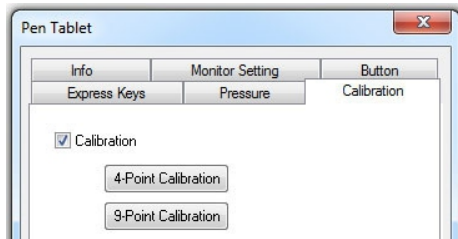

Image 4-16: Calibration

You may also rotate the Artist 22E's display in this tab.

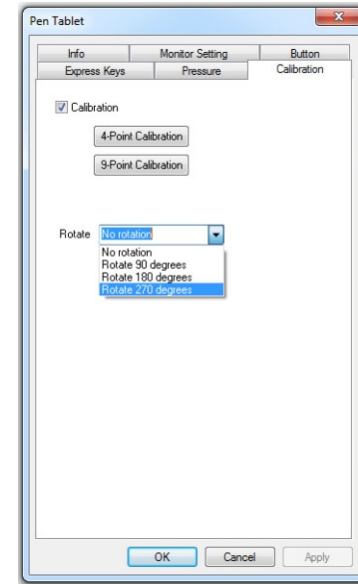

Image 4-17: Rotation

## MAC

To open the Artist 22E's driver settings, open [GO] > [Applications] > [TouchTablet] > [TabletSetting].

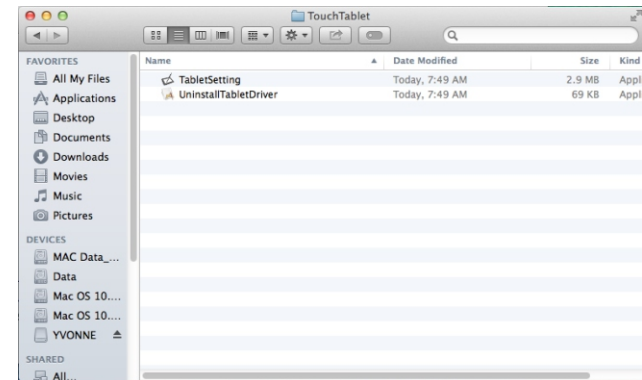

Image 4-18: Tablet Setting

## INFO

The Info tab displays the current downloaded driver version.

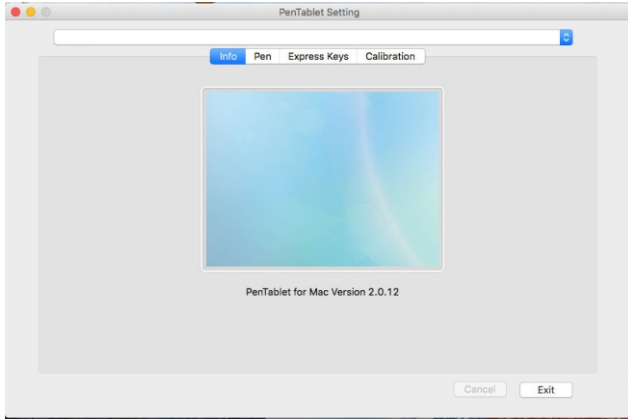

Image 4-19: Info

## PEN

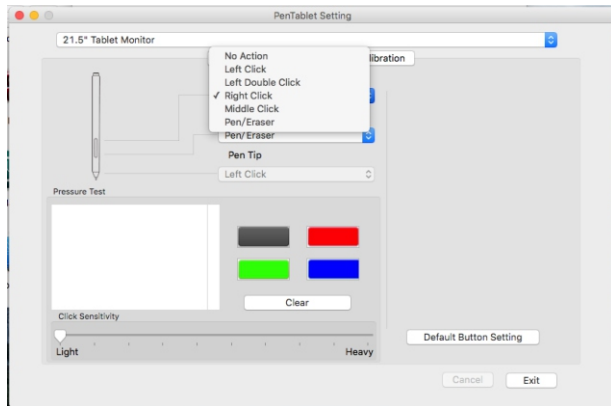

Image 4-20: Pen

You may customize the functions of the pen stylus barrel buttons in this tab. All standard mouse functions are available. Click Default Button Setting to revert to manufacturer settings.

### Note:

#### Pen/Eraser

With the stylus in range of the Artist 22E's working area, press the assigned barrel button (Button 1 by default) to toggle between pen and eraser modes in compatible drawing software. The current mode will be briefly displayed on your monitor.

This tab also allows you to test your tablet's pen pressure and adjust its sensitivity. Lighter sensitivity means that digital pressure level will rise with less applied physical pressure.

## EXPRESS KEYS

### Notes:

- (a). The Artist 22E's express keys are designed to work with US English keyboards. Keys may not function correctly with other keyboard languages.
- (b). By default, the Artist 22E's express keys are mapped to standard Photoshop keyboard shortcuts. Keys can be customized to function efficiently in other software.

The Artist 22E's shortcut keys can be customized in this tab. Click Default to revert to manufacturer settings.

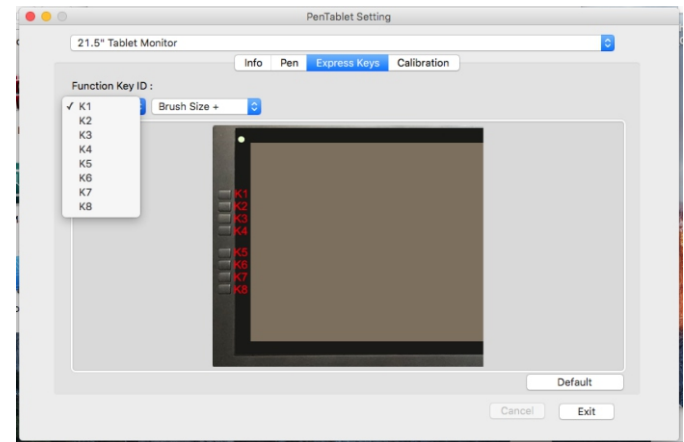

Image 4-21: Express Keys

You may choose a key's function from a preset list, or click Reset Customer Defined for advanced options

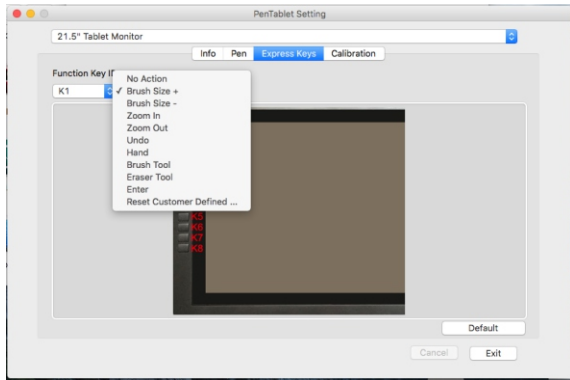

Image 4-22: Express Keys-1

### a.Application

Allows a key to be programmed to open a specified application.

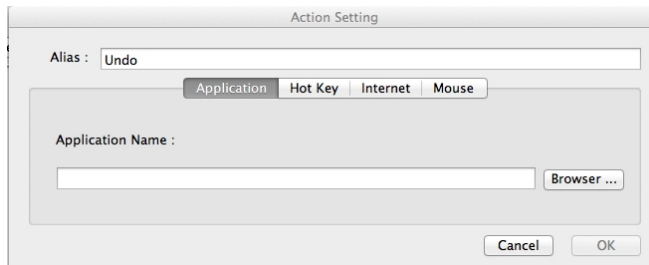

Image 4-23: Application

### b.Hot Key

Allows a key to be programmed to execute a preset or custom keystroke.

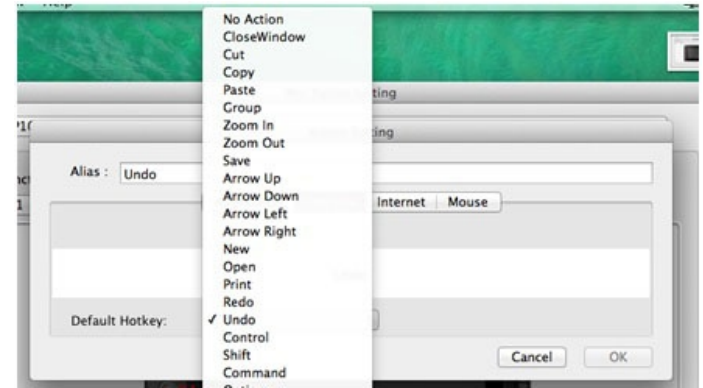

Image 4-24: Hot Key

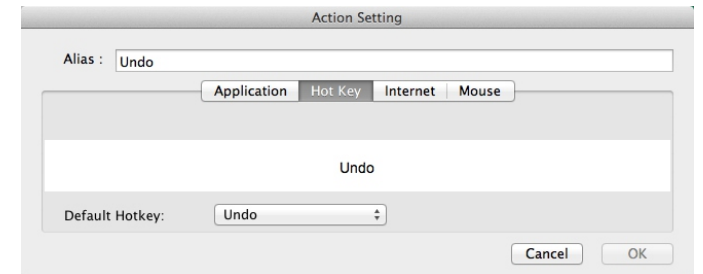

Image 4-25: Hot Key-1

### c.Internet

Allows a key to be programmed to open a specified website or begin an e-mail.

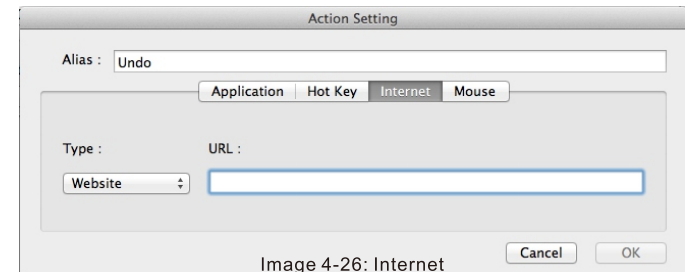

Image 4-26: Internet

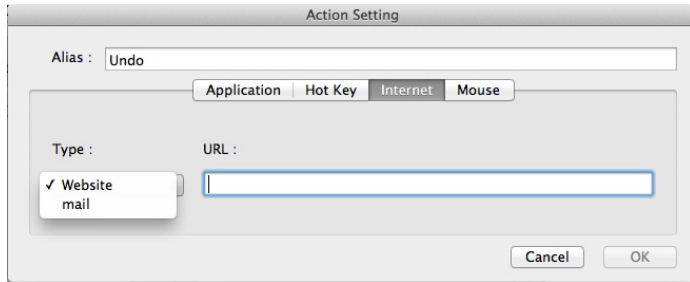

Image 4-27: Internet-1

### d.Mouse

Allows a key to be programmed to execute a common mouse function.

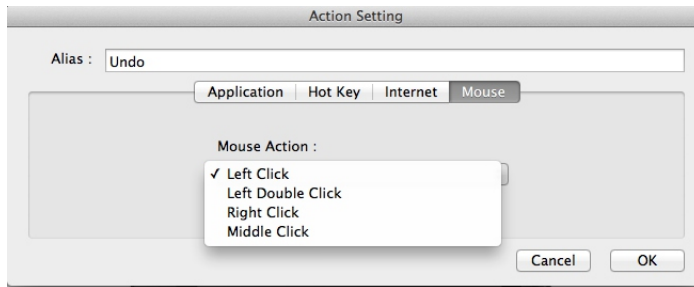

Image 4-28: Mouse

## CALIBRATION

The Calibration tab allows you to calibrate your tablet, map your monitor, or rotate your display.

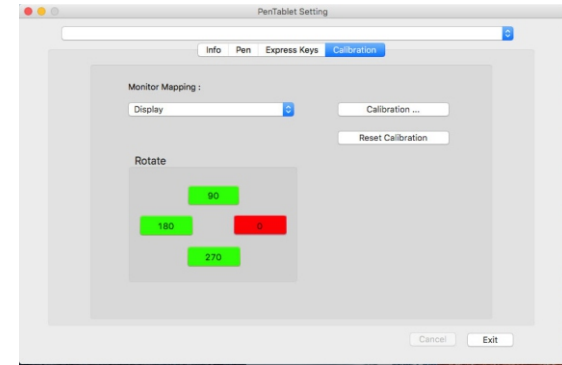

Image 4-29: Calibration

To calibrate, click Calibration ... and follow the on-screen instructions. You may also rotate the Artist 22E's display in this tab.

## {V.FAQ}

**Q: Where can I download the latest Artist 22E driver?**

A: Latest driver releases can be downloaded on the XP-Pen website ([www.xp-pen.com](http://www.xp-pen.com)).

**Q: My Artist 22E isn't working.**

A: Follow these steps:

1. Disconnect the Artist 22E from your computer.
2. Uninstall the Artist 22E driver. Reboot your computer.
3. Reconnect your Artist 22E. Verify that all cords (HDMI/VGA, USB, and power) are connected correctly and securely.
4. Install the latest driver from [www.xp-pen.com](http://www.xp-pen.com). Reboot your computer.
5. The Artist 22E's driver icon  should now be visible in the system tray.
6. If the icon is not visible, you may have a compatibility issue. Open [My Computer] ► [Properties] ► [Hardware] ► [Device Manager]. If an exclamation mark is visible beside the Artist 22E driver, it is incompatible with your operating system. Contact XP-Pen for support.

**Q: My pen pressure doesn't work.**

A: If pen pressure is non-functional in the Pressure/Pen tab in your driver settings, your stylus may be faulty. Contact XP-Pen for support.