

Action Camera



Wide Angle



WIFI



Ultra HD



Waterproof



HDMI

Warning

- 1,Keep it safe from falling and dropping
- 2,Keep it distance from any strong magnetic interference objects like electrical machine to avoid strong radio waves that might be damaging the product and affect the sound or image quality.
- 3,Don't expose the product directly to high temperatures and strong sunlight
- 4,We recommend using high quality Micro SD Card for the best results.
- 5,Don't place your Micro SD card near strong magnetic objects to avoid data error.
- 6,In case of overheating, unwanted smoke or unpleasant smell from the device, unplug it immediately from the power outlet to prevent hazardous fire.
- 7,Keep it safety from children while on charging.

8,Stored the device in a cool, dry and dust free location.

Product features

- With a water proof casing, allowing you to film 30 meters under water scene.
- HD screen display for convenient videos and image playback
- Detachable battery for easy replacement and help extend product lifespan
- Record videos while charging
- HD 16 Megapixel wide angle lens
- HDMI Output
- Web Camera
- Supports SD card memory expandable up to 64GB (Maximum)
- Supports multiple video recording formats:
4K/2K/1080P/720P/ WVGA

- Supports MOV recording format
- Supports multiple photo shooting modes: Single shot & Snapper
- Video encryption enabled
- Super lightweight, small in size and available in 8 colors

Camera Illustration

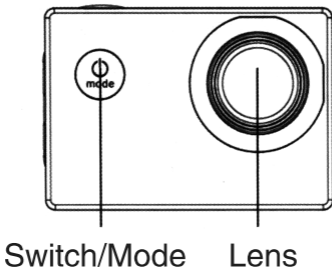

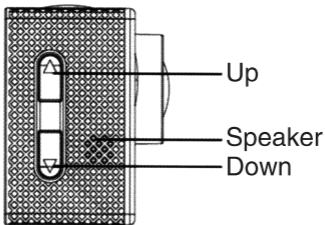
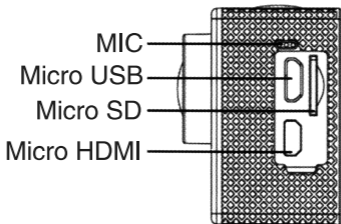

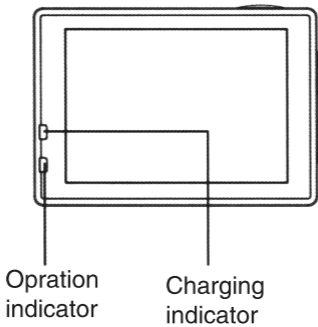
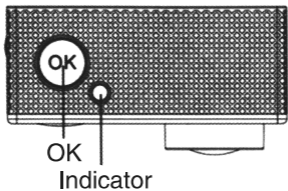

Accessories combination schemes

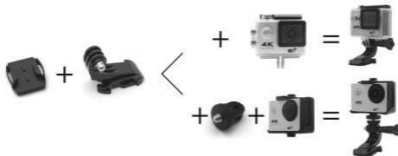
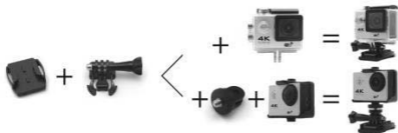

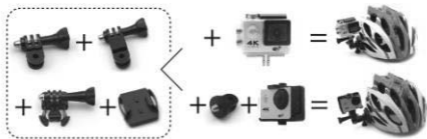
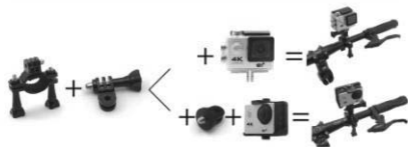
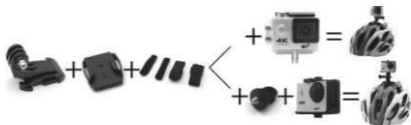
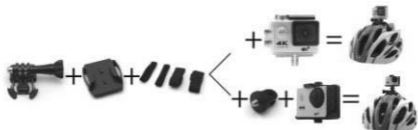

GETTING STARTED

To power ON:

Press the Power/Mode Button.

To power OFF:

Press and hold the Power/Mode Button.

OVERVIEW

Turn camera ON and repeatedly press the Power/Mode Button to cycle through camera modes and settings. The modes will appear in following order:





Video

Record Video



Photo

Capture a single photo



Time-lapse

Time-lapse video



Play back

playback Video and photo



Settings

Adjust camera settings

SETTINGS

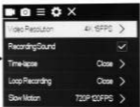

Press the OK Button to enter the settings menu. Repeatedly press the Power/Mode Button to cycle through options and press the OK Button to select desired option.

Video setting

Video Resolution	4K@30FPS/2.7K@30FPS/1080P@60FPS/1080P@30FPS/720P@120FPS
Video sound	ON/OFF
Time-lapse	OFF/0.5S/1S/2S/5S/10S/30S/60S
Loop Recording	OFF/2min/3 min /5 min
Slow motion	1080P@60FPS/720P@120FPS

Photo

Pixel set	16M/12M/8M /5M/2M
Timed	3S/5S/10S/20S/OFF
Auto	3S/10S/15S/20S/30S/OFF
Drama shot	3P/S、 5P/S、 10P/S、 20P/S、 OFF

Exposure	-2---+2
White balance	Auto/Sunny/Cloudy/Incandescent light/Fluorescent light
Image Rotation	ON/OFF
WIFI	ON/OFF
Light source frequency	Auto/50HZ/60HZ

LED indicator light	ON/OFF
Auto screensaver	10S/20S/30S/OFF
Auto shutdown	1min/3min/5min/OFF
Time watermark	ON/OFF

SETTINGS

Language	English/German/French/Spanish/Italian/Portuguese/traditionalChinese,simplifiedChinese/Japanese/Russian language
----------	---

Date-time	2015/01/01 12:00:00
Format	Confirmation/cancel
Reset	Confirmation/cancel
Firmware Version	*****

Micro SD	4K@30FPS/108 0P@60FPS	1080P@30 FPS	720P@60 FPS
32GB	120min	240min	320min
16GB	60min	120min	160min

Video mode

- 1, To record video, Verify the camera is in Video mode.
- 2, If the Video icon " " on screen is showing, press the OK key to start video, at the same time also has "a red icon" flashing.
- 3, Click the OK button again to stop the video, also the red icon disappear.

Picture mode

- 1, To take picture, Verify the camera is in picture mode.
- 2, If the picture icon " " on screen is showing, press the OK key to take pictures.

Slow motion

- 1, To record slow motion video, Verify the camera is in slow motion mode.
- 2, If the slow motion Video icon " " on screen is showing, press the OK key to start video, at the same time also has "a red

icon" flashing.

Time-lapse

1, Enter the setting menu, open this function, return to video mode.

2, If the slow motion Video icon"  " on screen is showing, press the OK key to start video, at the same time also has "a red icon".

Playback

Playing back video and photos

1, verify the camera is in playback menu

2, press up or down button to select file, press OK button to playback video

Battery

1, install and remove the battery

a. down upon battery cover can be open it.

b. according to the battery label plus or minus sign and the direction of the arrow, right put the battery into the camera, until the

installation in position.

c. take out battery, push away the battery cover can take out the battery

2, charge

a. connect the computer or the power adapter can be recharged.

b. directly to the car charger can be recharged in the car.

c. can charge while video function.(inside the function table Settings required to open the car mode)

d. power off can be charged.

CAMERA WIFI APP

1,Download the APP client and install it to the smart phone, which displays the "XDV" application icon after installation. Apple WLAN, direct search "XDV", click install. After the installation of the mobile phone interface will appear a APP application icon. Click to enter the

APP "XDV" interface .

2,The open WIFI function

a. Select the "WIFI" menu, press "OK" button to enter, select "open", the screen will show the WIFI icon, SSID:*****, PWA2:*****.

b. click the UP button to return. At this time to open the phone to set the WIFI function, to find a new set of WIFI name of the network,

c. The connection after entering the new WIFI password and confirm the connection, the connection after the success of the LCD on the Connected/ display MAC:*****.

d. At this time to open the phone has been installed "XDV" APP client, and search to add the camera ID code, after the completion of the camera and video operations can be performed.

Parameter

LCD	2.0LTPS
LENS	170 degree A + high resolution wide Angle lens
Language	English/German/French/Spanish/Italian/Portuguese/traditional Chinese,simplifiedChinese/Japanese/Russian language
video	4K 30FPS 2.7(2688*1520) 30FPS 1080P (1920*1080) 60FPS 720P (1280*720) 120FPS
video format	MP4

compression format	H.264
Photo	16M/14M/12M/8M/5M
Memory	Micro SD UP TO 64GB
Picture mode	Single/timer / (2S/5S/10S) / Continuous shot
Light source frequency	50Hz/60Hz
USB	USB2.0
Power	5V 1A
Battery	900MAH
Video time	1080P/ 90min
Charge time	About 3 hours
System	Windows XP/VistaorAbove/Win7/Mac os

size	59.27*41.13*29.28
WIFI	support

操作注意事項

1. 本產品是高精密產品,請勿摔落或撞擊
2. 請勿將攝像機靠近具有強磁的物體,如磁鐵和電機,另外也要避免將產品靠近發出較強的無線電波的物體,強磁場可能會引起產品故障,或者破壞圖像及聲音.
3. 請勿將攝像機放置在溫度較高或陽光直射的地方
4. 請選擇品牌Micro SD卡,普通卡不能保證能正常使用,
5. 請勿將Micro SD卡存放在或靠近強磁的地方。避免丟失M現過熱,冒煙,或者發出異味,請立即拔出電源,停止充電,避免發生火災。
6. 充電時,請將產品置於兒童無法接觸到的地方,電源線可能會導致兒童意外窒息或受到電擊
7. 請將產品置於陰涼,乾燥且絕塵的地方

產品特性

- > 提供防水功能的防水外殼,方便您拍攝精彩的水上運動,防水外殼可以在深度 30 米处拍攝
- > 超高清顯示幕,顯示和重播拍攝的精彩視頻

>電池可拆卸，方便更換電池，延長使用壽命

>邊充電邊錄影功能

>插電錄影功能

>1600 萬高清廣角鏡頭

>HDMI 高清輸出功能

>網路攝像頭功能

>支援最高 64G 儲存卡

>多種視頻錄製格式

4K@30fps/2K@30fps/1080P60fps/720P@120fps/WVGA

>MOV 格式視頻錄製

>多種拍攝模式 單拍 自動連拍

>超小迷你外觀，多種顏色可選

產品結構

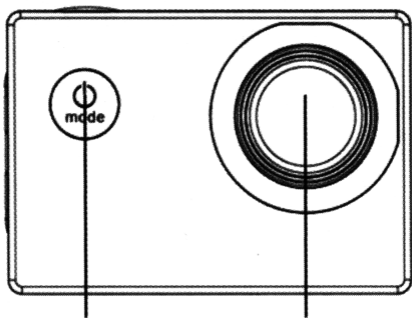

开关键/模式键 镜头

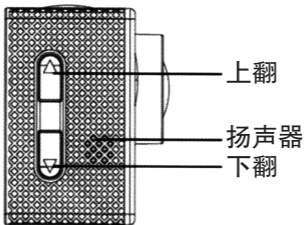
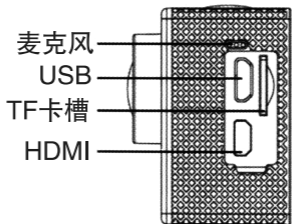

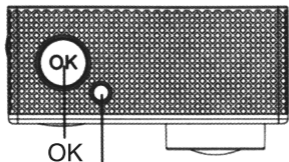

OK
状态指示灯

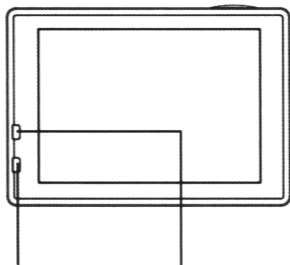

工作指示灯 充电指示灯

配件組合示意图

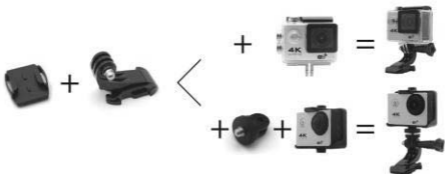
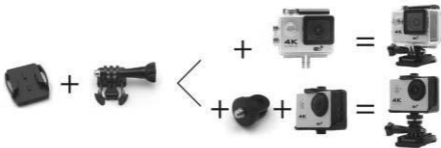

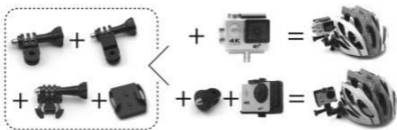
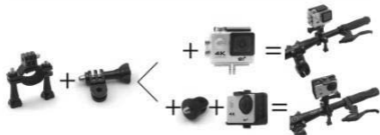
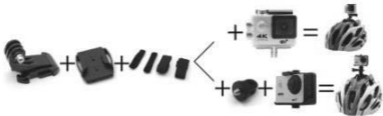
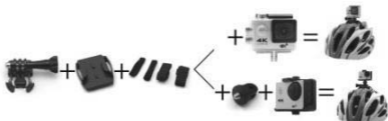

使用操作

開機：

點按開關機/模式鍵，攝像機開機

關機：

長按開關機/模式鍵，攝像機關機

概述

打開攝像機，重複點按開關機/模式鍵，機器會循環攝像機拍攝模式和設置，見下圖：





錄製視頻



拍攝照片



錄製慢動作影像



視頻和照片回放



設置視頻和照片參數等...

設置



開機狀態下，點按开关机/模式鍵，攝像機开机，重複點按开关机/模式鍵進行狀態切換進入設置。

錄像設置：

录像設置	
錄像分辨率	4K@30FPS/2.7K@30FPS/1080P@60FPS /1080P@30FPS/720P@120FPS
錄像聲音	選擇開啟或者關閉
縮時錄影	/0.5S/1S/2S/5S/10S/30S/60S/关闭
循環錄影	關閉/2 分鐘/3 分鐘/5 分鐘
慢攝影	1080P@60FPS/720P@120FPS

拍照設置

像素設置

16M/12M/8M /5M/2M

定時拍照

3S/5S/10S/20S/關閉

自動拍照

3S/10S/15S/20S/30S

運動軌跡拍
照

3P/S、5P/S、10P/S、20P/S

設置

曝光設置

-2---+2

白平衡

自動/晴天/陰天/白熾光/熒光

影像旋轉	開啟/關閉
WIFI 開關	開啟/關閉
光源頻率	自動/50HZ/60HZ
LED 指示燈	開啟/關閉
自動熄屏	10 秒/20 秒/30 秒/關閉
自動關機	1 分鐘/3 分鐘/5 分鐘/關閉
時間水印	開啟/關閉
系統設置	
語言	繁體中文/簡體中文/英文/日本語/韓語/俄語/德語/法語/意大利語/西班牙語/波蘭語/
日期	2015/01/01 12:00:00

格式化	確認/取消
恢復出廠設置	確認/取消
固件版本	*****

錄像時長參考：

Micro SD	4K@30FPS/1080P@60FPS	1080P@30F PS	720P@60F PS
32GB	120min	240min	320min
16GB	60min	120min	160min

录像模式

攝像機進入到攝像模式，螢幕的左上角有  標誌時，按確認鍵開始錄影，錄影的同時螢幕正下方有紅點標誌閃動，再次點按確認鍵停止錄影，同時正下方紅點標誌也消失。

注：攝像機會一直錄像直到機器沒有電，機器關機前，視頻會自動保存到內存卡裡面。

拍照模式

打開電源，攝像默認進入錄像模式，點按模式鍵切換進入拍照模式，

螢幕上左上角有  標誌時，此時進入拍照模式。點按確認鍵進行拍照。

慢攝像

打開電源，攝像默認進入錄像模式，點按模式鍵切換進入拍照模式，再次點按進入慢攝像模式，

此模式下，點按確認鍵，機器錄製高幀率視頻，

註明：慢動作是因为普通电脑显卡还做不到 1 秒播放 120 张，並且播放器本身的解码能力也达不到这么高的要求，所以，播放器会将视频按照 30 帧的速率来播放。例如：120 帧的视频，按照 30 帧来播放，那就相当于放慢了 4 倍，故可以慢動作播放。

縮時錄像

通過打開菜單裡面的縮時錄像功能，設置相應的拍摄时间间隔，設置

完成后，進入攝影模式，按下確認鍵，左下角會有相應的縮時錄像圖標顯示，表明已經在進行縮時錄像。

回放

1. 打開電源，攝像默認進入錄像模式，點按模式鍵切換進入拍照模式，點按兩次進入慢攝像模式
 2. 按上翻鍵和下翻鍵進行文件選擇
 3. 按確認鍵進行視頻播放和暫停
-

電池

1, 安裝和取出電池

A. 向下撥動電池蓋可將它打開。

B. 按照電池上標示的正負符號和箭頭指示方向，正確的把電池裝入攝像機內，直到安裝到位。

C. 取出電池，將電池蓋推開即可取出電池

2, 電池充電

A. 連接電腦和電源適配器均能進行充電。

B. 直接將車充也能在汽車上進行充電。

C. 可邊充電邊錄影功能。(需在功能表裡面設置把車載模式打開)

D. 關機狀態也可以充電。

WI-FI APP 連接

- 1.本機可跟安卓或蘋果系統的手機或者平板電腦通過 WIFI 連接：
 - A. 在手機或平板電腦上安裝 “XDV” APP，（ 安卓系統可在 Google Play 上搜索下載，蘋果系統的可在 APP Store 上搜索下載）。
 - B. 開啟攝像機後，按攝像機上的 WIFI 標示，攝像機的螢幕會顯示 WIFI 標誌，然後出現 ACTION CAM 型號，
 - C. 在手機或者平板電腦上開啟 WIFI 功能，打開手機 WIFI 鏈接，搜索攝像機的王IFI SSID 號，帳號是 ACTION CAM.....然後連接.初始密碼會顯示在主機螢幕上。初始密碼：12345678
 - D. 待成功連接上 WIFI 後,攝像機的螢幕上顯示:WIFI Connection Ready！
 - E. 在手機或平板電腦上運行軟體 “ XDV ” 進入後，攝像機拍攝的畫面即時顯示在手機或平板電腦上。並且可以通過軟體中的相關圖示

操作或者設置攝像機功能參數.

產品參數表

液晶顯示幕	2.0LTPS
鏡頭	170 度 A+級高解析度廣角鏡頭
選擇語言	英文/德文/法文/西班牙文/義大利文/葡萄牙文/繁體中文/簡體中文/日文/俄文
錄影視頻	4K 30FPS 2.7(2688*1520) 30FPS 1080P (1920*1080) 60FPS 720P (1280*720) 120FPS
錄影視頻格式	MP4
視訊壓縮格式	H.264
相片解析度	16M/14M/12M/8M/5M
存儲卡	Micro SD UP TO 64GB

拍照模式	單拍/定時自拍/(2 秒/5 秒/10 秒)/連拍
光源頻率	50Hz/60Hz
USB	USB2.0
電源	5V 1A
電池容量	900MAH
功耗	400mA@4.2V
錄影時間	1080P/ 90 分鐘左右
充電時間	約 3 小時
作業系統	Windows XP/Vista or Above/Win7/Mac os
外形尺寸	59.27*41.13*29.28
WIFI	支持

簡易問題描述以及解決辦法

1.當產品操作不當引起死機現象

可拆卸電池重新安裝，本機可以恢復正常

2.本機最大支持 64G Micro SD 卡，請選擇品牌的 Micro SD 卡，在電腦上格式化後再使用通中性卡不能保證能正常使用工作。

3.什麼是縮時錄像？

即通过设置一定的拍摄时间间隔，对同一场景或同一物体以一定拍摄频率自动进行长时间连续拍摄，形成一帧帧由成千上万张照片组合而成的连续画面，并自动将其加工为动画视频从而将一些需要长时间才能完成的过程浓缩为几分钟的影像呈现出来。免去长时间摄影的不便。

